

LM4921

*LM4921 Low Voltage I2S 16-Bit Stereo DAC with Stereo Headphone Power
Amplifiers and Volume Control*



Literature Number: SNAS178D

www.BDTIC.com/TI

LM4921 Boomer® Audio Power Amplifier Series

Low Voltage I²S 16-Bit Stereo DAC with Stereo Headphone Power Amplifiers and Volume Control

General Description

The LM4921 combines a 16-bit resolution stereo I²S input digital-to-analog converter (DAC) with a stereo headphone audio power amplifier. It is primarily designed for demanding applications in mobile phones and other portable communication device applications. The LM4921 features an I²S serial interface for the digital audio information and a 16-bit SPI serial interface for internal register control and communication. With AV_{DD} and $DV_{DD} = 3.0V_{DC}$ and driving a 32Ω single-ended load to a $26mW_{RMS}$ output level the distortion (THD+N) of the LM4921 will be less than 0.5%. The LM4921 also features a programmable 32-step digital volume control accessed through an SPI interface.

Boomer audio power amplifiers were designed specifically to provide high quality output power with a minimal amount of external components. It is, therefore, ideally suited for mobile phone and other low voltage applications where minimal power consumption is a primary requirement.

The LM4921 features a low-power consumption shutdown mode, and also has an internal thermal shutdown protection mechanism.

Key Specifications

■ PSRR at 217Hz, $A/DV_{DD} = 3V$, (Fig. 1)	52dB (typ)
■ P_{OUT} at $AV_{DD} = 3.0V$, 32Ω	
< 0.05% THD	13mW (typ)
< 0.5% THD	26mW (typ)
■ Supply voltage range	
DV_{DD}	2.6V to 5.0V
AV_{DD} (Note 8)	2.6V to 5.5V
■ Shutdown current	1 μ A (typ)

Features

- 16-bit resolution stereo DAC
- I²S digital audio data serial interface
- SPI serial interface (control register)
- Volume Control (32 steps; 1.5 dB increments)
- Up to 50mW/channel stereo headphone amplifier
- Zero Crossing Detection for Silent Attenuation Steps
- $2.6V_{DC}$ to $5.0V_{DC}$ digital supply voltage range
- $2.6V_{DC}$ to $5.5V_{DC}$ analog supply voltage range (Note 8)
- Unity-gain stable headphone amplifiers
- Available in the 20-bump microSMD package

Applications

- Mobile phones
- PDAs
- Portable electronic devices

Typical Application

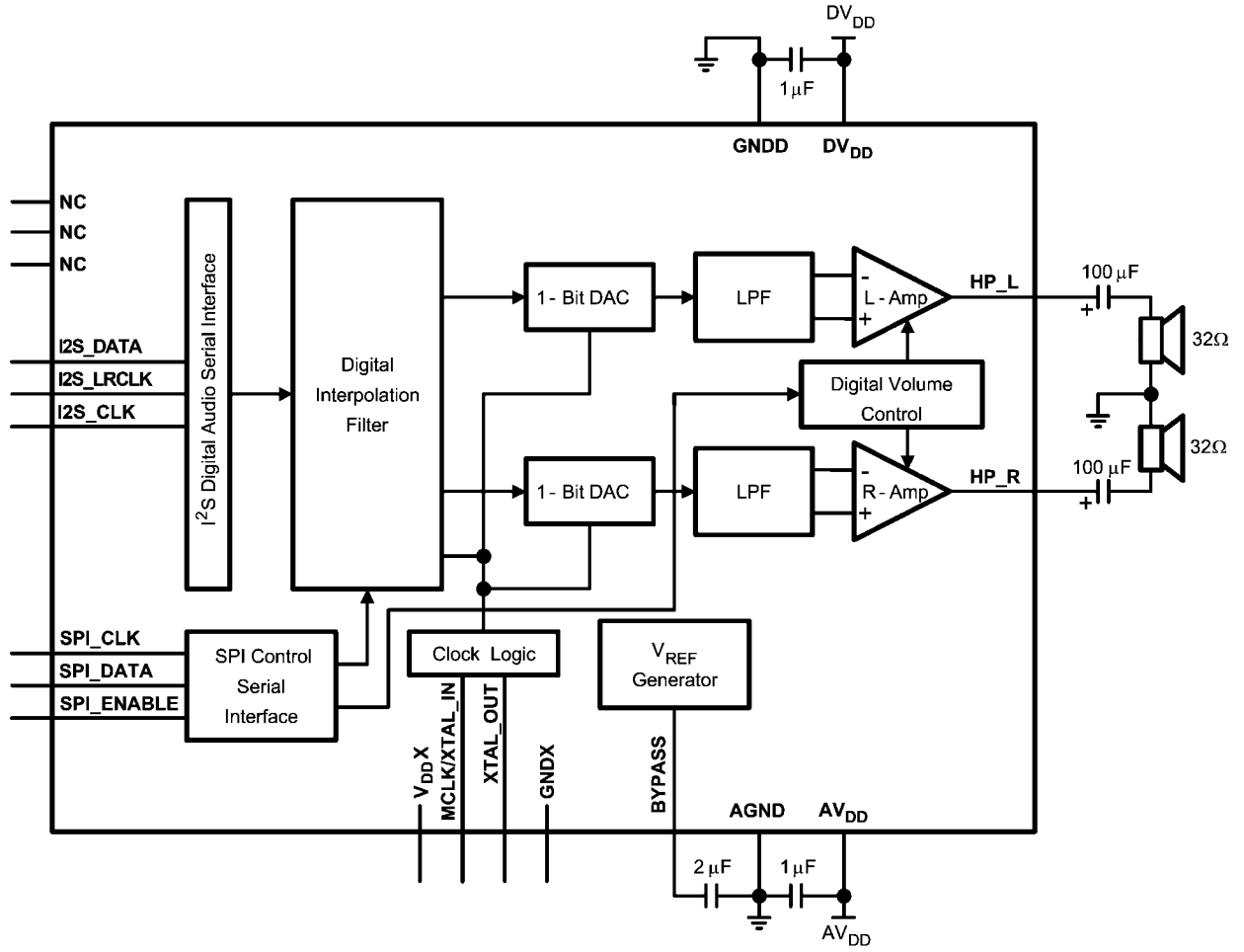

20048616

FIGURE 1. Typical Audio Amplifier Application Circuit

Connection Diagrams

LM4921 Pin Configuration

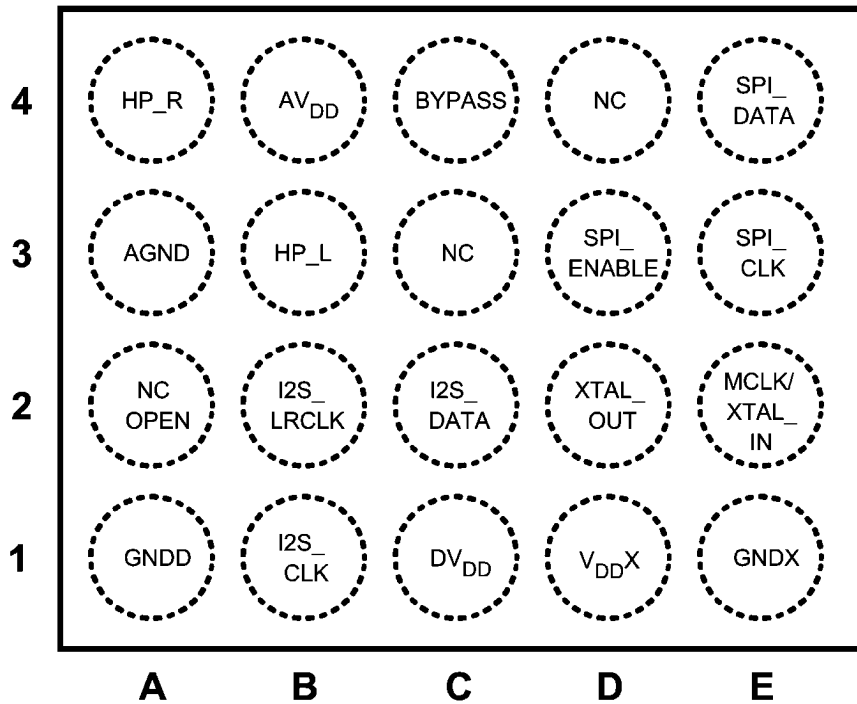

20048618

Top View
 20-Bump micro SMD
 Order Number LM4921ITL, LM4921ITLX
 See NS Package Number TLA20JKA
 NC - No Connection

20-Bump micro SMD Marking

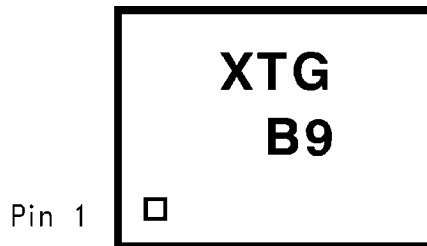

20048619

X - Date Code
 T - Die Traceability
 G - Boomer Family
 B9 - LM4921ITL

LM4921 I/O Pin Descriptions

PIN # (ITL)	PIN NAME	PIN TYPE Input-I, Output-O, Power-P, No Connect-NC	PIN DESCRIPTION
B1	I2S_CLK	I/O	I2S Clock
C2	I2S_DATA	I	I2S data
B2	I2S_WS	I/O	I2S L/R word select
E3	SPI_CLK	I	SPI clock
E4	SPI_DATA	I	SPI data
D3	SPI_ENABLE	I	SPI Enable
E2	MCLK/XTAL_IN	I	Master Clock / Xtal input
D2	XTAL_OUT	O	Xtal output
C4	BYPASS	I/O	Analog VDD/2 bypass capacitor connection point
B4	AV _{DD}	P	Analog supply
A3	AGND	P	Analog Ground
C1	DV _{DD}	P	Digital Supply
A1	GNDD	P	Digital ground
D1	VDDX	P	XTAL Oscillator circuit supply
E1	GNDX	P	XTAL Oscillator circuit ground
B3	HP_L	O	HP left output
A4	HP_R	O	HP right output
A2	No Connect	O	Must let float
C3	No Connect	NC	NC
D4	No Connect	NC	NC

Absolute Maximum Ratings (Notes 1, 2)

If Military/Aerospace specified devices are required, please contact the National Semiconductor Sales Office/ Distributors for availability and specifications.

Supply Voltage	6.0V
Storage Temperature	-65°C to +150°C
Input Voltage	-0.3V to $V_{DD} + 0.3V$
Power Dissipation (Note 3)	Internally Limited
ESD Susceptibility	
Human body model (Note 4)	2000V
Machine model (Note 5)	200V

Junction Temperature	150°C
Thermal Resistance	
θ_{JA}	60°C/W

Operating Ratings

Temperature Range	
$T_{MIN} \leq T_A \leq T_{MAX}$	-40°C \leq T_A \leq 85°C
Supply Voltage	
DV_{DD}	2.6V \leq DV_{DD} \leq 5.0V
AV_{DD}	2.6V \leq AV_{DD} \leq 5.5V

Electrical Characteristics $DV_{DD} = 3.0V$, $AV_{DD} = 5.0V$, $R_L = 32\Omega$ (Notes 1, 2)
The following specifications apply for the circuit shown in Figure 1 unless otherwise specified. Limits apply for $T_A = 25^\circ\text{C}$.

Symbol	Parameter	Conditions	LM4921		Units (Limits)
			Typical	Limit	
			(Note 6)	(Notes 7, 9)	
DV_{DD}	Digital Power Supply Voltage	Note 8	3.0		V
AV_{DD}	Analog Power Supply Voltage	Note 8	5.0		V
DI_{DD}	Digital Power Supply Quiescent Current	$R_{Load} = \infty$, $f_{MLCK} = 11.2896\text{MHz}$	3.5	7.5	mA (max)
AI_{DD}	Analog Power Supply Quiescent Current	$R_{Load} = \infty$, $f_{MCLK} = 0\text{MHz}$	6	10	mA (max)
I_{SD}	Total Shutdown Power Supply Current	SHUTDOWN SPI bits 1 & 2 set to logic 0, SPI, M_{CLK} and I ² S inputs at GND	1	5	μA (max)
I_{SB}	Standby Current	Analog and Digital together All clocks off	25		μA
V_{FS}	Full-Scale Output Voltage	Gain set at max	3.5		V_{P-P}
THD+N	Total Harmonic Distortion + Noise	$f_{IN} = 1\text{kHz}$, $P_{OUT} = 12\text{mW}$ (Vol Control = 11111, I ² S input adj to get 12mW at output)	0.03		%
P_O	Headphone Amplifier Output Power	THD = (0.5%), $f_{OUT} = 1\text{kHz}$	50	40	mW (min)
PSRR	Power Supply Rejection Ratio	$AV_{DD} C_{BYPASS} = 2.0\mu\text{F}$ $V_{RIPPLE} = 200\text{mV}_{P-P} 217\text{Hz}$	62	45	dB (min)
SNR	Signal-to-Noise Ratio	$f_{IN} = 1\text{kHz}$ sinewave at -60dB _{FS} , A-weighted- $f_{CONV} = 44.1\text{kHz}$	82		dB
DR	Dynamic Range	$f_{IN} = 1\text{kHz}$ sinewave at -60dB _{FS} , A-weighted	84		dB
ΔA_{CH-CH}	Channel-to-Channel Gain Mismatch	$f_{IN} = 1\text{kHz}$	0.06		dB
X_{TALK}	Channel-to-Channel Crosstalk	$f_{CONV} = 44.1\text{kHz}$, $f_{IN} = 1\text{kHz}$ sinewave at -3dB _{FS}	72		dB
	Volume Control Range	Minimum Attenuation Maximum Attenuation	+3.0 -43.5		dB dB
	Volume Control Control Step Size		1.5		dB
	Mute Attenuation		-102		dB

Electrical Characteristics $DV_{DD} = 3.0V$, $AV_{DD} = 3.0V$, $R_L = 32\Omega$ (Notes 1, 2)
 The following specifications apply for the circuit shown in Figure 1 unless otherwise specified. Limits apply for $T_A = 25^\circ C$.

Symbol	Parameter	Conditions	LM4921		Units (Limits)
			Typical	Limit	
			(Note 6)	(Notes 7, 9)	
DV_{DD}	Digital Power Supply Voltage	Note 8	3.0		V
AV_{DD}	Analog Power Supply Voltage	Note 8	3.0		V
DI_{DD}	Digital Power Supply Quiescent Current	$R_{Load} = \infty$, $f_{MCLK} = 11.2896MHz$	3.5	7.5	mA (max)
AI_{DD}	Analog Power Supply Quiescent Current	$R_{Load} = \infty$, $f_{MCLK} = 0MHz$	5	9.0	mA (max)
I_{SD}	Total Shutdown Power Supply Current	SHUTDOWN SPI bits 1 & 2 set to logic 0, SPI, M_{CLK} and I ² S inputs at GND	1		uA(max)
I_{SB}	Standby Current	Analog and Digital together All clocks off	15		uA
V_{FS}	Full-Scale Output Voltage	Gain set at max	2.6		V_{P-P}
THD+N	Total Harmonic Distortion + Noise	$f_{IN} = 1kHz$, $P_{OUT} = 12mW$ (Vol Cont = 11011, I ² S input adj to get 12mW at output)	0.05		%
P_O	Headphone Amplifier Output Power	THD = (0.5%), $f_{OUT} = 1kHz$	26		mW (min)
PSRR	Power Supply Rejection Ratio	$AV_{DD} C_{BYPASS} = 2.0\mu F$ $V_{RIPPLE} = 200mV_{P-P} 217Hz$	52		dB (min)
SNR	Signal-to-Noise Ratio	$f_{IN} = 1kHz$ sinewave at $-60dB_{FS}$, A-weighted- $f_{CONV} = 44.1kHz$	79		dB
DR	Dynamic Range	$f_{IN} = 1kHz$ sinewave at $-60dB_{FS}$, A-weighted	81		dB
ΔA_{CH-CH}	Channel-to-Channel Gain Mismatch	$f_{IN} = 1kHz$	0.06		dB
X_{TALK}	Channel-to-Channel Crosstalk	$f_{CONV} = 44.1kHz$, $f_{IN} = 1kHz$ sinewave at $-3dB_{FS}$	72		dB
	Volume Control Range	Minimum Attenuation Maximum Attenuation	0 -43.5		dB dB
	Volume Control Control Step Size		1.5		dB
	Mute Attenuation		-100		dB

Electrical Characteristics-Digital Inputs $DV_{DD} = 3.0V$ (Notes 1, 2)

The following specifications apply for the circuit shown in Figure 1 unless otherwise specified. Limits apply for $T_A = 25^\circ C$.

Symbol	Parameter	Conditions	LM4921		Units (Limits)
			Typical	Limit	
			(Note 6)	(Notes 7, 9)	
	Resolution		16		Bits
I ² S	Audio Data Interface Format	Standard, I ² S, Left Justified			
f _{MCLK}	Master Clock Frequency		11.2896 (256FS)		MHz
f _{CONV}	Sampling Clock Frequency Range		44.1	48	kHz
V _{IL}	Digital Input: Logic Low Voltage Level			0.3 X DV _{DD}	V (max)
V _{IH}	Digital Input: Logic High Voltage Level			0.7 X DV _{DD}	V (min)
t _{ES}	SPI_ENB Setup Time			20	ns (min)
t _{EH}	SPI_ENB Hold Time			20	ns (min)
t _{EL}	SPI_ENB Low Time			30	ns (min)
t _{DS}	SPI_Data Setup Time			20	ns (min)
t _{DH}	SPI_Data Hold Time			20	ns (min)
t _{CS}	SPI_CLK Setup Time			20	ns (min)
t _{CH}	SPI_CLK High Pulse Width			100	ns (min)
t _{CL}	SPI_CLK Low Pulse Width			100	ns (min)
f _{CLK}	SPI_CLK Frequency			5	MHz (max)
t _{CLKI²S}	I ² S_CLK Period			50	ns (min)
t _{HII²S}	I ² S_CLK High Pulse Width			20	ns (min)
t _{LOI²S}	I ² S_CLK Low Pulse Width			20	ns (min)
	I ² S_LRCLK Duty Cycle		50		%
t _{SLRCLK}	I ² S_LRCLK to I ² S_CLK Setup Time			20	ns (min)
t _{HLRCLK}	I ² S_LRCLK to I ² S_CLK Hold Time			20	ns (min)
t _{SDI²S}	I ² S_Data to I ² S_CLK Setup Time			20	ns (min)
t _{HDI²S}	I ² S_Data to I ² S_CLK Hold Time			20	ns (min)

Note 1: *Absolute Maximum Ratings* indicate limits beyond which damage to the device may occur. *Operating Ratings* indicate conditions for which the device is functional, but do not guarantee specific performance limits. *Electrical Characteristics* state DC and AC electrical specifications under particular test conditions which guarantee specific performance limits. This assumes that the device is within the Operating Ratings. Specifications are not guaranteed for parameters where no limit is given, however, the typical value is a good indication of device performance.

Note 2: All voltages are measured with respect to the GND pin, unless otherwise specified.

Note 3: The maximum power dissipation must be derated at elevated temperatures and is dictated by T_{JMAX} , θ_{JA} , and the ambient temperature T_A . The maximum allowable power dissipation is $P_{DMAX} = (T_{JMAX} - T_A) / \theta_{JA}$ or the number given in Absolute Maximum Ratings, whichever is lower.

Note 4: Human body model, 100pF discharged through a 1.5k Ω resistor.

Note 5: Machine Model, 220pF – 240pF discharged through all pins.

Note 6: Typicals are measured at 25°C and represent the parametric norm.

Note 7: Limits are guaranteed to National's AOQL (Average Outgoing Quality Level).

Note 8: Best operation is achieved by maintaining $3.0V \leq AV_{DD} \leq 5.0V$ and $3.0V \leq DV_{DD} \leq 5.0V$.

Note 9: Datasheet min/max specification limits are guaranteed by design, test, or statistical analysis.

Typical Performance Characteristics

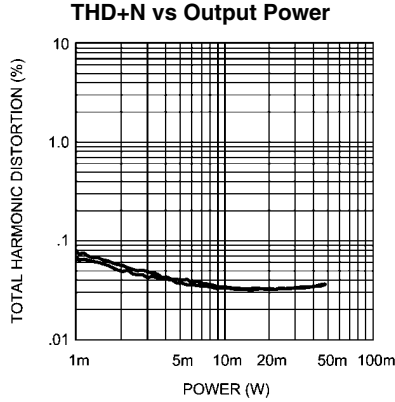

200486g9
Analog $V_{DD} = 5V$, Digital $V_{DD} = 3V$
 $R_L = 32\Omega$, 44.1 kHz Sample Rate
R & L Channels, Vol = 3dB, Frequency in = 1kHz

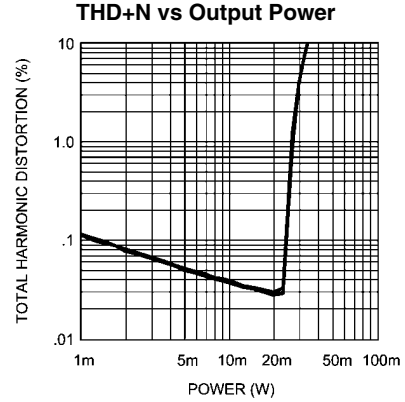

200486g8
Analog $V_{DD} = 3V$, Digital $V_{DD} = 3V$
 $R_L = 32\Omega$, 44.1 kHz Sample Rate
R & L Channels Shown, Vol = 3dB, Frequency in = 1kHz

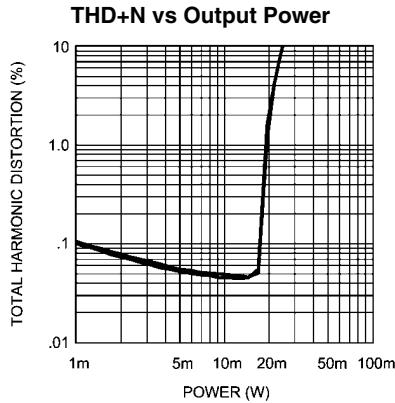

200486g7
Analog $V_{DD} = 2.6V$, Digital $V_{DD} = 2.6V$
 $R_L = 32\Omega$, 44.1 kHz Sample Rate
R & L Channels Shown, Vol = 3dB, Frequency in = 1kHz

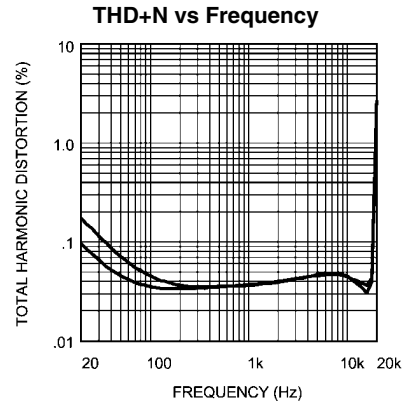

200486g6
Analog $V_{DD} = 5V$, Digital $V_{DD} = 3V$
 $R_L = 32\Omega$, Power Level = 50mW
R & L Channels Shown, 44.1kHz Sample Rate

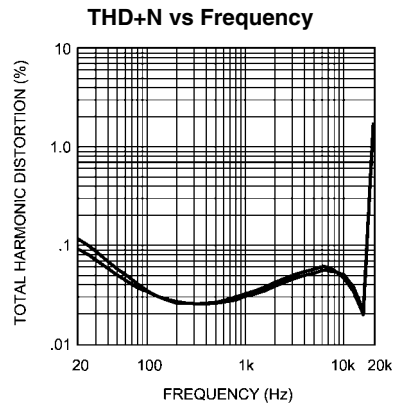

200486g5
Analog $V_{DD} = 3V$, Digital $V_{DD} = 3V$
 $R_L = 32\Omega$, Power Level = 12mW
R & L Channels Shown, 44.1kHz Sample Rate

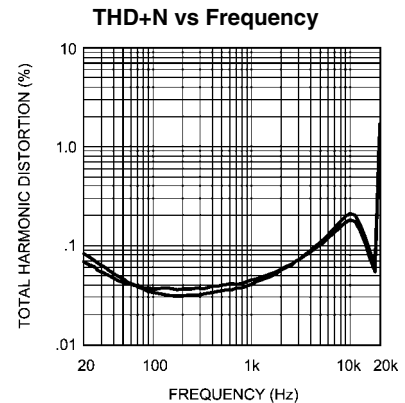

200486g4
Analog $V_{DD} = 2.6V$, Digital $V_{DD} = 2.6V$
 $R_L = 32\Omega$, Power Level = 12mW
R & L Channels Shown, 44.1kHz Sample Rate

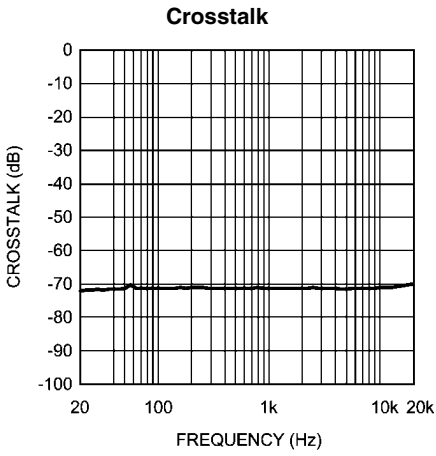

^{200486c7}
Analog $V_{DD} = 3V$, Digital $V_{DD} = 3V$
 $R_L = 32\Omega$, Vol = 3dB
44.1kHz Sample Rate, -3dB FFS

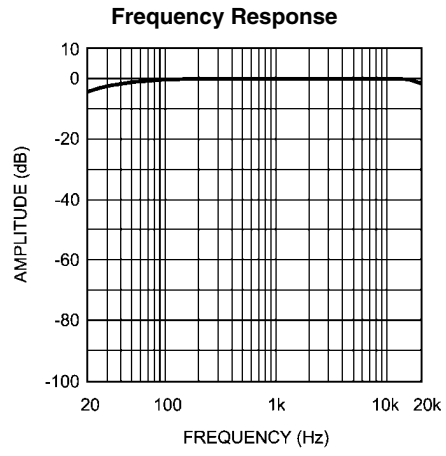

^{200486e1}
Analog $V_{DD} = 5V$, Digital $V_{DD} = 3V$
 $R_L = 32\Omega$, Vol = 0dB
44.1kHz Sample Rate, 0dB FFS

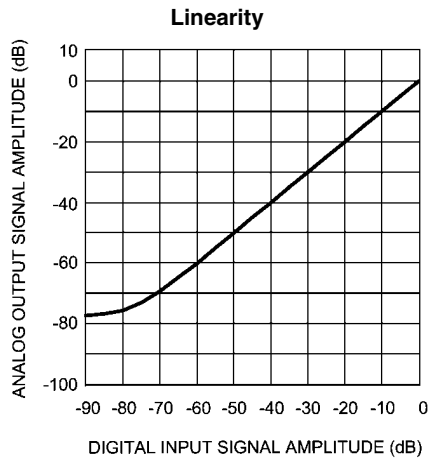

^{200486e3}
Analog $V_{DD} = 5V$, Digital $V_{DD} = 3V$
 $R_L = 32\Omega$, 44.1kHz Sample Rate

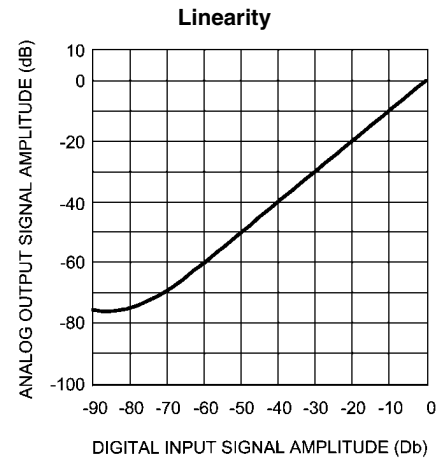

^{200486e2}
Analog $V_{DD} = 3V$, Digital $V_{DD} = 3V$
 $R_L = 32\Omega$, 44.1kHz Sample Rate

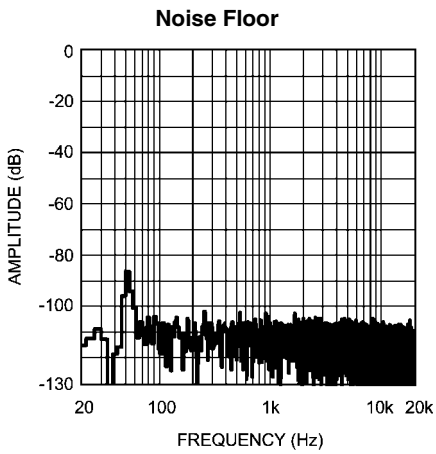

^{200486f0}
Analog $V_{DD} = 5V$, Digital $V_{DD} = 3V$
 $R_L = 32\Omega$, Vol = 3dB, 44.1kHz Sample Rate

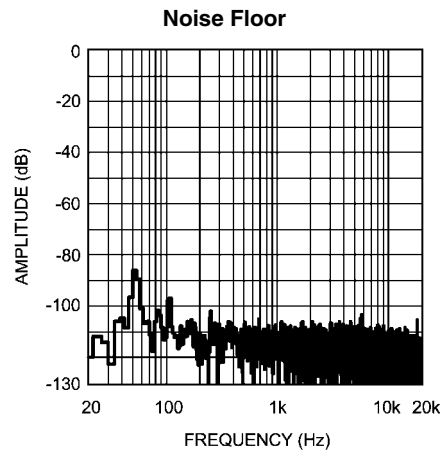

^{200486e9}
Analog $V_{DD} = 3V$, Digital $V_{DD} = 3V$
 $R_L = 32\Omega$, Vol = 0dB, 44.1kHz Sample Rate

PSRR vs Frequency

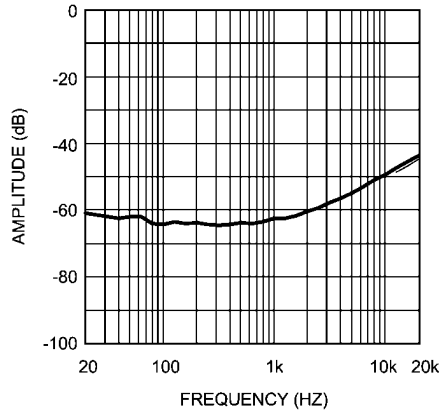

200486g3
Analog $V_{DD} = 5V$, Digital $V_{DD} = 3V$
 $R_L = 32\Omega$, Vol = 3dB, 44.1kHz Sample Rate

PSRR vs Frequency

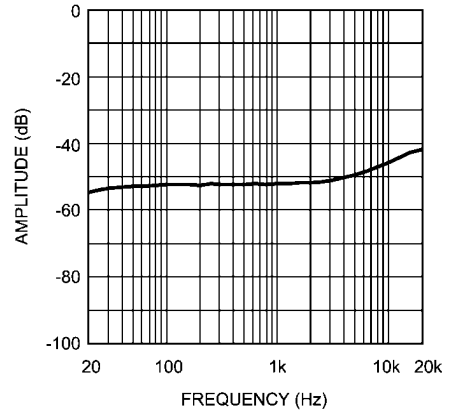

200486e7
Analog $V_{DD} = 3V$, Digital $V_{DD} = 3V$
 $R_L = 32\Omega$, Vol = 0dB, 44.1kHz Sample Rate

FFT @ 1kHz -60dB

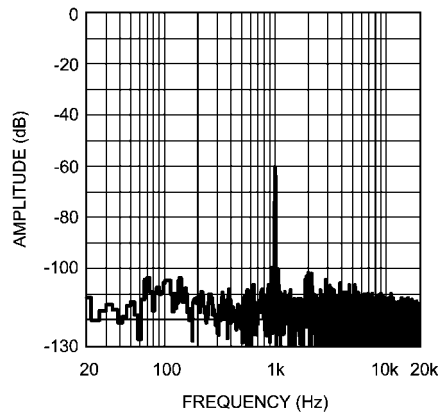

200486d1
Analog $V_{DD} = 5V$, Digital $V_{DD} = 3V$
 $R_L = 32\Omega$, Vol = 3dB, 44.1kHz Sample Rate

FFT @ 1kHz 0dB

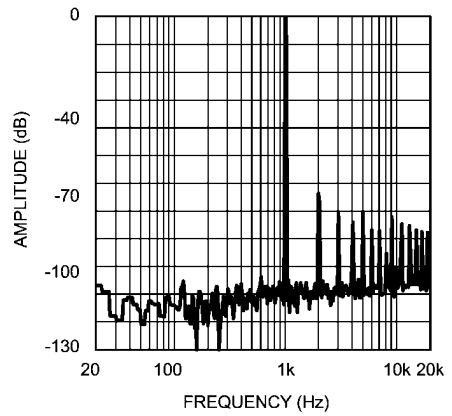

200486c9
Analog $V_{DD} = 5V$, Digital $V_{DD} = 3V$
 $R_L = 32\Omega$, Vol = 3dB, 44.1kHz Sample Rate

FFT @ 1kHz -60dB

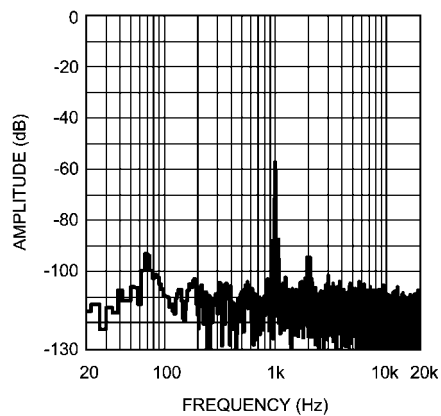

200486d0
Analog $V_{DD} = 3V$, Digital $V_{DD} = 3V$
 $R_L = 32\Omega$, Vol = 0dB, 44.1kHz Sample Rate

FFT @ 1kHz 0dB

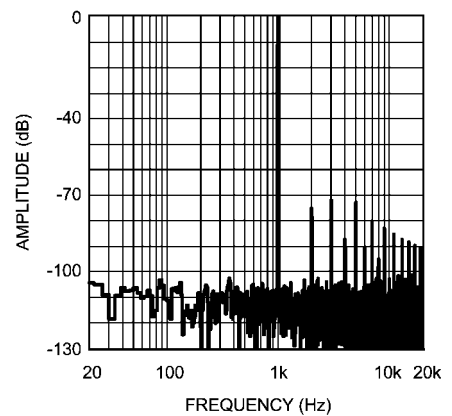

200486f7
Analog $V_{DD} = 3V$, Digital $V_{DD} = 3V$
 $R_L = 32\Omega$, Vol = 0dB, 44.1kHz Sample Rate

Application Information

SPI OPERATIONAL DESCRIPTION

The serial data bits are organized into a field which contains 16 bits of data defined by TABLE 1. Bits 1 & 2 determine the output mode of the LM4921 as shown in TABLE 2. Bits 7 through 11 determine the volume level setting as illustrated by TABLE 3. Bit 12 sets the Bypass capacitor charging time.

Table 1. Bit Allocation

BIT #	Default Val	Function	Description
0 (LSB)	0	RESET_B	RESET_B = 0, Resets the DAC Must be high for the part to run.
1	0	MODE CONTROL	See Table 2
2	0		
3	0	MASTER/SLAVE	0 = SLAVE, 1 = MASTER
4	0	RESOLUTION	0 = 16 bit, 1 = 32 bit
5	0	RESERVED	Should always be set to '1'
6	0	ZERO CROSSING SET	0 = ZXD ENABLE, 1 = ZXD DISABLE
7	0	VOLUME CONTROL	See Table 3 - Volume Control Settings
8	0		
9	0		
10	0		
11	0		
12	0	BYP CHARGE RATE	0 = 1X, 1 = 2X
13	0	RESERVED	
14	0	RESERVED	
15 (MSB)	0	RESERVED	Should always be set to '0'

MODE CONTROL

Sets the modes as outlined in Table 2.

Table 2. Output Mode Selection (Bits 1 & 2 above)

Output Mode #	BIT 2	BIT 1	MODE
0	0	0	SD
1	0	1	STANDBY
2	1	0	MUTE
3	1	1	ACTIVE

Shutdown turns off the part completely for maximum power savings. The Standby mode turns off the clock but still consumes more power than the shutdown mode. However, coming out of standby mode allows the part to turn back on faster than from shutdown. In Mute mode the clocks remain on which uses more power but allows faster recovery and the ability to supply clock signals to other devices which is important when the part is used in master mode. Active mode turns the part on for normal operation.

MASTER/SLAVE SELECT

Allows the part to act as a master and supply the clock for the rest of the system or be a slave to the system clock.

RESOLUTION SET

Sets the resolution to be either 16 or 32 bits of stereo audio information. For most applications this will be set at 16 bits.

ZERO CROSSING DETECT SET

This pin turns on the zero crossing detection circuit. With this circuit enabled the part will not allow a volume step change, or shutdown mode, or standby mode to occur until the audio input signal passes through zero. This pin should be set to on for most applications.

VOLUME CONTROL

The internal Stereo Volume Control is set by changing bits 7 through 11 in the SPI interface, as shown in table 3 below. The zero dB setting is for 3V VDD operation and the +3dB is for 5V VDD.

Table 3. Volume Control Settings

Gain (dB) HP_L & HP_R	Bit 11	Bit 10	Bit 9	Bit 8	Bit 7
-43.5	0	0	0	0	0
-42.0	0	0	0	0	1
-40.5	0	0	0	1	0
-39.0	0	0	0	1	1
-37.5	0	0	1	0	0
-36.0	0	0	1	0	1
-34.5	0	0	1	1	0
-33.0	0	0	1	1	1
-31.5	0	1	0	0	0
-30.0	0	1	0	0	1
-28.5	0	1	0	1	0
-27.0	0	1	0	1	1
-25.5	0	1	1	0	0
-24.0	0	1	1	0	1
-22.5	0	1	1	1	0
-21.0	0	1	1	1	1
-19.5	1	0	0	0	0
-18.0	1	0	0	0	1
-16.5	1	0	0	1	0
-15.0	1	0	0	1	1
-13.5	1	0	1	0	0
-12.0	1	0	1	0	1
-10.5	1	0	1	1	0
-9.0	1	0	1	1	1
-7.5	1	1	0	0	0
-6.0	1	1	0	0	1
-4.5	1	1	0	1	0
-3.0	1	1	0	1	1
-1.5	1	1	1	0	0
0.0	1	1	1	0	1
1.5	1	1	1	1	0
3.0	1	1	1	1	1

BYPASS CHARGE RATE BIT 12

This control pin allows the user to change the Bypass Capacitor's charge rate by a factor of two. Setting this bit at zero will set the circuit to its normal 1x rate. Setting the bit to High will double the charge rate and allow the part to turn on faster with a slight degradation in turn on click/pop noise.

SPI CONTROL INTERFACE BUS (J1)

SPI DATA: This is the serial data pin.

SPI CLK: This is the clock input pin.

SPI ENABLE: This is the SPI enable pin.

BITS 5, 13,14, and 15

Bits 13, 14, and 15 are all reserve bits and must be set to low/zero/ground.

Bit 5 must be set High.

SPI TIMING DIAGRAM

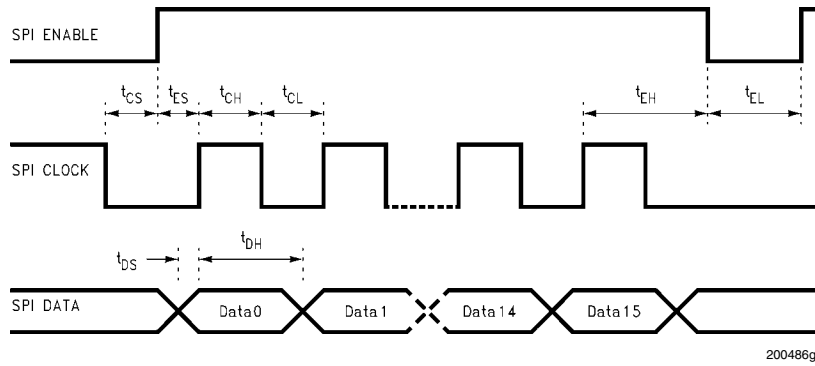

200486g1

SPI OPERATIONAL REQUIREMENTS

1. The maximum clock rate is 5MHz for the CLK pin.
2. CLK must remain logic-high for at least 100ns (t_{CH}) after the rising edge of CLK, and CLK must remain logic-low for at least 100ns (t_{CL}) after the falling edge of CLK.
3. Data bits are written to the DATA pin with the least significant bit (LSB) first.
4. The serial data bits are sampled at the rising edge of CLK. Any transition on DATA must occur at least 20ns (t_{DS}) before the rising edge of CLK. Also, any transition on DATA must occur at least 20ns (t_{DH}) after the rising edge of CLK and stabilize before the next rising edge of CLK.
5. ENABLE should be logic-high only during serial data transmission.
6. ENABLE must be logic-high at least 20ns (t_{ES}) before the first rising edge of CLK, and ENABLE has to remain logic-high at least 20ns (t_{EH}) after the sixteenth rising edge of CLK.
7. If ENABLE remains logic-low for more than 10ns before all 16 bits are transmitted then the data latch will be aborted.
8. If ENABLE is logic-high for more than 16 CLK pulses then only the first 16 data bits will be latched and activated at rising edge of sixteenth CLK.
9. ENABLE must remain logic-low for at least 30ns (t_{EL}).
10. Coincidental rising or falling edges of CLK and ENABLE are not allowed. If CLK is to be held logic-high after the data transmission, the falling edge of CLK must occur at least 20ns (t_{CS}) before ENABLE transitions to logic-high for the next set of data.

I2S INTERFACE BUS (J2 - Fig 2)

The I2S standard provides a uni-directional serial interface designed specifically for digital audio. For the LM4921, the

interface provides access to a 48kHz, 16 bit full-range stereo audio DAC. This interface uses a three wire system of clock (I2S_CLK), data (I2S_DATA), and word select (I2S_WS, sometimes called Right/Left Select).

A bit clock (I2S_CLK) at 32 or 64 times the sample frequency is established by the I2S system master and the word select (I2S_WS) line is driven at a frequency equal to the sampling rate of the audio data, in this case 48kHz. The word line is registered to change on the positive edge of the bit clock. The serial data (I2S_DATA) is sent MSB first, again registers on the positive edge of the bit clock, delayed by 1 bit clock cycle relative to the changing of the word line (typical I2S format).

MCLK/XTAL_IN (S1 MCLK SEL - Fig 2)

This is the input for an external Master Clock. The jumper at S1 must be removed (disconnecting the onboard crystal from the circuit) when using an external Master Clock.

STEREO HEADPHONE OUTPUT JACK (J3 - Fig 2)

This is the stereo headphone output. Each channel is single-ended, with 100uF DC output blocking capacitors mounted on the demo board (C6 and C7). These capacitors are necessary to block the 1/2 VDD DC bias and prevent it from flowing through the headphone speakers (DC current will destroy most audio speakers) while allowing the audio ac signal to pass through. The jack features a typical stereo headphone pinout.

LM4921ITL DEMO BOARD OPERATION

The LM4921ITL demo board is a complete evaluation platform (Note 10), designed to give easy access to the control pins of the part and comprise all the necessary external passive components. There are separate analog and digital supply connectors, SPI interface bus (J1) for the control lines, I²S interface bus (J2) for full-range digital audio, stereo headphone output (J3), and an external MCLK input (P1) for use in place of the crystal on the demoboard.

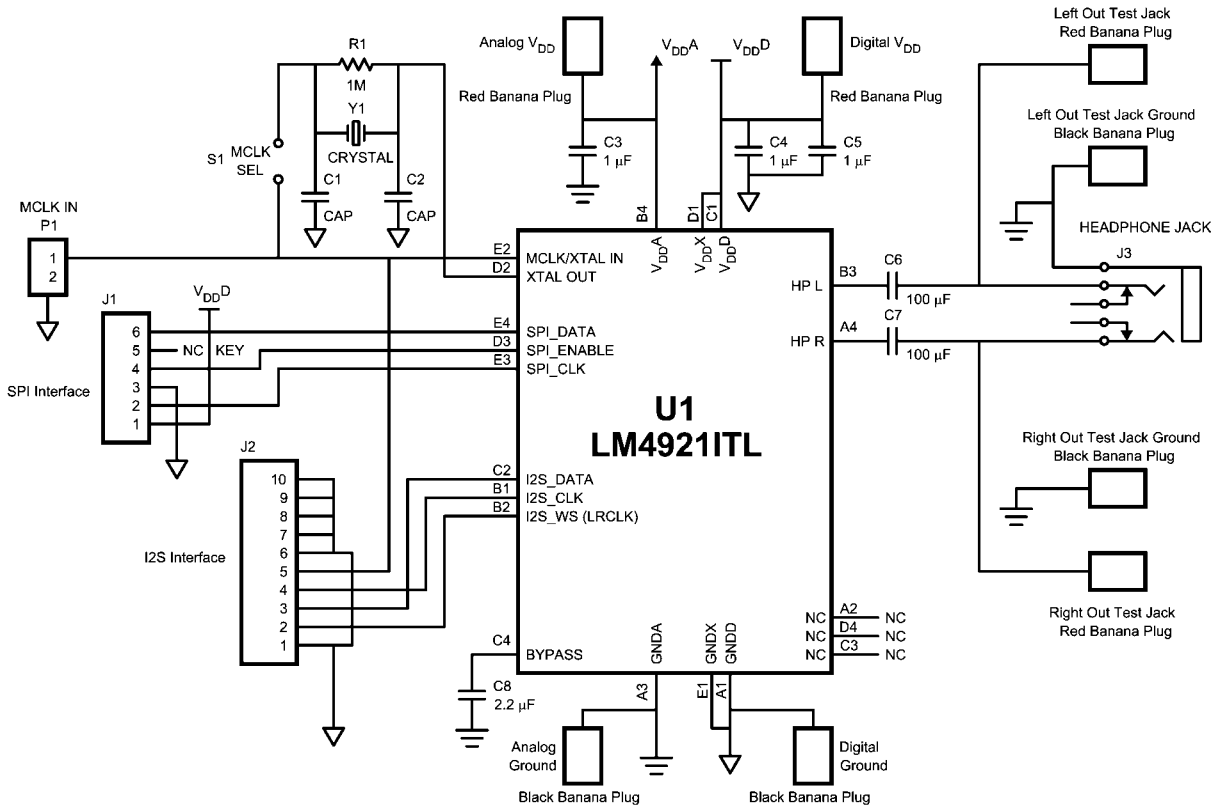

200486g2

FIGURE 2. LM4921ITL Demo Board Schematic

Note 10: Parallel Port SPI Interface Card and control software available.

DEMO BOARD BILL OF MATERIALS

National Semiconductor Corporation Bill of Material				
Analog Audio LM4921ITL20 Eval Board				
Assembly Part Number: 980011973-100				
Revision A				
Item	Part Number	Part Description	Qty	Ref Designator
1	551011973-001	LM4921 Eval Board PCB etch 001	1	
2		LM4921 ITL20 micro SMD 20 Bumps	1	U1
3		Cer Cap 22pF 50V 10%, size 1206	2	C1, C2
4		Cer Cap 0.1pF 50V 10%, size 1206	1	C4
5		Tant Cap 1 μ F 16V 10%, 3216	3	C3, C5, C8
6		Tant Cap 220 μ F 16V 10%, 7243	2	C6, C7
7		1 meg ohm	1	R1
8		Crystal 11.2896MHz	1	Y1
9		Phone Jack 3.5mm Stereo	1	J3
10		Jumper Header 1X2	2	P1, S1
11		Jumper Header 1X3	2	J1
12		Jumper Header 1X5	2	J2
13		PCB Banana Jack, Black-Mouser 164-6218	4	A GND, D GND, GND (2)
14		PCB Banana Jack, Red-Mouser 164-6219	4	A VDD, D VDD, HP L, HP R

DEMO BOARD ARTWORKS

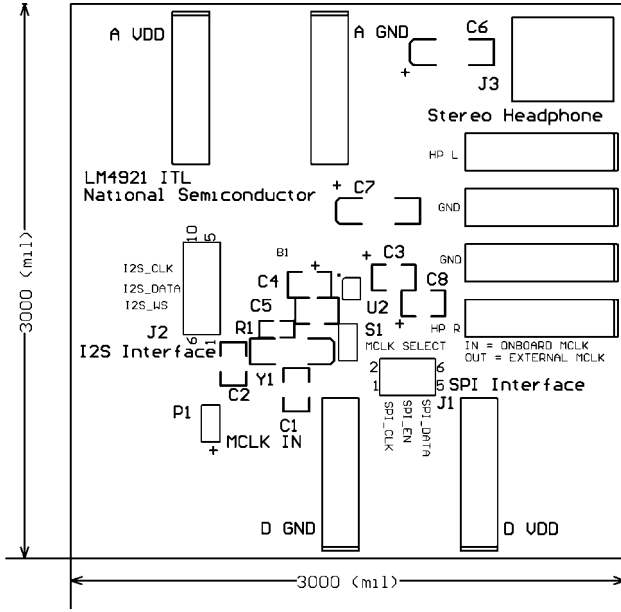

Silkscreen Layer

200486f3

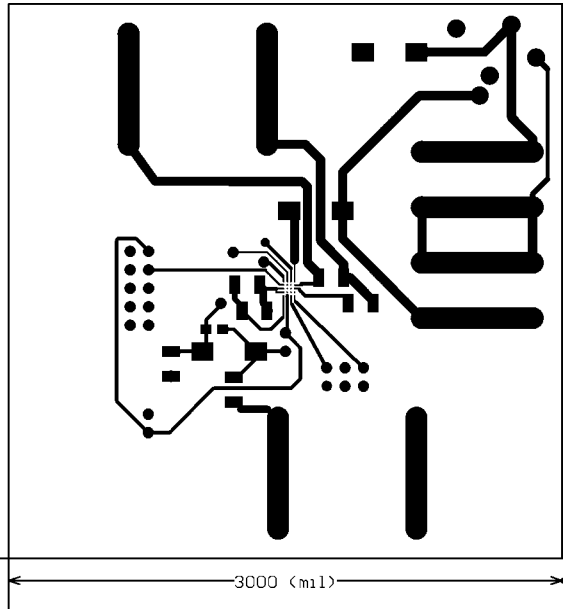

Top Layer

200486f1

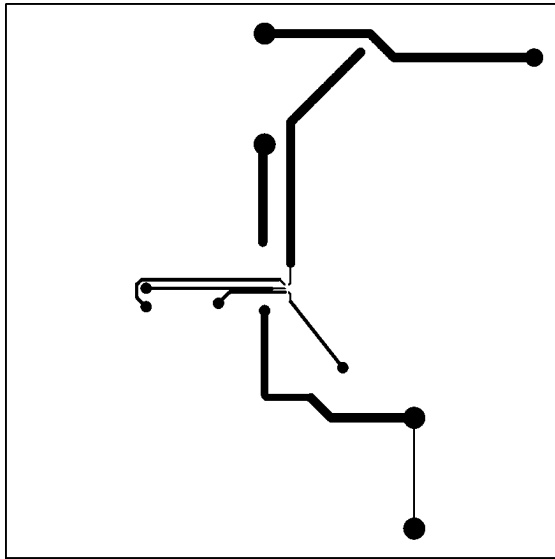

Mid Layer 1

200486f2

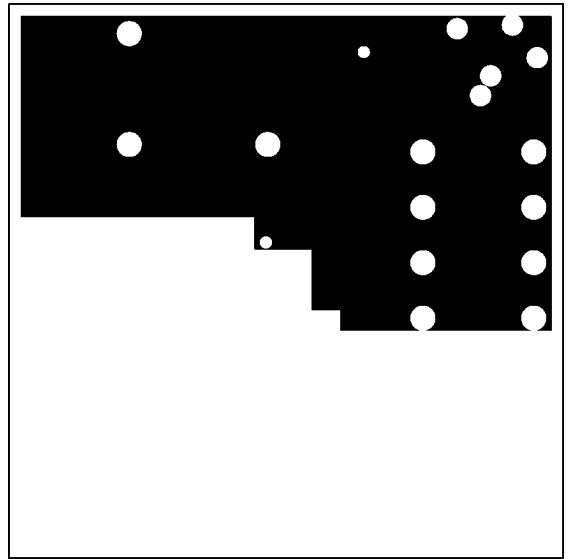

Mid Layer 2

200486h1

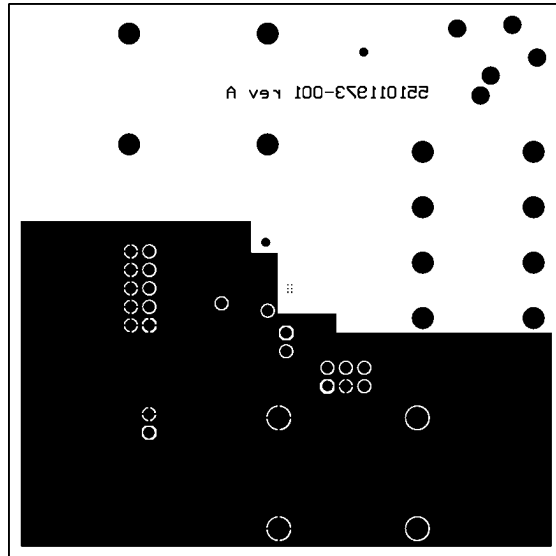

Bottom Layer

200486h0

Physical Dimensions inches (millimeters) unless otherwise noted

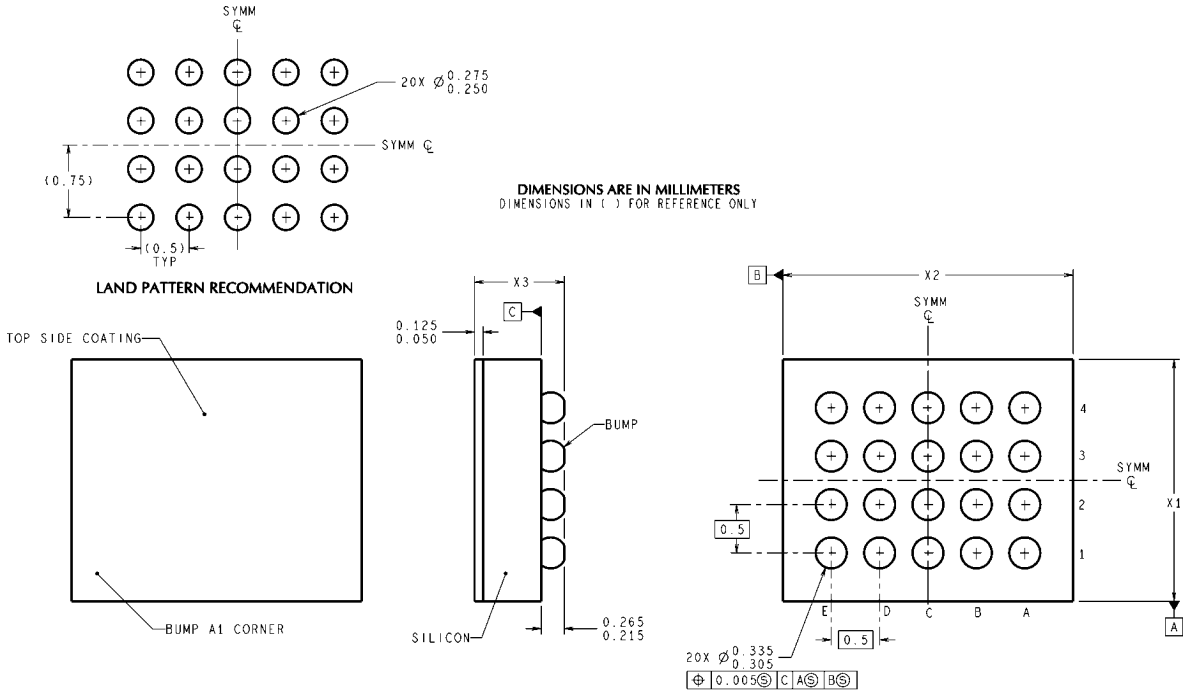

DIMENSIONS ARE IN MILLIMETERS
DIMENSIONS IN () FOR REFERENCE ONLY

TLA20XXX (Rev D)

20 Bump micro SMD
Order Number LM4921ITL, LM4921ITLX
NS Package Number TLA20JKA
X1 = 2.200 ± 0.03mm X2 = 2.720 ± 0.03mm X3 = 0.600 ± 0.075mm

Notes

Notes

THE CONTENTS OF THIS DOCUMENT ARE PROVIDED IN CONNECTION WITH NATIONAL SEMICONDUCTOR CORPORATION ("NATIONAL") PRODUCTS. NATIONAL MAKES NO REPRESENTATIONS OR WARRANTIES WITH RESPECT TO THE ACCURACY OR COMPLETENESS OF THE CONTENTS OF THIS PUBLICATION AND RESERVES THE RIGHT TO MAKE CHANGES TO SPECIFICATIONS AND PRODUCT DESCRIPTIONS AT ANY TIME WITHOUT NOTICE. NO LICENSE, WHETHER EXPRESS, IMPLIED, ARISING BY ESTOPPEL OR OTHERWISE, TO ANY INTELLECTUAL PROPERTY RIGHTS IS GRANTED BY THIS DOCUMENT.

TESTING AND OTHER QUALITY CONTROLS ARE USED TO THE EXTENT NATIONAL DEEMS NECESSARY TO SUPPORT NATIONAL'S PRODUCT WARRANTY. EXCEPT WHERE MANDATED BY GOVERNMENT REQUIREMENTS, TESTING OF ALL PARAMETERS OF EACH PRODUCT IS NOT NECESSARILY PERFORMED. NATIONAL ASSUMES NO LIABILITY FOR APPLICATIONS ASSISTANCE OR BUYER PRODUCT DESIGN. BUYERS ARE RESPONSIBLE FOR THEIR PRODUCTS AND APPLICATIONS USING NATIONAL COMPONENTS. PRIOR TO USING OR DISTRIBUTING ANY PRODUCTS THAT INCLUDE NATIONAL COMPONENTS, BUYERS SHOULD PROVIDE ADEQUATE DESIGN, TESTING AND OPERATING SAFEGUARDS.

EXCEPT AS PROVIDED IN NATIONAL'S TERMS AND CONDITIONS OF SALE FOR SUCH PRODUCTS, NATIONAL ASSUMES NO LIABILITY WHATSOEVER, AND NATIONAL DISCLAIMS ANY EXPRESS OR IMPLIED WARRANTY RELATING TO THE SALE AND/OR USE OF NATIONAL PRODUCTS INCLUDING LIABILITY OR WARRANTIES RELATING TO FITNESS FOR A PARTICULAR PURPOSE, MERCHANTABILITY, OR INFRINGEMENT OF ANY PATENT, COPYRIGHT OR OTHER INTELLECTUAL PROPERTY RIGHT.

LIFE SUPPORT POLICY

NATIONAL'S PRODUCTS ARE NOT AUTHORIZED FOR USE AS CRITICAL COMPONENTS IN LIFE SUPPORT DEVICES OR SYSTEMS WITHOUT THE EXPRESS PRIOR WRITTEN APPROVAL OF THE CHIEF EXECUTIVE OFFICER AND GENERAL COUNSEL OF NATIONAL SEMICONDUCTOR CORPORATION. As used herein:

Life support devices or systems are devices which (a) are intended for surgical implant into the body, or (b) support or sustain life and whose failure to perform when properly used in accordance with instructions for use provided in the labeling can be reasonably expected to result in a significant injury to the user. A critical component is any component in a life support device or system whose failure to perform can be reasonably expected to cause the failure of the life support device or system or to affect its safety or effectiveness.

National Semiconductor and the National Semiconductor logo are registered trademarks of National Semiconductor Corporation. All other brand or product names may be trademarks or registered trademarks of their respective holders.

Copyright© 2007 National Semiconductor Corporation

For the most current product information visit us at www.national.com



National Semiconductor Americas Customer Support Center
 Email: new.feedback@nsc.com
 Tel: 1-800-272-9959

National Semiconductor Europe Customer Support Center
 Fax: +49 (0) 180-530-85-86
 Email: europe.support@nsc.com
 Deutsch Tel: +49 (0) 69 9508 6208
 English Tel: +49 (0) 870 24 0 2171
 Français Tel: +33 (0) 1 41 91 8790

National Semiconductor Asia Pacific Customer Support Center
 Email: ap.support@nsc.com

National Semiconductor Japan Customer Support Center
 Fax: 81-3-5639-7507
 Email: jpn.feedback@nsc.com
 Tel: 81-3-5639-7560

IMPORTANT NOTICE

Texas Instruments Incorporated and its subsidiaries (TI) reserve the right to make corrections, modifications, enhancements, improvements, and other changes to its products and services at any time and to discontinue any product or service without notice. Customers should obtain the latest relevant information before placing orders and should verify that such information is current and complete. All products are sold subject to TI's terms and conditions of sale supplied at the time of order acknowledgment.

TI warrants performance of its hardware products to the specifications applicable at the time of sale in accordance with TI's standard warranty. Testing and other quality control techniques are used to the extent TI deems necessary to support this warranty. Except where mandated by government requirements, testing of all parameters of each product is not necessarily performed.

TI assumes no liability for applications assistance or customer product design. Customers are responsible for their products and applications using TI components. To minimize the risks associated with customer products and applications, customers should provide adequate design and operating safeguards.

TI does not warrant or represent that any license, either express or implied, is granted under any TI patent right, copyright, mask work right, or other TI intellectual property right relating to any combination, machine, or process in which TI products or services are used. Information published by TI regarding third-party products or services does not constitute a license from TI to use such products or services or a warranty or endorsement thereof. Use of such information may require a license from a third party under the patents or other intellectual property of the third party, or a license from TI under the patents or other intellectual property of TI.

Reproduction of TI information in TI data books or data sheets is permissible only if reproduction is without alteration and is accompanied by all associated warranties, conditions, limitations, and notices. Reproduction of this information with alteration is an unfair and deceptive business practice. TI is not responsible or liable for such altered documentation. Information of third parties may be subject to additional restrictions.

Resale of TI products or services with statements different from or beyond the parameters stated by TI for that product or service voids all express and any implied warranties for the associated TI product or service and is an unfair and deceptive business practice. TI is not responsible or liable for any such statements.

TI products are not authorized for use in safety-critical applications (such as life support) where a failure of the TI product would reasonably be expected to cause severe personal injury or death, unless officers of the parties have executed an agreement specifically governing such use. Buyers represent that they have all necessary expertise in the safety and regulatory ramifications of their applications, and acknowledge and agree that they are solely responsible for all legal, regulatory and safety-related requirements concerning their products and any use of TI products in such safety-critical applications, notwithstanding any applications-related information or support that may be provided by TI. Further, Buyers must fully indemnify TI and its representatives against any damages arising out of the use of TI products in such safety-critical applications.

TI products are neither designed nor intended for use in military/aerospace applications or environments unless the TI products are specifically designated by TI as military-grade or "enhanced plastic." Only products designated by TI as military-grade meet military specifications. Buyers acknowledge and agree that any such use of TI products which TI has not designated as military-grade is solely at the Buyer's risk, and that they are solely responsible for compliance with all legal and regulatory requirements in connection with such use.

TI products are neither designed nor intended for use in automotive applications or environments unless the specific TI products are designated by TI as compliant with ISO/TS 16949 requirements. Buyers acknowledge and agree that, if they use any non-designated products in automotive applications, TI will not be responsible for any failure to meet such requirements.

Following are URLs where you can obtain information on other Texas Instruments products and application solutions:

Products

Audio	www.ti.com/audio
Amplifiers	amplifier.ti.com
Data Converters	dataconverter.ti.com
DLP® Products	www.dlp.com
DSP	dsp.ti.com
Clocks and Timers	www.ti.com/clocks
Interface	interface.ti.com
Logic	logic.ti.com
Power Mgmt	power.ti.com
Microcontrollers	microcontroller.ti.com
RFID	www.ti-rfid.com
OMAP Mobile Processors	www.ti.com/omap
Wireless Connectivity	www.ti.com/wirelessconnectivity

Applications

Communications and Telecom	www.ti.com/communications
Computers and Peripherals	www.ti.com/computers
Consumer Electronics	www.ti.com/consumer-apps
Energy and Lighting	www.ti.com/energy
Industrial	www.ti.com/industrial
Medical	www.ti.com/medical
Security	www.ti.com/security
Space, Avionics and Defense	www.ti.com/space-avionics-defense
Transportation and Automotive	www.ti.com/automotive
Video and Imaging	www.ti.com/video

TI E2E Community Home Page

e2e.ti.com

Mailing Address: Texas Instruments, Post Office Box 655303, Dallas, Texas 75265
Copyright © 2011, Texas Instruments Incorporated

www.BDTIC.com/TI