

## 1.5A Buck/Boost/Inverting DC-DC Switching Regulator

### FEATURES

- Supply Voltage: 3V - 36V
- Current Limiting
- Output Switch Current to 1.5A
- Adjustable Output Voltage
- Operation frequency up to 110KHz
- Low Quiescent Current
- Precision 2% Reference
- Available in 8 pin NSOIC Package

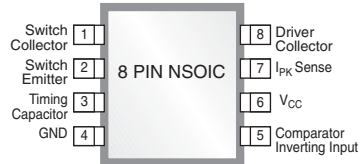

*Now Available in Lead Free Packaging*

### APPLICATIONS

- Battery Charger Circuit
- NICs/Switches/Hubs
- ADSL Modems
- Negative Voltage Power Supply

### DESCRIPTION

The SP34063A is a monolithic switching regulator control circuit containing the primary functions required for DC-DC converters. This device consists of an internal temperature compensated reference, voltage comparator, controlled duty cycle oscillator with active current limit circuit, driver and high current output switch. This device was specifically designed to be used in buck, boost, and Voltage-Inverting applications with a minimum number of external components. The SP34063A is available in the 8 pin NSOIC package.

### TYPICAL APPLICATION CIRCUIT

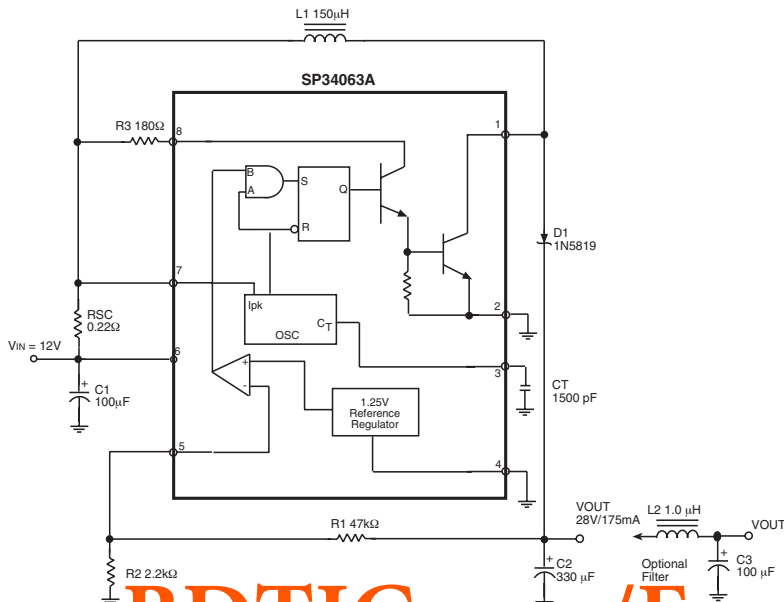

## ABSOLUTE MAXIMUM RATINGS

These are stress ratings only and functional operation of the device at these ratings or any other above those indicated in the operation sections of the specifications below is not implied. Exposure to absolute maximum rating conditions for extended periods of time may affect reliability.

Parameter	Symbol	Value	Unit
Power Supply Voltage	$V_{CC}$	40	V
Comparator Input Voltage Range	$V_{IR}$	-0.3 to 40	V
Switch Collector Voltage	$V_C(\text{switch})$	40	V
Switch Emitter Voltage ( $V_{pin1}=40V$ )	$V_E(\text{switch})$	40	V
Switch Collector to Emitter Voltage	$V_{CE}(\text{switch})$	40	V
Driver Collector Voltage	$V_C(\text{driver})$	40	V
Driver Collector Current (Note 2)	$I_C(\text{driver})$	100	mA
Switch Current	$I_{SW}$	1.5	A
Power Dissipation and Thermal Characteristics for NSOIC Package			
Power Dissipation ( $T_A = 25^\circ\text{C}$ )	$P_D$	625	mW
Thermal Resistance	$R_{\theta JA}$	160	$^\circ\text{C}/\text{W}$
Operating Junction Temperature	$T_J$	150	$^\circ\text{C}$
Storage Temperature Range	$T_{STG}$	-65 to 150	$^\circ\text{C}$
ESD (Human Body Model)	-	2000	V

## ELECTRICAL CHARACTERISTICS

Unless otherwise noted, the following specifications apply for  $V_{CC} = +5.0V$ ,  $T_A = -40$  to  $85^\circ C$ .

PARAMETER	SYMBOL	MIN.	TYP.	MAX.	UNITS	CONDITIONS
<b>Oscillator</b>						
Frequency	$F_{OSC}$	30	38	45	KHz	VPin 5 = 0V, CT = 1.0nF $T_A = 25^\circ C$
Charge Current	$I_{CHG}$	30	38	45	$\mu A$	$V_{CC} = 5.0V$ to 36V, $T_A = 25^\circ C$
Discharge Current	$I_{DISCHG}$	180	240	290	$\mu A$	$V_{CC} = 5.0V$ to 36V, $T_A = 25^\circ C$
Discharge to Charge Current Ratio	$I_{DISCHG}/I_{CHG}$	5.2	6.5	7.5		Pin 7 to $V_{CC}$ , $T_A = 25^\circ C$
Current Limit Sense Voltage	$V_{IPK(sense)}$	250	300	350	mV	$I_{CHG} = I_{DISCHG}$ , $T_A = 25^\circ C$
<b>Output Switch (note 1)</b>						
Saturation Voltage, Darlington Connection VCE(sat)	$V_{CE(SAT)}$	-	1.0	1.3	V	$I_{SW} = 1.0A$ , Pins 1, 8 connected
Saturation Voltage (note 2)	$V_{CE(SAT)}$	-	0.45	0.7	V	$I_{SW} = 1.0A$ , RPin 8 = 82 $\Omega$ to $V_{CC}$ , Forced $\beta = 20$
DC Current Gain	$h_{FE}$	50	75	-		$I_{SW} = 1.0A$ , $V_{CE} = 5.0V$ , $T_A = 25^\circ C$
Collector Off-State Current	$I_C(off)$	-	0.01	100	$\mu A$	$V_{CE} = 36V$
<b>Comparator</b>						
Threshold Voltage	$V_{TH}$	1.225	1.250	1.275	V	$T_A = 25^\circ C$
		1.21	1.250	1.29		$T_A = -40^\circ C$ to $85^\circ C$
Threshold Voltage Line Regulation	$R_{EGLINE}$		1.4	5	mV	$V_{CC} = 3.0V$ to 36V
Input Bias Current	$I_{IB}$		-20	-400	nA	$V_{IN} = 0V$
<b>Total Device</b>						
Supply Current	$I_{CC}$			4	mA	$V_{CC} = 5.0V$ to 36V, CT = 1.0nF, Pin 7 = $V_{CC}$ , VPin 5 > $V_{TH}$

Note 1: Low duty cycle pulse techniques are used during the test program to maintain junction temperature as close to ambient temperature as possible.

Note 2: If the output switch is driven into hard saturation (non-Darlington configuration) at low switch currents ( $\leq 300mA$ ) and high driver currents ( $\geq 30mA$ ), it may take up to 2.0 $\mu s$  for it to come out of saturation. This condition will shorten the off time at frequencies above 30KHz, and is magnified at high temperatures. This condition does not occur with a Darlington configuration, since the output switch cannot saturate. If a non-Darlington configuration is used, the following output drive condition is recommended.

$$\text{Forced } \beta \text{ of output switch: } \frac{I_C \text{ Output}}{I_C \text{ driver} - 7.0mA^*} \geq 10$$

\*The 100 $\Omega$  resistor in the emitter of the driver device requires about 7.0 mA before the output switch conducts.

www.BDTIC.com/Exar/

## PIN DESCRIPTION

Pin Number	Pin Name	Description
1	Switching Collector	Internal switch transistor collector.
2	Switching Emitter	Internal switch transistor emitter.
3	Timing Capacitor	Timing capacitor to control the switching frequency.
4	GND	Ground pin for all internal circuit.
5	Comparator Inverting Input	Inverting input pin for internal comparator.
6	V <sub>CC</sub>	Voltage supply
7	I <sub>PK</sub> Sense	Peak Current Sense Input by monitoring the voltage drop across an external I sense resistor to limit the peak current through the switch.
8	Driver Collector	Voltage driver collector

## BLOCK DIAGRAM

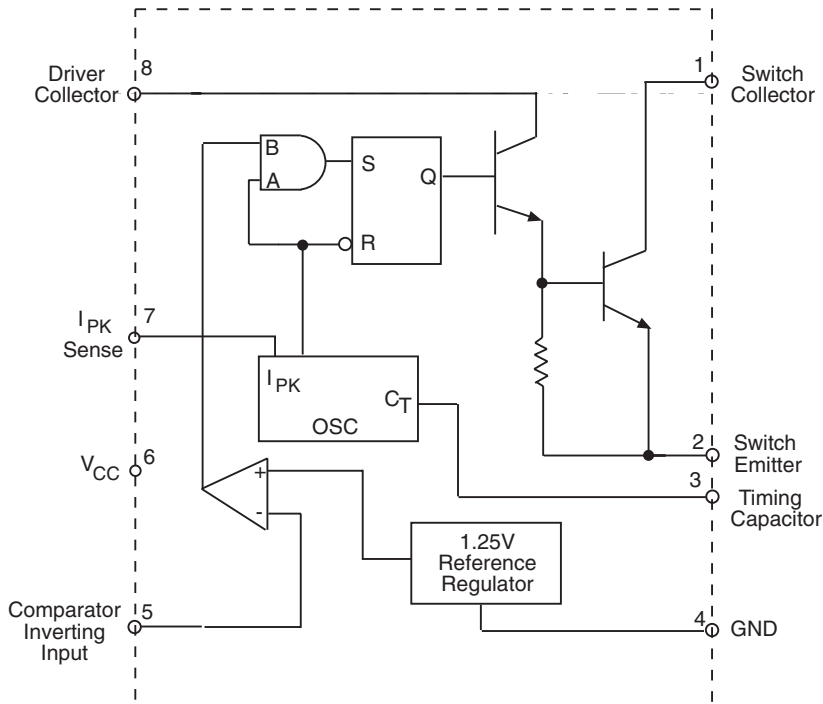

## TYPICAL BOOST CONVERTER CIRCUIT

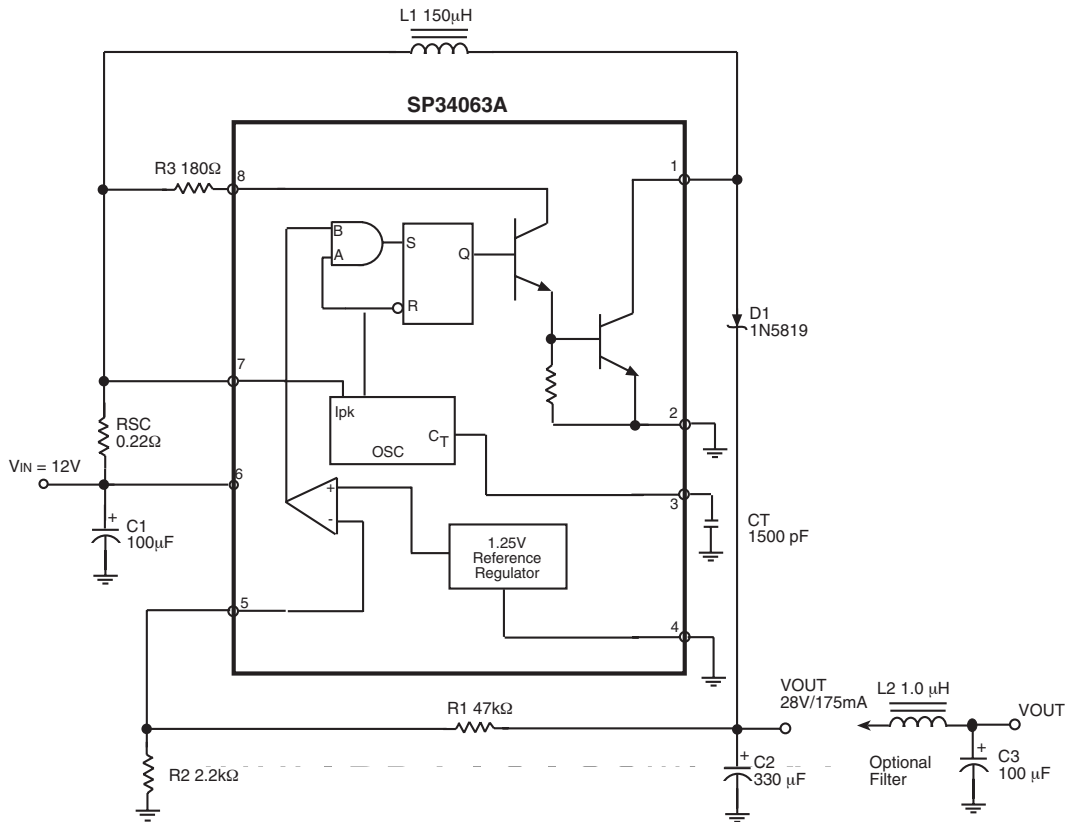

This is a typical boost converter configuration. In the steady state, if the resistor divider voltage at pin 5 is greater than the voltage in the non-inverting input, which is 1.25V determined by the internal reference, the output of the comparator will go low. At the next switching period, the output switch will not conduct and the output voltage will eventually drop below its nominal voltage until the divider voltage at pin 5 is lower than 1.25. Then the output of the comparator will go high, the output switch will be allowed to conduct. Since  $V_{pin5} = V_{OUT} * R2 / (R1 + R2) = 1.25(V)$ , The output voltage can be decided by  $V_{OUT} = 1.25V * (R1 + R2) / R2(V)$ .

## TYPICAL BUCK CONVERTER CIRCUIT

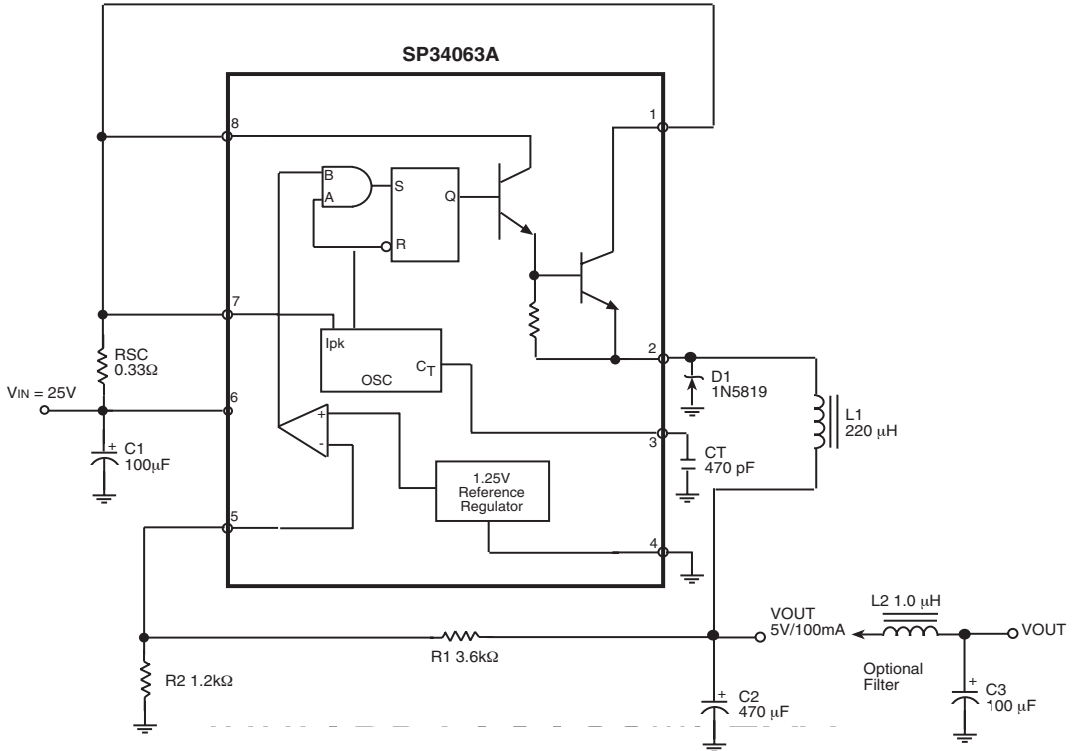

This is a typical buck converter configuration. The working process in the steady state is similar to a boost converter,  $V_{pin5} = V_{OUT} * R2 / (R1 + R2) = 1.25(V)$ . The output voltage can be decided by  $V_{OUT} = 1.25V * (R1 + R2) / R2(V)$ .

## TYPICAL INVERTING CONVERTER CIRCUIT

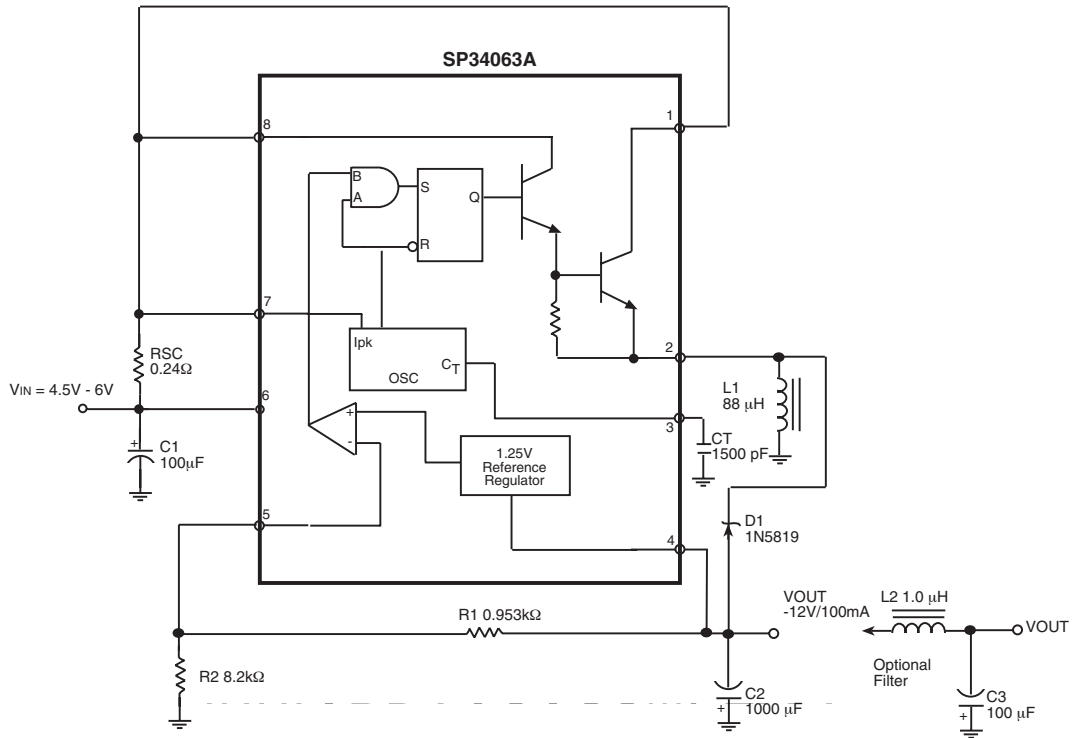

This is a typical boost converter configuration. The working process in the steady state is similar to a boost converter, the difference in this situation is that the voltage at the non-inverting pin of the comparator is equal to  $1.25V + V_{OUT}$ , then  $V_{pin5} = V_{OUT} * R2 / (R1 + R2) = 1.25V + V_{OUT}$ . The output voltage can be decided by  $V_{OUT} = -1.25V * (R1 + R2) / R1$  (V).

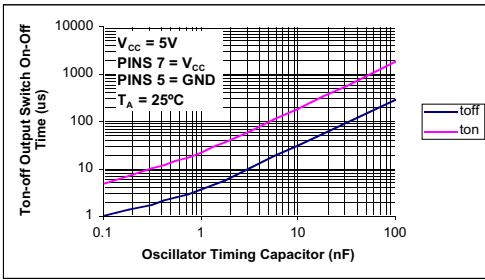

Figure 1. Output Switch On-Off Time vs. Oscillator Timing Capacitor

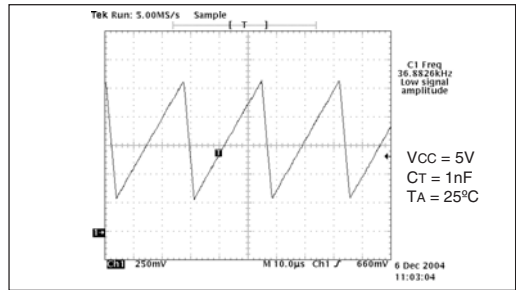

Figure 2. Timing Capacitor Waveform

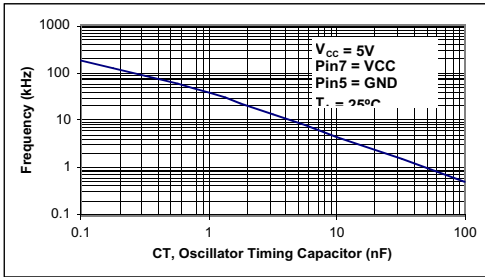

Figure 3. Oscillator Frequency vs. Timing Capacitor

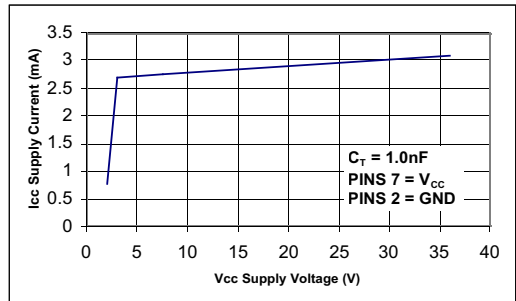

Figure 4. Standard Supply Current vs. Supply Voltage

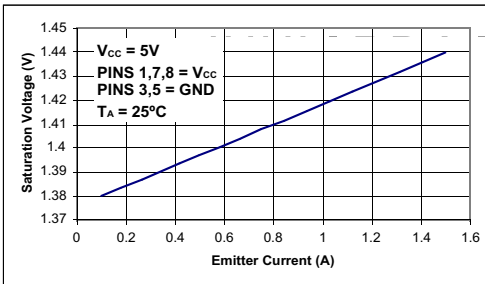

Figure 5. Emitter Follower Configuration Output Switch Saturation vs. Emitter Current

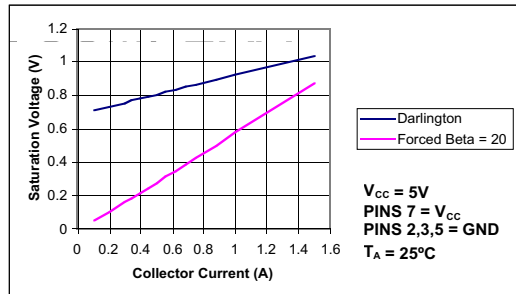

Figure 6. Common Emitter Configuration Output Switch Saturation vs. Collector Current

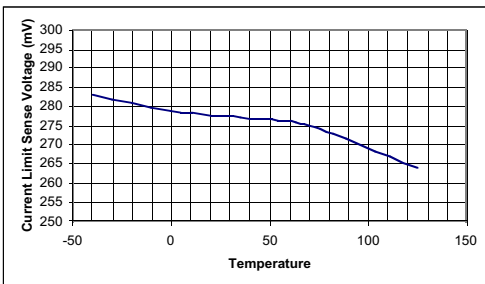
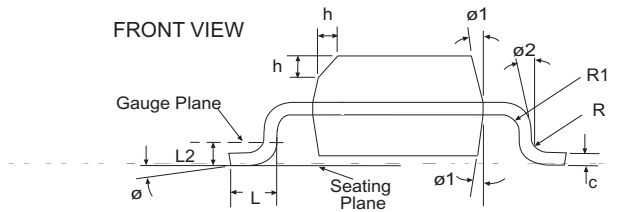
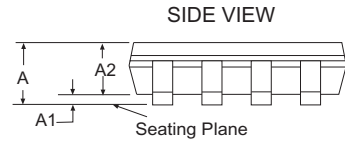
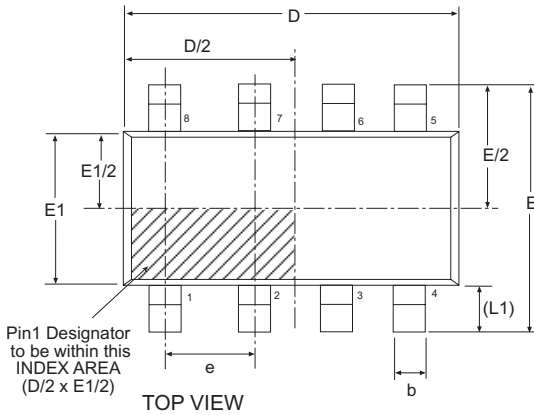

Figure 7. Current Limit Sense Voltage vs. Temperature





8 Pin NSOIC		JEDEC MS-012		Variation AA		
SYMBOL	Dimensions in Millimeters: Controlling Dimension			Dimensions in Inches Conversion Factor: 1 Inch = 25.40 mm		
	MIN	NOM	MAX	MIN	NOM	MAX
A	1.35	-	1.75	0.053	-	0.069
A1	0.10	-	0.25	0.004	-	0.010
A2	1.25	-	1.65	0.049	-	0.065
b	0.31	-	0.51	0.012	-	0.020
c	0.17	-	0.25	0.007	-	0.010
E	6.00 BSC			0.236 BSC		
E1	3.90 BSC			0.154 BSC		
e	1.27 BSC			0.050 BSC		
h	0.25	-	0.50	0.010	-	0.020
L	0.40	-	1.27	0.016	-	0.050
L1	1.04 REF			0.041 REF		
L2	0.25 BSC			0.010 BSC		
R	0.07	-	-	0.003	-	-
R1	0.07	-	-	0.003	-	-
ø	0°	-	8°	0°	-	8°
ø1	5°	-	15°	5°	-	15°
ø2	0°	-	-	0°	-	-
D	4.90 BSC			0.193 BSC		
SIPEX Pkg Signoff Date/Rev:				JL Aug16-05 / Rev A		

## ORDERING INFORMATION

Part Number	Temperature Range	Package Types
SP34063AEN .....	-40°C to +85°C .....	8-pin NSOIC
SP34063AEN/TR .....	-40°C to +85°C .....	8-pin NSOIC

Available in lead free packaging. To order add "-L" suffix to part number.

Example: SP34063AEN/TR = standard; SP34063AEN-L/TR = lead free

/TR = Tape and Reel

Pack quantity is 2,500 for NSOIC.



ANALOG EXCELLENCE

**Sipex Corporation**

**Headquarters and  
Sales Office**  
233 South Hillview Drive  
Milpitas, CA 95035  
TEL: (408) 934-7500  
FAX: (408) 935-7600

Sipex Corporation reserves the right to make changes to any products described herein. Sipex does not assume any liability arising out of the application or use of any product or circuit described herein; neither does it convey any license under its patent rights nor the rights of others.

[www.BDTIC.com/Exar/](http://www.BDTIC.com/Exar/)