

## FAN6755W / FAN6755UW mWSaver™ PWM Controller

### Features

- mWSaver™ Technology Provides Industry's Best-in-Class Standby Power
  - <100 mW at 25-mW Load for LCDM Adaptor
  - Internal High-Voltage JFET Startup
  - Low Operating Current: Under 2 mA
  - Adaptively Decrease PWM Frequency to 23 kHz at Light-Load Condition for Better Efficiency
  - Feedback Impedance Switching During Minimum Load or No Load
- Proprietary Asynchronous Frequency Hopping Technique that Reduces EMI
- Fixed PWM Frequency: 65 kHz (FAN6755W), 130 kHz (FAN6755UW)
- Internal Leading-Edge Blanking
- Built-in Synchronized Slope Compensation
- Auto-Restart Protection: Feedback Open-Loop Protection (OLP), V<sub>DD</sub> Over-Voltage Protection (OVP), Over-Temperature Protection (OTP), and Line Over-Voltage Protection
- Soft Gate Drive with Clamped Output Voltage: 18 V
- V<sub>DD</sub> Under-Voltage Lockout (UVLO)
- Programmable Constant Power Limit (Full AC Input Range)
- Internal OTP Sensor with Hysteresis
- Build-in 5-ms Soft-Start Function
- Input Voltage Sensing (V<sub>IN</sub> Pin) for Brown-In/Out Protection with Hysteresis and Line Over-Voltage Protection

### Applications

General-purpose switched-mode power supplies and flyback power converters, including:

- LCD Monitor Power Supply
- Open-Frame SMPS

### Description

This highly integrated PWM controller provides several features to enhance the performance of flyback converters.

To minimize standby power consumption, a proprietary adaptive green-mode function reduces switching frequency at light-load condition. To avoid acoustic-noise problems, the minimum PWM frequency is set above 23 kHz. This green-mode function enables the power supply to meet international power conservation requirements, such as Energy Star®. With the internal high-voltage startup circuitry, the power loss caused by bleeding resistors is also eliminated. To further reduce power consumption, FAN6755W/UW uses the BiCMOS process, which allows an operating current of only 2 mA. The standby power consumption can be under 100 mW for most of LCD monitor power supply designs.

FAN6755W/UW integrates a frequency-hopping function that reduces EMI emission of a power supply with minimum line filters. The built-in synchronized slope compensation achieves a stable peak-current-mode control and improves noise immunity. The proprietary line compensation ensures constant output power limit over a wide AC input voltage range from 90 V<sub>AC</sub> to 264 V<sub>AC</sub>.

FAN6755W/UW provides many protection functions. The internal feedback open-loop protection circuit protects the power supply from open-feedback-loop condition or output-short condition. It also has line under-voltage protection (brownout protection) and over-voltage protection using an input voltage sensing pin (V<sub>IN</sub>).

FAN6755W/UW is available in a 7-pin SOP package.

ENERGY STAR® is a registered trademark of the U.S. Department of Energy and the U.S. Environmental Protection Agency.

### Ordering Information

Part Number	Operating Temperature Range	Package	PWM Frequency	Packing Method
FAN6755WMY	-40 to +105°C	7-Lead, Small Outline Integrated Circuit (SOIC), Depopulated JEDEC MS-112, .150 Inch Body	65 kHz	Reel & Tape
FAN6755UWMY	-40 to +105°C		130 kHz	Reel & Tape

### Application Diagram

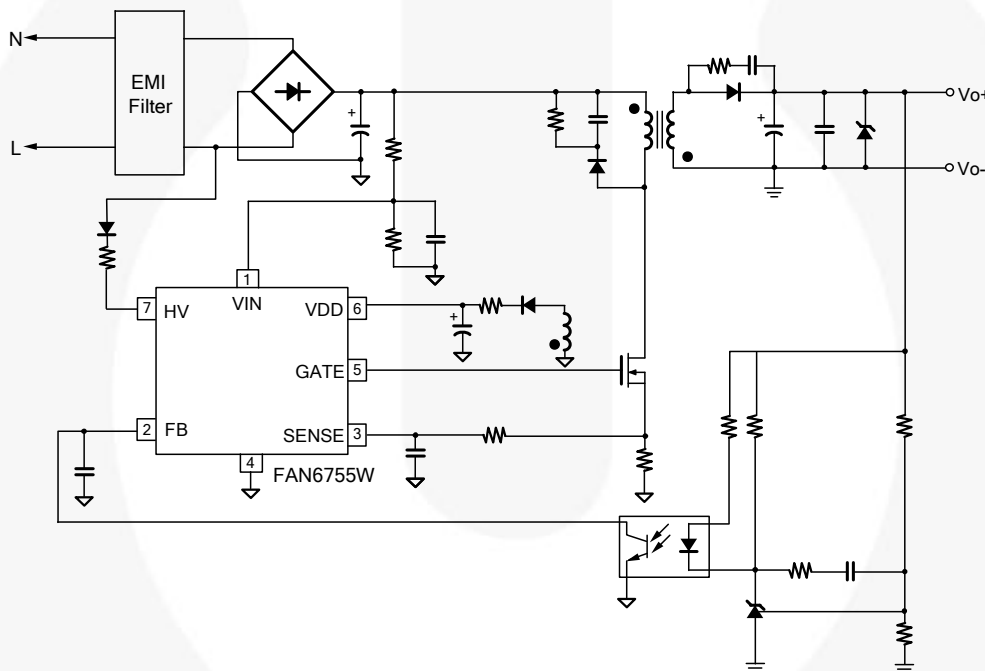

Figure 1. Typical Application

Internal Block Diagram

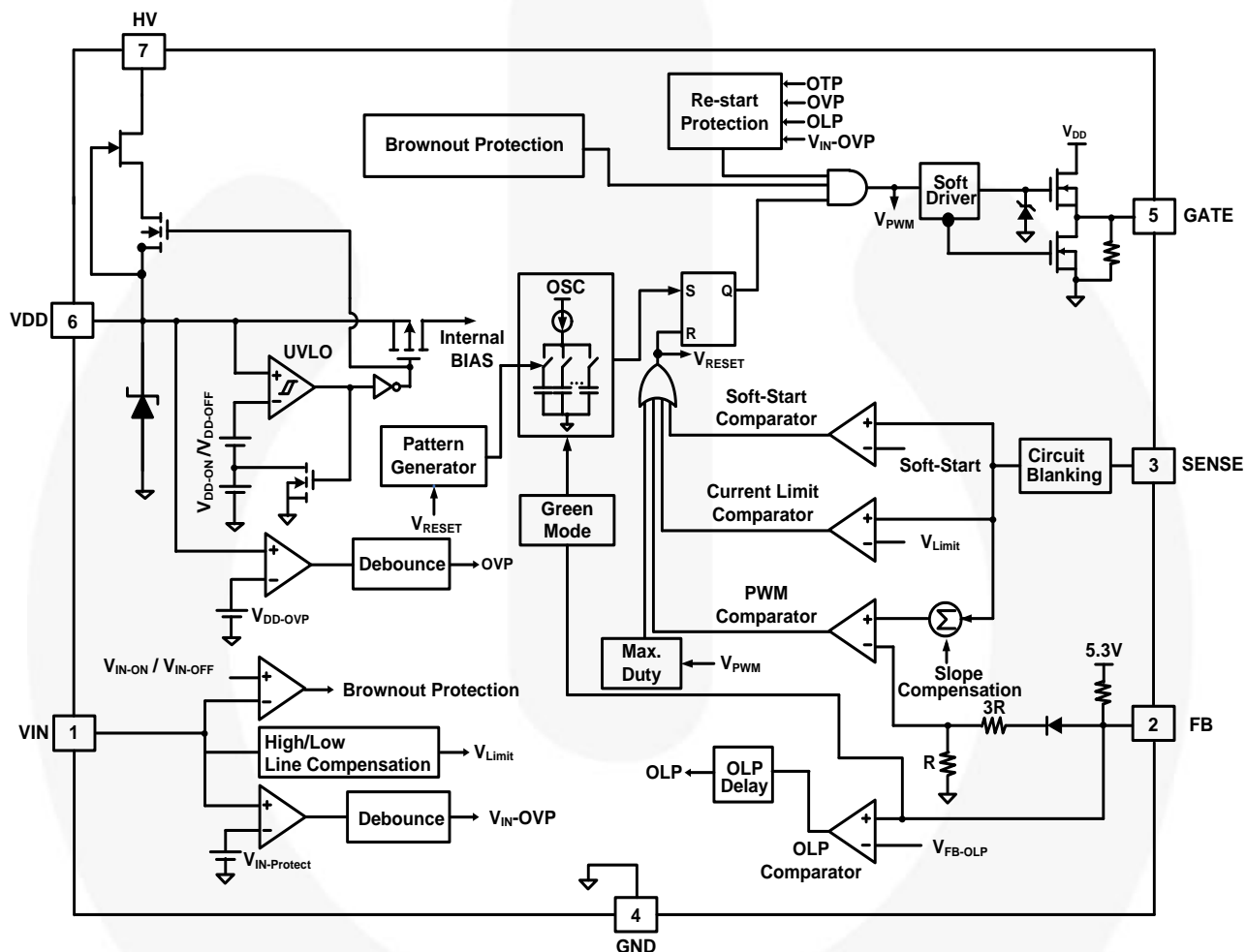
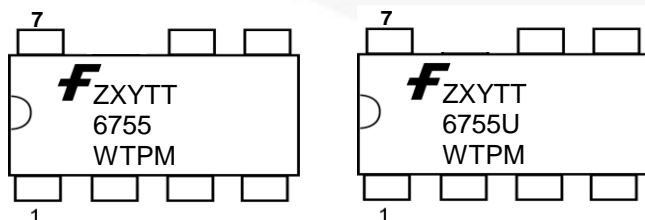

Figure 2. Internal Block Diagram

Marking Information



Z: Plant Code  
 X: 1-Digit Year Code  
 Y: 1-Digit Week Code  
 TT: 2-Digit Die Run Code  
 T: Package Type (M:SOP)  
 P: Y=Green Package  
 M: Manufacture Flow Code

Figure 3. Top Mark

## Pin Configuration

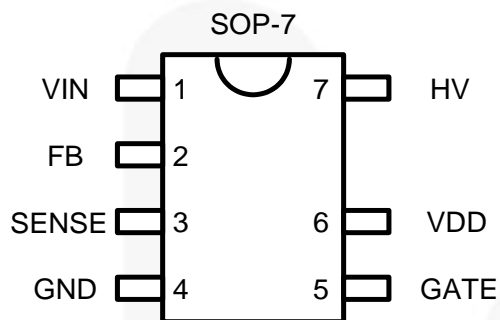

Figure 4. Pin Configuration (Top View)

## Pin Definitions

Pin #	Name	Description
1	VIN	Line-voltage detection. The line-voltage detection is used for brownout protection with hysteresis. Constant output power limit over universal AC input range is also achieved using this VIN pin. It is suggested to add a low-pass filter to filter out line ripple on the bulk capacitor. Pulling VIN HIGH also triggers auto-restart protection.
2	FB	The signal from the external compensation circuit is fed into this pin. The PWM duty cycle is determined in response to the signal on this pin and the current-sense signal on the SENSE pin.
3	SENSE	Current sense. The sensed voltage is used for peak-current-mode control and cycle-by-cycle current limiting.
4	GND	Ground
5	GATE	The totem-pole output driver. Soft-driving waveform is implemented for improved EMI.
6	VDD	Power supply. The internal protection circuit disables PWM output as long as $V_{DD}$ exceeds the OVP trigger point.
7	HV	For startup, this pin is connected to the line input or bulk capacitor in series with resistors.



## Absolute Maximum Ratings

Stresses exceeding the absolute maximum ratings may damage the device. The device may not function or be operable above the recommended operating conditions and stressing the parts to these levels is not recommended. In addition, extended exposure to stresses above the recommended operating conditions may affect device reliability. The absolute maximum ratings are stress ratings only.

Symbol	Parameter		Min.	Max.	Unit
V <sub>VDD</sub>	DC Supply Voltage <sup>(1, 2)</sup>			30	V
V <sub>FB</sub>	FB Pin Input Voltage		-0.3	7.0	V
V <sub>SENSE</sub>	SENSE Pin Input Voltage		-0.3	7.0	V
V <sub>VIN</sub>	VIN Pin Input Voltage		-0.3	7.0	V
V <sub>HV</sub>	HV Pin Input Voltage			700	V
P <sub>D</sub>	Power Dissipation (T <sub>A</sub> < 50°C)			400	mW
Θ <sub>JA</sub>	Thermal Resistance (Junction-to-Air)			150	°C/W
T <sub>J</sub>	Operating Junction Temperature		-40	+125	°C
T <sub>STG</sub>	Storage Temperature Range		-55	+150	°C
T <sub>L</sub>	Lead Temperature (Wave Soldering or IR, 10 Seconds)			+260	°C
ESD	Human Body Model, JEDEC: JESD22-A114	All Pins Except HV Pin		5.5	kV
	Charged Device Model, JEDEC: JESD22-C101	All Pins Except HV Pin		2.0	

### Notes:

- All voltage values, except differential voltages, are given with respect to the network ground terminal.
- Stresses beyond those listed under Absolute Maximum Ratings may cause permanent damage to the device.
- ESD with HV pin: CDM=2000 V (FAN6755W) or 1500 V (FAN6755UW), and HBM=3500 V.



## Electrical Characteristics

$V_{DD}=15\text{ V}$ ,  $T_A=25^\circ\text{C}$ , unless otherwise noted.

Symbol	Parameter	Conditions	Min.	Typ.	Max.	Unit
<b>V<sub>DD</sub> Section</b>						
$V_{OP}$	Continuously Operating Voltage	Full Load			22	V
$V_{DD-ON}$	Start Threshold Voltage		15	16	17	V
$V_{DD-OFF}$	Protection Mode		9	10	11	V
UVLO	Normal Mode		6.8	7.8	8.8	V
$I_{DD-ST}$	Startup Current	$V_{DD-ON} - 0.16\text{ V}$			30	$\mu\text{A}$
$I_{DD-OP}$	Operating Supply Current	$V_{DD}=15\text{ V}$ , GATE Open			2	mA
$I_{DD-OLP}$	Internal Sink Current	$V_{DD-OLP}+0.1\text{ V}$	30	60	90	$\mu\text{A}$
$V_{DD-OLP}$	Threshold Voltage on $V_{DD}$ for HV JFET Turn-On		6.5	7.5	8.0	V
$V_{DD-OVP}$	$V_{DD}$ Over-Voltage Protection		25	26	27	V
$t_{D-VDDOVP}$	$V_{DD}$ Over-Voltage Protection Debounce Time		75	125	200	$\mu\text{s}$
<b>HV Section</b>						
$I_{HV}$	Supply Current Drawn from HV Pin	$V_{DC}=120\text{ V}$ , $V_{DD}=10\ \mu\text{F}$ , $V_{DD}=0\text{ V}$	2.0	3.5	5.0	mA
$I_{HV-LC}$	Leakage Current after Startup	HV=700 V, $V_{DD}=V_{DD-OFF}+1\text{ V}$		1	20	$\mu\text{A}$

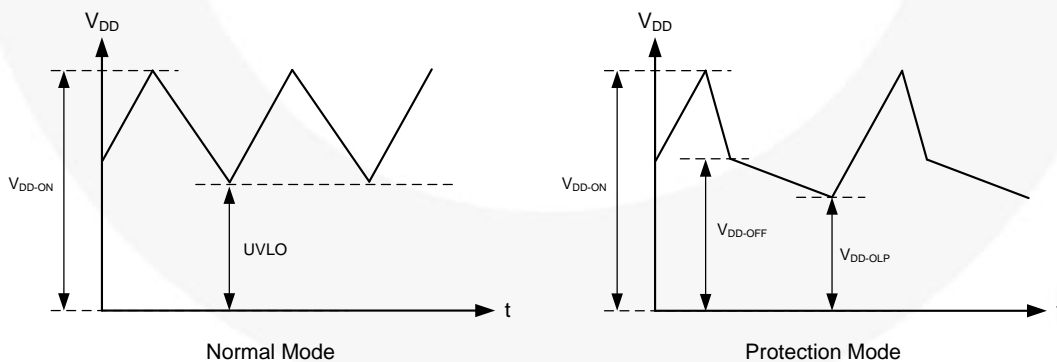

Figure 5.  $V_{DD}$  Behavior

Continued on the following page...

## Electrical Characteristics

$V_{DD}=15\text{ V}$ ,  $T_A=25^\circ\text{C}$ , unless otherwise noted.

Symbol	Parameter	Conditions	Min.	Typ.	Max.	Unit	
<b>Oscillator Section</b>							
$f_{OSC}$	Frequency in Normal Mode	Center Frequency	FAN6755W	62	65	68	kHz
			FAN6755UW	124	130	136	
		Hopping Range	FAN6755W	$\pm 4.5$	$\pm 5.2$	$\pm 5.9$	
			FAN6755UW	$\pm 9$	$\pm 10.4$	$\pm 11.8$	
$f_{OSC-G}$	Green-Mode Frequency		20	23	26	kHz	
$t_{HOP}$	Hopping Period		10	12	14	ms	
$f_{DV}$	Frequency Variation vs. $V_{DD}$ Deviation	$V_{DD}=11\text{ V to }22\text{ V}$			5	%	
$f_{DT}$	Frequency Variation vs. Temperature Deviation	$T_A=-40\text{ to }85^\circ\text{C}=T_J$			5	%	
<b><math>V_{IN}</math> Section</b>							
$V_{IN-OFF}$	PWM Turn-Off (Brown-out) Threshold Voltage		0.66	0.70	0.74	V	
$V_{IN-ON}$	PWM Turn-On (Brown in) Threshold Voltage		$V_{IN-OFF}+0.17$	$V_{IN-OFF}+0.20$	$V_{IN-OFF}+0.23$	V	
$V_{IN-Protect}$	Threshold Voltage of $V_{IN}$ Over-Voltage Protection		5.1	5.3	5.5	V	
$t_{VIN-Protect}$	Debounce Time of $V_{IN}$ Over-Voltage Protection		60	100	140	$\mu\text{s}$	
<b>Current-Sense Section</b>							
$V_{LIMIT}$ at $V_{IN}=1\text{ V}$	Threshold Voltage for Current Limit	$V_{IN}=1\text{ V}$	0.80	0.83	0.86	V	
$V_{LIMIT}$ at $V_{IN}=3\text{ V}$	Threshold Voltage for Current Limit	$V_{IN}=3\text{ V}$	0.67	0.70	0.73	V	
$t_{PD}$	Delay to Output			100	200	ns	
$t_{LEB}$	Leading-Edge Blanking Time	Soft-Start (FAN6755UW)	125	150	175	ns	
		Steady State	240	290	340		
$t_{SS}$	Period During Soft-Start Time	Startup Time	4.0	5.5	7.0	ms	

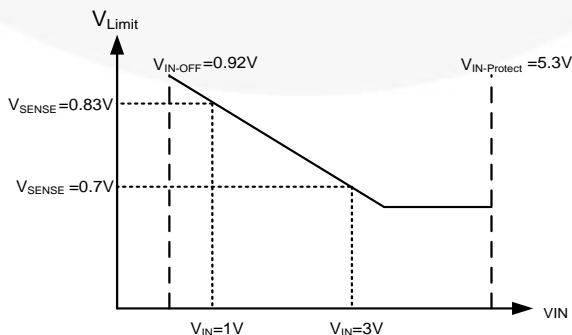

Figure 6.  $V_{IN}$  vs.  $V_{SENSE}$

Continued on the following page...

## Electrical Characteristics

$V_{DD}=15\text{ V}$ ,  $T_A=25^\circ\text{C}$ , unless otherwise noted.

Symbol	Parameter	Conditions	Min.	Typ.	Max.	Unit
<b>Feedback Input Section</b>						
$A_V$	Internal FB Voltage Attenuation		1/4.5	1/4.0	1/3.5	V/V
$Z_{FB}$	Input Impedance	$V_{FB}=4\text{ V}$	10	15	19	k $\Omega$
$V_{FB-OPEN}$	The Maximum Clamp of FB Voltage	FB Pin Open	5.1	5.3	5.5	V
$V_{FB-OLP}$	FB Open-Loop Protection Triggering Level		4.4	4.6	4.8	V
$t_{D-OLP}$	Delay Time of FB Pin Open-loop Protection		45.0	62.5	70.0	ms
$V_{FB-N}$	Green-Mode Entry FB Voltage		2.8	3.0	3.2	V
$V_{FB-G}$	Green-Mode Ending FB Voltage			$V_{FB-N} - 0.6$		V
$V_{FB-ZDCR}$	FB Threshold Voltage for Zero-Duty Recovery		1.6	1.8	2.0	V
$V_{FB-ZDC}$	FB Threshold Voltage for Zero-Duty		1.4	1.6	1.8	V
$V_{FB-ZDCR} - V_{FB-ZDC}$	ZDC Hysteresis		0.12	0.15	0.19	V

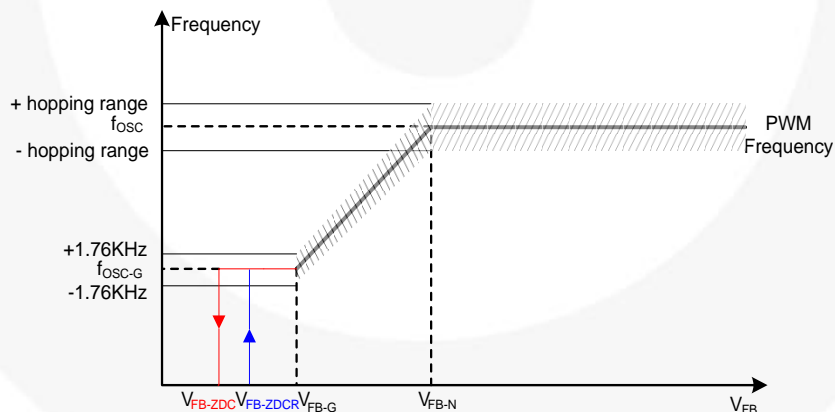

**Figure 7.  $V_{FB}$  vs. PWM Frequency**

*Continued on the following page...*



## Electrical Characteristics

$V_{DD}=15\text{ V}$ ,  $T_A=25^\circ\text{C}$ , unless otherwise noted.

Symbol	Parameter	Conditions	Min.	Typ.	Max.	Unit
<b>GATE Section</b>						
$DCY_{MAX}$	Maximum Duty Cycle		60	75	90	%
$V_{GATE-L}$	Gate Low Voltage	$V_{DD}=15\text{ V}$ , $I_O=50\text{ mA}$			1.5	V
$V_{GATE-H}$	Gate High Voltage	$V_{DD}=12\text{ V}$ , $I_O=50\text{ mA}$	8			V
$t_r$	Gate Rising Time	$V_{DD}=15\text{ V}$ , $C_L=1\text{ nF}$		100		ns
$t_f$	Gate Falling Time	$V_{DD}=15\text{ V}$ , $C_L=1\text{ nF}$		30		ns
$I_{GATE-SOURCE}$	Gate Source Current	$V_{DD}=15\text{ V}$ , $GATE=6\text{ V}$		700		mA
$V_{GATE-CLAMP}$	Gate Output Clamping Voltage	$V_{DD}=22\text{ V}$			18	V
<b>Over-Temperature Protection Section (OTP)</b>						
$T_{OTP}$	Protection Junction Temperature <sup>(4,6)</sup>			140		$^\circ\text{C}$
$T_{Restart}$	Restart Junction Temperature <sup>(5,6)</sup>			$T_{OTP}-25$		$^\circ\text{C}$

### Notes:

- When OTP is activated, the PWM switching is shut down.
- When junction temperature is lower than this level, IC resumes PWM switching.
- These parameters are guaranteed by design.



Typical Performance Characteristics

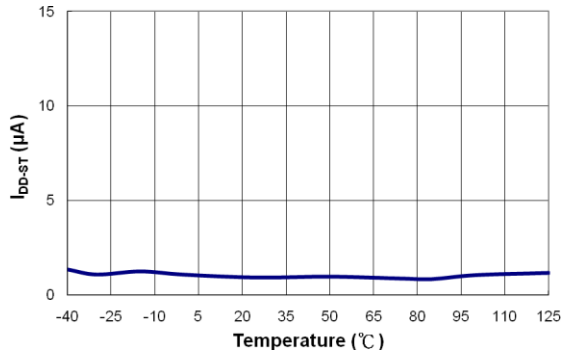

Figure 8. Startup Current ( $I_{DD-ST}$ ) vs. Temperature

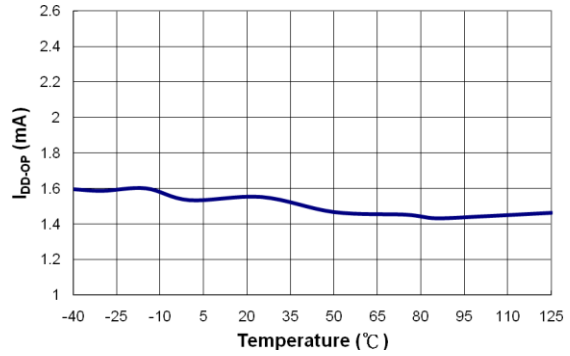

Figure 9. Operation Supply Current ( $I_{DD-OP}$ ) vs. Temperature

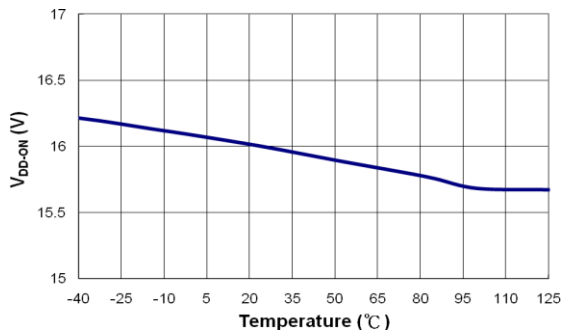

Figure 10. Start Threshold Voltage ( $V_{DD-ON}$ ) vs. Temperature

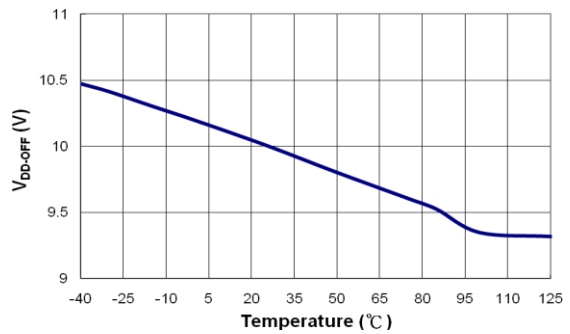

Figure 11. Minimum Operating Voltage ( $V_{DD-OFF}$ ) vs. Temperature

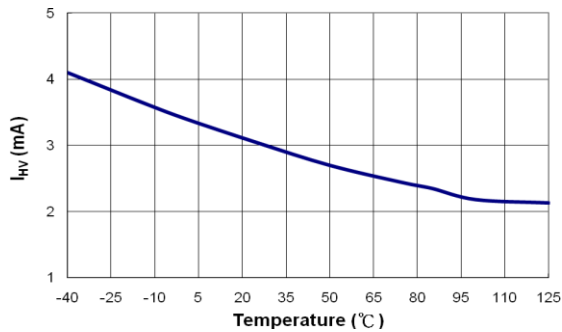

Figure 12. Supply Current Drawn from HV Pin ( $I_{HV}$ ) vs. Temperature

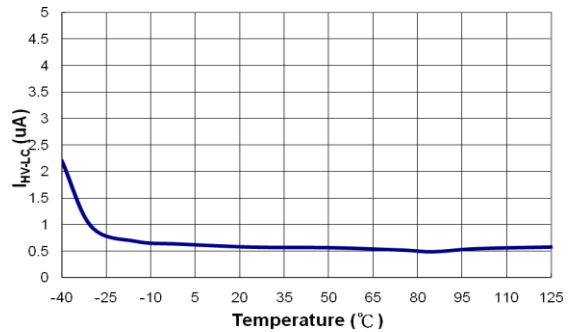

Figure 13. HV Pin Leakage Current After Startup ( $I_{HV-LC}$ ) vs. Temperature

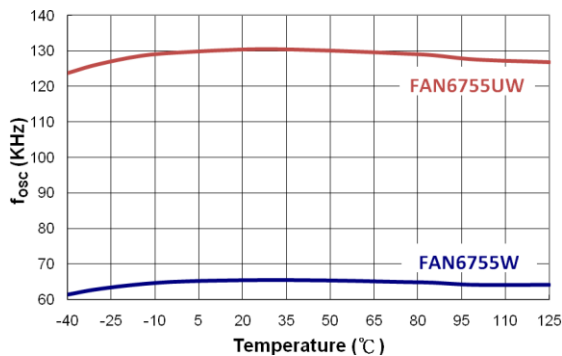

Figure 14. Frequency in Normal Mode ( $f_{osc}$ ) vs. Temperature

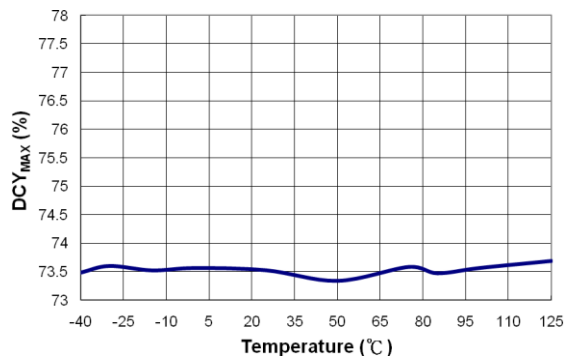

Figure 15. Maximum Duty Cycle ( $DCY_{MAX}$ ) vs. Temperature

Typical Performance Characteristics

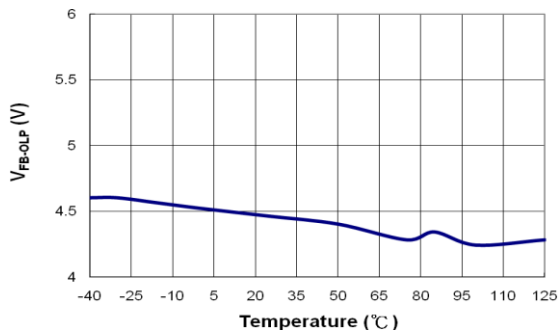

Figure 16. FB Open-Loop Trigger Level (V<sub>FB-OLP</sub>) vs. Temperature

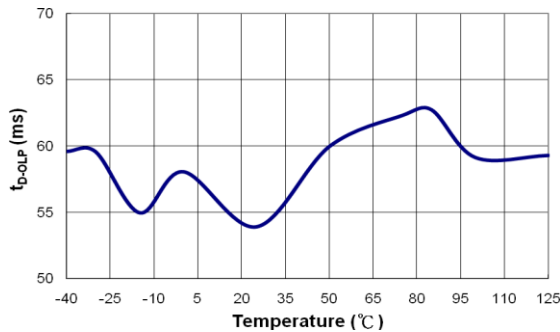

Figure 17. Delay Time of FB Pin Open-Loop Protection (t<sub>D-OLP</sub>) vs. Temperature

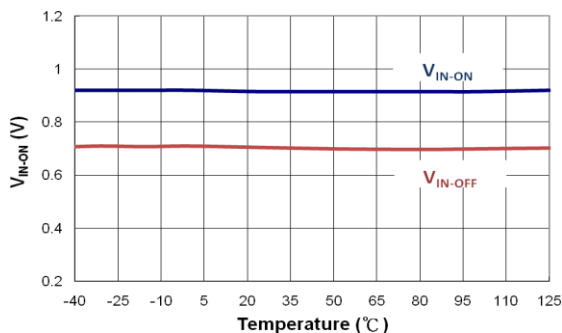

Figure 18. PWM Turn-Off Threshold Voltage (V<sub>IN-OFF</sub> & V<sub>IN-ON</sub>) vs. Temperature

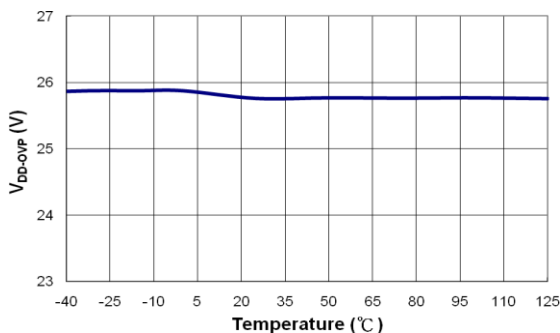

Figure 19. V<sub>DD</sub> Over-Voltage Protection (V<sub>DD-OVP</sub>) vs. Temperature

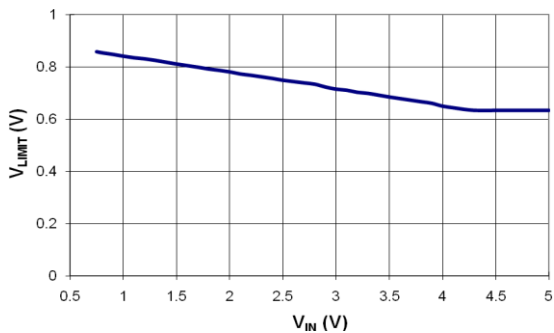

Figure 20. V<sub>IN</sub> vs. V<sub>LIMIT</sub>

## Functional Description

### Startup Current

For startup, the HV pin is connected to the line input or bulk capacitor in series with diodes and/or resistors. If HV pin is connected to the line input, a 1-kV/ 1-A diode and a 100 k $\Omega$  resistor are recommended. If HV pin is connected to the bulk capacitor, only the resistor is required. Startup current drawn from pin HV (typically 3.5 mA) charges the hold-up capacitor through the diode and resistor. When the  $V_{DD}$  capacitor level reaches  $V_{DD-ON}$ , the startup current switches off. At this moment, only the  $V_{DD}$  capacitor supplies the FAN6755W/UW to maintain  $V_{DD}$  before the auxiliary winding of the main transformer to provide the operating current.

### Operating Current

Operating current is below 2 mA. The low operating current enables better efficiency and reduces the requirement of  $V_{DD}$  hold-up capacitance.

### Green-Mode Operation

The proprietary green-mode function provides an off-time modulation to reduce the switching frequency in light-load and no-load conditions. The on time is limited for better abnormal or brownout protection.  $V_{FB}$ , which is derived from the voltage feedback loop, is taken as the reference. Once  $V_{FB}$  is lower than the threshold voltage, switching frequency is continuously decreased to the minimum green-mode frequency of around 23 kHz.

### Current Sensing / PWM Current Limiting

Peak-current-mode control is utilized to regulate output voltage and provide pulse-by-pulse current limiting. The switching current is detected by the current-sensing resistor of SENSE pin. The PWM duty cycle is determined by this current sense signal and  $V_{FB}$ , the feedback voltage. When the voltage on the SENSE pin reaches around  $V_{COMP}=(V_{FB}-0.6)/4$ , the PWM switching turns off immediately.

### Leading-Edge Blanking (LEB)

Each time the power MOSFET is switched on, a turn-on spike occurs on the sense resistor. To avoid premature termination of the switching pulse, a leading-edge blanking time is built in. During this blanking period, the current-limit comparator is disabled and cannot switch off the gate driver.

### Under-Voltage Lockout (UVLO)

The turn-on and turn-off thresholds are fixed internally at 16 V and 7.8 V in normal mode. During startup, the hold-up capacitor must be charged to 16 V through the startup resistor to enable the IC. The hold-up capacitor continues to supply  $V_{DD}$  before the energy can be delivered from auxiliary winding of the main transformer.  $V_{DD}$  must not drop below 7.8 V during startup. This UVLO hysteresis window ensures that the hold-up capacitor is adequate to supply  $V_{DD}$  during startup.

### Gate Output / Soft Driving

The BiCMOS output stage is a fast totem-pole gate driver. Cross conduction has been avoided to minimize heat dissipation, increase efficiency, and enhance reliability. The output driver is clamped by an internal 18 V Zener diode to protect power MOSFET transistors against undesirable gate over voltage. A soft-driving circuit is implemented to minimize EMI.

### Soft-Start

For many applications, it is necessary to minimize the inrush current at startup. The built-in 5.5 ms soft-start circuit significantly reduces the startup current spike and output voltage overshoot.

### Slope Compensation

The sensed voltage across the current-sense resistor is used for peak-current-mode control and pulse-by-pulse current limiting. Built-in slope compensation improves stability and prevents sub-harmonic oscillation. FAN6755W/UW inserts a synchronized positive-going ramp at every switching cycle as slope compensation.

### Constant Output Power Limit

For constant output power limit over universal input-voltage range, the peak-current threshold is adjusted by the voltage of the VIN pin. Since the VIN pin is connected to the rectified AC input line voltage through the resistive divider, a higher line voltage generates a higher  $V_{IN}$  voltage. The threshold voltage decreases as  $V_{IN}$  increases, making the maximum output power at high-line input voltage equal to that at low-line input. The value of R-C network should not be so large that it affects the power limit (shown in Figure 21). R and C should be less than 100  $\Omega$  and 470 pF, respectively.

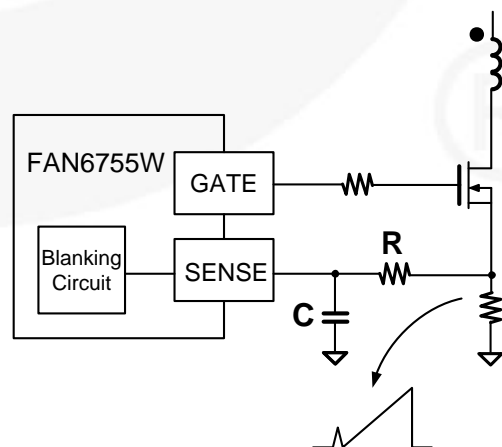

Figure 21. Current-Sense R-C Filter

## V<sub>DD</sub> Over-Voltage Protection

V<sub>DD</sub> over-voltage protection prevents damage due to abnormal conditions. Once the V<sub>DD</sub> voltage is over the over-voltage protection voltage (V<sub>DD-OVP</sub>), and lasts for t<sub>DVDDOVP</sub>, the PWM pulses are disabled. When the V<sub>DD</sub> voltage drops below the UVLO, the internal startup circuit turns on, and V<sub>DD</sub> is charged to V<sub>DD-ON</sub> to restart IC.

## Feedback Impedance Switching

FAN6755W/UW actively varies FB-pin impedance (Z<sub>FB</sub>) to reduce no-load power consumption. This technique can further reduce operating current of the controller when FB-pin voltage drops below V<sub>FB-ZDC</sub>. Figure 22 exhibits the range that Z<sub>FB</sub> changes. When V<sub>FB</sub> is lower than V<sub>FB-ZDC</sub>, PWM switching is stopped and Z<sub>FB</sub> is switched from 15 kΩ to 90 kΩ. On the other hand, Z<sub>FB</sub> is switched from 90 kΩ to 15 kΩ when V<sub>FB</sub> is higher than V<sub>FB-ZDCR</sub>.

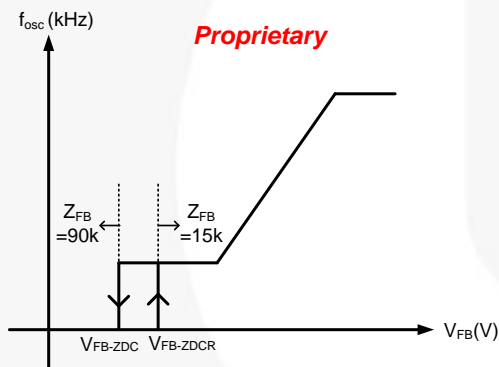

Figure 22. Z<sub>FB</sub>-Switching Activating Range

## Brownout Protection

Since the V<sub>IN</sub> pin is connected through a resistive divider to the rectified AC input line voltage, it can also be used for brownout protection. If V<sub>IN</sub> is less than 0.7 V, the PWM output is shut off. When V<sub>IN</sub> reaches over 0.9 V, the PWM output is turned on again. The hysteresis window for ON/OFF is around 0.2 V. The brownout voltage setting is determined by the potential divider formed with R<sub>Upper</sub> and R<sub>Lower</sub>. Equations to calculate the resistors are shown below:

$$V_{IN} = \frac{R_{Lower}}{R_{Lower} + R_{Upper}} \times V_{AC} \sqrt{2}, (\text{unit} = \text{V}) \quad (1)$$

## Thermal Overload Protection

Thermal overload protection limits total power dissipation. When the junction temperature exceeds T<sub>J</sub> = +140°C, the thermal sensor signals the shutdown logic and turns off most of the internal circuitry. The thermal sensor turns internal circuitry on again after the IC's junction temperature drops by 25°C. Thermal overload protection is designed to protect the FAN6755W/UW in the event of a fault condition. For continual operation, the controller should not exceed the absolute maximum junction temperature of T<sub>J</sub> = +140°C.

## Limited Power Control

The FB voltage is saturated HIGH when the power supply output voltage drops below its nominal value and shut regulator (KA431) does not draw current through the opto-coupler. This occurs when the output feedback loop is open or output is short circuited. If the FB voltage is higher than a built-in threshold for longer than t<sub>D-OLP</sub>, PWM output is turned off. As PWM output is turned off, V<sub>DD</sub> begins decreasing since no more energy is delivered from the auxiliary winding.

As the protection is triggered, V<sub>DD</sub> enters into UVLO mode. This protection feature continues as long as the over loading condition persists. This prevents the power supply from overheating due to overloading conditions.

## Noise Immunity

Noise on the current sense or control signal may cause significant pulse-width jitter, particularly in continuous-conduction mode. Slope compensation helps alleviate this problem. Good placement and layout practices should be followed. Avoiding long PCB traces and component leads, locating compensation and filter components near the FAN6755W/UW, and increasing the gate resistor from GATE pin to MOSFET improve performance.



## Bill of Materials

Designator	Part Type	Designator	Part Type
BD1	BD 4 A/600 V	Q1	MOS 9 A/600 V
C1	YC 2200 pF/Y1	R1	R 1.5 M $\Omega$ 1/4 W
C2	YC 2200 pF/Y1	R2	R 1.5 M $\Omega$ 1/4 W
C3	XC 0.33 $\mu$ F/300 V	R3	R 10 M $\Omega$ 1/4 W
C4	NC	R4, R5, R6, R7	R 47 $\Omega$ 1/4 W
C5	YC 2200 pF/Y1	R8, R17, R25, R27	NC
C6	CC 2200 pF/100 V	R9	R 50 K $\Omega$ 1/4 W
C7	CC 1000 pF/100 V	R10	R 50 K $\Omega$ 1/4 W
C8	EC 1000 $\mu$ F/25 V	R11	R 0 $\Omega$ 1/8 W
C9	EC 470 $\mu$ F/25 V	R12	R 47 $\Omega$ 1/8 W
C10	CC 100 pF/50 V	R13	R 100 K $\Omega$ 1/8 W
C11	EC 100 $\mu$ F/400 V	R14	R 0 $\Omega$ 1/4 W
C12	C 1 $\mu$ F/50 V	R15	R 10 K $\Omega$ 1/8 W
C13	EC 1000 $\mu$ F/10 V	R16	R 1 $\Omega$ 1/8 W
C14	EC 470 $\mu$ F/10 V	R18	R 0 $\Omega$ 1/8 W
C15	CC 100 pF/50 V	R19	R 100 $\Omega$ 1/8 W
C16	C 1 nF/50 V	R20	R 1 K $\Omega$ 1/8 W
C17	C 470 pF/50 V	R21	R 4.7 K $\Omega$ 1/8 W
C18	EC 47 $\mu$ F/50 V	R22	R 7.5 K $\Omega$ 1/8 W
C19	C 0.01 $\mu$ F/50 V	R23	R 120 K $\Omega$ 1/8 W
C20	C 0.1 $\mu$ F/50 V	R24	R 15 K $\Omega$ 1/8 W
D1	FYP1010	R26	R 10 K $\Omega$ 1/8 W
D2	1N4148	R28	R 0.43 $\Omega$ 2 W
D3	FR107	TX1	800 $\mu$ H(ERL-28)
D4	FR103	U1	IC FAN6755W
D5	FYP1010	U2	IC PC817
ZD1	P6KE150A	U3	IC TL431
F1	FUSE 4A/250V		
M1	VZ 9G		
L1	13 mH		
L2	Inductor (2 $\mu$ H)		
L3	Inductor (2 $\mu$ H)		

## Physical Dimensions

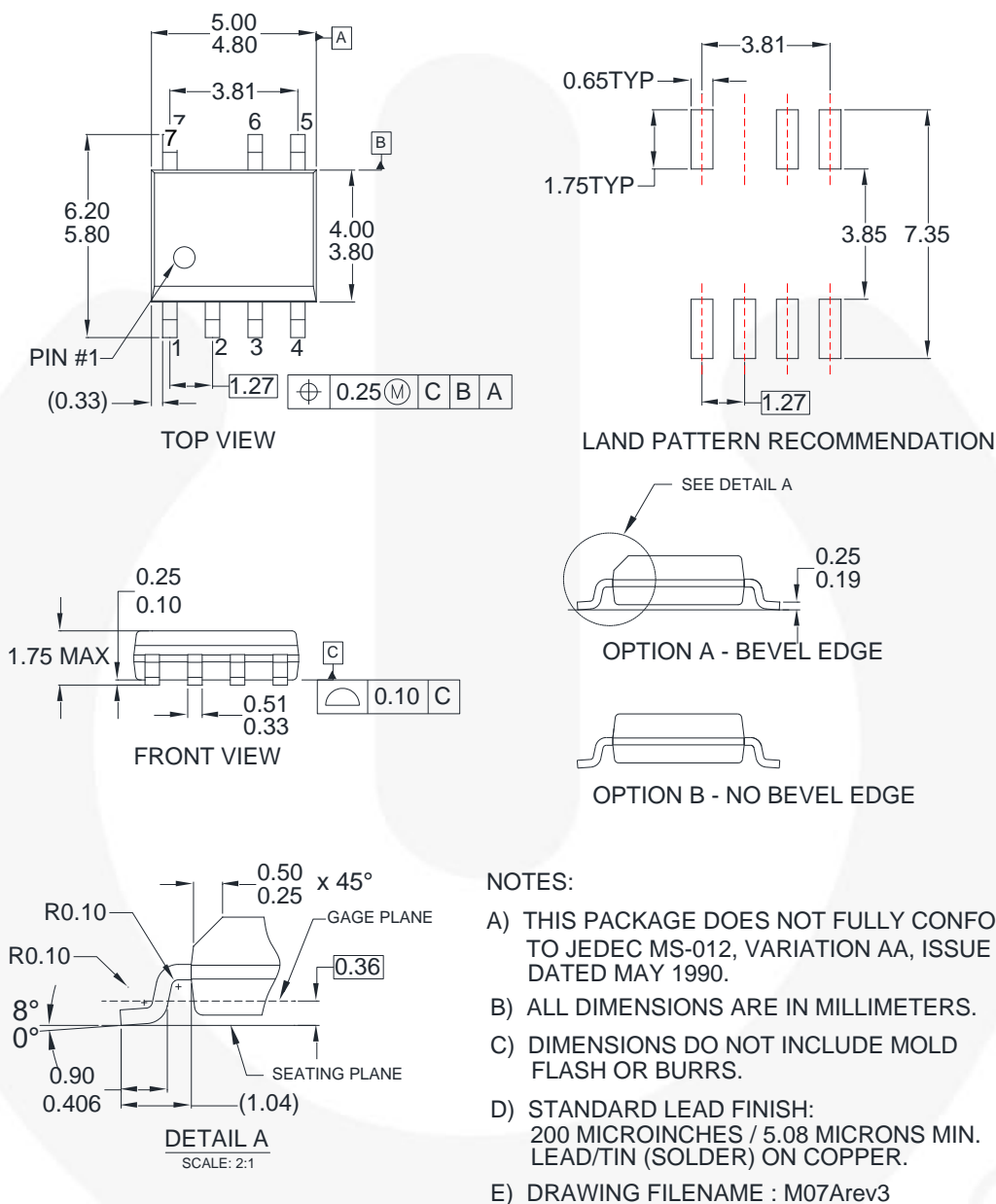

**Figure 24. 7-Lead, Small Outline Package (SOP)**

Package drawings are provided as a service to customers considering Fairchild components. Drawings may change in any manner without notice. Please note the revision and/or date on the drawing and contact a Fairchild Semiconductor representative to verify or obtain the most recent revision. Package specifications do not expand the terms of Fairchild's worldwide terms and conditions, specifically the warranty therein, which covers Fairchild products.

Always visit Fairchild Semiconductor's online packaging area for the most recent package drawings:  
<http://www.fairchildsemi.com/packaging/>.





**TRADEMARKS**

The following includes registered and unregistered trademarks and service marks, owned by Fairchild Semiconductor and/or its global subsidiaries, and is not intended to be an exhaustive list of all such trademarks.

- |   |  |   |   |
|---|--|---|---|
| 2Cool™  | FPST™  |  | Sync-Lock™  |
| AccuPower™  | F-PFST™  | PowerTrench®  |  SYSTEM GENERAL® |
| AX-CAP®*  | FRFET®   | PowerXS™  | TinyBoost™  |
| BitSiC™   | Global Power Resource™                         | Programmable Active Droop™  | TinyBuck™   |
| Build it Now™   | GreenBridge™                                   | QFET®   | TinyCalc™   |
| CorePLUS™   | Green FPS™                                     | QST™  | TinyLogic®  |
| CorePOWER™  | Green FPS™ e-Series™                           | Quiet Series™   | TINYOPTO™   |
| CROSSVOLT™  | Gmax™  | RapidConfigure™   | TinyPower™  |
| CTL™  | GTO™   |  | TinyPWM™  |
| Current Transfer Logic™   | IntelliMAX™                                    | Saving our world, 1mW/W at a time™  | TinyWire™   |
| DEUXPEED®   | ISOPLANAR™                                     | SignalMise™   | TranSiC™  |
| Dual Cool™  | Making Small Speakers Sound Louder and Better™ | SmartMax™   | TriFault Detect™  |
| EcoSPARK®   | MegaBuck™                                      | SMART START™  | TRUECURRENT®*   |
| EfficientMax™   | MICROCOUPLER™                                  | Solutions for Your Success™   | µSerDes™  |
| ESBC™   | MicroFET™                                      | SPM®  |  SerDes™         |
|  | MicroPak™                                      | STEALTH™  | UHC®  |
| Fairchild®  | MicroPak2™                                     | SuperFET®   | Ultra FRFET™  |
| Fairchild Semiconductor®  | MillerDrive™                                   | SuperSOT™-3   | UniFET™   |
| FACT Quiet Series™  | MotionMax™                                     | SuperSOT™-6   | VCX™  |
| FACT®   | mWSaver™                                       | SuperSOT™-8   | VisualMax™  |
| FAST®   | OptoHIT™                                       | SupreMOS®   | VoltagePlus™  |
| FastvCore™  | OPTOLOGIC®                                     | SyncFET™  | XST™  |
| FETBench™   | OPTOPLANAR®                                    |   |   |

\* Trademarks of System General Corporation, used under license by Fairchild Semiconductor.

**DISCLAIMER**

FAIRCHILD SEMICONDUCTOR RESERVES THE RIGHT TO MAKE CHANGES WITHOUT FURTHER NOTICE TO ANY PRODUCTS HEREIN TO IMPROVE RELIABILITY, FUNCTION, OR DESIGN. FAIRCHILD DOES NOT ASSUME ANY LIABILITY ARISING OUT OF THE APPLICATION OR USE OF ANY PRODUCT OR CIRCUIT DESCRIBED HEREIN, NEITHER DOES IT CONVEY ANY LICENSE UNDER ITS PATENT RIGHTS, NOR THE RIGHTS OF OTHERS. THESE SPECIFICATIONS DO NOT EXPAND THE TERMS OF FAIRCHILD'S WORLDWIDE TERMS AND CONDITIONS, SPECIFICALLY THE WARRANTY THEREIN, WHICH COVERS THESE PRODUCTS.

**LIFE SUPPORT POLICY**

FAIRCHILD'S PRODUCTS ARE NOT AUTHORIZED FOR USE AS CRITICAL COMPONENTS IN LIFE SUPPORT DEVICES OR SYSTEMS WITHOUT THE EXPRESS WRITTEN APPROVAL OF FAIRCHILD SEMICONDUCTOR CORPORATION.

As used herein:

1. Life support devices or systems are devices or systems which, (a) are intended for surgical implant into the body or (b) support or sustain life, and (c) whose failure to perform when properly used in accordance with instructions for use provided in the labeling, can be reasonably expected to result in a significant injury of the user.
2. A critical component in any component of a life support, device, or system whose failure to perform can be reasonably expected to cause the failure of the life support device or system, or to affect its safety or effectiveness.

**ANTI-COUNTERFEITING POLICY**

Fairchild Semiconductor Corporation's Anti-Counterfeiting Policy. Fairchild's Anti-Counterfeiting Policy is also stated on our external website, [www.fairchildsemi.com](http://www.fairchildsemi.com), under Sales Support.

Counterfeiting of semiconductor parts is a growing problem in the industry. All manufacturers of semiconductor products are experiencing counterfeiting of their parts. Customers who inadvertently purchase counterfeit parts experience many problems such as loss of brand reputation, substandard performance, failed applications, and increased cost of production and manufacturing delays. Fairchild is taking strong measures to protect ourselves and our customers from the proliferation of counterfeit parts. Fairchild strongly encourages customers to purchase Fairchild parts either directly from Fairchild or from Authorized Fairchild Distributors who are listed by country on our web page cited above. Products customers buy either from Fairchild directly or from Authorized Fairchild Distributors are genuine parts, have full traceability, meet Fairchild's quality standards for handling and storage and provide access to Fairchild's full range of up-to-date technical and product information. Fairchild and our Authorized Distributors will stand behind all warranties and will appropriately address any warranty issues that may arise. Fairchild will not provide any warranty coverage or other assistance for parts bought from Unauthorized Sources. Fairchild is committed to combat this global problem and encourage our customers to do their part in stopping this practice by buying direct or from authorized distributors.

**PRODUCT STATUS DEFINITIONS**

**Definition of Terms**

Datasheet Identification	Product Status	Definition
Advance Information	Formative / In Design	Datasheet contains the design specifications for product development. Specifications may change in any manner without notice.
Preliminary	First Production	Datasheet contains preliminary data; supplementary data will be published at a later date. Fairchild Semiconductor reserves the right to make changes at any time without notice to improve design.
No Identification Needed	Full Production	Datasheet contains final specifications. Fairchild Semiconductor reserves the right to make changes at any time without notice to improve the design.
Obsolete	Not In Production	Datasheet contains specifications on a product that is discontinued by Fairchild Semiconductor. The datasheet is for reference information only.

Rev. 164