



## GaAs PHEMT MMIC MEDIUM POWER AMPLIFIER, 34 - 46.5 GHz

### Typical Applications

The HMC1016 is ideal for:

- Point-to-Point Radios
- Point-to-Multi-Point Radios
- VSAT & SATCOM
- Military & Space

### Features

- P1dB Output Power: +24 dBm
- Psat Output Power: +26 dBm
- High Gain: 22 dB
- Output IP3: +34 dBm
- Supply Voltage: Vdd = +6V @ 250 mA
- 50 Ohm Matched Input/Output
- Die Size: 0.90 x 2.22 x 0.1 mm

### Functional Diagram

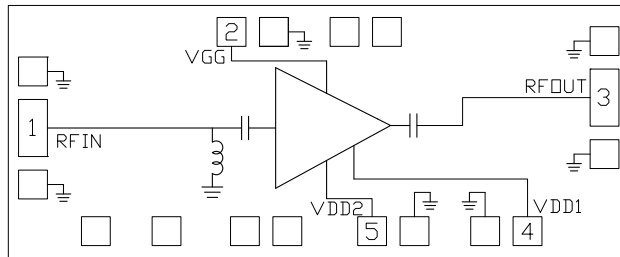

### General Description

The HMC1016 is a four stage GaAs PHEMT MMIC Medium Power Amplifier die which operates between 34 and 46.5 GHz. The amplifier provides 22 dB of gain, +26 dBm of saturated output power, and 17% PAE from a +6V supply. With up to +37 dBm IP3 the HMC1016 is ideal for high linearity applications in military and space as well as point-to-point and point-to-multi-point radios. The HMC1016 amplifier I/Os are internally matched facilitating integration into mutli-chip-modules (MCMs). All data shown herein was measured with the chip connected via two 0.025mm (1 mil) wire bonds of minimal length 0.31 mm (12 mils).

### Electrical Specifications, $T_A = +25^\circ C$ , $V_{dd} = V_{dd1} = V_{dd2} = +6V$ , $I_{dd} = 250 mA$ [1]

Parameter	Min.	Typ.	Max.	Min.	Typ.	Max.	Units
Frequency Range		34 - 40			40 - 46.5		GHz
Gain	19	22		20	23		dB
Gain Variation Over Temperature		0.028			0.038		dB/ °C
Input Return Loss		13			18		dB
Output Return Loss		11			12		dB
Output Power for 1 dB Compression (P1dB)	21	24		21	24		dBm
Saturated Output Power (Psat)		26			26		dBm
Output Third Order Intercept (IP3) [2]		34			34		dBm
Total Supply Current		250			250		mA

[1] Adjust Vgg between -2 to 0V to achieve Idd = 250 mA typical.

[2] Measurement taken at Pout / tone = +14 dBm.



**GaAs PHEMT MMIC  
MEDIUM POWER AMPLIFIER, 34 - 46.5 GHz**

**Gain & Return Loss**

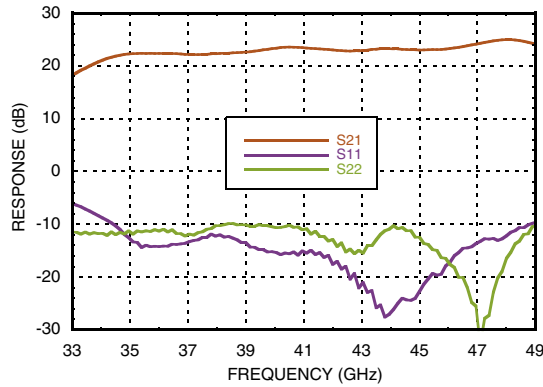

**Gain vs. Temperature**

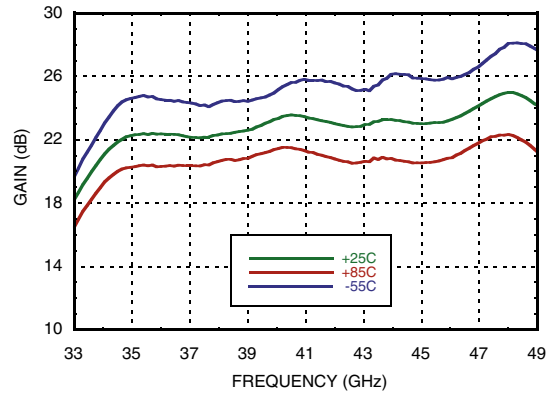

**Input Return Loss vs. Temperature**

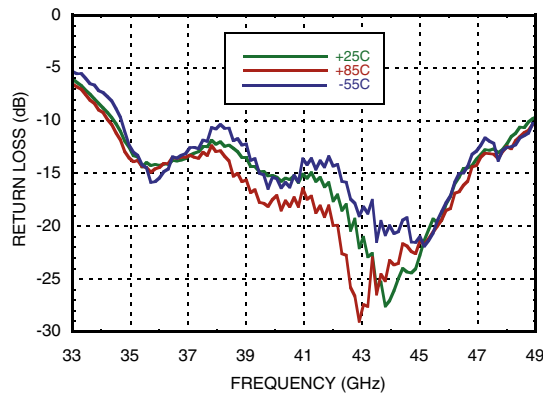

**Output Return Loss vs. Temperature**

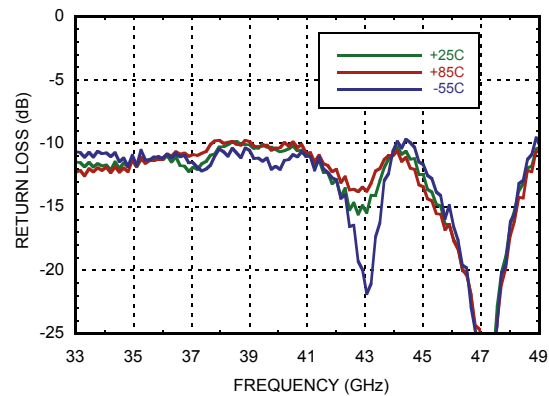

**P1dB vs. Temperature**

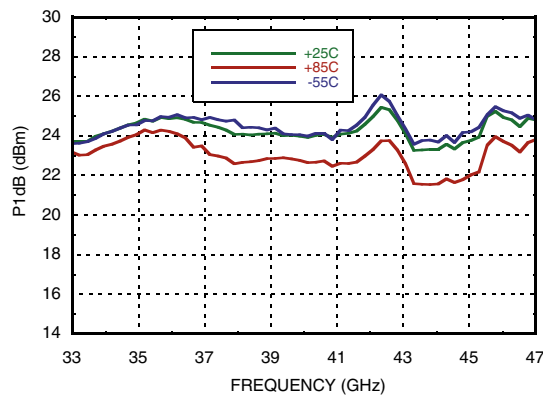

**P1dB vs. Supply Voltage**

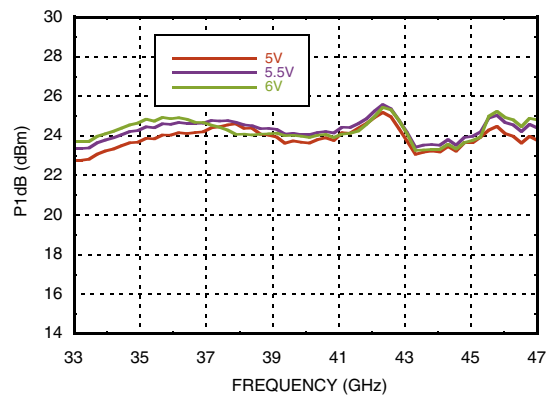



**GaAs PHEMT MMIC  
MEDIUM POWER AMPLIFIER, 34 - 46.5 GHz**

AMPLIFIERS - LINEAR & POWER - CHIP

**Psat vs. Temperature**

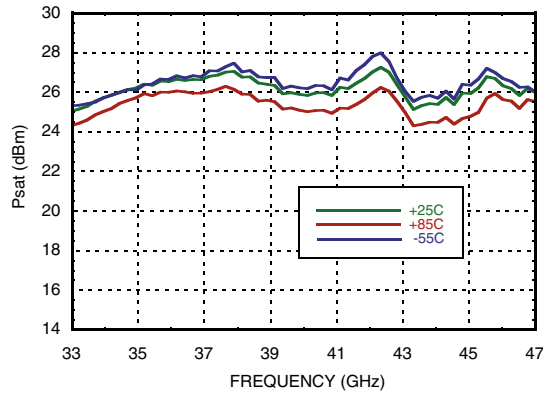

**Psat vs. Supply Voltage**

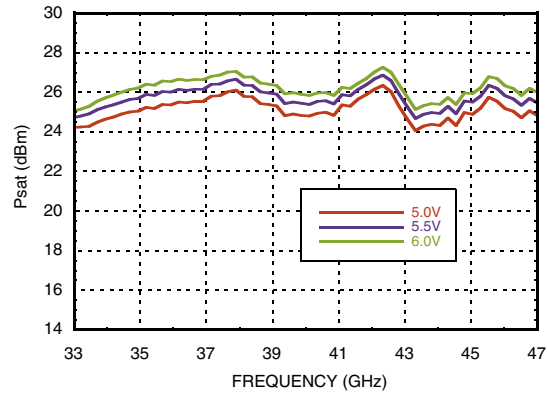

**P1dB vs. Supply Current**

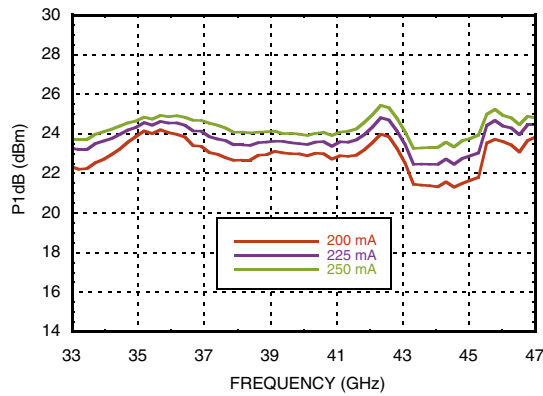

**Psat vs. Supply Current**

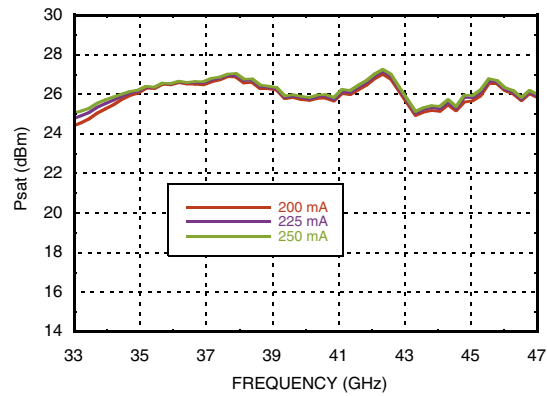

**Output IP3 vs. Temperature,  
Pout/tone = +14 dBm**

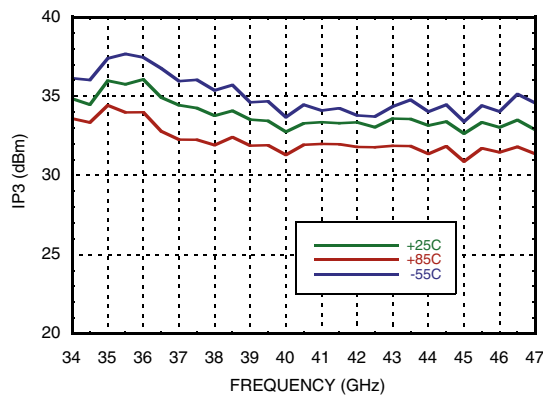

**Output IP3 vs. Supply Current,  
Pout/tone = +14 dBm**

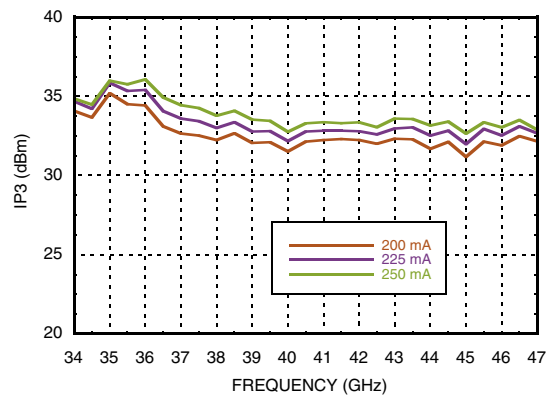



## GaAs PHEMT MMIC MEDIUM POWER AMPLIFIER, 34 - 46.5 GHz

**Output IP3 vs. Supply Voltage,  
Pout/tone = +14 dBm**

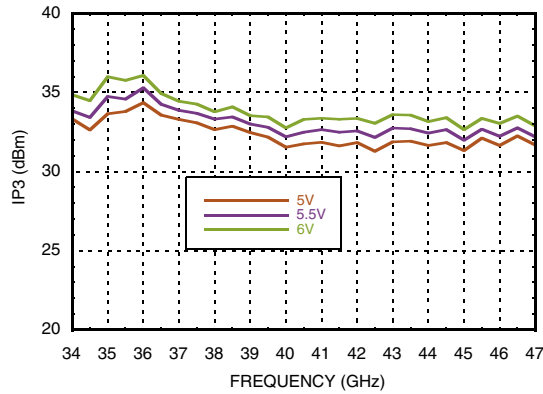

**Output IM3 @ Vdd = +5V**

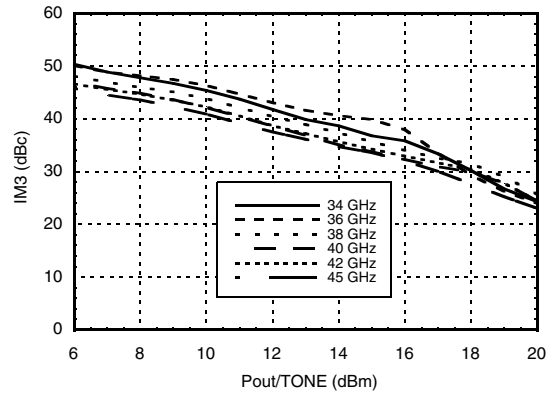

**Output IM3 @ Vdd = +5.5V**

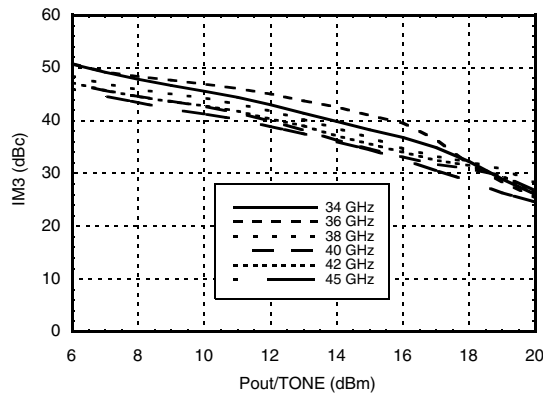

**Output IM3 @ Vdd = +6V**

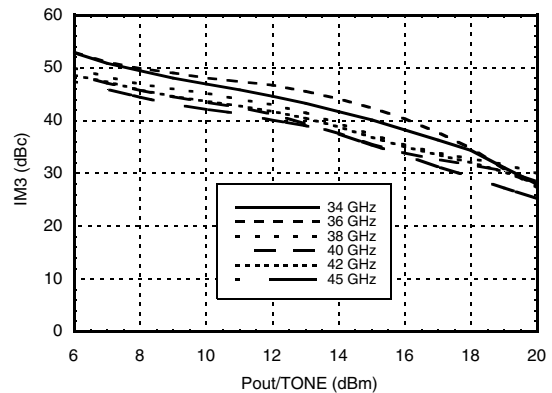

**Power Compression @ 40 GHz**

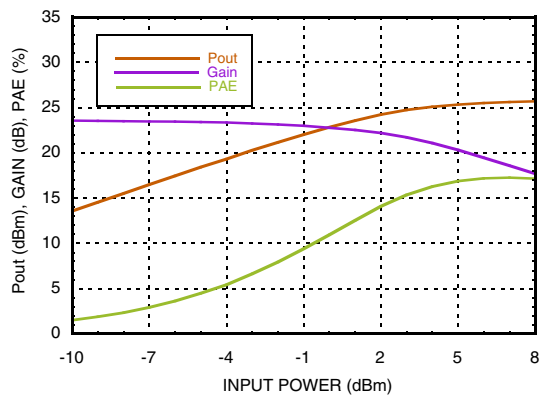

**Reverse Isolation vs. Temperature**

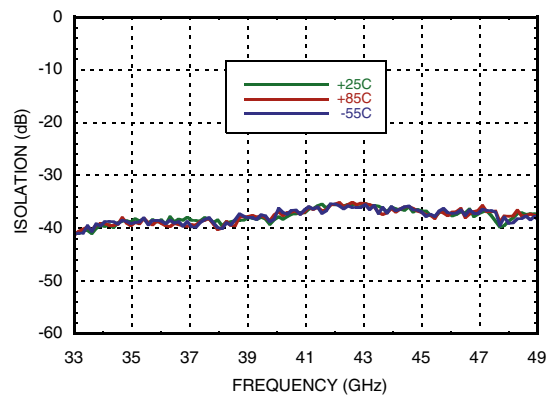



**GaAs PHEMT MMIC  
MEDIUM POWER AMPLIFIER, 34 - 46.5 GHz**

**Gain & Power vs.  
Supply Current @ 40 GHz**

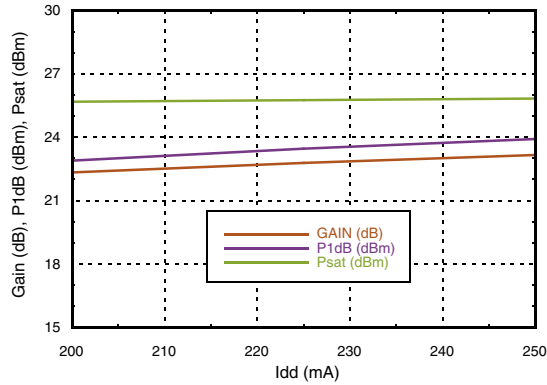

**Gain & Power vs.  
Supply Voltage @ 40 GHz**

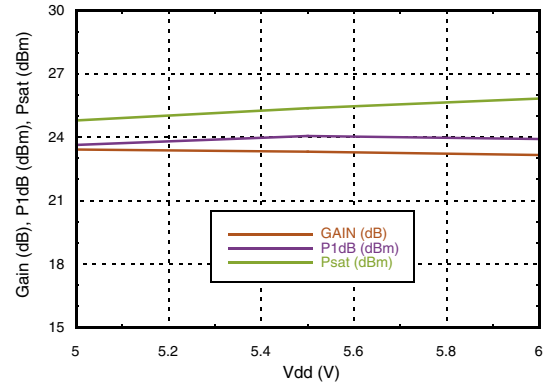

**Power Dissipation**

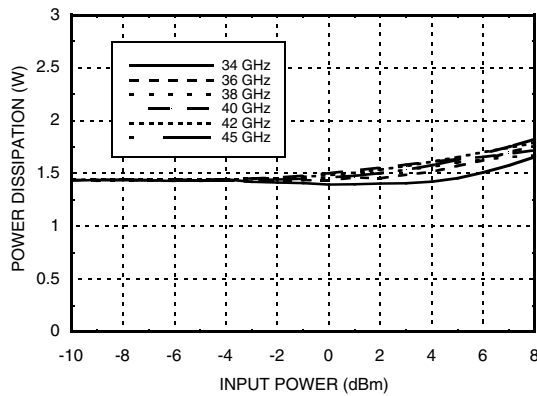

**Absolute Maximum Ratings**

Drain Bias Voltage (Vdd)	+7 Vdc
Gate Bias Voltage (Vgg)	-3 to 0 Vdc
RF Input Power (RFIN)	+15 dBm
Channel Temperature	150 °C
Continuous Pdiss (T= 85 °C) (derate 24 mW/°C above 85 °C)	1.57 W
Thermal Resistance (channel to die bottom)	41.3 °C/W
Storage Temperature	-65 to 150°C
Operating Temperature	-55 to 85 °C

**Typical Supply Current vs. Vdd**

Vdd (V)	Idd (mA)
+5	250
+5.5	250
+6	250

Adjust Vgg1 to achieve Idd = 250 mA



**ELECTROSTATIC SENSITIVE DEVICE  
OBSERVE HANDLING PRECAUTIONS**



**GaAs PHEMT MMIC  
MEDIUM POWER AMPLIFIER, 34 - 46.5 GHz**

**Outline Drawing**

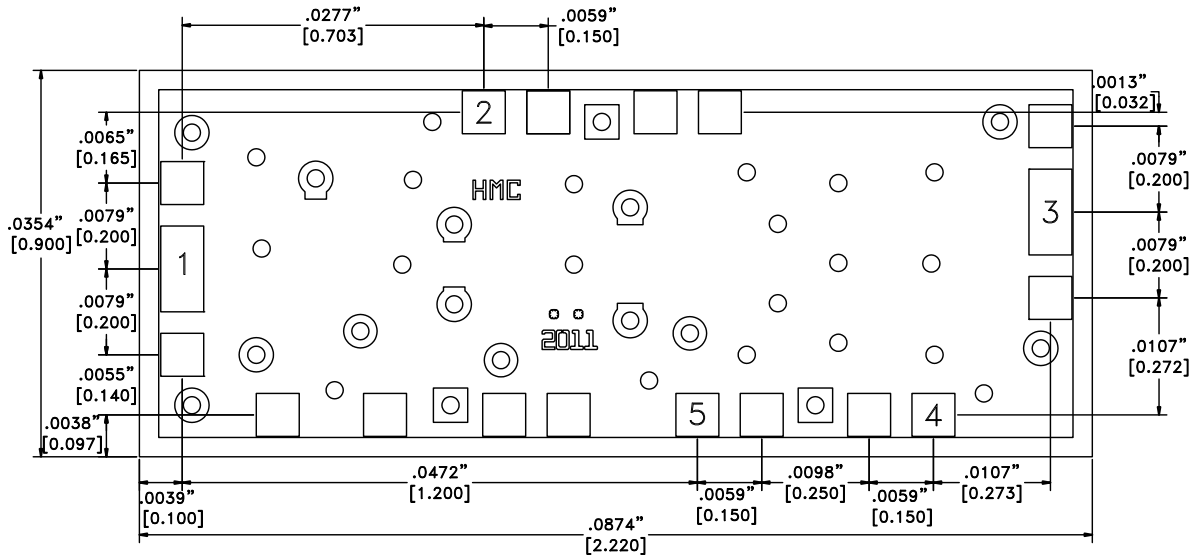

**Die Packaging Information [1]**

Standard	Alternate
GP-1 (Gel Pack)	[2]

[1] For more information refer to the "Packaging Information" Document in the Product Support Section of our website.

[2] For alternate packaging information contact Hittite Microwave Corporation.



**NOTES:**

1. ALL DIMENSIONS ARE IN INCHES [MM]
2. DIE THICKNESS IS 0.004"
3. TYPICAL BOND PAD IS 0.004" SQUARE
4. BOND PAD METALIZATION: GOLD
5. BACKSIDE METALIZATION: GOLD
6. BACKSIDE METAL IS GROUND
7. NO CONNECTION REQUIRED FOR UNLABELED BOND PADS
8. OVERALL DIE SIZE ±0.002"

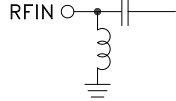
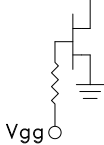
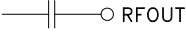
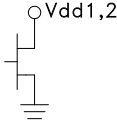

**GaAs PHEMT MMIC**  
**MEDIUM POWER AMPLIFIER, 34 - 46.5 GHz**

**Pad Descriptions**

Pad Number	Function	Description	Interface Schematic
1	RFIN	This pad is DC coupled and matched to 50 Ohms.	
2	Vgg	Gate control for PA. Adjust Vgg to achieve recommended-bias current. External bypass capacitors 100 pF, 10 nF, and 4.7 μF are required.	
3	RFOUT	This pad is AC coupled and matched to 50 Ohms.	
4, 5	Vdd1, Vdd2	Drain bias voltage. External bypass capacitors of 100pF, 10 nF, and 4.7uF are required for each pad.	
Die Bottom	GND	Die bottom must be connected to RF/DC ground.	



**GaAs PHEMT MMIC  
MEDIUM POWER AMPLIFIER, 34 - 46.5 GHz**

**Assembly Diagram**

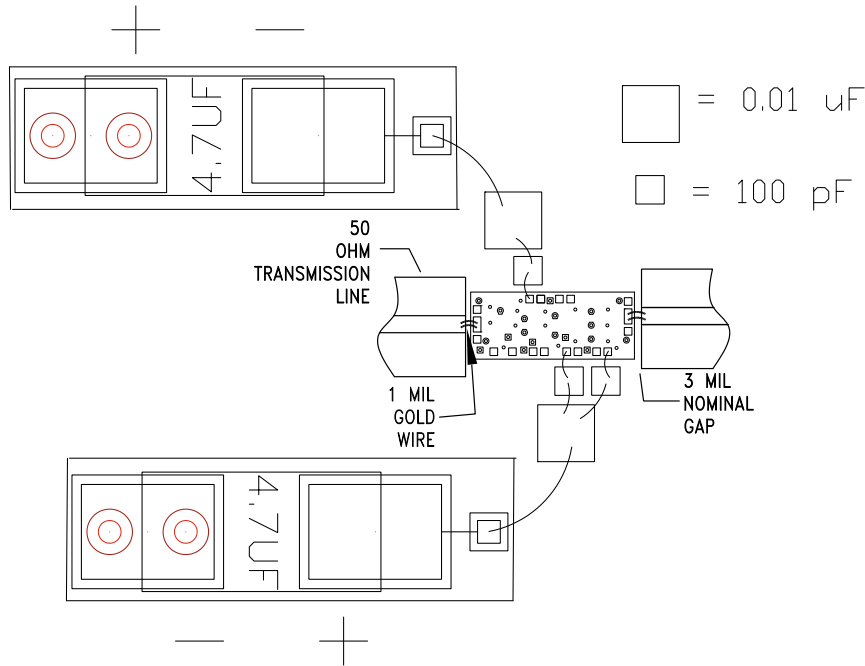

**Application Circuit**

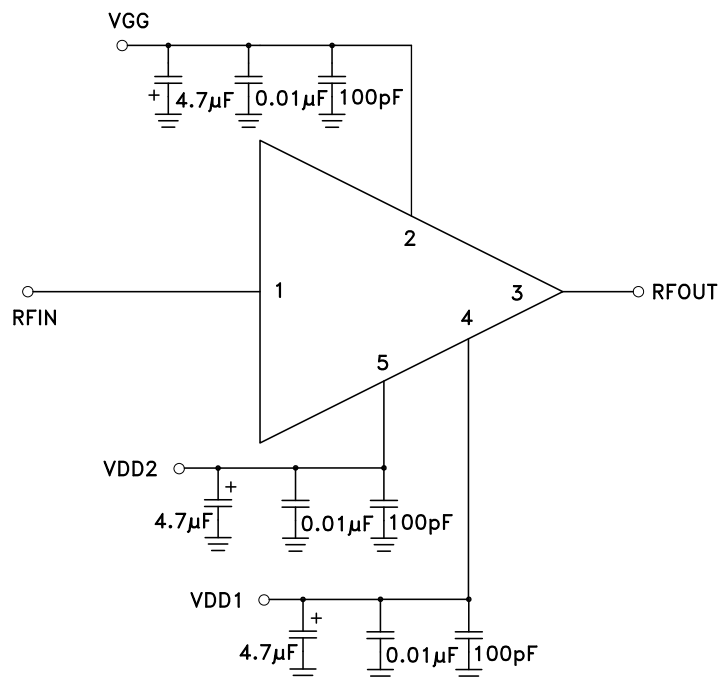





**GaAs PHEMT MMIC  
MEDIUM POWER AMPLIFIER, 34 - 46.5 GHz**

**Mounting & Bonding Techniques for Millimeterwave GaAs MMICs**

The die should be attached directly to the ground plane eutectically or with conductive epoxy (see HMC general Handling, Mounting, Bonding Note).

50 Ohm Microstrip transmission lines on 0.127mm (5 mil) thick alumina thin film substrates are recommended for bringing RF to and from the chip (Figure 1). If 0.254mm (10 mil) thick alumina thin film substrates must be used, the die should be raised 0.150mm (6 mils) so that the surface of the die is coplanar with the surface of the substrate. One way to accomplish this is to attach the 0.102mm (4 mil) thick die to a 0.150mm (6 mil) thick molybdenum heat spreader (moly-tab) which is then attached to the ground plane (Figure 2).

Microstrip substrates should be located as close to the die as possible in order to minimize bond wire length. Typical die-to-substrate spacing is 0.076mm to 0.152 mm (3 to 6 mils).

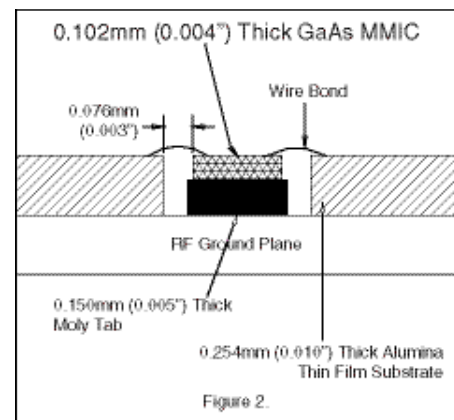
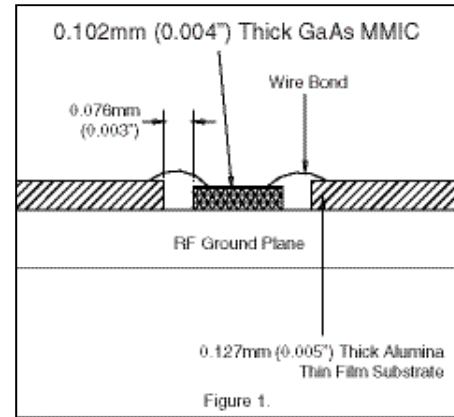

**Handling Precautions**

Follow these precautions to avoid permanent damage.

**Storage:** All bare die are placed in either Waffle or Gel based ESD protective containers, and then sealed in an ESD protective bag for shipment. Once the sealed ESD protective bag has been opened, all die should be stored in a dry nitrogen environment.

**Cleanliness:** Handle the chips in a clean environment. DO NOT attempt to clean the chip using liquid cleaning systems.

**Static Sensitivity:** Follow ESD precautions to protect against > ± 250V ESD strikes.

**Transients:** Suppress instrument and bias supply transients while bias is applied. Use shielded signal and bias cables to minimize inductive pick-up.

**General Handling:** Handle the chip along the edges with a vacuum collet or with a sharp pair of bent tweezers. The surface of the chip may have fragile air bridges and should not be touched with vacuum collet, tweezers, or fingers.

**Mounting**

The chip is back-metallized and can be die mounted with AuSn eutectic preforms or with electrically conductive epoxy. The mounting surface should be clean and flat.

**Eutectic Die Attach:** A 80/20 gold tin preform is recommended with a work surface temperature of 255 °C and a tool temperature of 265 °C. When hot 90/10 nitrogen/hydrogen gas is applied, tool tip temperature should be 290 °C. DO NOT expose the chip to a temperature greater than 320 °C for more than 20 seconds. No more than 3 seconds of scrubbing should be required for attachment.

**Epoxy Die Attach:** Apply a minimum amount of epoxy to the mounting surface so that a thin epoxy fillet is observed around the perimeter of the chip once it is placed into position. Cure epoxy per the manufacturer’s schedule.

**Wire Bonding**

Ball or wedge bond with 0.025mm (1 mil) diameter pure gold wire. Thermosonic wirebonding with a nominal stage temperature of 150 °C and a ball bonding force of 40 to 50 grams or wedge bonding force of 18 to 22 grams is recommended. Use the minimum level of ultrasonic energy to achieve reliable wirebonds. Wirebonds should be started on the chip and terminated on the package or substrate. All bonds should be as short as possible <0.31mm (12 mils).



MICROWAVE CORPORATION v00\_1111

**HMC1016**



**GaAs PHEMT MMIC  
MEDIUM POWER AMPLIFIER, 34 - 46.5 GHz**

**Notes:**

AMPLIFIERS - LINEAR & POWER - CHIP

For price, delivery and to place orders: Hittite Microwave Corporation, 2 Elizabeth Drive, Chelmsford, MA 01824

Phone: 978-250-3343 Fax: 978-250-3373 Order On-line at [www.hittite.com](http://www.hittite.com)

Application Support Phone: 978-250-3343 or [apps@hittite.com](mailto:apps@hittite.com)

[www.BDTIC.com/Hittite/](http://www.BDTIC.com/Hittite/)