



## GaAs MMIC DOUBLE-BALANCED MIXER, 6 - 20 GHz

### Typical Applications

The HMC144LC4 is ideal for:

- Point-to-Point Radios
- Point-to-Multit-Point Radios & VSAT
- Test Equipment & Sensors
- Military End-Use

### Features

- +23 dBm Input IP3
- 35 dB LO/RF Isolation
- IF Bandwidth: DC to 3 GHz
- RoHS Compliant 4x4 mm SMT Package

### Functional Diagram

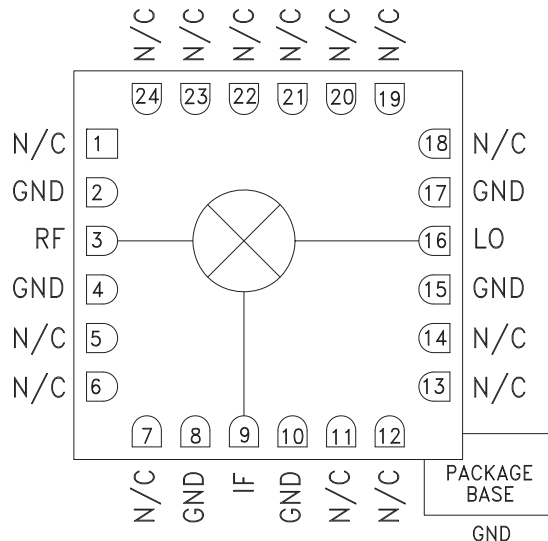

### General Description

The HMC144LC4 is a Double-Balanced MMIC Mixer in a leadless "Pb free" SMT package which can be used as an upconverter or downconverter from 6 to 20 GHz. Broadband operation and 30 to 40 dB isolations are provided by on-chip baluns, which require no external components or DC bias. MMIC mixers are more reliable replacements to hybrid diode mixers assuring consistent conversion loss and isolation performance over high volume production lots. The HMC144LC4 eliminates the need for wire bonding, allowing use of surface mount manufacturing techniques.

### Electrical Specifications, $T_A = +25^\circ C$

Parameter	IF = 100 MHz LO = +20 dBm						Units
	Min.	Typ.	Max.	Min.	Typ.	Max.	
Frequency Range, RF & LO	6 - 12			12 - 20			GHz
Frequency Range, IF	DC - 3			DC - 3			GHz
Conversion Loss		9.5	11.5		11	13	dB
Noise Figure (SSB)		9.5	11.5		11	13	dB
LO to RF Isolation	25	35		25	35		dB
LO to IF Isolation	15	20		15	20		dB
RF to IF Isolation	15	25		15	25		dB
IP3 (Input)		23			23		dBm
1 dB Compression (Input)	12	15		12	15		dBm

\* Unless otherwise noted, all measurements performed as downconverter, IF= 100 MHz.

For price, delivery, and to place orders, please contact Hittite Microwave Corporation:  
20 Alpha Road, Chelmsford, MA 01824 Phone: 978-250-3343 Fax: 978-250-3373

Order On-Line at [www.hittite.com](http://www.hittite.com)  
**www.BDTIC.com/Hittite/**



## GaAs MMIC DOUBLE-BALANCED MIXER, 6 - 20 GHz

**Conversion Gain vs. Temperature @ LO = +20 dBm**

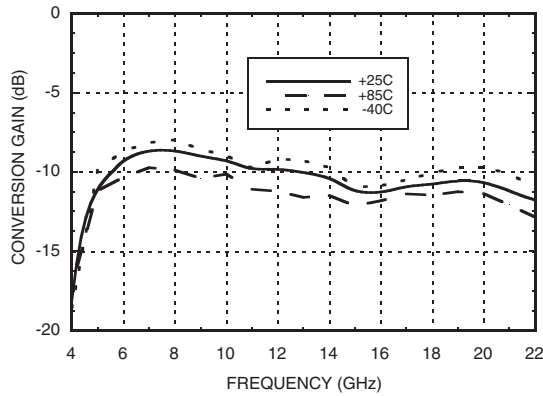

**Isolation @ LO = +20 dBm**

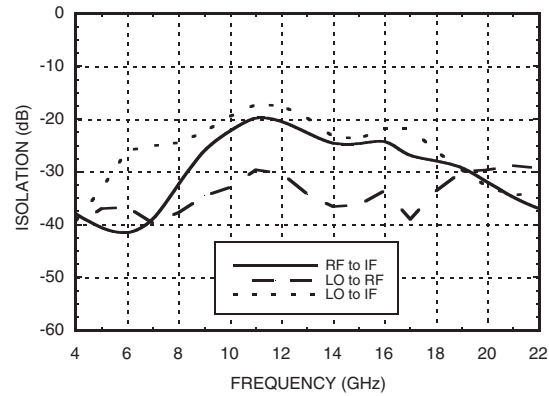

**Conversion Gain vs. LO Drive**

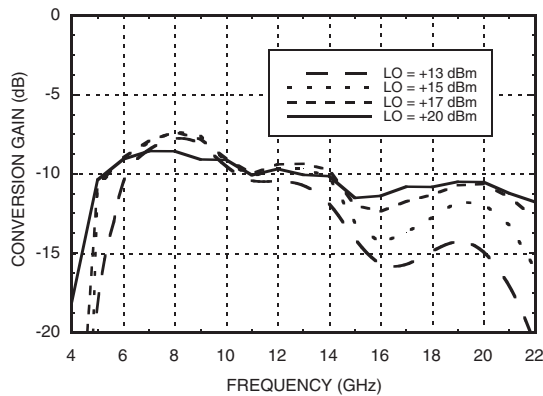

**Return Loss @ LO = +20 dBm**

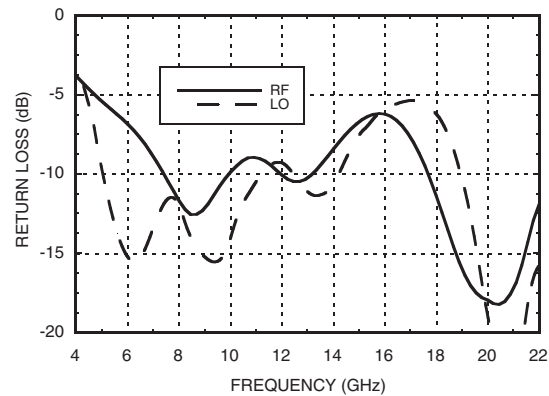

**IF Bandwidth @ LO = +20 dBm**

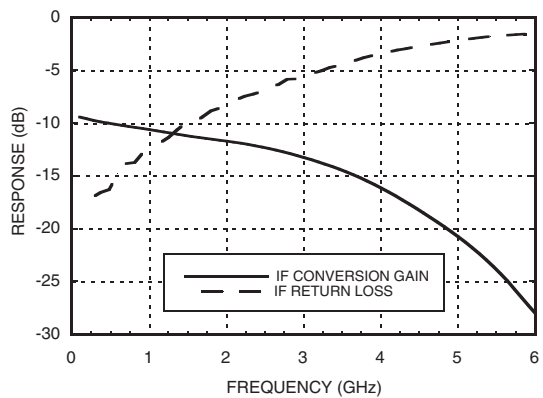

**Upconverter Performance Conversion Gain @ LO = +20 dBm**

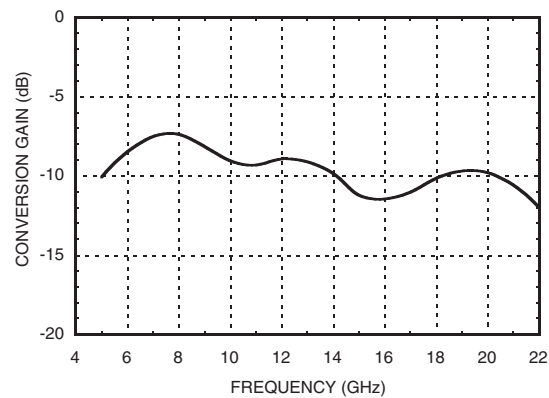



## GaAs MMIC DOUBLE-BALANCED MIXER, 6 - 20 GHz

9

MIXERS - SINGLE & DOUBLE BALANCED - SMT

**Input IP3 vs. LO Drive\***

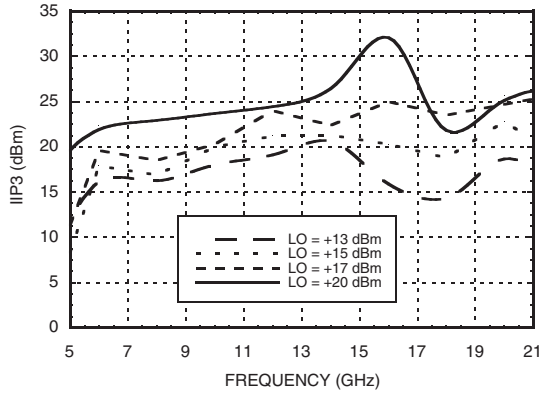

**Input IP3 vs. Temperature @ LO = +20 dBm\***

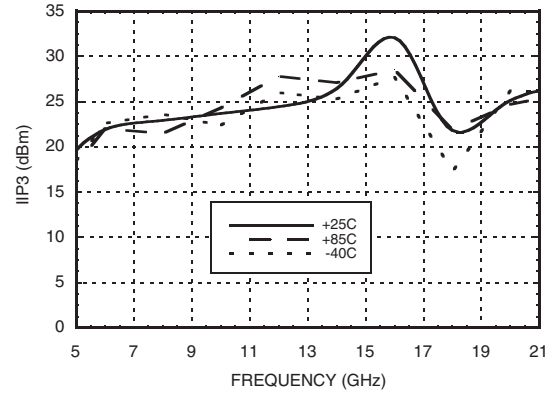

**Input IP2 vs. LO Drive \***

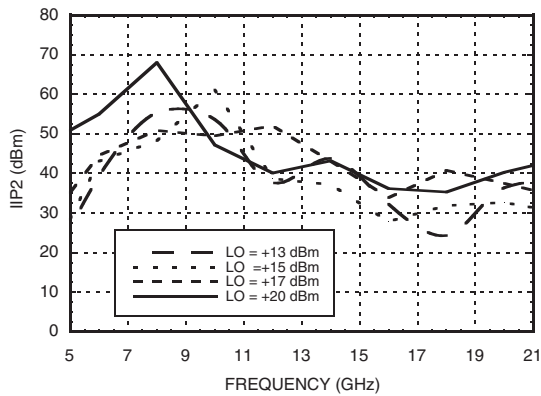

**Input P1dB vs. Temperature @ LO = +20 dBm**

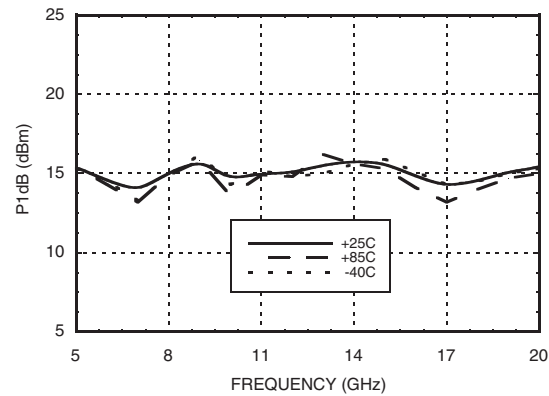

**MxN Spurious @ IF Port**

mRF	nLO				
	0	1	2	3	4
0	XX	0	5	37	N/A
1	7	0	49	42	54
2	47	66	44	56	57
3	>95	>95	>95	58	77
4	N/A	>95	>95	>95	>95

RF = 12 GHz @ -10 dBm  
 LO = 12.1 GHz @ 20 dBm  
 All values in dBc relative to the IF power level.  
 Measured as downconverter.

**Harmonics of LO**

LO Freq. (GHz)	nLO Spur @ RF Port			
	1	2	3	4
9	25	18	46	53
10.5	25	20	52	66
12	27	24	47	63
13.5	27	33	61	N/A
15	27	47	67	N/A
16.5	24	52	63	N/A

LO = +20 dBm  
 All values in dBc below input LO level @ RF port.

\* Two-tone input power = 0 dBm each tone, 1 MHz spacing.

**Absolute Maximum Ratings**

RF / IF Input	+15 dBm
LO Drive	+27 dBm
IF DC Current	±2 mA
Storage Temperature	-65 to +150 °C
Operating Temperature	-40 to +85 °C
ESD Sensitivity (HBM)	Class 1A



**ELECTROSTATIC SENSITIVE DEVICE  
OBSERVE HANDLING PRECAUTIONS**

**Outline Drawing**

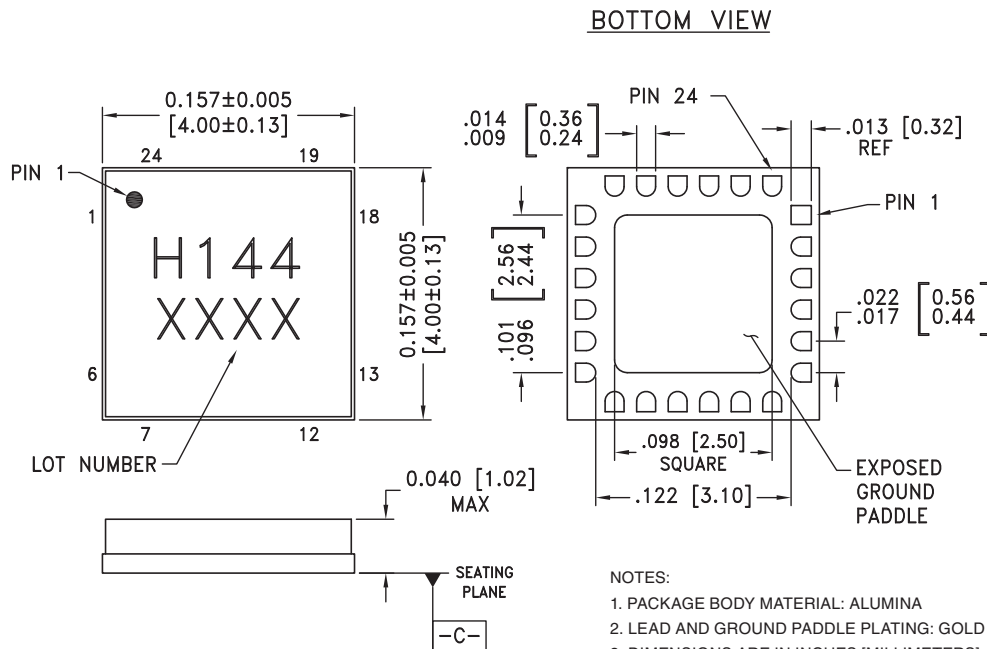

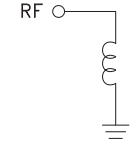
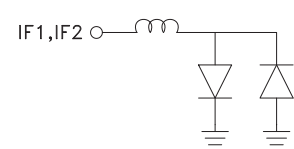
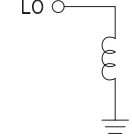

**Pin Descriptions**

Pin Number	Function	Description	Interface Schematic
1, 5 - 7, 11 - 14, 18 - 24	N/C	No Connection. These pins may be connected to RF/DC ground. Performance will not be affected.	
2, 4, 8, 10, 15, 17	GND	These pins and package bottom must be connect to RF/DC ground.	
3	RF	This pin is AC coupled and matched to 50 Ohms from 6 - 20 GHz	
9	IF	This pin is DC coupled. For applications not requiring operation to DC, this port should be DC blocked externally using a series capacitor whose value has been chosen to pass the necessary IF frequency range. For operation to DC, this pin must not source/sink more than 2 mA of current or die non-function and possible die failure will result.	
16	LO	This pin is AC coupled and matched to 50 Ohms from 6 - 20 GHz	

### Evaluation PCB

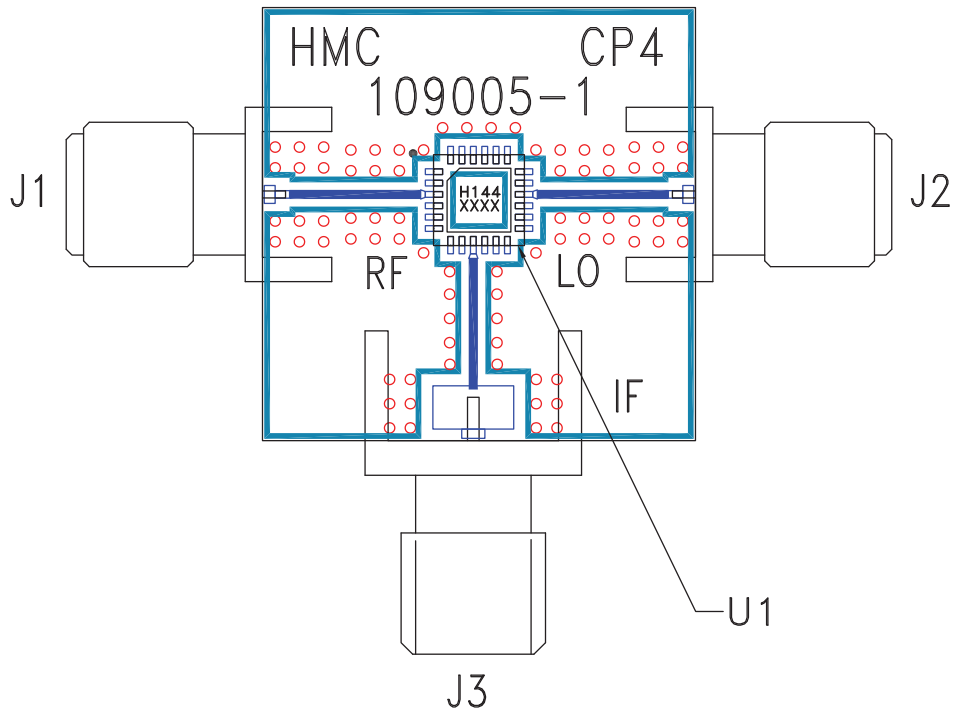

### List of Materials for Evaluation PCB 109010 [1]

Item	Description
J1 - J2	PCB Mount SMA RF Connector, SRI
J3	PCB Mount SMA Connector, Johnson
U1	HMC144LC4
PCB [2]	109005 Evaluation Board

[1] Reference this number when ordering complete evaluation PCB

[2] Circuit Board Material: Rogers 4350

The circuit board used in the final application should use RF circuit design techniques. Signal lines should have 50 ohm impedance while the package ground leads and exposed paddle should be connected directly to the ground plane similar to that shown. A sufficient number of via holes should be used to connect the top and bottom ground planes. The evaluation circuit board shown is available from Hittite upon request.