



GaAs MMIC SMT DOUBLE-BALANCED MIXER, 2.5 - 4 GHz

Typical Applications

The HMC170C8 is ideal for:

- Microwave Point-to-Point
- RADAR
- VSAT

Features

- Conversion Loss: 9. dB
- LO to RF Isolation: 45 dB
- Surface Mount
- Small Size, No DC Bias Required

Functional Diagram

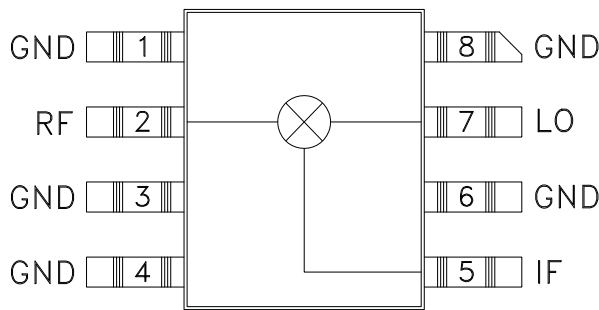

General Description

The HMC170C8 is a miniature double-balanced mixer in a non-hermetic ceramic surface mount package that can be used as an upconverter, downconverter or biphase modulator. The device is a passive diode/balun type mixer with high dynamic range. Noise figure is essentially equal to the conversion loss. The mixer can handle larger signal levels than most active mixers due to the high third order intercept. MMIC implementation provides exceptional balance in the circuit resulting in high LO/RF and LO/IF isolations and unit-to-unit consistency. This mixer has applications where small size and surface mount compatibility are important.

Electrical Specifications, $T_A = +25^\circ \text{C}$, LO Drive = +13 dBm

| Parameter | Min. | Typ. | Max. | Units |
|-------------------------------|-----------|------|------|-------|
| Frequency Range, RF & LO | 2.5 - 4.0 | | | GHz |
| Frequency Range, IF | DC - 2 | | | GHz |
| Conversion Loss | | 9 | 10 | dB |
| Noise Figure (SSB) | | 9 | 10 | dB |
| LO to RF Isolation | 40 | 45 | | dB |
| LO to IF Isolation | 32 | 36 | | dB |
| IP3 (Input) | 13 | 18 | | dBm |
| IP2 (Input) | 35 | 40 | | dBm |
| 1 dB Gain Compression (Input) | 7 | 10 | | dBm |

GaAs MMIC SMT DOUBLE-BALANCED MIXER, 2.5 - 4 GHz

Conversion Loss

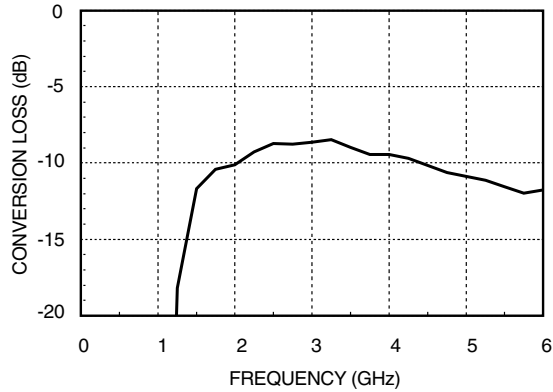

Isolation

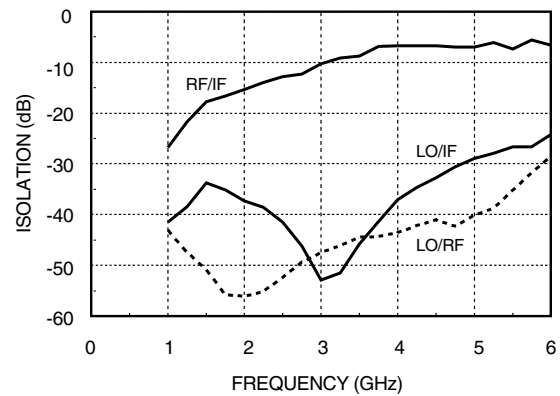

Conversion Loss vs. LO Drive

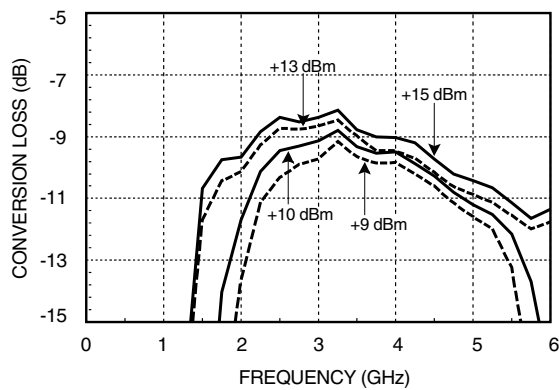

Isolation vs. LO Drive

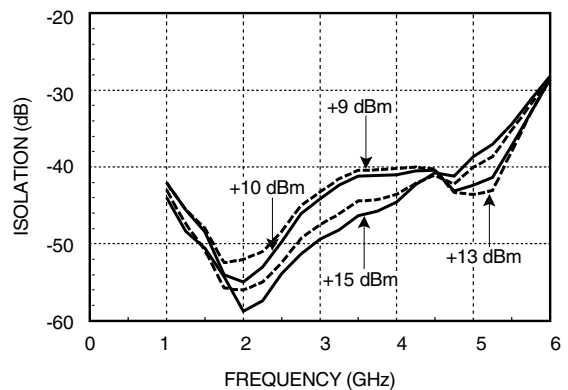

Return Loss

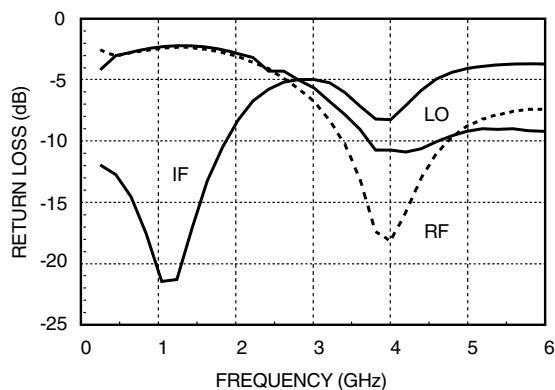

Distortion and 1dB Compression vs. LO Drive Level

| LO Drive (dBm) | Distortion | | 1 dB Compression (dBm) |
|----------------|------------|-----------|------------------------|
| | IP3 (dBm) | IP2 (dBm) | |
| +10 | 16 | 38 | 8 |
| +13 | 18 | 40 | 10 |
| +15 | 18 | 40 | 10 |

S - Parameters for the RF, LO, IF Ports are Available On-Line at www.hittite.com

For price, delivery, and to place orders, please contact Hittite Microwave Corporation:
20 Alpha Road, Chelmsford, MA 01824 Phone: 978-250-3343 Fax: 978-250-3373

www.BDTIC.com/Hittite/

Absolute Maximum Ratings

| | |
|-----------------------|----------------|
| RF / IF Input | +13 dBm |
| LO Drive | +27 dBm |
| Storage Temperature | -65 to +150 °C |
| Operating Temperature | -55 to +85 °C |



ELECTROSTATIC SENSITIVE DEVICE
OBSERVE HANDLING PRECAUTIONS

9

MIXERS - DBL-BAL - SMT

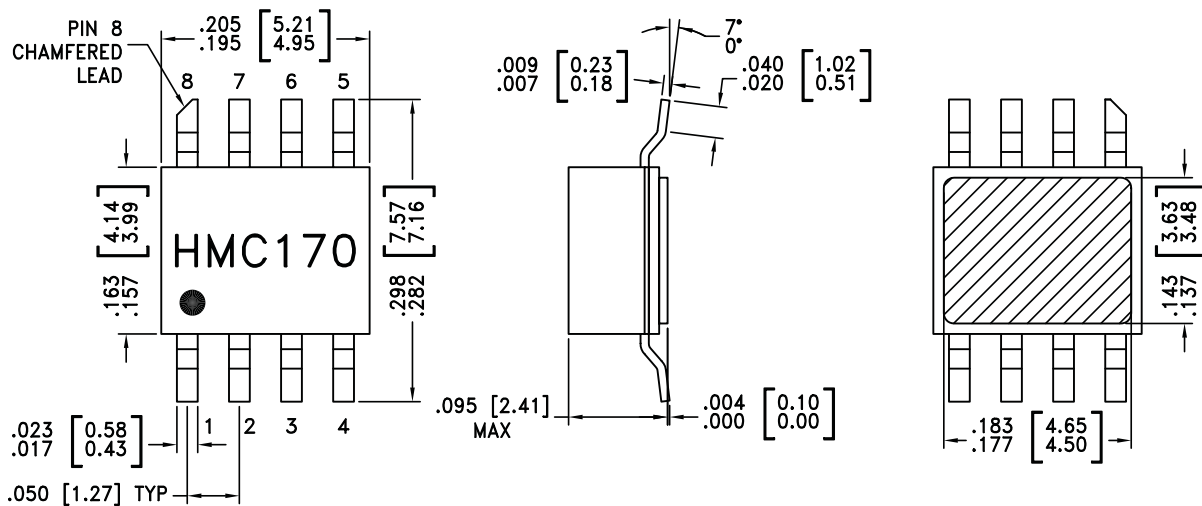
Outline Drawing

NOTES:

1. PACKAGE BODY MATERIAL: WHITE ALUMINA 92%
2. LEAD, PACKAGE BOTTOM MATERIAL: COPPER
3. PLATING: ELECTROLYTIC GOLD 100-200 MICROINCHES, OVER ELECTROLYTIC NICKEL 100-250 MICROINCHES.
4. DIMENSIONS ARE IN INCHES [MILLIMETERS].
5. PACKAGE LENGTH AND WIDTH DIMENSIONS DO NOT INCLUDE LID SEAL PROTRUSION .005 PER SIDE.
6. ALL GROUND LEADS AND GROUND PADDLE MUST BE SOLDERED TO PCB RF GROUND.

Evaluation PCB

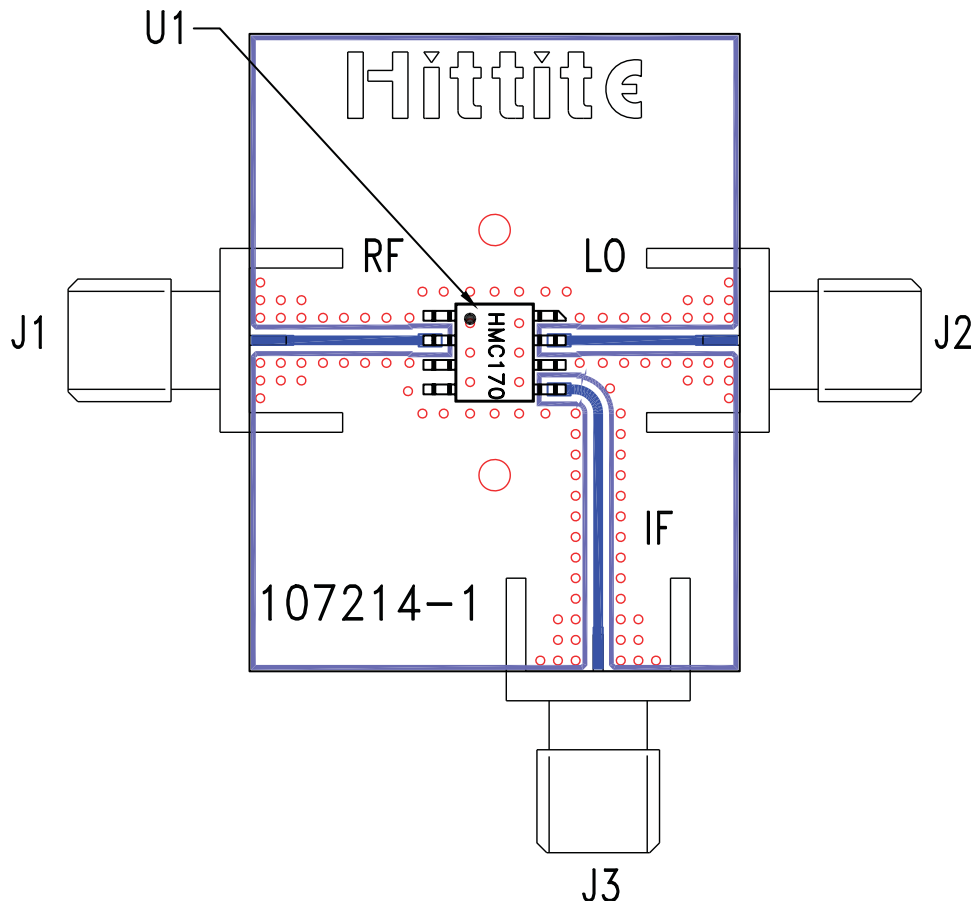

List of Materials for Evaluation PCB 102102 [1]

| Item | Description |
|---------|----------------------------|
| J1 - J3 | PCB Mount SMA RF Connector |
| U1 | HMC170C8 Mixer |
| PCB [2] | 107214 Evaluation Board |

[1] Reference this number when ordering complete evaluation PCB

[2] Circuit Board Material: Rogers 4350

The circuit board used in the final application should use RF circuit design techniques. Signal lines should have 50 ohm impedance while the package ground leads and exposed paddle should be connected directly to the ground plane similar to that shown. A sufficient number of via holes should be used to connect the top and bottom ground planes. The evaluation circuit board shown is available from Hittite upon request.