

Typical Applications

The HMC340ALP5 / HMC340ALP5E Dual Mixer is ideal for:

- Wireless Infrastructure
- Wireless Local Loop
- Image Reject Mixer
- I/Q Modulator
- SSB Modulator

Features

- Conversion Loss: 8.0 dB
- LO/RF Isolation: 45 dB
- LO/IF Isolation: 33 dB
- Input IP3: +20 dBm
- Conversion Gain Balance: 0.1 dB
- 32 Lead 5x5mm SMT Package: 25mm²

Functional Diagram

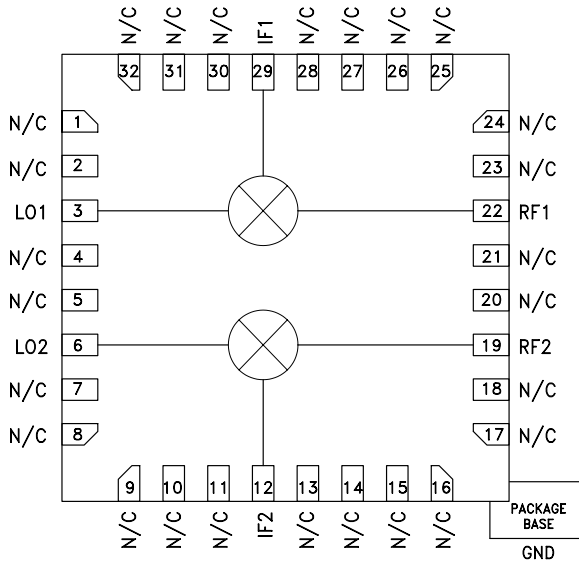

General Description

The HMC340ALP5(E) is a double balanced dual mixer covering 1.7 - 4.5 GHz RF/LO range. This passive MMIC mixer is constructed of GaAs Schottky diodes and on-chip baluns. The device can be used as an upconverter, downconverter, bi-phase (de)modulator, or phase comparator. The mixer symmetry of the HMC340ALP5(E) make it ideal for combining with external hybrids to implement a single sideband upconverter or image reject downconverter assembly. The consistent MMIC performance will improve system operation and assure regulatory compliance. A RoHS compliant, leadless 5x5 mm QFN surface mount package (LP5) houses the dual MMIC mixer IC.

Electrical Specifications, $T_A = +25^\circ C$, As a Function of LO Drive

Parameter	LO = +13 dBm IF = 100 MHz						Units
	Min.	Typ.	Max.	Min.	Typ.	Max.	
Frequency Range, RF & LO	1.7 - 4.5			3.4 - 3.8			GHz
Frequency Range, IF	DC - 1.5			DC - 1.5			GHz
Conversion Loss		8	10		8	10	dB
Conversion Gain Amplitude Balance		0.10	0.25		0.10	0.25	dB
Noise Figure (SSB)		8	10		8	10	dB
LO to RF Isolation	30	45		40	47		dB
LO to IF Isolation	25	33		33	38		dB
IP3 (Input)		20			23		dBm
1 dB Gain Compression (Input)		12			13		dBm

* Unless otherwise noted, all measurements performed as single channel downconverter.



HMC340ALP5 / 340ALP5E

GaAs MMIC SMT DOUBLE-BALANCED DUAL MIXER, 1.7 - 4.5 GHz

Single Channel: Conversion Gain vs. Temperature @ LO = +13 dBm

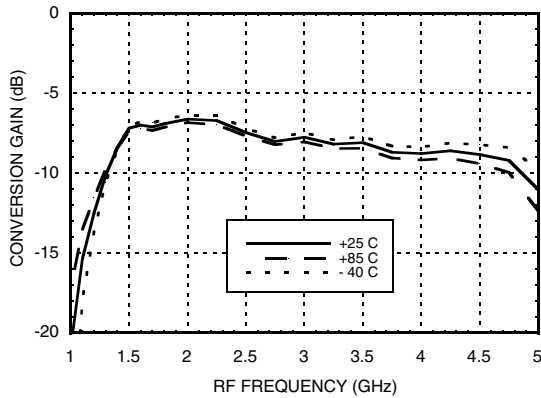

Single Channel: Isolation @ LO = +13 dBm

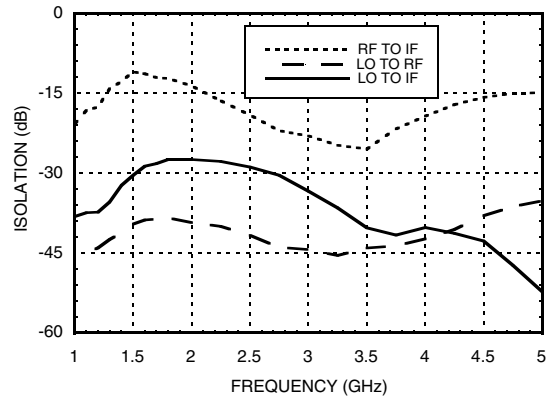

Single Channel: Conversion Gain vs. LO Drive

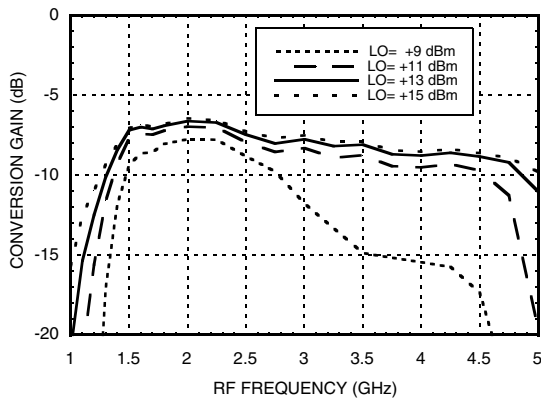

Single Channel: Return Loss @ LO = +13 dBm

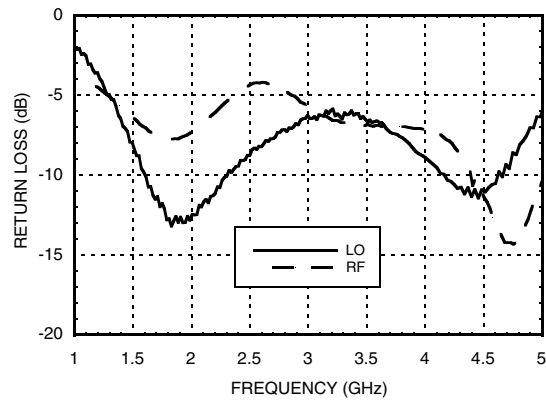

Single Channel: IF Bandwidth @ LO = +13 dBm

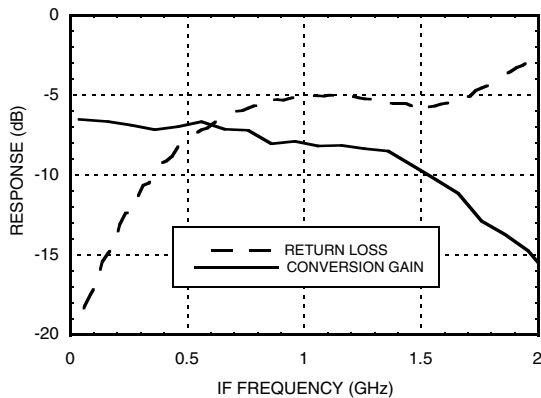

Single Channel: Input P1dB vs. Temperature @ LO = +13 dBm

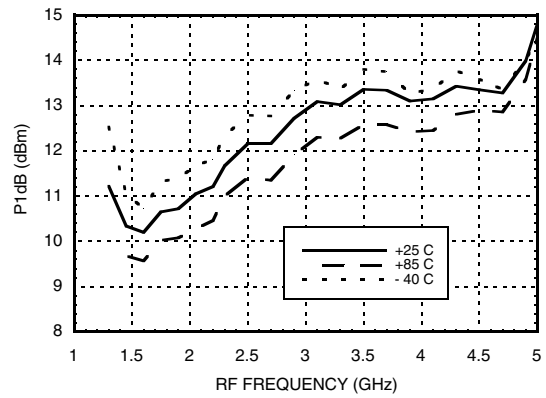

10

MIXERS - SINGLE & DOUBLE BALANCED - SMT



MICROWAVE CORPORATION v00.0710



HMC340ALP5 / 340ALP5E

GaAs MMIC SMT DOUBLE-BALANCED DUAL MIXER, 1.7 - 4.5 GHz

Single Channel: Input IP3 vs. LO Drive

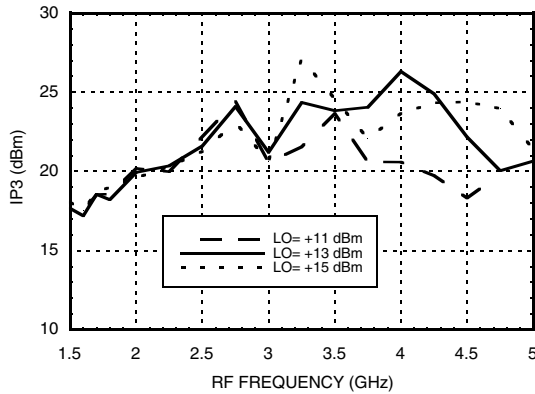

Single Channel: Input IP3 vs. Temperature @ LO = +13 dBm

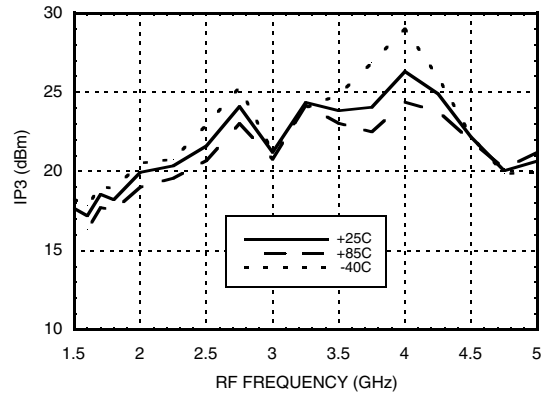

Single Channel: Input IP2 vs. LO Drive

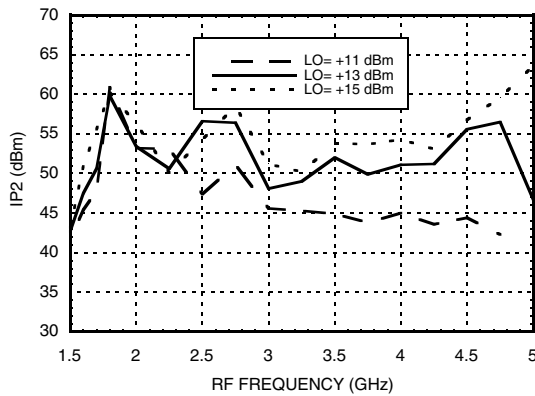

Single Channel: Input IP2 vs. Temperature @ LO = +13 dBm

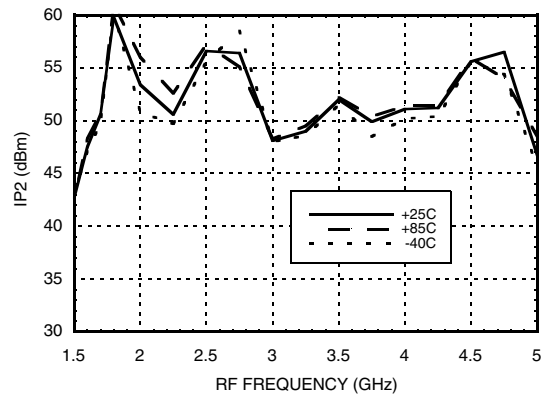

Single Channel: Upconverter Conversion Gain vs. LO Drive

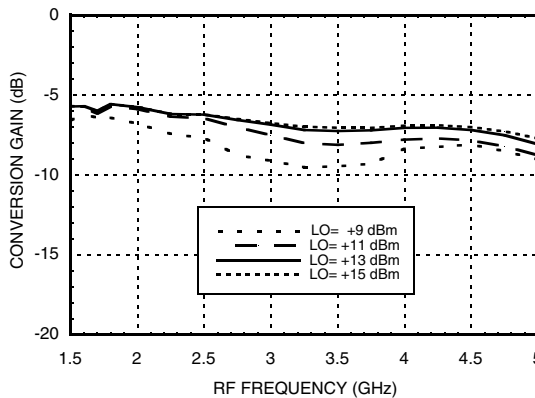

Single Channel: Upconverter IP3 vs. LO Drive

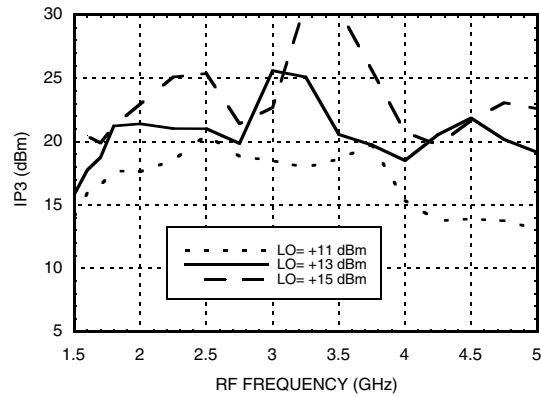

For price, delivery and to place orders: Hittite Microwave Corporation, 20 Alpha Road, Chelmsford, MA 01824

Phone: 978-250-3343 Fax: 978-250-3373 Order On-line at www.hittite.com

Application Support Phone: 978-250-3343 or apps@hittite.com

www.BDTIC.com/Hittite/



MICROWAVE CORPORATION v00.0710



HMC340ALP5 / 340ALP5E

GaAs MMIC SMT DOUBLE-BALANCED DUAL MIXER, 1.7 - 4.5 GHz

**Dual Channel:
Conversion Gain Amplitude Balance**

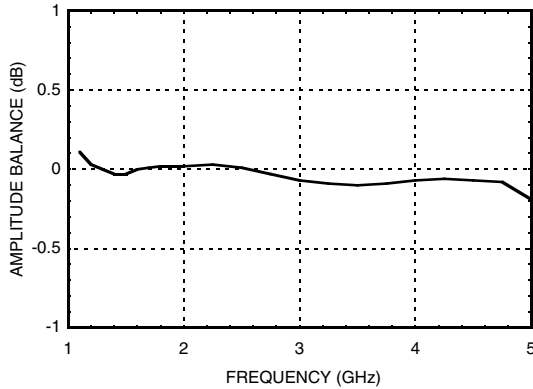

**Dual Channel:
Channel to Channel Isolation**

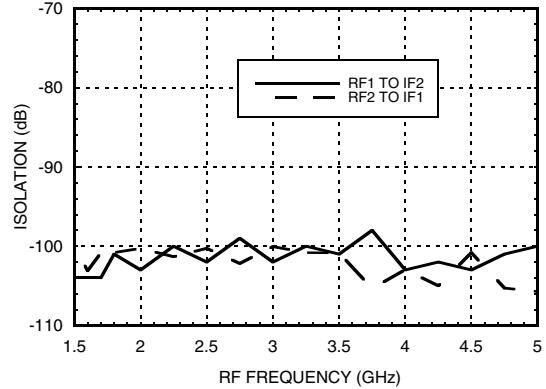

**Dual Channel:
LO1 to LO2 Isolation**

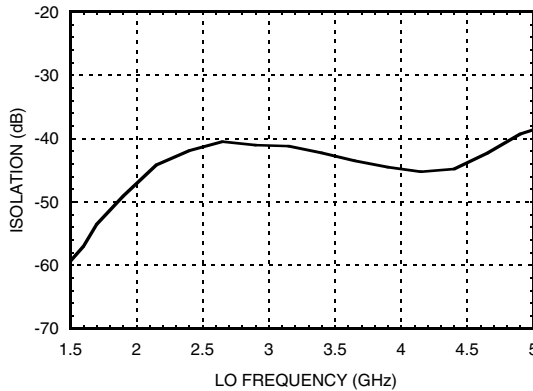

**Dual Channel:
RF1 to RF2 Isolation**

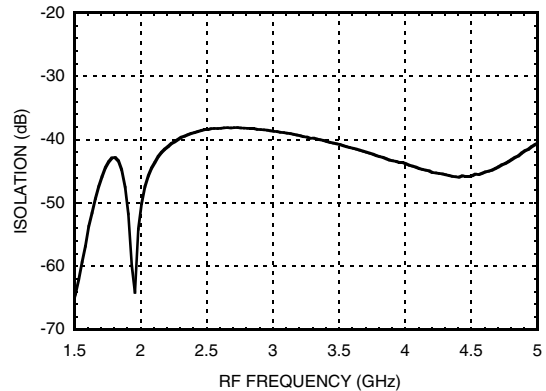

**Dual Channel:
IF1 to IF2 Isolation**

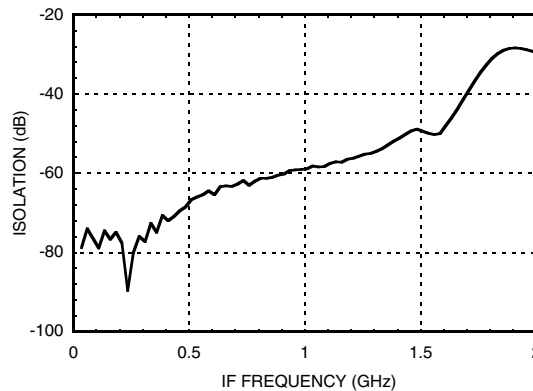

Harmonics of LO

LO Freq. (GHz)	nLO Spur at RF Port			
	1	2	3	4
1.5	39	29	57	68
2.0	40	26	63	68
2.5	43	28	41	63
3.0	44	38	63	67
3.5	44	48	66	70
4.0	42	49	63	67
4.5	38	49	63	83
5.0	36	53	59	89

LO = +13 dBm
Values in dBc below input LO level measured at RF Port.

For price, delivery and to place orders: Hittite Microwave Corporation, 20 Alpha Road, Chelmsford, MA 01824
Phone: 978-250-3343 Fax: 978-250-3373 Order On-line at www.hittite.com

www.BDTIC.com/Hittite/

10

MIXERS - SINGLE & DOUBLE BALANCED - SMT

Absolute Maximum Ratings

RF / IF Input	+13 dBm
LO Drive	+27 dBm
Channel Temperature	150°C
Continuous Pdiss (T = 85°C) (derate 16.55 mW/°C above 85°C)	1.07 W
Thermal Resistance (R _{TH}) (junction to package base)	60.4 °C/W
Storage Temperature	-65 to +150 °C
Operating Temperature	-40 to +85 deg °C

MxN Spurious Outputs

mRF	nLO				
	0	1	2	3	4
0	xx	11	20	36	45
1	19	0	26	37	41
2	71	67	67	68	71
3	86	86	85	78	78
4	86	86	86	86	86

RF = 3.5 GHz @ -10 dBm
LO = 3.6 GHz @ +13 dBm
All values in dBc below IF power level



**ELECTROSTATIC SENSITIVE DEVICE
OBSERVE HANDLING PRECAUTIONS**

Outline Drawing

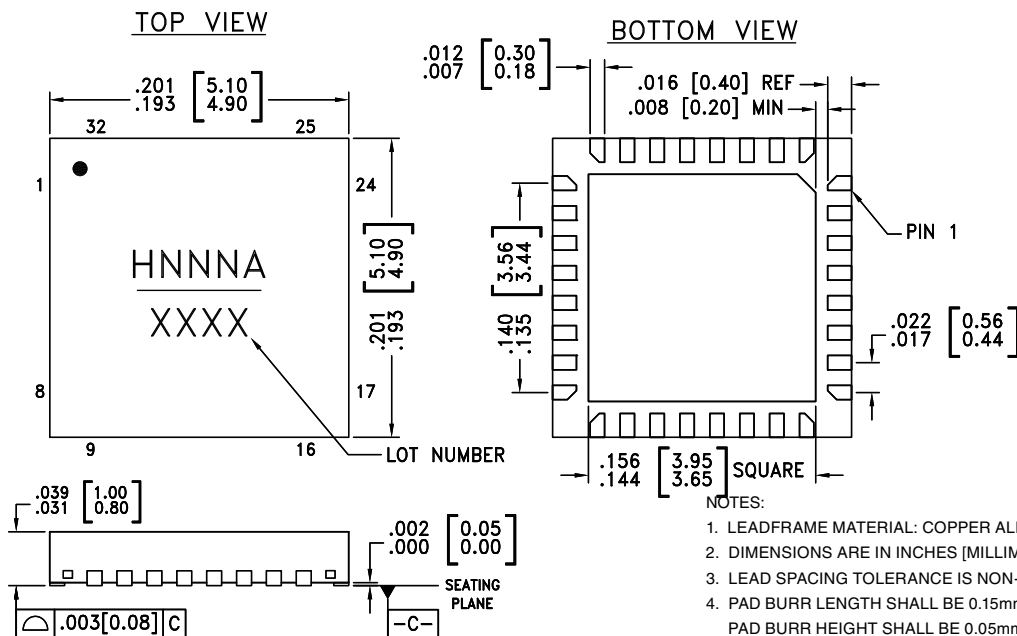

Package Information



Part Number	Package Body Material	Lead Finish	MSL Rating	Package Marking ^[3]
HMC340ALP5	Low Stress Injection Molded Plastic	Sn/Pb Solder	MSL1 ^[1]	H340A XXXX
HMC340ALP5E	RoHS-compliant Low Stress Injection Molded Plastic	100% matte Sn	MSL1 ^[2]	H340A XXXX

[1] Max peak reflow temperature of 235 °C

[2] Max peak reflow temperature of 260 °C

[3] 4-Digit lot number XXXX

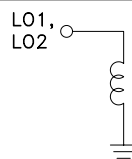
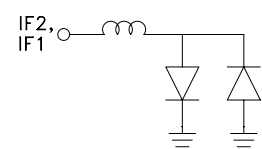
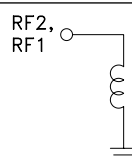
Pin Descriptions

Pin Number	Function	Description	Interface Schematic
1, 2, 4, 5, 7-11, 13-18, 20, 21, 23-28, 30-32	N/C	No Connection. These pins may be connected to RF ground without affecting performance.	
3, 6	LO1, LO2	LO Port: This pin is DC coupled and matched to 50 Ohms.	
12, 29	IF2, IF1	IF Port: This pin is DC coupled. For applications not requiring operation to DC, this port should be DC blocked externally using a series capacitor whose values has been chosen to pass the necessary IF frequency range. For operation to DC, this pin must not source/sink more than 4mA of current or die non-function and possible die failure will result.	
19, 22	RF2, RF1	RF Port: This pin is DC coupled and matched to 50 Ohms.	
Package Bottom	GND	Package bottom must be connect to RF/DC ground.	



Application Circuit for use as an I/Q Modulator

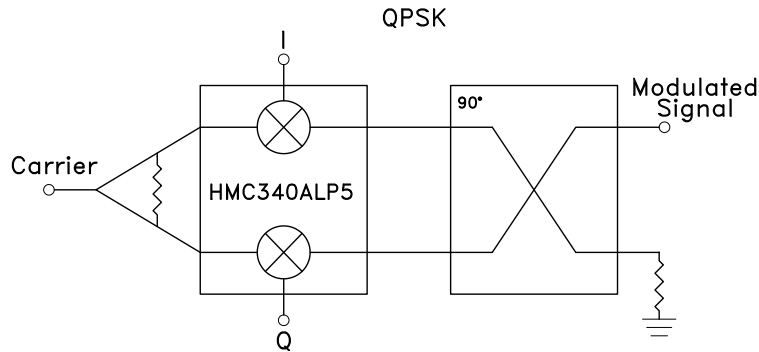

Application Circuit for use as an IRM Mixer

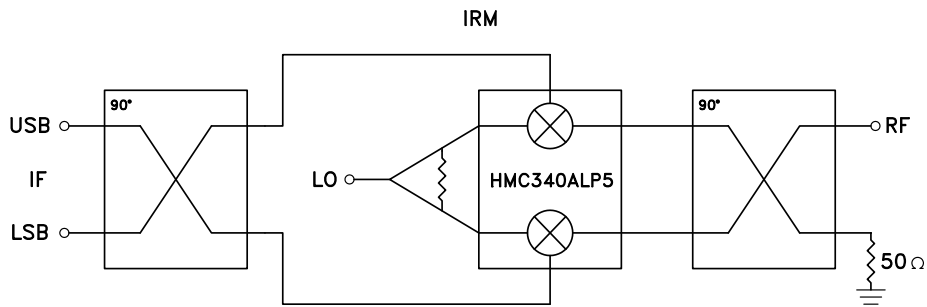

Evaluation PCB

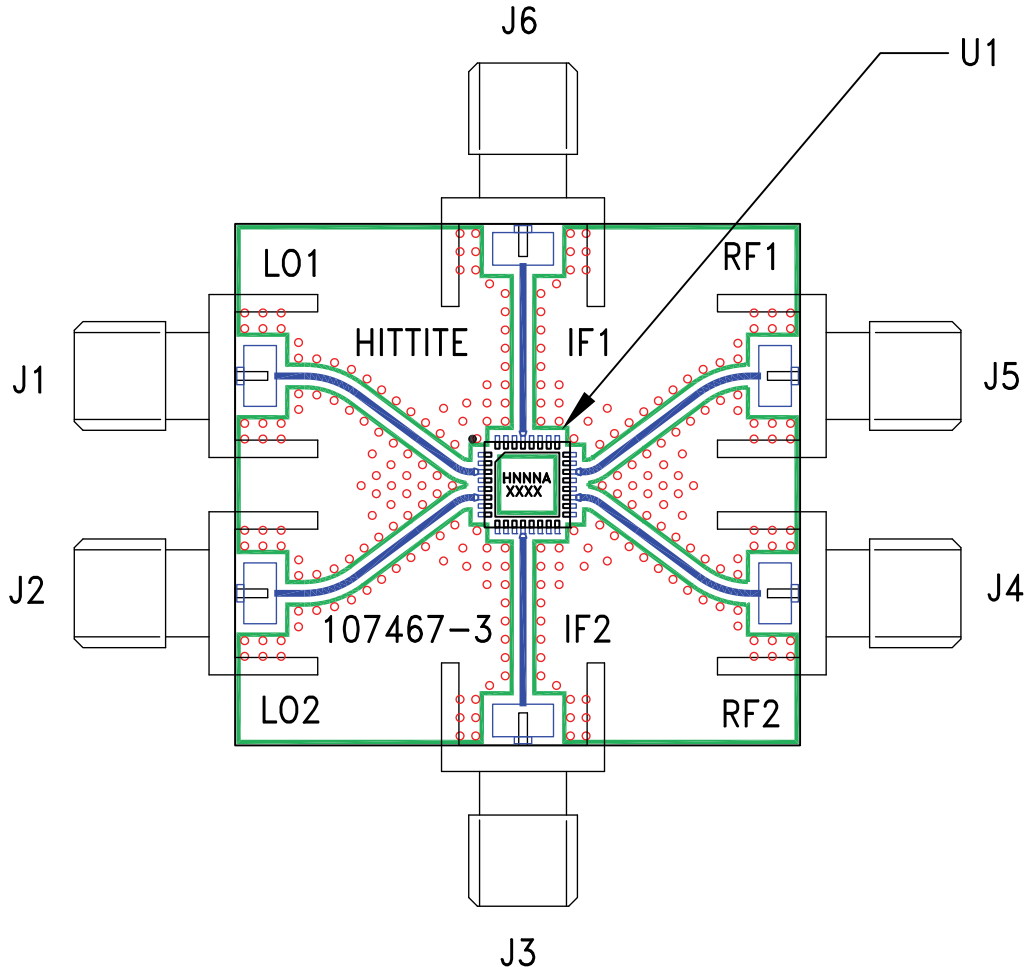

List of Materials for Evaluation PCB 107482 [1]

Item	Description
J1 - J6	PCB Mount SMA RF Connector
U1	HMC340ALP5(E) Dual Mixer
PCB [2]	107467 Evaluation Board

[1] Reference this number when ordering complete evaluation PCB

[2] Circuit Board Material: Rogers 4350

The circuit board used in the application should use RF circuit design techniques. Signal lines should have 50 Ohm impedance while the package ground leads and exposed paddle should be connected directly to the ground plane similar to that shown. A sufficient number of via holes should be used to connect the top and bottom ground planes. The evaluation circuit board shown is available from Hittite upon request.