



CELLULAR HIGH IP3 RFIC DOWNCONVERTER, 0.8 - 1.0 GHz

Typical Applications

The HMC377QS16G / HMC377QS16GE is ideal for:

- GSM & CDMA Infrastructure
- GPRS & EDGE Infrastructure
- Wireless Data/CDPD

Features

- +15 dBm Input IP3, +29 dBm Output IP3
- Low LO Drive: -5 dBm LO
- Conversion Gain: 14 dB
- Noise Figure: 11 dB
- Positive Supply: +5V @ 135 mA

Functional Diagram

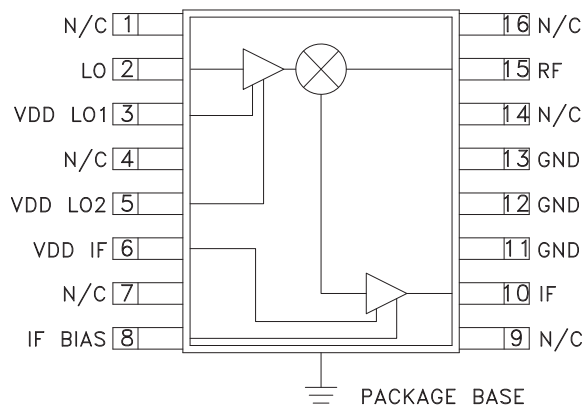

General Description

The HMC377QS16G & HMC377QS16GE are linear downconverter receiver ICs suitable for cellular infrastructure applications from 0.8 - 1.0 GHz. An integrated mixer coupled with a high dynamic range IF amplifier achieves an input intercept point (IP3) of +15 dBm, and an input P1dB of +3.5 dBm. The converter provides a gain of 13.5 dB and only 11 dB typical single side band noise figure. The IC operates from a positive +5V rail consuming 135 mA of current while requiring only -5 dBm LO drive. The design requires no external baluns. The mixer supports IF frequencies between 50 MHz and 250 MHz.

Electrical Specifications, $T_A = +25^\circ C$, LO = -5 dBm, IF = 70 MHz, Vdd = 5V

| Parameter | Min. | Typ. | Max. | Units |
|--|-------------|---------|------|-------|
| Frequency Range, RF | 0.8 - 1.0 | | | GHz |
| Frequency Range, LO | 0.55 - 1.15 | | | GHz |
| Frequency Range, IF * | 50 - 250 | | | MHz |
| Conversion Gain | 11 | 14 | | dB |
| Noise Figure (SSB) | | 11 | | dB |
| LO to RF Isolation | 23 | 28 | | dB |
| LO to IF Isolation | 63 | 70 - 75 | | dB |
| RF to IF Isolation | 83 | 90 - 95 | | dB |
| IP3 (Input) | 12 | 15 | | dBm |
| 1 dB Compression (Input) | +0.5 | +3.5 | | dBm |
| LO Input Drive Level (Typical) | -10 to 0 | | | dBm |
| Supply Current (I _{dd} for IF + LO) | | 135 | | mA |

* IF matching must be tuned for optimal results. See application circuit herein.

For price, delivery, and to place orders, please contact Hittite Microwave Corporation:
20 Alpha Road, Chelmsford, MA 01824 Phone: 978-250-3343 Fax: 978-250-3373

Order On-Line at www.hittite.com
www.BDTC.com/Hittite/

CELLULAR HIGH IP3 RFIC DOWNCONVERTER, 0.8 - 1.0 GHz



**Conversion Gain
vs. Temperature @ LO= -5 dBm**

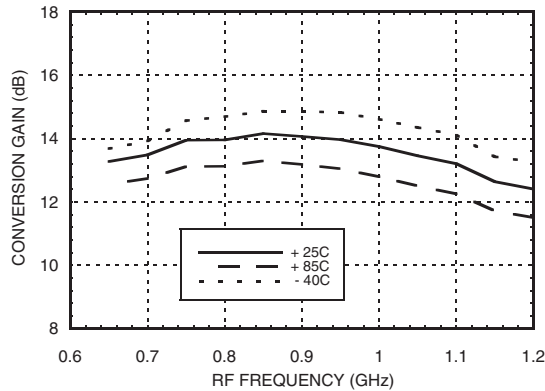

Isolation @ LO= -5 dBm

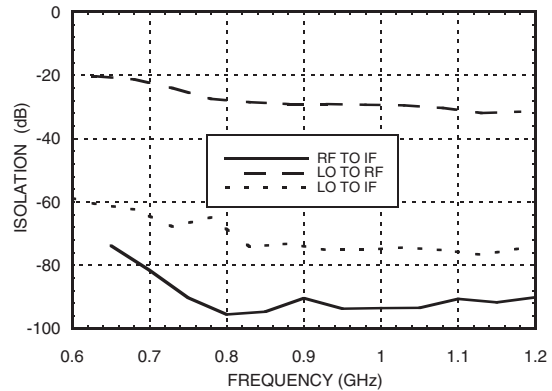

Conversion Gain vs. LO Drive

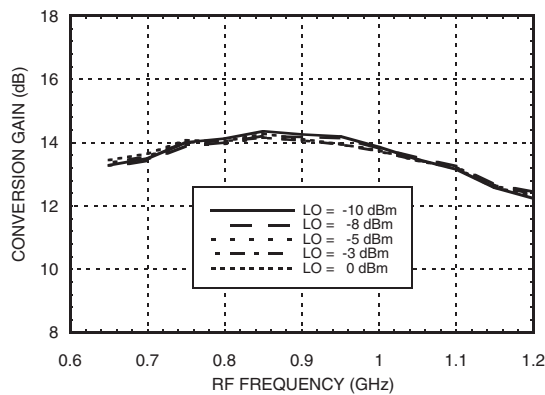

Return Loss @ LO= -5 dBm

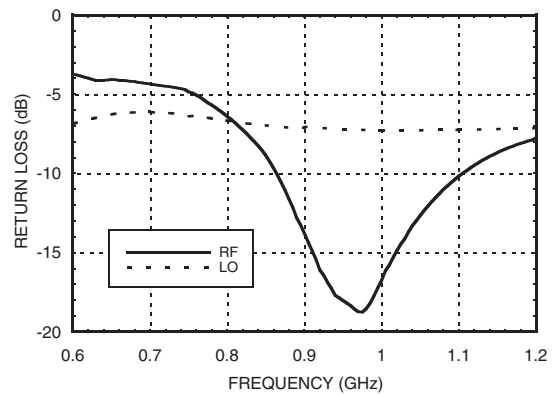

Conversion Gain vs. Vdd @ LO= -5 dBm

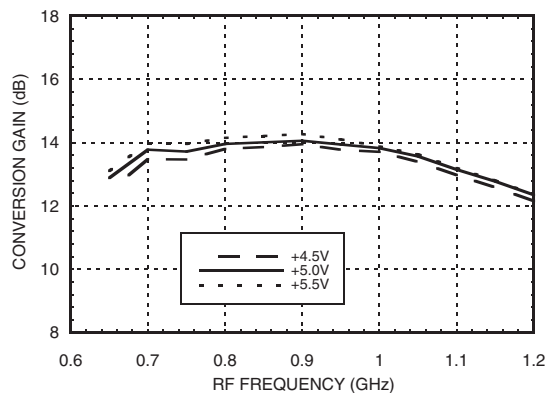

**CELLULAR HIGH IP3 RFIC
DOWNCONVERTER, 0.8 - 1.0 GHz**



**Input P1dB vs.
Temperature @ LO= -5 dBm**

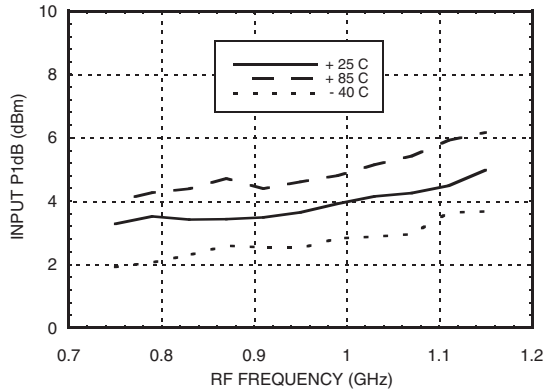

Input P1dB vs. Vdd @ LO= -5 dBm

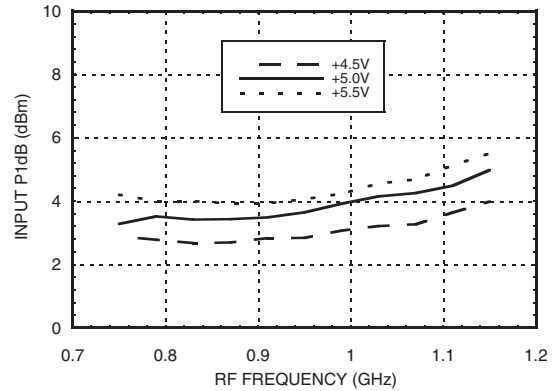

**Input and Output
IP3 vs. Temperature @ LO= -5 dBm**

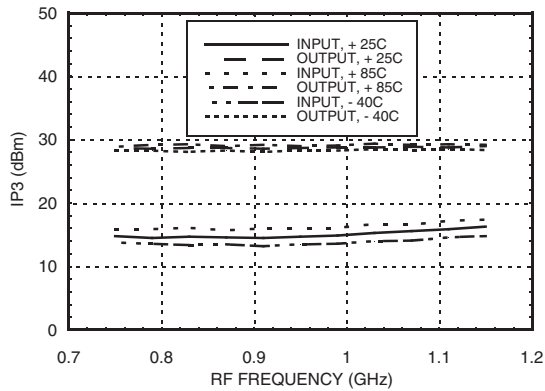

Input and Output IP3 vs. LO Drive

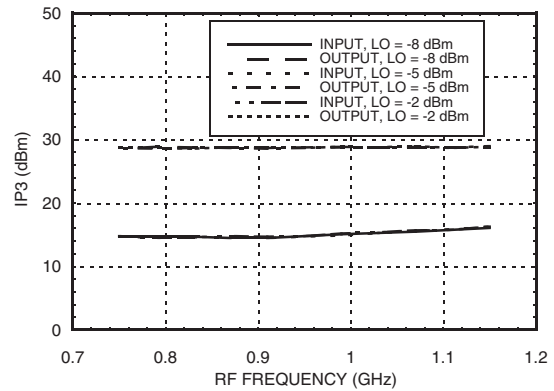

**Input and Output
IP3 vs. Vdd @ LO= -5 dBm**

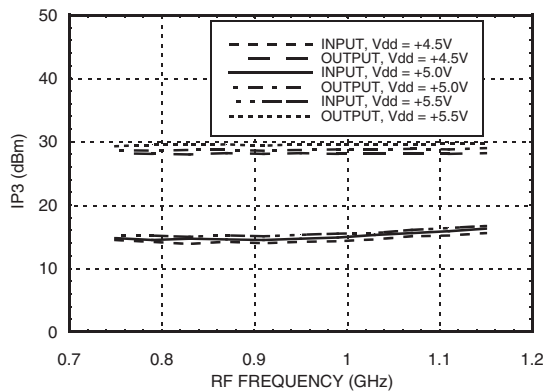



CELLULAR HIGH IP3 RFIC DOWNCONVERTER, 0.8 - 1.0 GHz

**Noise Figure vs. Temperature,
Swept LO, Fixed IF= 70 MHz**

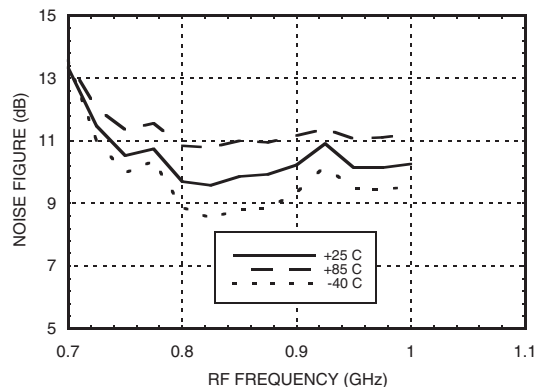

Noise Figure Swept IF, Fixed LO

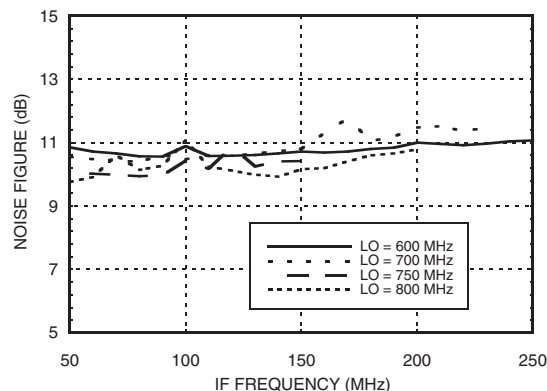

**IF Return Loss
@ Various Tuned IF Frequencies**

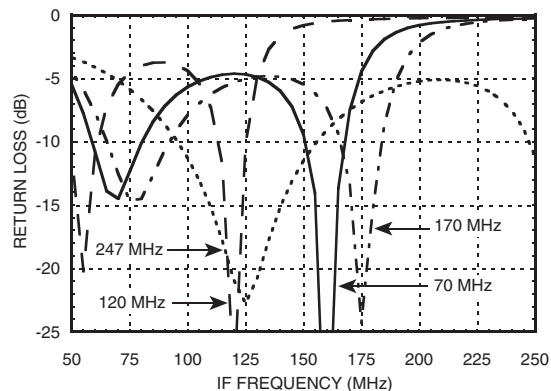

**IF Bandwidth
@ Various Tuned IF Frequencies**

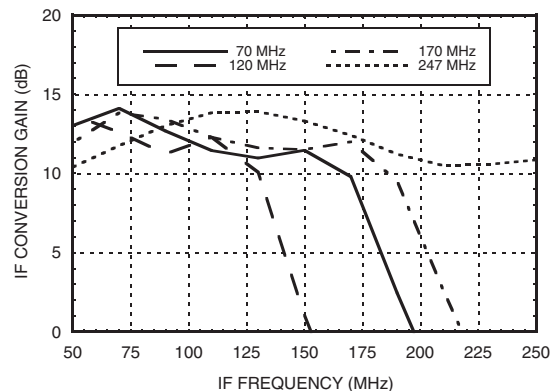

MxN Spurious @ IF Port

| mRF | nLO | | | | |
|-----|-----|----|----|----|----|
| | 0 | 1 | 2 | 3 | 4 |
| 0 | xx | 79 | 95 | 93 | 94 |
| 1 | 94 | 0 | 95 | 95 | 95 |
| 2 | 95 | 95 | 44 | 95 | 95 |
| 3 | 95 | 95 | 95 | 84 | 95 |
| 4 | 94 | 94 | 94 | 95 | 94 |

RF Freq.= 0.9 GHz @ -10 dBm
LO Freq.= 0.83 GHz @ -5 dBm
All values in dBc relative to the IF power level.

Harmonics of LO

| LO Freq. (GHz) | nLO Spur @ RF Port | | | |
|----------------|--------------------|----|----|----|
| | 1 | 2 | 3 | 4 |
| 0.7 | 22 | 9 | 34 | 26 |
| 0.75 | 26 | 11 | 31 | 30 |
| 0.8 | 28 | 13 | 32 | 33 |
| 0.85 | 29 | 15 | 32 | 36 |
| 0.9 | 29 | 16 | 33 | 49 |
| 0.95 | 29 | 17 | 34 | 45 |

LO= -5 dBm
Values in dBc below input LO level measured at RF port.

* Refer to HMC420QS16 Application Circuit herein for IF port tuning information.

CELLULAR HIGH IP3 RFIC DOWNCONVERTER, 0.8 - 1.0 GHz

Absolute Maximum Ratings

| | |
|---|-------------------|
| RF / IF Input (Vdd= +5V) | +13 dBm |
| LO Drive (Vdd= +5V) | +15 dBm |
| Vdd (LO or IF) | +7 Vdc |
| Channel Temperature | 150°C |
| Continuous Pdiss (T = 85°C) (derate 17.4 mW/°C above 85°C) | 0.881 W |
| Thermal Resistance (R _{TH}) (junction to lead) | 57.3 °C/W |
| Storage Temperature | -65 to +150 °C |
| Operating Temperature | -40 to +85 deg °C |

Typical Supply Current vs. Vdd

| Vdd (Vdc) (LO & IF) | Idd (mA) |
|---------------------|----------|
| 4.5 | 115 |
| 5.0 | 135 |
| 5.5 | 155 |

Downconverter will operate over above supply range.



ELECTROSTATIC SENSITIVE DEVICE
OBSERVE HANDLING PRECAUTIONS

Outline Drawing

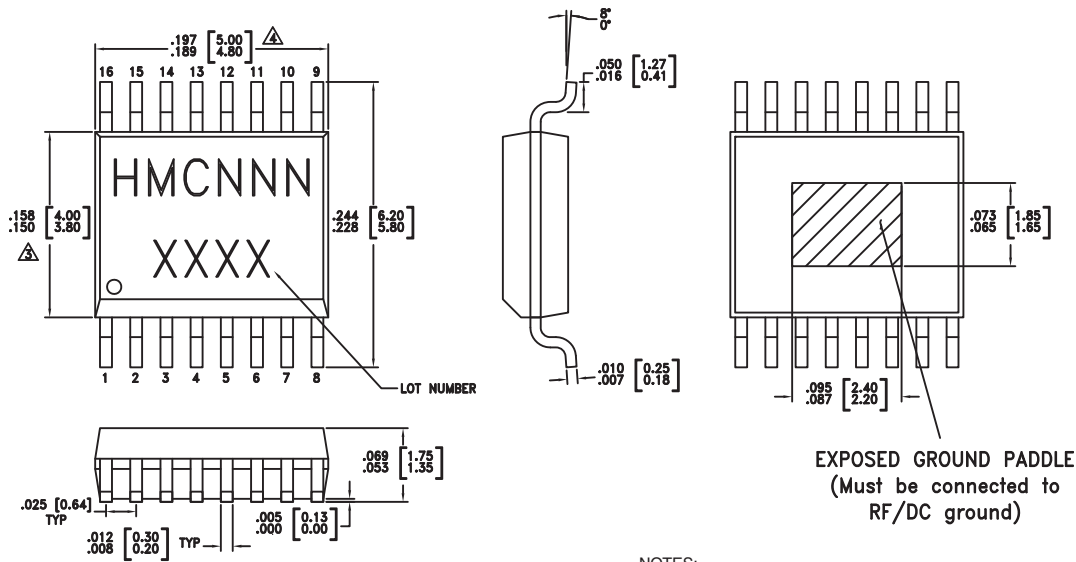

NOTES:

- LEADFRAME MATERIAL: COPPER ALLOY
- DIMENSIONS ARE IN INCHES [MILLIMETERS].
- DIMENSION DOES NOT INCLUDE MOLDFLASH OF 0.15mm PER SIDE.
- DIMENSION DOES NOT INCLUDE MOLDFLASH OF 0.25mm PER SIDE.
- ALL GROUND LEADS AND GROUND PADDLE MUST BE SOLDERED TO PCB RF GROUND.

Package Information

| Part Number | Package Body Material | Lead Finish | MSL Rating | Package Marking ^[3] |
|--------------|--|---------------|---------------------|--------------------------------|
| HMC377QS16G | Low Stress Injection Molded Plastic | Sn/Pb Solder | MSL1 ^[1] | HMC377 XXXX |
| HMC377QS16GE | RoHS-compliant Low Stress Injection Molded Plastic | 100% matte Sn | MSL1 ^[2] | HMC377 XXXX |

[1] Max peak reflow temperature of 235 °C

[2] Max peak reflow temperature of 260 °C





[3] 4-Digit lot number XXXX

For price, delivery, and to place orders, please contact Hittite Microwave Corporation:
20 Alpha Road, Chelmsford, MA 01824 Phone: 978-250-3343 Fax: 978-250-3373

Order On-Line at www.hittite.com
www.BDTC.com/Hittite/

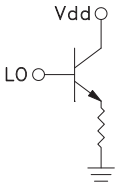
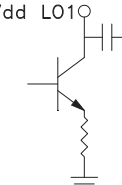
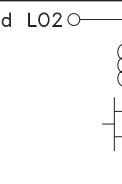

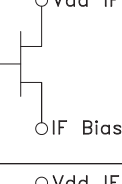
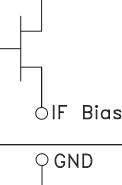
Pin Descriptions

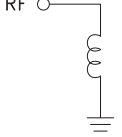
| Pin Number | Function | Description | Interface Schematic |
|-----------------------|----------|--|---|
| 1, 4, 7, 9, 14, 16 | N/C | No Connection. These pins may be connected to RF ground. Performance will not be affected. | |
| 2 | LO | This pin is DC coupled and matched to 50 Ohms from 0.8 - 1.0 GHz. An external series capacitor (100 pF) (C9) is required. |  |
| 3 | Vdd LO 1 | Power Supply for the LO amplifier, An external 56 nH series inductor (L3) with 22 Ohm series bias resistor (R2) and an RF bypass capacitor (C8) are required. |  |
| 5 | Vdd LO 2 | Power supply for the LO amplifier. One external RF bypass capacitor (10,000 pF) (C3) is required. |  |
| 6 | Vdd IF | Bias voltage for IF amplifier. One external RF bypass capacitor (10,000 pF) (C2) is required. |  |
| 8 | IF Bias | DC bias setting for IF amplifier. (C1, R1) |  |
| 10 | IF | Output of IF and bias port for amplifier. A pull up inductor (L1), output matching network (C5, C6, C7, L2, L4), and 10,000 pF bypass capacitor (C4) are required. |  |
| 11, 12, 13 | GND | Pin must connect to RF ground. Backside of package has exposed metal ground slug that must also be connected to RF/DC ground. |  |
| 15 | RF | This pin is DC coupled and matched to 50 Ohms from 0.8 - 1.0 GHz. |  |

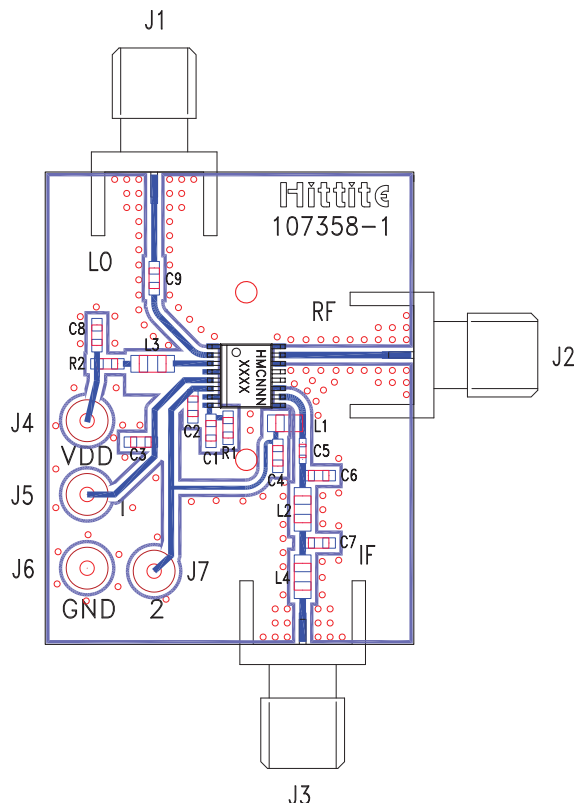
Evaluation PCB

List of Materials for Evaluation PCB 107360 [1]

| Item | Description |
|----------------|-----------------------------------|
| J1, J2, J3 | PCB Mount SMA RF Connector |
| J4, J5, J6, J7 | DC Pins |
| C1 | 1000 pF Chip Capacitor, 0603 Pkg. |
| C2, C3, C4, C8 | 0.01µF Chip Capacitor, 0603 Pkg. |
| C5 | 82 pF Chip Capacitor, 0402 Pkg. |
| C6, C7 [3] | 33 pF Chip Capacitor, 0603 Pkg. |
| C9 | 100 pF Chip Capacitor, 0602 Pkg. |
| L1 | 150 nH Chip Inductor, 0805 Pkg. |
| L2, L4 | 68 nH Chip Inductor, 0805 Pkg. |
| L3 | 56 nH Inductor, 0805 Pkg. |
| R1 | 3.3 Ohm Resistor, 0603 |
| R2 | 22 Ohm Resistor, 0603 Pkg. |
| U1 | HMC377QS16G / HMC377QS16GE Mixer |
| PCB [2] | 107358 Evaluation Board |

[1] Reference this number when ordering complete evaluation PCB

[2] Circuit Board Material: Rogers 4350

[3] For 70 MHz IF. See Application Circuit for alternate IF frequency tuning.

The circuit board used in the final application should use RF circuit design techniques. Signal lines should have 50 ohm impedance while the package ground leads should be connected directly to the ground plane similar to that shown. A sufficient number of via holes should be used to connect the top and bottom ground planes. The evaluation circuit board shown is available from Hittite upon request.

For price, delivery, and to place orders, please contact Hittite Microwave Corporation:
20 Alpha Road, Chelmsford, MA 01824 Phone: 978-250-3343 Fax: 978-250-3373

Order Online at www.hittite.com
www.BDHC.com/Hittite/



CELLULAR HIGH IP3 RFIC DOWNCONVERTER, 0.8 - 1.0 GHz

Application Circuit

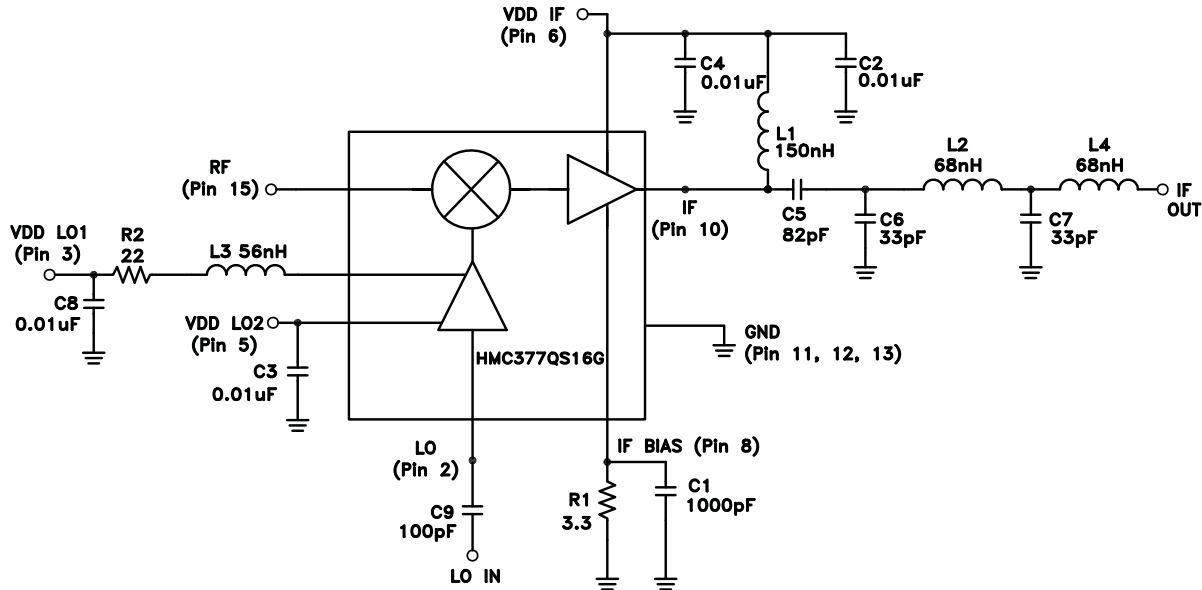

Note: Pins 3, 5 and 6 may be connected to a common Vdd Supply.

Selection of C6 & C7 For Various Tuned IF Frequencies

| IF | C6, C7 |
|---------|--------|
| 70 MHz | 150 pF |
| 120 MHz | 56 pF |
| 170 MHz | 27 pF |
| 247 MHz | 12 pF |