



Typical Applications

The HMC557LC4 is ideal for:

- WiMAX & Fixed Wireless
- Point-to-Point Radios
- Point-to-Multit-Point Radios
- Test Equipment & Sensors
- Military End-Use

Features

- Passive Double Balanced Topology
- Wide IF Bandwidth: DC - 3 GHz
- High LO/RF Isolation: 48 dB
- Low Conversion Loss: 7 dB
- 24 Lead Ceramic 4x4mm SMT Package: 16mm²

Functional Diagram

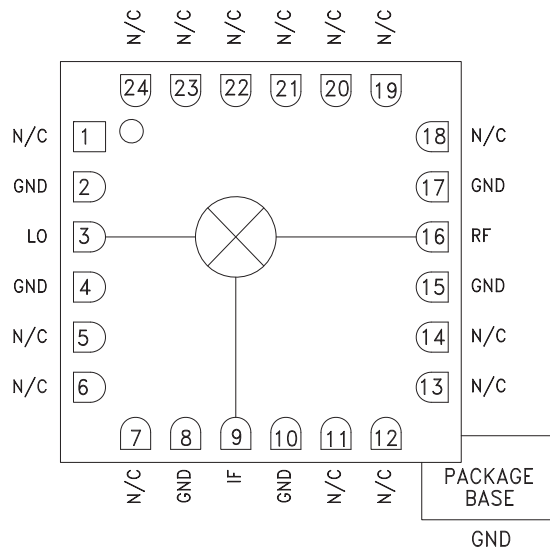

General Description

The HMC557LC4 is a general purpose double balanced mixer in a leadless RoHS compliant SMT package that can be used as an upconverter or downconverter between 2.5 and 7 GHz. This mixer is fabricated in a GaAs MESFET process, and requires no external components or matching circuitry. The HMC557LC4 provides excellent LO to RF and LO to IF isolation due to optimized balun structures and operates with LO drive levels as low as +9 dBm. The RoHS compliant HMC557LC4 eliminates the need for wire bonding, and is compatible with high volume surface mount manufacturing techniques.

Electrical Specifications, $T_A = +25^\circ \text{C}$, $IF = 100 \text{ MHz}$, $LO = +15 \text{ dBm}^*$

Parameter	Min.	Typ.	Max.	Min.	Typ.	Max.	Units
Frequency Range, RF & LO	2.5 - 5.0			5.0 - 7.0			GHz
Frequency Range, IF	DC - 3			DC - 3			GHz
Conversion Loss		7	9.5		8.5	10.5	dB
Noise Figure (SSB)		7	9.5		8.5	10.5	dB
LO to RF Isolation	40	48		40	48		dB
LO to IF Isolation	26	32		25	30		dB
RF to IF Isolation	12	18		20	25		dB
IP3 (Input)		17			22		dBm
IP2 (Input)		50			50		dBm
1 dB Gain Compression (Input)		10			13		dBm

*Unless otherwise noted, all measurements performed as downconverter, $IF = 100 \text{ MHz}$.

For price, delivery, and to place orders, please contact Hittite Microwave Corporation:
20 Alpha Road, Chelmsford, MA 01824 Phone: 978-250-3343 Fax: 978-250-3373

Order On-Line at www.hittite.com
www.BDTC.com/Hittite/



Conversion Gain vs. Temperature
@ LO = +15 dBm

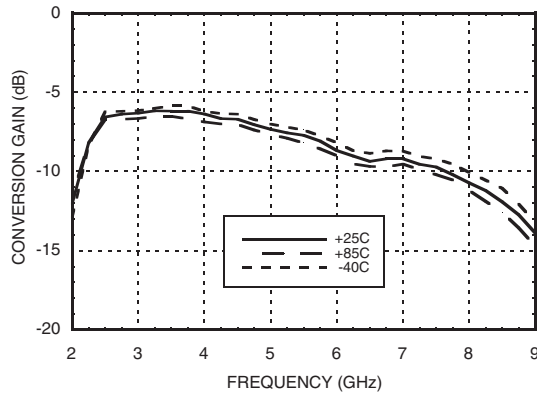

Isolation @ LO = +15 dBm

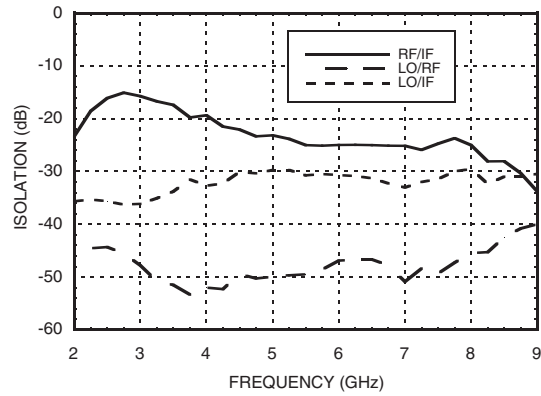

Conversion Gain vs. LO Drive

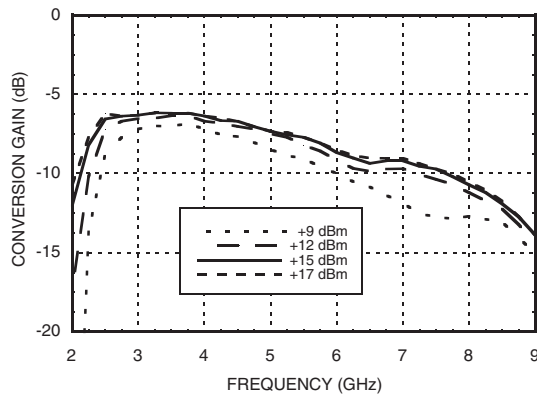

Return Loss @ LO = +15 dBm

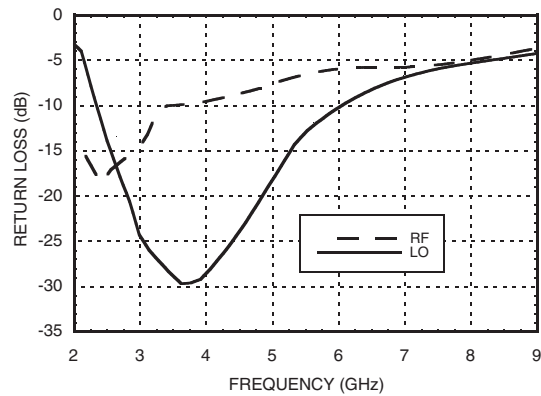

IF Bandwidth @ LO = +15 dBm

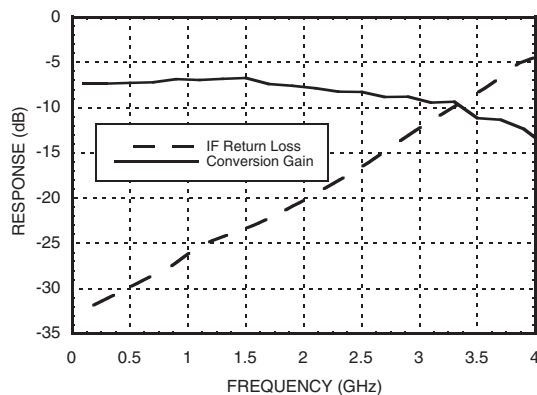

Upconverter Performance
Conversion Gain vs. LO Drive

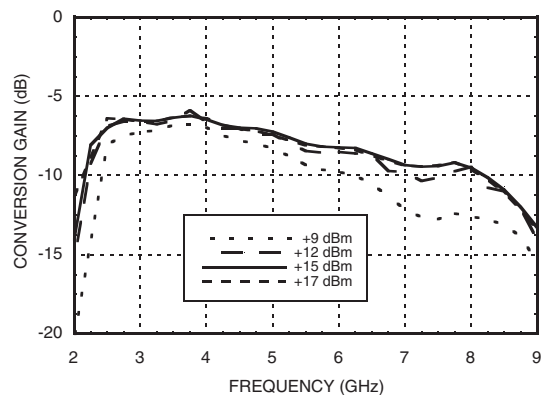



**GaAs MMIC FUNDAMENTAL
MIXER, 2.5 - 7.0 GHz**

Input IP3 vs. LO Drive *

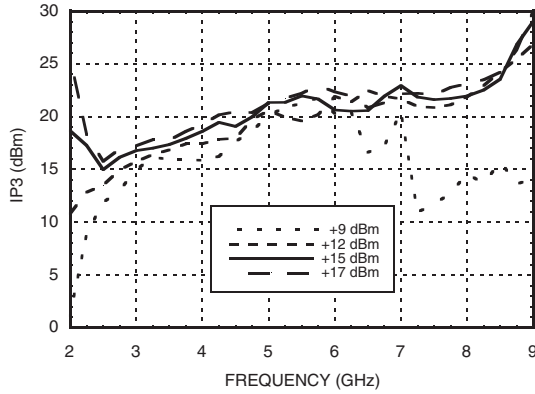

**Input IP3 vs. Temperature
@ LO = +15 dBm ***

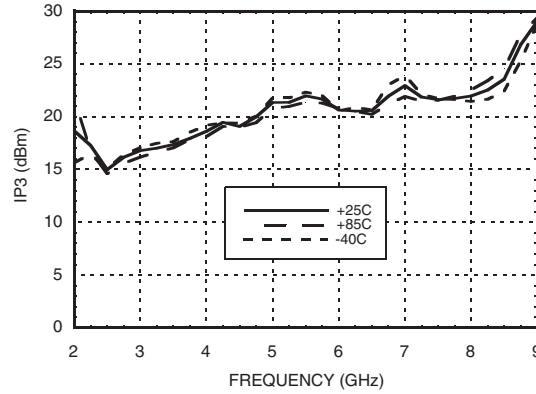

Input IP2 vs. LO Drive *

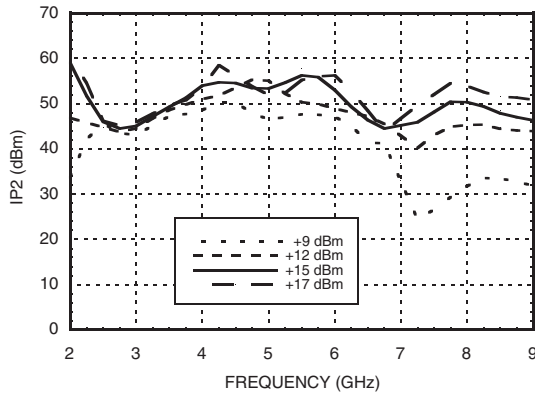

**Input IP2 vs. Temperature
@ LO = +15 dBm ***

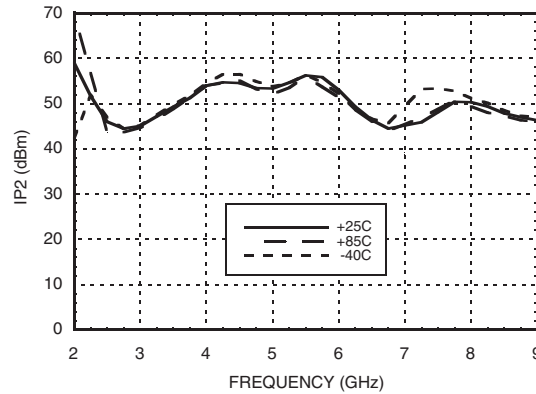

**Input P1dB vs. Temperature
@ LO = +15 dBm**

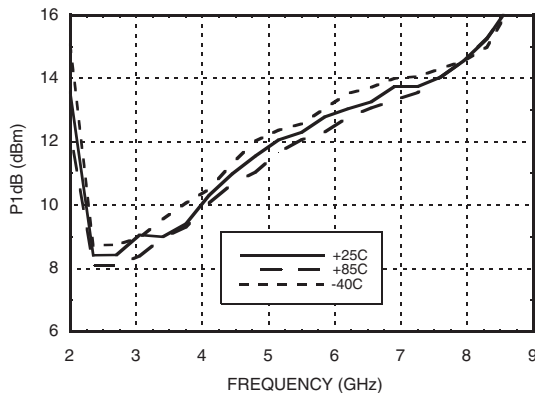

MxN Spurious Outputs

		nLO				
mRF		0	1	2	3	4
0	xx	-1	28	25	52	
1	17	0	37	40	69	
2	77	57	69	56	77	
3	77	77	77	74	77	
4	77	77	77	77	77	

RF = 5.1 GHz @ -10 dBm
LO = 5 GHz @ +15 dBm
All values in dBc below the IF output power level.

* Two-tone input power = -10 dBm each tone, 1 MHz spacing.



Absolute Maximum Ratings

RF / IF Input	+25 dBm
LO Drive	+25 dBm
Channel Temperature	150 °C
Continuous Pdiss (T = 85 °C) (derate 5.2 mW/°C above 85 °C)	339 mW
Thermal Resistance (channel to ground paddle)	192 °C/W
Storage Temperature	-65 to +150 °C
Operating Temperature	-40 to +85 °C



**ELECTROSTATIC SENSITIVE DEVICE
OBSERVE HANDLING PRECAUTIONS**

Outline Drawing

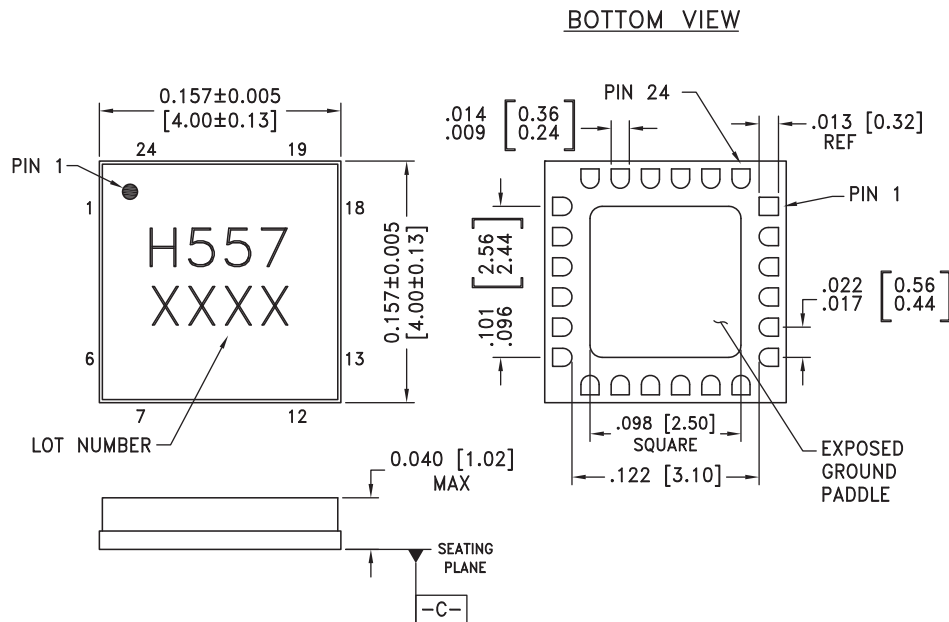

NOTES:

1. PACKAGE BODY MATERIAL: ALUMINA.
2. LEAD AND GROUND PADDLE PLATING:
30-80 MICROINCHES GOLD OVER 50 MICROINCHES MINIMUM NICKEL.
3. DIMENSIONS ARE IN INCHES (MILLIMETERS).
4. LEAD SPACING TOLERANCE IS NON-CUMULATIVE.
5. CHARACTERS TO BE HELVETICA MEDIUM, .025 HIGH, BLACK INK, OR LASER MARK LOCATED APPROX. AS SHOWN.
6. PACKAGE WARP SHALL NOT EXCEED 0.05MM DATUM - C -
7. ALL GROUND LEADS AND GROUND PADDLE MUST BE SOLDERED TO PCB RF GROUND.
8. CLASSIFIED AS MOISTURE SENSITIVITY LEVEL (MSL) 1.

For price, delivery, and to place orders, please contact Hittite Microwave Corporation:
20 Alpha Road, Chelmsford, MA 01824 Phone: 978-250-3343 Fax: 978-250-3373

www.BDTC.com/Hittite/



Pin Descriptions

Pin Number	Function	Description	Interface Schematic
1, 5 - 7, 11 - 14, 18 - 24	N/C	No connection required. These pins may be connected to RF/DC ground without affecting performance.	
2, 4, 8, 10, 15, 17	GND	Package bottom must also be connected to RF/DC ground.	
3	LO	This pin is DC coupled and matched to 50 Ohms.	
9	IF	This pin is DC coupled. For applications not requiring operation to DC, this port should be DC blocked externally using a series capacitor whose value has been chosen to pass the necessary IF frequency range. For operation to DC, this pin must not source or sink more than 2 mA of current or part non-function and possible part failure will result.	
16	RF	This pin is DC coupled and matched to 50 Ohms.	

Evaluation PCB

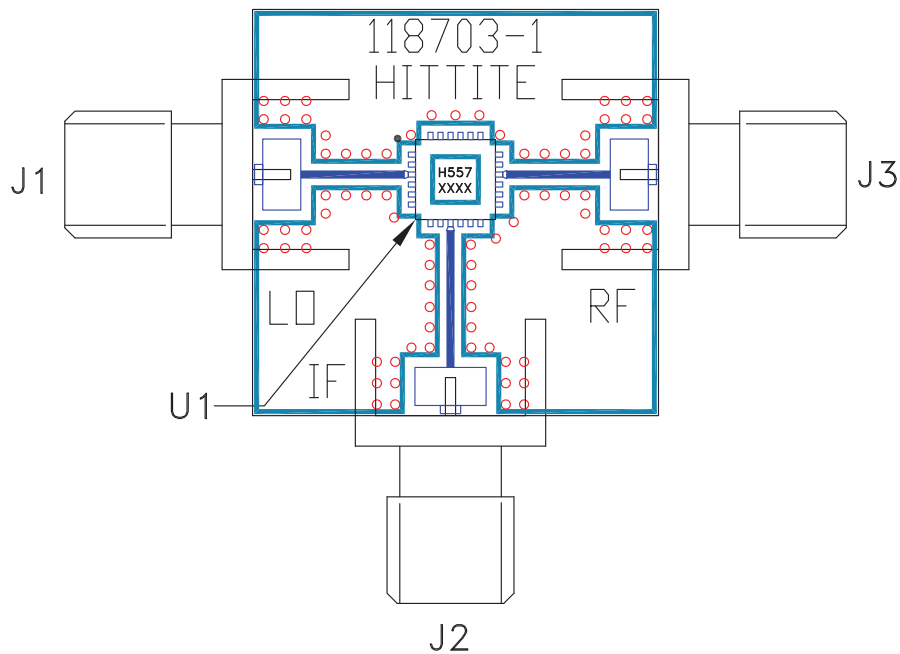

List of Materials for Evaluation PCB 118704 [1]

Item	Description
J1 - J2	SRI SMA Connector
J3	Johnson SMA Connector
U1	HMC557LC4 Mixer
PCB [2]	118703 Evaluation PCB

[1] Reference this number when ordering complete evaluation PCB

[2] Circuit Board Material: Rogers 4350

The circuit board used in this application should use RF circuit design techniques. Signal lines should have 50 ohm impedance while the package ground leads and exposed paddle should be connected directly to the ground plane similar to that shown. A sufficient number of via holes should be used to connect the top and bottom ground planes. The evaluation circuit board shown is available from Hittite upon request.