



### Typical Applications

Low Noise wideband MMIC VCO is ideal for:

- Industrial/Medical Equipment
- Test & Measurement Equipment
- Military Radar, EW & ECM

### Features

- Wide Tuning Bandwidth
- Pout: +1 dBm
- Low SSB Phase Noise: -95 dBc/Hz @100 kHz
- No External Resonator Needed
- Single Positive Supply: +5V @ 57 mA
- 24 Lead Ceramic 4x4 mm SMT Package: 16 mm<sup>2</sup>

### Functional Diagram

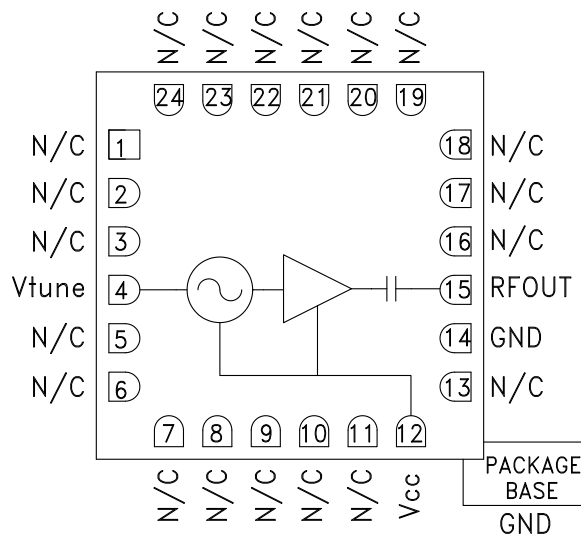

### General Description

The HMC732LC4B is a wideband MMIC Voltage Controlled Oscillator which incorporates the resonator, negative resistance device, and varactor diode. Output power and phase noise performance are excellent over temperature due to the oscillator's monolithic construction. The Vtune port accepts an analog tuning voltage from 0 to +23V. The HMC732LC4B VCO operates from a single +5V supply, consumes only 57 mA of current, and is housed in a RoHS compliant SMT package. This wideband VCO uniquely combines the attributes of ultra small size, low phase noise, low power consumption, and wide tuning range.

### Electrical Specifications, $T_A = +25\text{ }^\circ\text{C}$ , $V_{cc} = +5V$ [1]

Parameter	Min.	Typ.	Max.	Units
Frequency Range	6 - 12			GHz
Power Output		1		dBm
SSB Phase Noise @ 10 kHz Offset		-65		dBc/Hz
SSB Phase Noise @ 100 kHz Offset		-95		dBc/Hz
Tune Voltage (Vtune)	0		23	V
Supply Current (Icc) (Vcc = +5V)		57		mA
Tune Port Leakage Current (Vtune = +23V)		10		$\mu\text{A}$
Output Return Loss		15		dB
2nd Harmonic		-12		dBc
Pulling (into a 2.0:1 VSWR)		7		MHz pp
Pushing @ Vtune= +20V, F = 12 GHz		-85		MHz/V
Frequency Drift Rate @ 6 GHz		0.4		MHz/ $^\circ\text{C}$
Frequency Drift Rate @ 12 GHz		0.25		MHz/ $^\circ\text{C}$

[1] A load VSWR of  $\leq 2.0:1$ , across the frequency range of 0.01-14 GHz, is required for proper operation.



## WIDEBAND MMIC VCO WITH BUFFER AMPLIFIER 6 - 12 GHz

**Frequency vs. Tuning Voltage, Vcc = +5V**

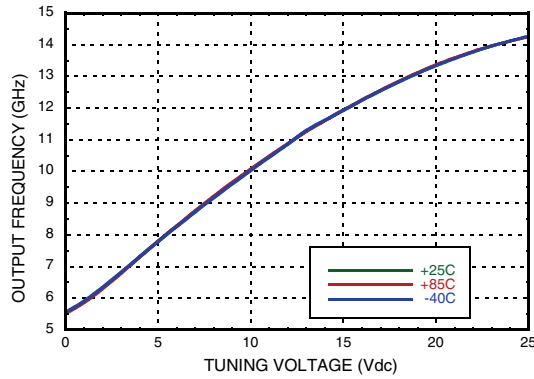

**Frequency vs. Tuning Voltage, T = +25 °C**

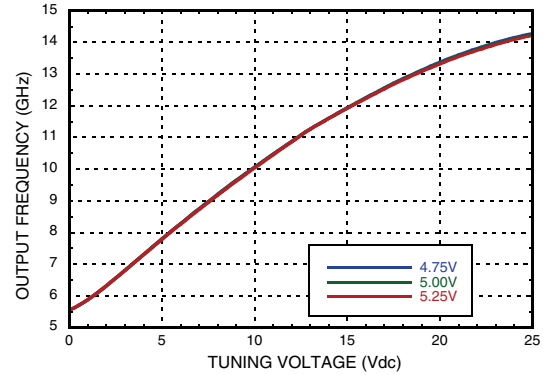

**Sensitivity vs. Tuning Voltage, Vcc = +5V**

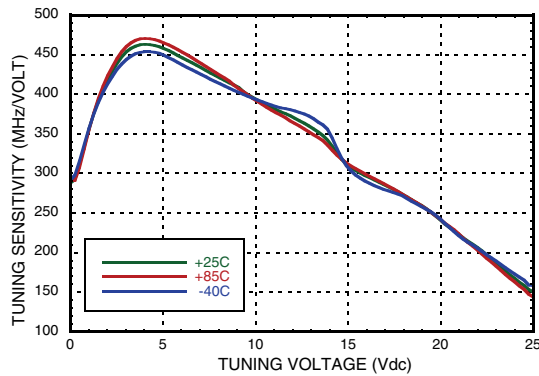

**Output Power vs. Tuning Voltage, Vcc = +5V**

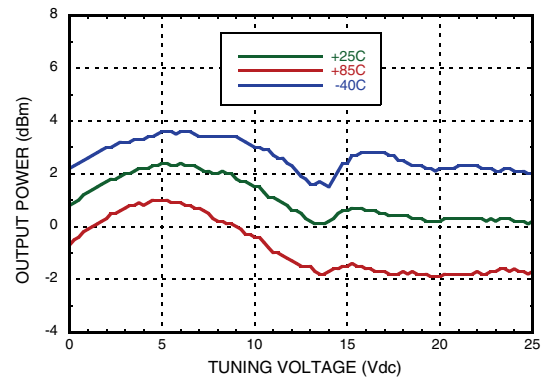

**SSB Phase Noise vs. Tuning Voltage**

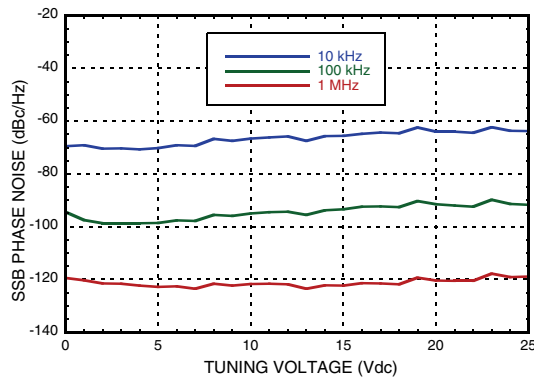

**Typical SSB Phase Noise @ Vtune = +5V**

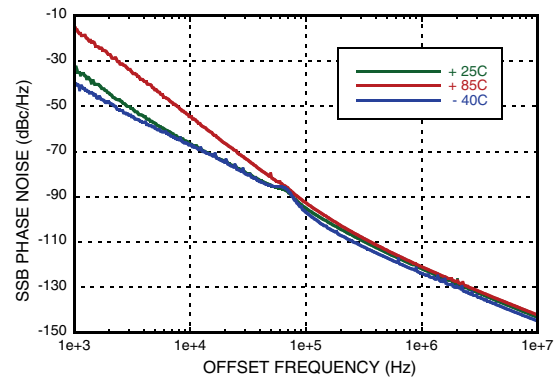

### Supply Current vs. Vcc, T = 25 °C

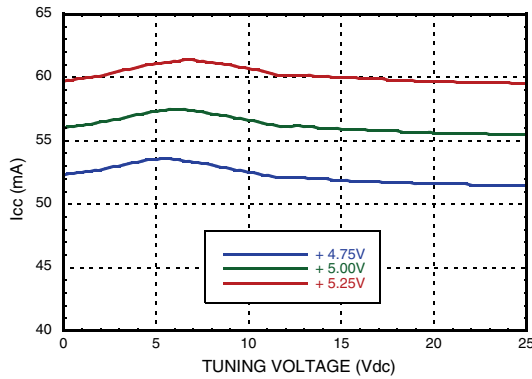

### Absolute Maximum Ratings

Vcc	+5.5 V
Vtune	-1 to +25V
Storage Temperature	-65 °C to +150 °C
ESD Sensitivity (HBM)	Class 1A

### Reliability Information

Junction Temperature To Maintain 1 Million Hour MTTF	135 °C
Nominal Junction Temperature (T = 85 °C)	110 °C
Thermal Resistance (Junction to GND paddle, 5V supply)	91 °C/W
Operating Temperature	-40 °C to + 85 °C



ELECTROSTATIC SENSITIVE DEVICE  
OBSERVE HANDLING PRECAUTIONS

### Outline Drawing

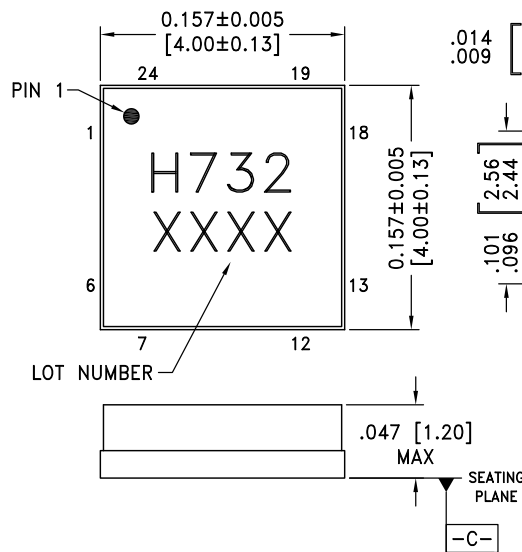

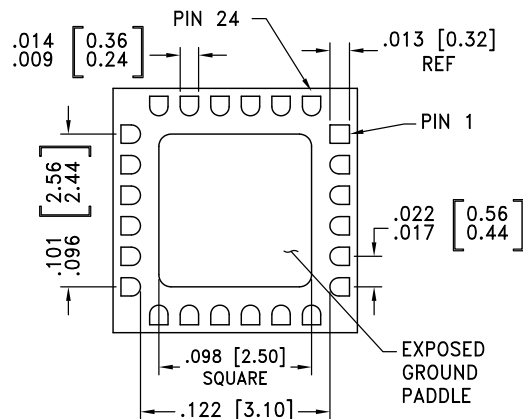

### BOTTOM VIEW



#### NOTES:

1. PACKAGE BODY MATERIAL: ALUMINA
2. LEAD AND GROUND PADDLE PLATING: GOLD FLASH OVER NI.
3. DIMENSIONS ARE IN INCHES [MILLIMETERS].
4. LEAD SPACING TOLERANCE IS NON-CUMULATIVE.
5. PACKAGE WARP SHALL NOT EXCEED 0.05mm DATUM -C-
6. ALL GROUND LEADS AND GROUND PADDLE MUST BE SOLDERED TO PCB RF GROUND.

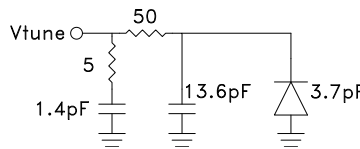
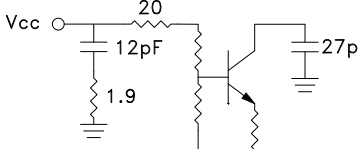
**WIDEBAND MMIC VCO WITH BUFFER AMPLIFIER**  
**6 - 12 GHz**
**Pin Descriptions**

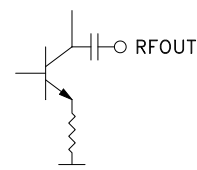
Pin Number	Function	Description	Interface Schematic
1 - 3, 5 - 11, 13, 16 - 24	N/C	No Connection. These pins may be connected to RF/DC ground. Performance will not be affected.	
4	Vtune	Control Voltage and Modulation Input. Modulation bandwidth dependent on drive source impedance. See "Determining the FM Bandwidth of a Wideband Varactor Tuned VCO" application note.	
12	Vcc	Supply Voltage Vcc= +5V	
14	GND	Package bottom has an exposed metal paddle that must also be RF & DC grounded.	
15	RFOUT	RF output (AC coupled) (A load VSWR of $\leq 2.0:1$ , across the frequency range of 0.01-14 GHz, is required for proper operation.)	

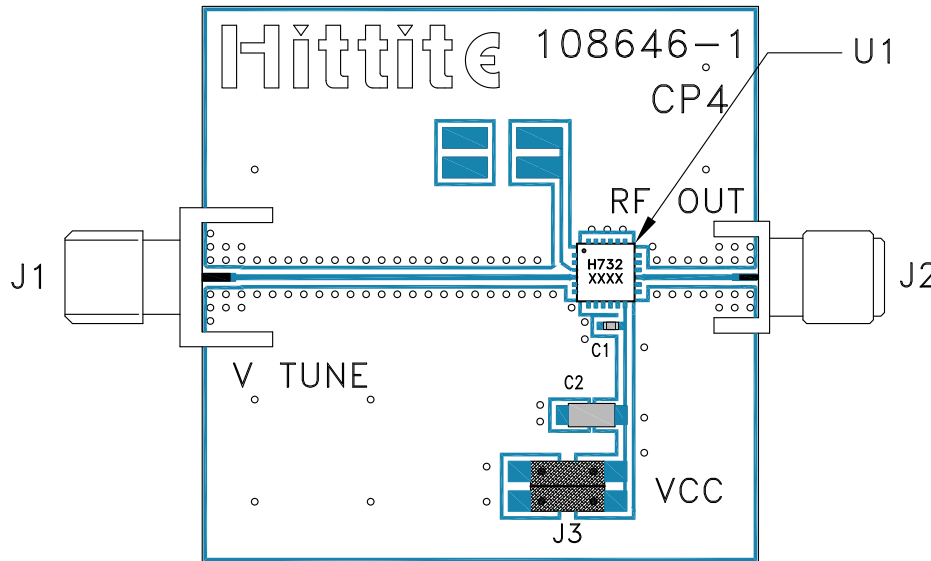
**Evaluation PCB**

**List of Materials for Evaluation PCB 108648 [1]**

Item	Description
J1	RF Connector, SMA
J2	RF Connector, SMA
J3	DC Header
C1	1000 pF Capacitor, 0402 Pkg.
C2	4.7 μF Capacitor, Tantalum
U1	HMC732LC4B VCO
PCB [2]	108646 Eval Board

[1] Reference this number when ordering complete evaluation PCB

[2] Circuit Board Material: Arlon 25FR or Rogers 4350

The circuit board used in the application should use RF circuit design techniques. Signal lines should have 50 Ohm impedance while the package ground leads and exposed ground paddle should be connected directly to the ground plane similar to that shown. A sufficient number of via holes should be used to connect the top and bottom ground planes. The evaluation circuit board shown is available from Hittite upon request.



**WIDEBAND MMIC VCO WITH BUFFER AMPLIFIER**  
**6 - 12 GHz**

**Notes:**