

Typical Applications

The HMC819LC5 is ideal for:

- Point-to-Point and Point-to-Multi-Point Radio
- Military Radar, EW & ELINT
- Satellite Communications
- Sensors

Features

- High Conversion Gain: 15 dB
- Excellent Sideband Rejection: -35 dBc
- 2 LO to RF Isolation: 12 dB
- High Output IP3: +35 dBm
- 32 Lead 5x5 mm SMT Ceramic Package: 25 mm²

Functional Diagram

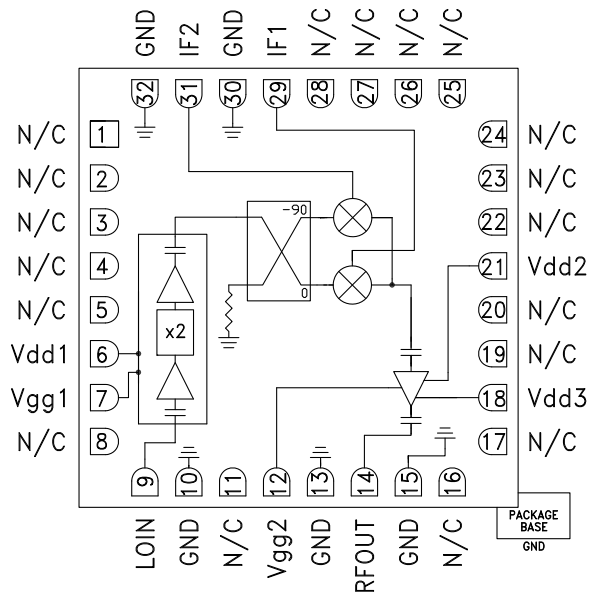

General Description

The HMC819LC5 is a compact GaAs MMIC I/Q upconverter in a leadless RoHS compliant SMT package. This device provides a small signal conversion gain of 15 dB with -35 dBc of sideband rejection. The HMC819LC5 utilizes a driver amplifier preceded by an I/Q mixer where the LO is driven by an active x2 multiplier. IF1 and IF2 mixer inputs are provided and an external 90° hybrid is needed to select the required sideband. The I/Q mixer topology reduces the need for filtering of the unwanted sideband. The HMC819LC5 is a much smaller alternative to hybrid style single sideband upconverter assemblies and it eliminates the need for wire bonding by allowing the use of surface mount manufacturing techniques.

Electrical Specifications ^{[1][2]}, T_A = +25°C

IF = 2500 MHz, LO = +7 dBm, Vgg1 = -1.7V Vdd1, 2, 3 = +5V, Idd2 + Idd3 = 270 mA USB ^{[1][3]}

Parameter	Min.	Typ.	Max.	Units
Frequency Range, RF		17.6 - 23.7		GHz
Frequency Range, LO		6.6 - 11.6		GHz
Frequency Range, IF		DC - 3.75		GHz
Conversion Gain	11	15		dB
Sideband Rejection		-35		dBc
1 dB Compression (Output)	19	23		dBm
2 LO to RF Isolation		12		dB
2 LO to IF Isolation ^[2]		20		dB
IP3 (Output)		35		dBm
Supply Current Idd1		95	120	mA
Supply Current Idd2 + Idd3 ^[3]		270	300	mA

[1] Unless otherwise noted all measurements performed with high side LO, IF = 2500 MHz and external IF 90° hybrid.

[2] Data taken without external IF 90° hybrid.

[3] Adjust Vgg2 between -2 to 0V to achieve Idd2 + Idd3 = 270 mA Typical.

For price, delivery and to place orders: Hittite Microwave Corporation, 2 Elizabeth Drive, Chelmsford, MA 01824

Phone: 978-250-3343 Fax: 978-250-3373 Order On-line at www.hittite.com

Application Support Phone: 978-250-3343 or apps@hittite.com

Data Taken as SSB Upconverter with External IF 90° Hybrid, IF = 2500 MHz

Conversion Gain, USB vs. Temperature

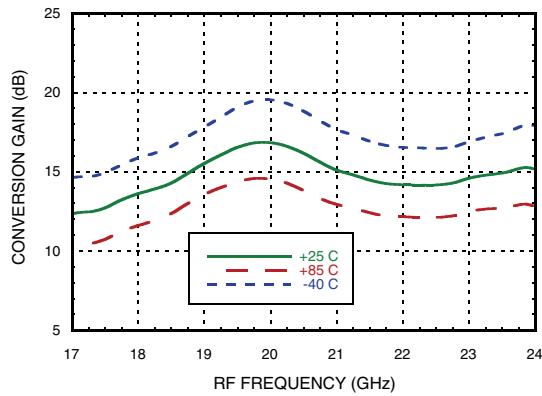

Conversion Gain, USB vs. LO Drive

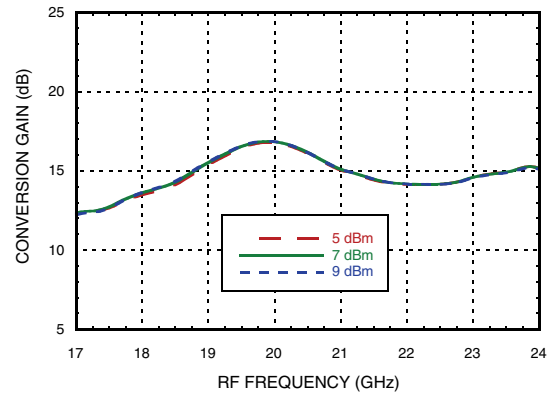

Conversion Gain, USB vs. Vdd

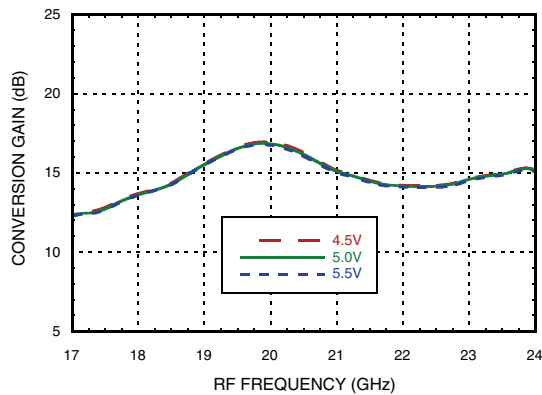

RF Return Loss vs. Temperature

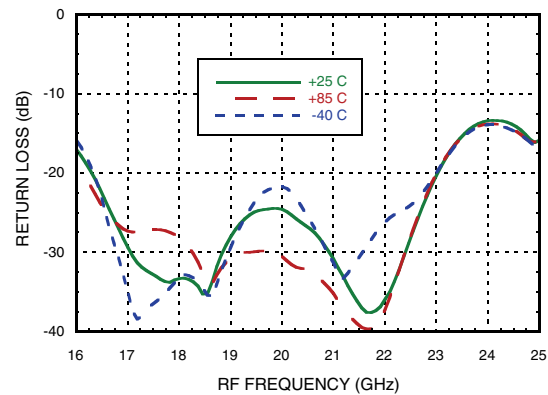

LO Return Loss vs. Temperature

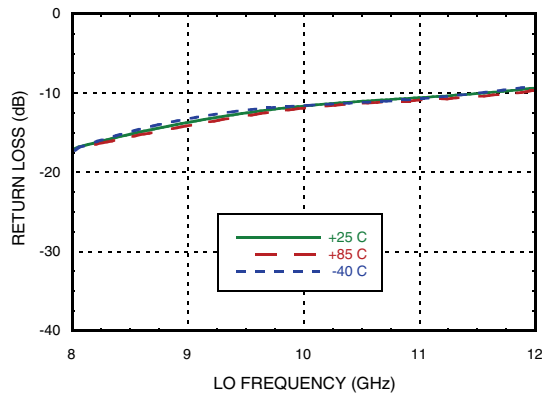

IF Return Loss [1]

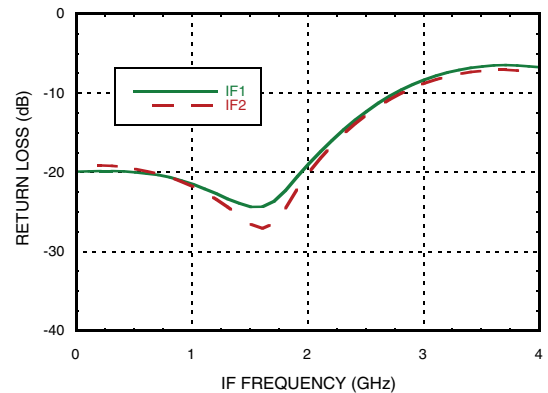

[1] Data taken without external IF 90° hybrid



GaAs MMIC I/Q UPCONVERTER 17.6 - 23.7 GHz

Data Taken as SSB Upconverter with External IF 90° Hybrid, IF = 2500 MHz

Side Band Rejection vs. Temperature

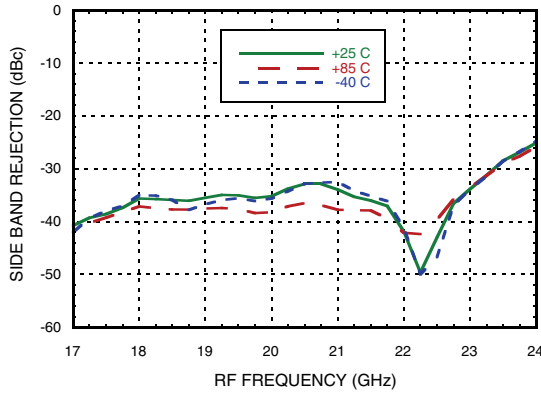

Input P1dB, USB vs. Temperature

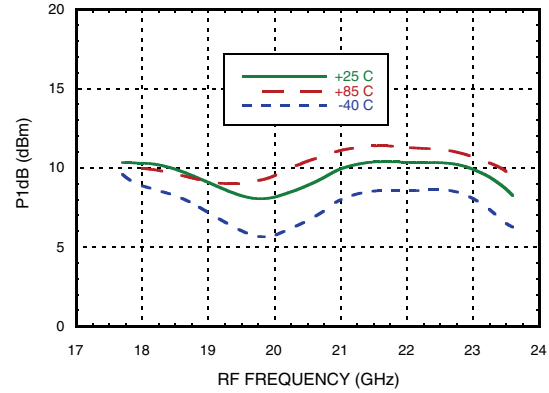

Output P1dB, USB vs. Temperature

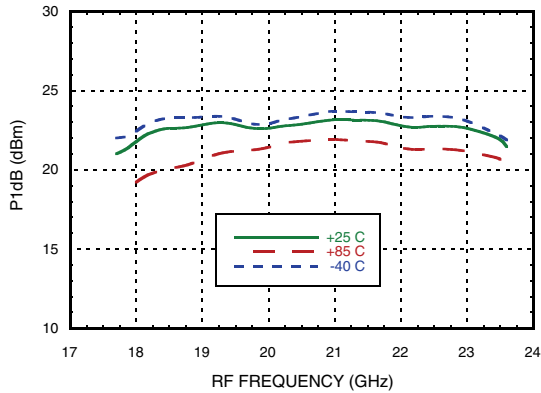

Input IP3, USB vs. Temperature

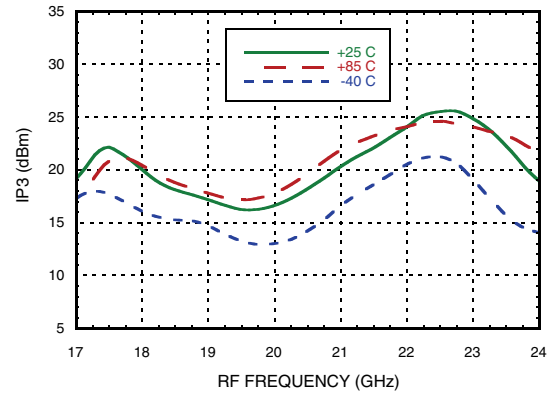

Output IP3, USB vs. Temperature

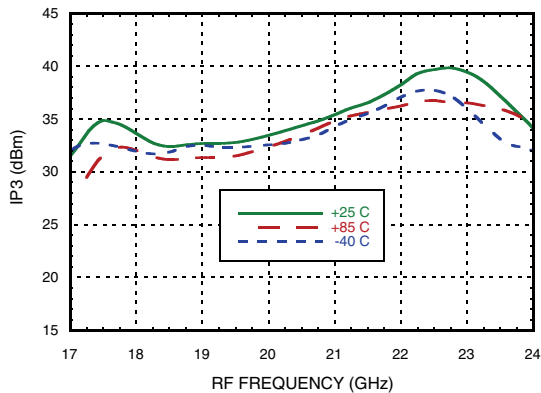

Input IP3, USB vs. LO Drive

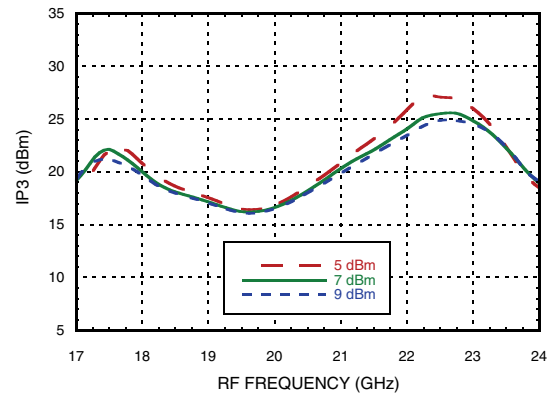

Data Taken as SSB Upconverter with External IF 90° Hybrid, IF = 2500 MHz

Output IP3, USB vs. LO Drive

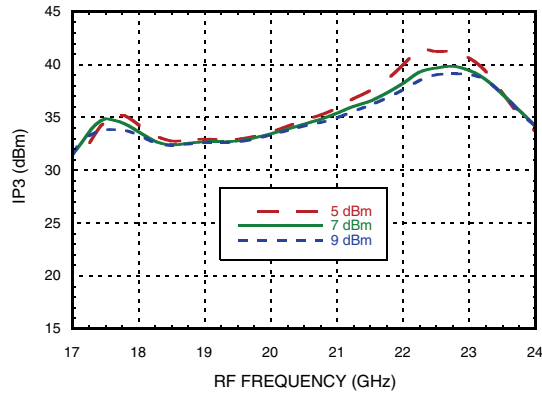

Input IP3, USB vs. Vdd

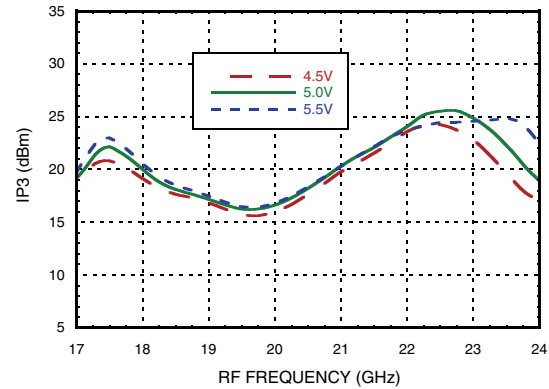

Output IP3, USB vs. Vdd

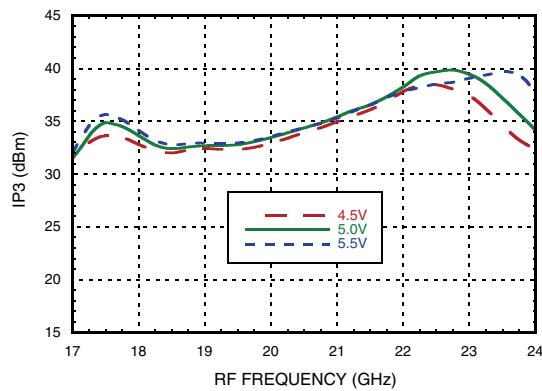

Isolations with 2LO [1]

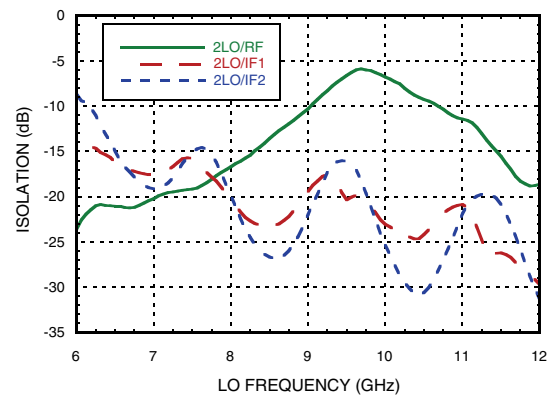

Isolations with LO [1]

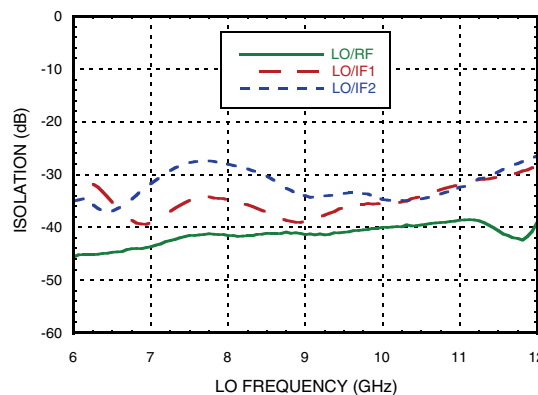

[1] Data taken without external IF 90° hybrid

Data Taken as SSB Upconverter with External IF 90° Hybrid, IF = 100 MHz

Conversion Gain, USB vs. Temperature

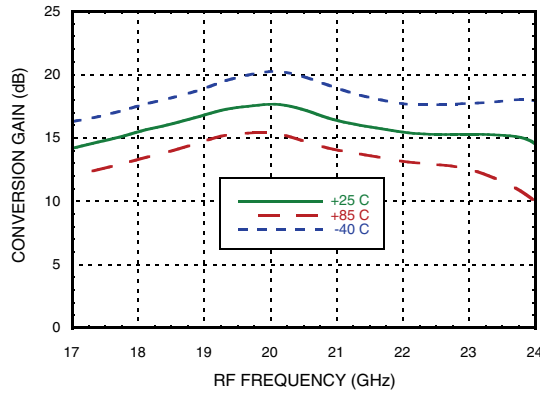

Conversion Gain, USB vs. LO Drive

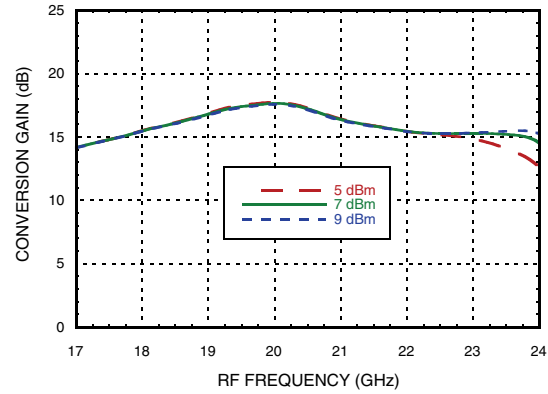

Conversion Gain, USB vs. Vdd

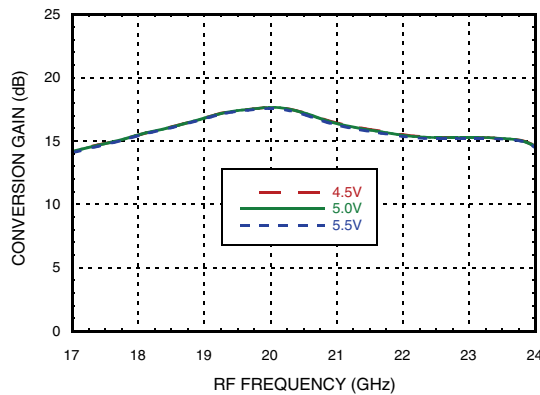

Sideband Rejection vs. Temperature

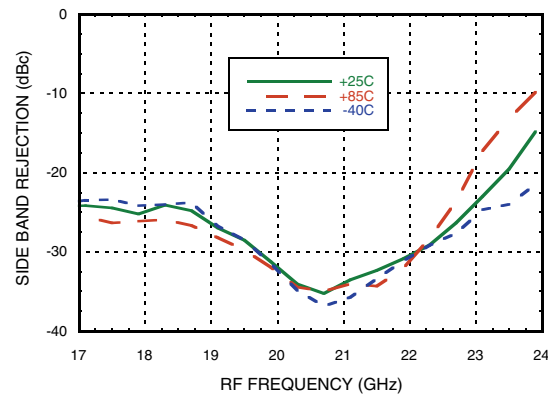

Input IP3, USB vs. Temperature

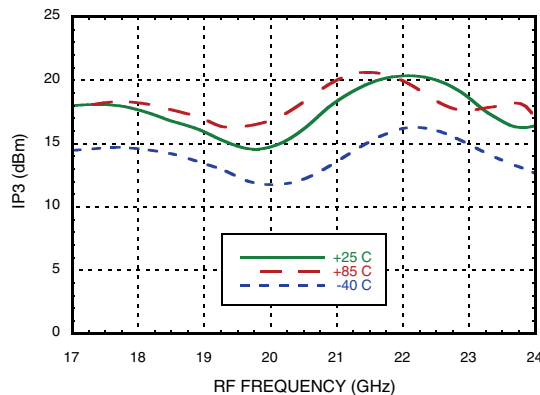

Output IP3, USB vs. Temperature

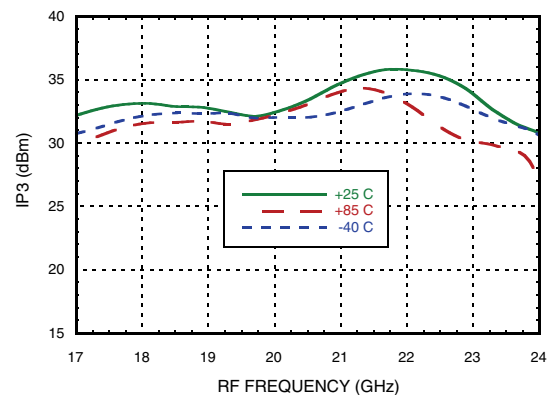



Data Taken as SSB Upconverter with External IF 90° Hybrid, IF = 3750 MHz

Conversion Gain, USB vs. Temperature

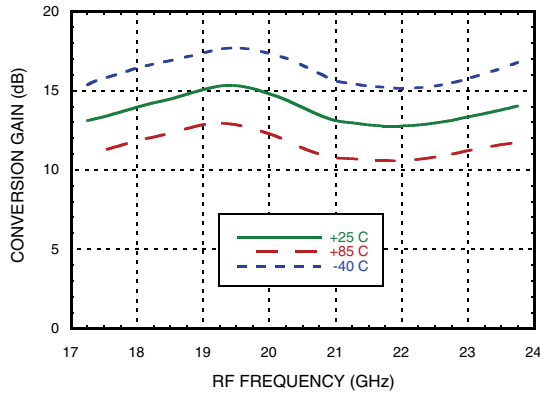

Conversion Gain, USB vs. Temperature

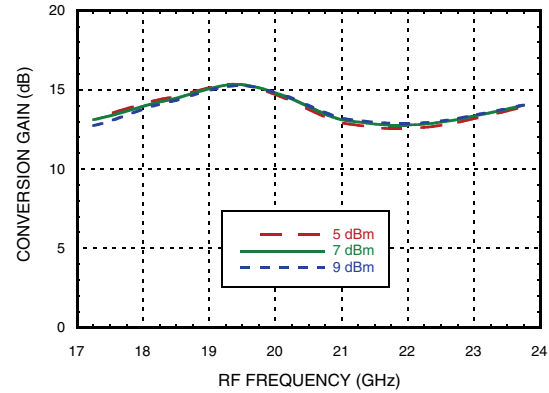

Conversion Gain, USB vs. Temperature

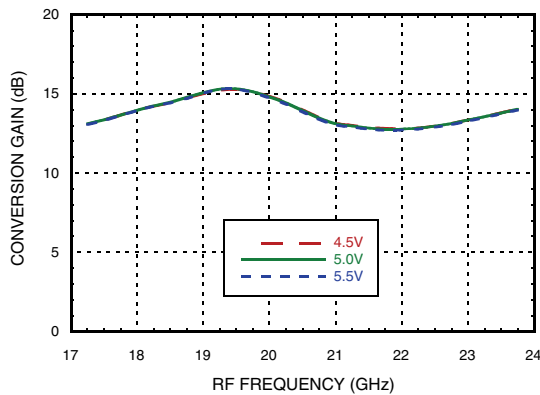

Sideband Rejection vs. Temperature

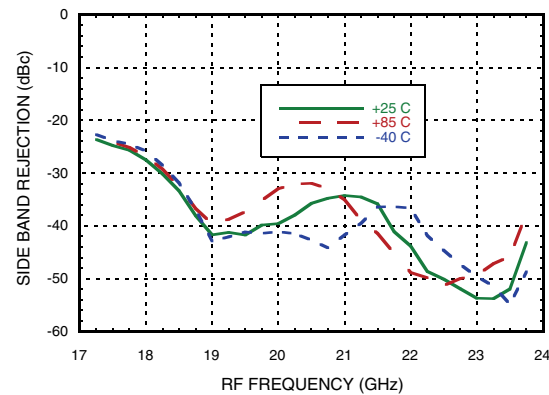

Input IP3, USB vs. Temperature

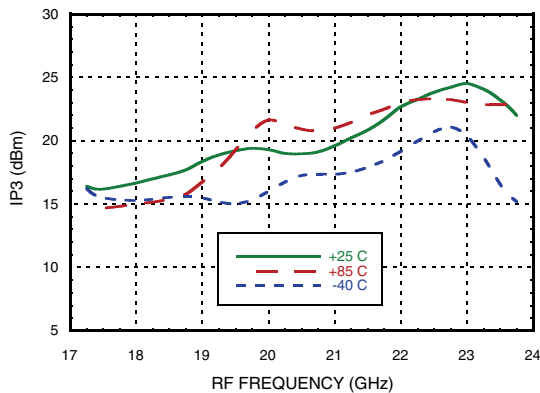

Output IP3, USB vs. Temperature

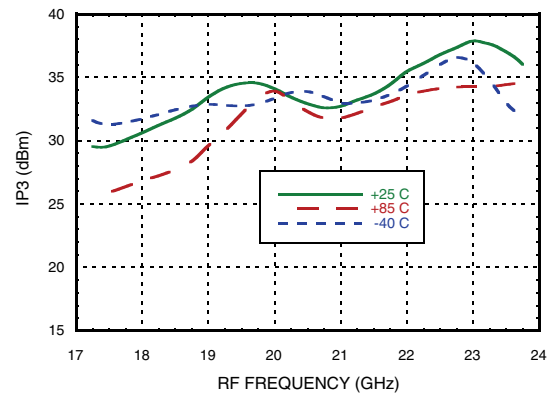



Data Taken as SSB Upconverter with External IF 90° Hybrid, IF = 2500 MHz

Conversion Gain, LSB vs. Temperature

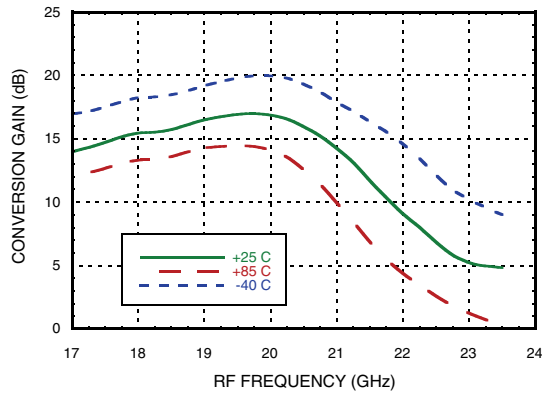

Conversion Gain, LSB vs. LO Drive

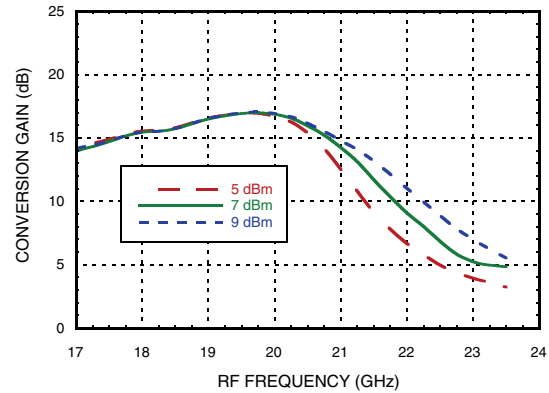

Conversion Gain, LSB vs. Vdd

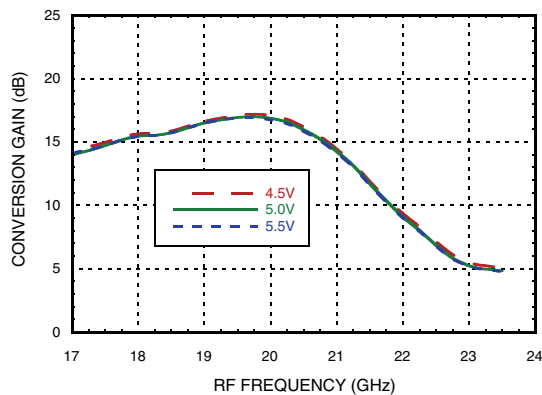

Input P1dB, LSB vs. Temperature

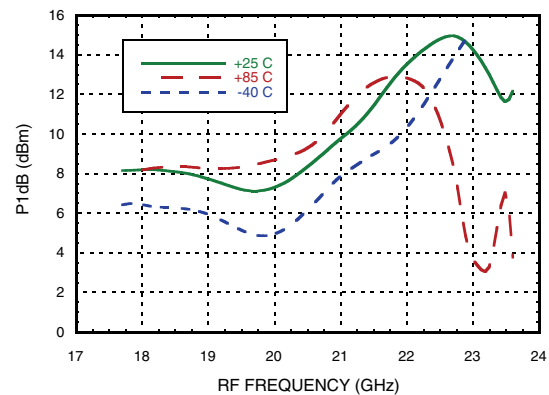

Output P1dB, LSB vs. Temperature

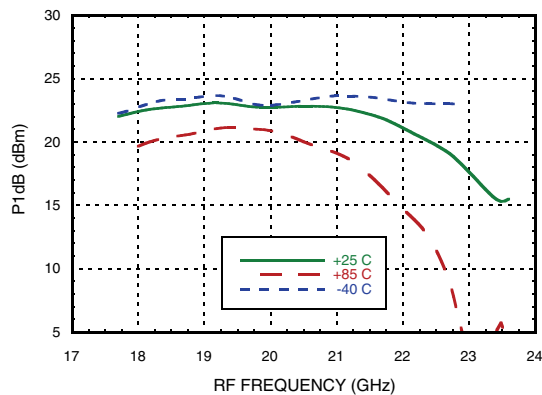

Input IP3, LSB vs. Temperature

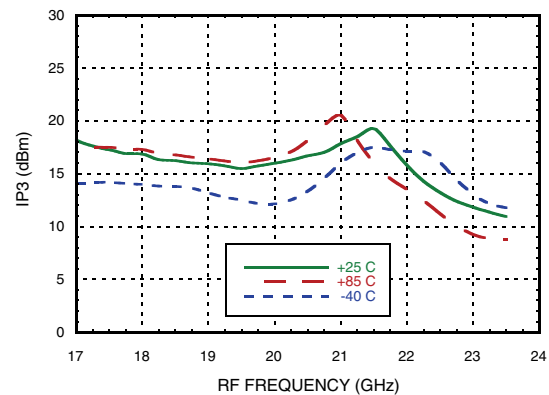



Data Taken as SSB Upconverter with External IF 90° Hybrid, IF = 2500 MHz

Output IP3, LSB vs. Temperature

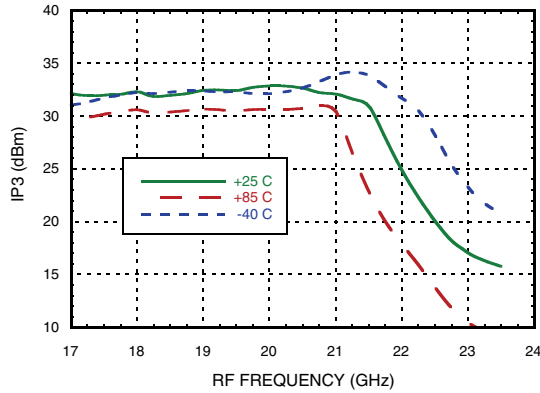

Input IP3, LSB vs. LO Drive

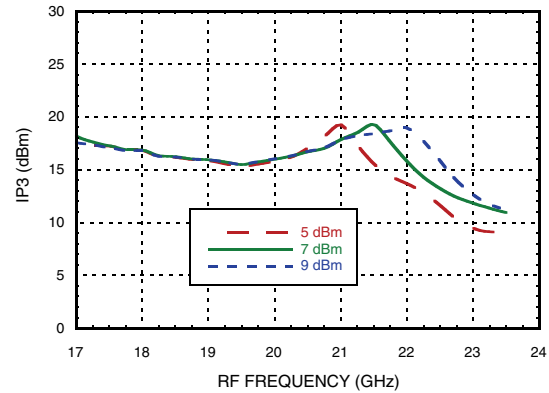

Output IP3, LSB vs. LO Drive

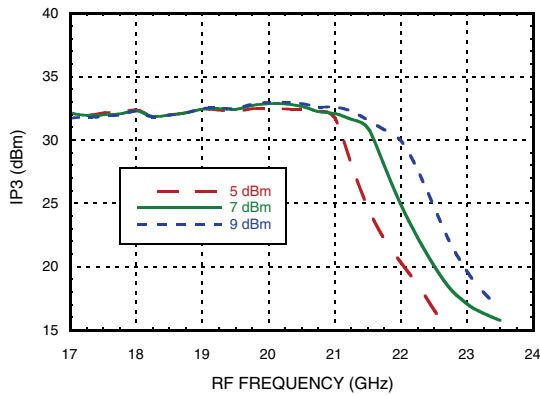

Input IP3, LSB vs. Vdd

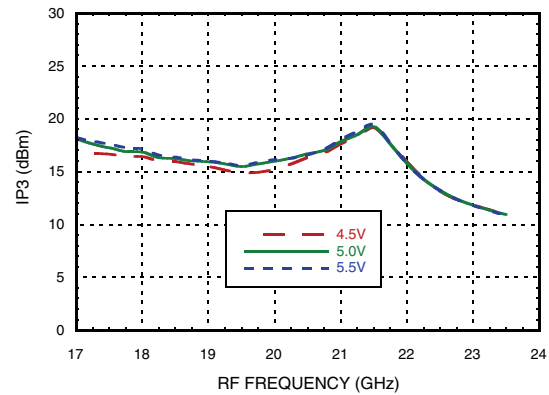

Output IP3, LSB vs. Vdd

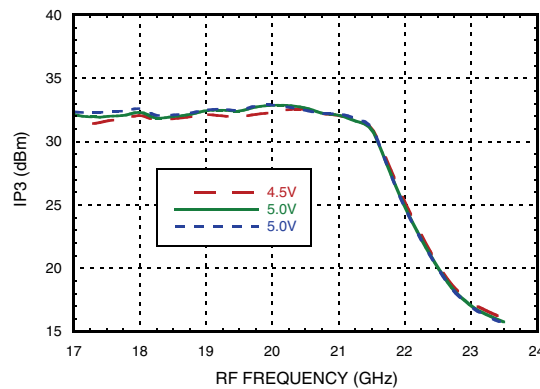

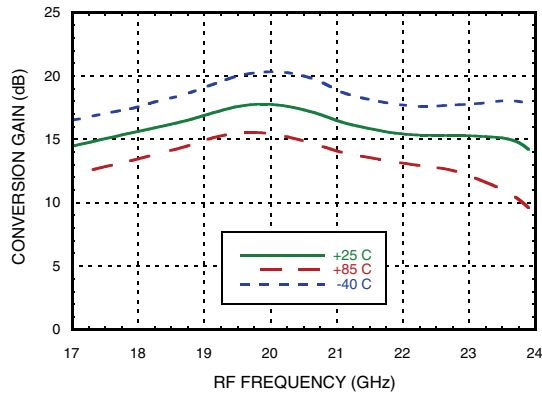
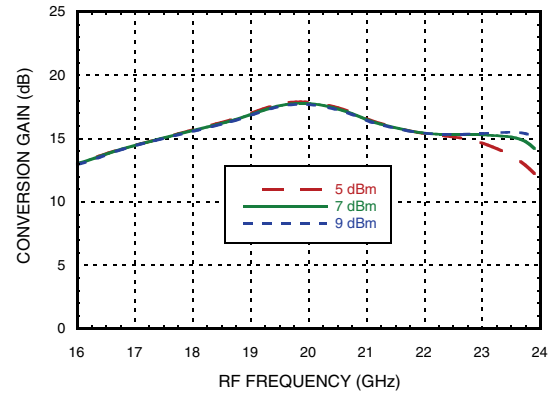
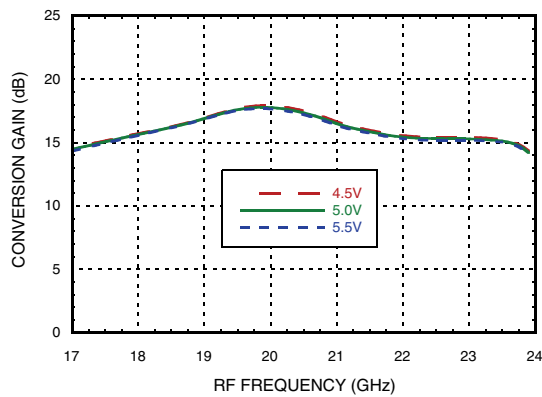
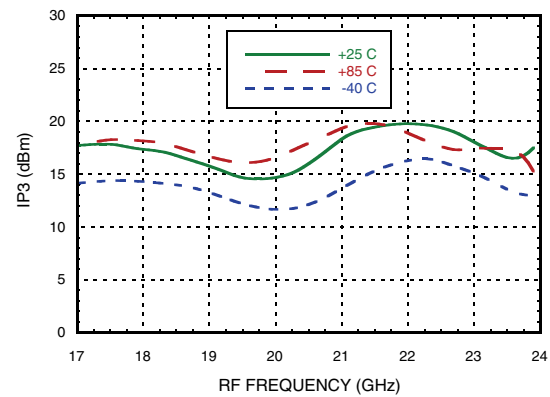
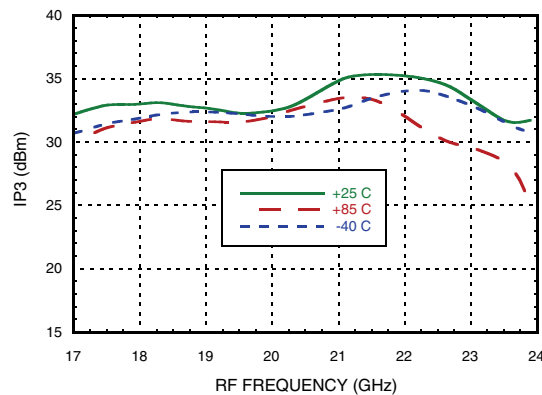

Data Taken as SSB Upconverter with External IF 90° Hybrid, IF = 100 MHz

Conversion Gain, LSB vs. Temperature

Conversion Gain, LSB vs. LO Drive

Conversion Gain, LSB vs. Vdd

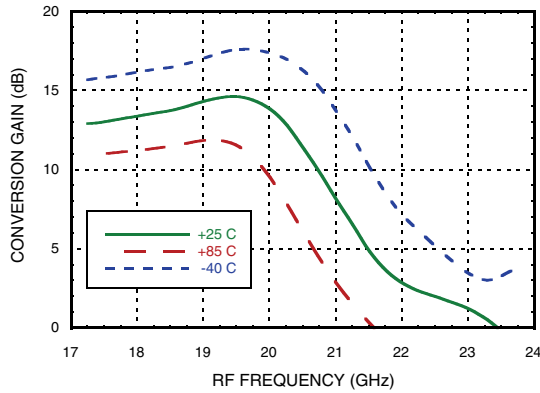
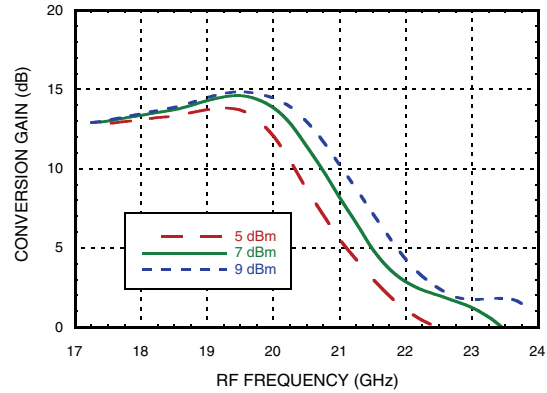
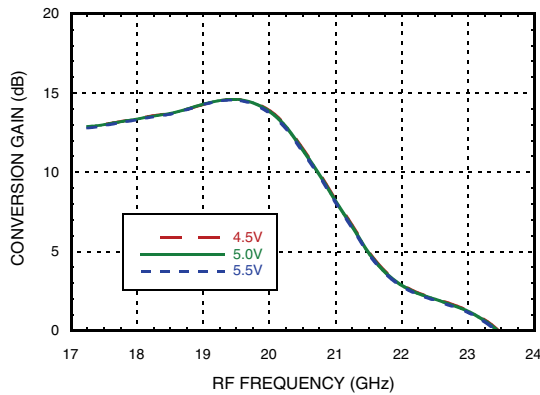
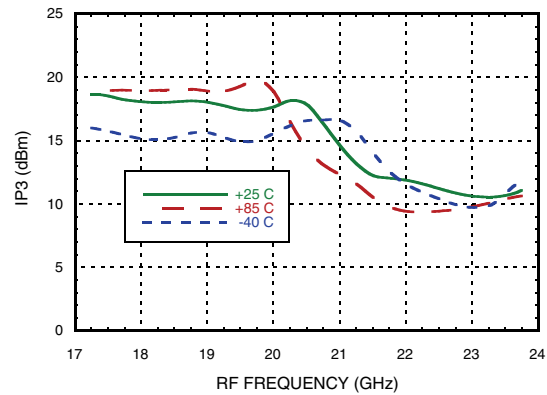
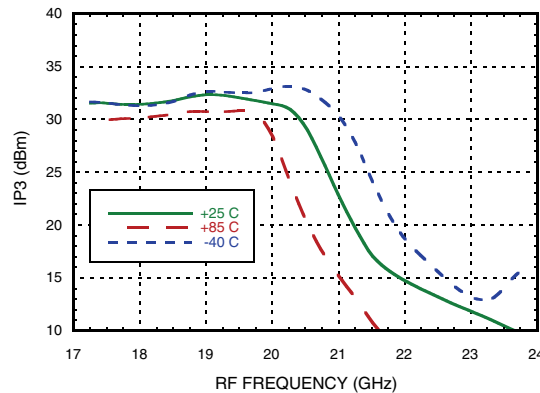
Input IP3, LSB vs. Temperature

Output IP3, LSB vs. Temperature



Data Taken as SSB Upconverter with External IF 90° Hybrid, IF = 3750 MHz

Conversion Gain, LSB vs. Temperature

Conversion Gain, LSB vs. LO Drive

Conversion Gain, LSB vs. Vdd

Input IP3, LSB vs. Temperature

Output IP3, LSB vs. Temperature



**GaAs MMIC I/Q UPCONVERTER
17.6 - 23.7 GHz**
MxN Spurious Outputs [1][2]

mIF	nLO				
	0	1	2	3	4
0	X	-38.6	-11.6	-22.6	-46.6
1	-73.6	-78.6	0	-18.6	-53.6
2	-71.6	-73.6	-56.6	-77.6	-55.6
3	-115.6	-73.6	-68.6	-98.6	XX
4	-110.6	-94.6	-104.6	XX	XX

IF = 2.5 GHz @ -10 dBm
LO = 7.6 GHz @ 7 dBm

MxN Spurious Outputs [1][2]

mIF	nLO				
	0	1	2	3	4
0	X	-39.9	-11.9	-15.9	-51.9
1	-68.9	-67.9	0	-44.9	-55.9
2	-68.9	-66.9	-55.9	-82.9	-52.9
3	-112.9	-76.9	-71.9	-100.9	XX
4	-107.9	-98.9	-105.9	XX	XX

IF = 2.5 GHz @ -10 dBm
LO = 8.1 GHz @ 7 dBm

MxN Spurious Outputs [1][2]

mIF	nLO				
	0	1	2	3	4
0	X	-39.6	-8.4	-24.6	-42.6
1	-64.6	-63.6	0	-57.6	-54.6
2	-66.6	-71.6	-69.6	-94.6	-54.6
3	-103.6	-85.6	-66.6	-104.6	-103.6
4	-104.6	-102.6	-100.6	XX	XX

IF = 2.5 GHz @ -10 dBm
LO = 8.6 GHz @ 7 dBm

MxN Spurious Outputs [1][2]

mIF	nLO				
	0	1	2	3	4
0	X	-38.9	-3.9	-47.9	-49.9
1	-62.9	-55.9	0	-82.9	-51.9
2	-63.9	-58.9	-67.9	-88.9	-64.9
3	-100.9	-81.9	-65.9	-100.9	XX
4	-98.9	-106.9	-97.9	XX	XX

IF = 2.5 GHz @ -10 dBm
LO = 9.1 GHz @ 7 dBm

MxN Spurious Outputs [1][2]

mIF	nLO				
	0	1	2	3	4
0	X	-36.5	0.9	-49.5	-37.5
1	-62.5	-52.5	0	-76.5	-57.5
2	-58.5	-56.5	-54.5	-84.5	-64.5
3	-105.5	-87.5	-73.5	-102.5	XX
4	-99.5	-105.5	-99.5	XX	XX

IF = 2.5 GHz @ -10 dBm
LO = 9.6 GHz @ 7 dBm

MxN Spurious Outputs [1][2]

mIF	nLO				
	0	1	2	3	4
0	X	-33.7	-0.2	-48.7	-30.7
1	-62.7	-46.7	0	-73.7	-63.7
2	-56.7	-56.7	-69.7	-88.7	XX
3	-94.7	-86.7	-68.7	XX	XX
4	-91.7	XX	-97.7	XX	XX

IF = 2.5 GHz @ -10 dBm
LO = 10.1 GHz @ 7 dBm

[1] Data taken without external IF 90° hybrid
[2] All values in dBc below RF power level (2LO + IF) USB

MxN Spurious Outputs [1][2]

mIF	nLO				
	0	1	2	3	4
0	X	-33.8	-1.5	-54.8	-30.8
1	-68.8	-45.8	0	-75.8	XX
2	-55.8	-51.8	-72.8	-83.8	XX
3	XX	-83.8	-66.8	XX	XX
4	-88.8	XX	XX	XX	XX

IF = 2.5 GHz @ -10 dBm
LO = 10.6 GHz @ 7 dBm

MxN Spurious Outputs [1][3]

mIF	nLO				
	0	1	2	3	4
0	X	-37.9	-0.2	-49.2	-30.9
-1	-63.1	-100.6	0	-57.6	-46.3
-2	-62.7	-104.6	-57.8	-54.2	-51.9
-3	-101.6	-118.6	-73.1	-85.4	-92.6
-4	-97.6	XX	-108.6	XX	-98.6

IF = 2.5 GHz @ -10 dBm
LO = 10.1 GHz @ 7 dBm

MxN Spurious Outputs [1][3]

mIF	nLO				
	0	1	2	3	4
0	X	-39	-4.3	-57	-34
-1	-71	-92	0	-66	-55
-2	-65	-105	-61	-79	-52
-3	-115	-120	-73	-88	-95
-4	-97	XX	-118	-110	-94

IF = 2.5 GHz @ -10 dBm
LO = 10.6 GHz @ 7 dBm

MxN Spurious Outputs [1][3]

mIF	nLO				
	0	1	2	3	4
0	X	-38.9	-5.9	-55.9	XX
-1	-66.9	-86.9	0	-78.9	-60.9
-2	-64.9	-94.9	-45.9	-94.9	-53.9
-3	-101.9	-120.9	-62.9	-88.9	-96.9
-4	-95.9	XX	-96.9	-117.9	-93.9

IF = 2.5 GHz @ -10 dBm
LO = 11.1 GHz @ 7 dBm

[1] Data taken without external IF hybrid

[2] All values in dBc below RF power level (2LO + IF) USB

[3] All values in dBc below RF power level (2LO - IF) LSB



GaAs MMIC I/Q UPCONVERTER 17.6 - 23.7 GHz

Absolute Maximum Ratings

Drain Bias Voltage (Vdd1, 2, 3)	5.5V
Gate Bias Voltage (Vgg1, Vgg2)	-2.5V to 0V
IF Input Power (IF1, IF2)	20 dBm
LO Drive (LO IN)	+10 dBm
Channel Temperature	175 °C
Continuous Pdiss (T = 85°C) (derate 24.9 mW/°C above 85°C)	2.24 W
Thermal Resistance (channel to ground paddle)	40.2 °C/W
Storage Temperature	-65 to +150 °C
Operating Temperature	-40 to +85 °C
ESD Sensitivity (HBM)	Class 1A

Harmonics of LO @ RF Output

LO Freq. (GHz)	nLO Spur @ RF Port			
	1	2	3	4
7.6	34	14	37	47
8.1	36	20	44	50
8.6	46	21	53	48
9.1	39	15	44	47
9.6	39	19	52	42
10.1	38	21	64	XX
10.6	37	20	56	XX
11.1	33	15	XX	XX

LO Power = +7 dBm

All values in dBc below input LO level, measured at RF port.



ELECTROSTATIC SENSITIVE DEVICE
OBSERVE HANDLING PRECAUTIONS

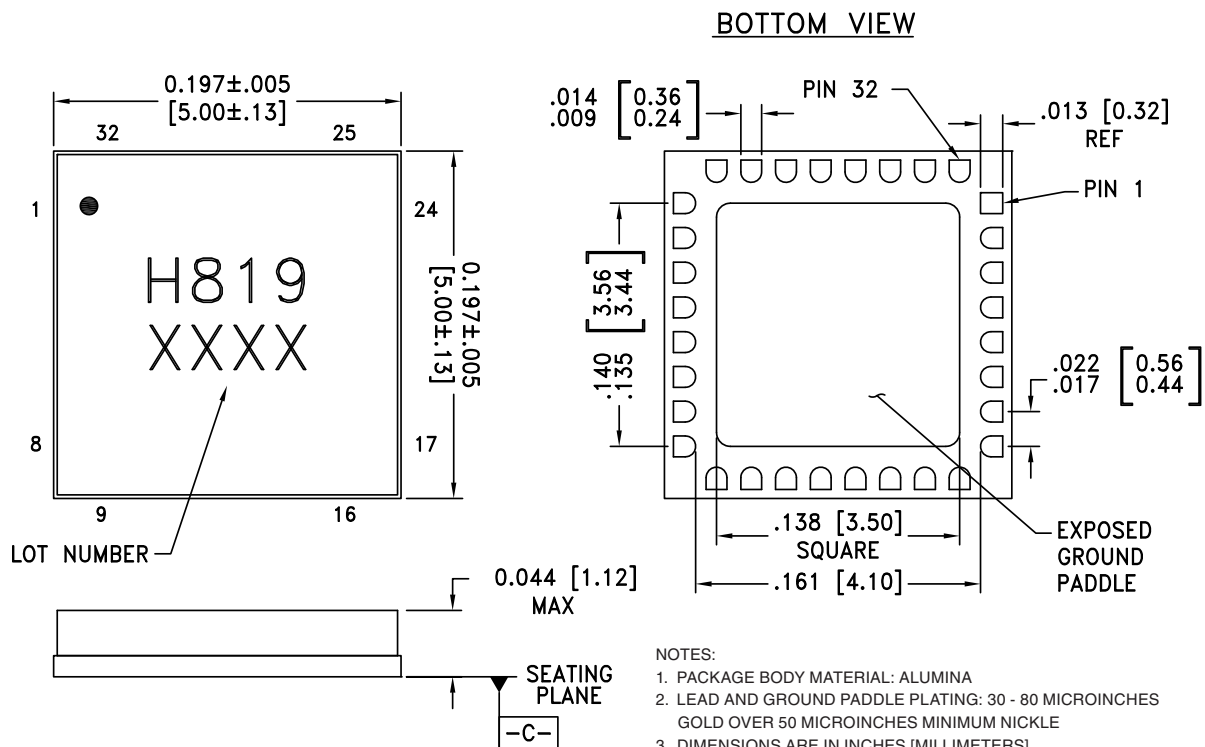

Outline Drawing



NOTES:

1. PACKAGE BODY MATERIAL: ALUMINA
2. LEAD AND GROUND PADDLE PLATING: 30 - 80 MICROINCHES GOLD OVER 50 MICROINCHES MINIMUM NICKLE
3. DIMENSIONS ARE IN INCHES [MILLIMETERS]
4. LEAD SPACING TOLERANCE IS NON-CUMULATIVE
5. PACKAGE WARP SHALL NOT EXCEED 0.05mm DATUM
6. ALL GROUND LEADS AND GROUND PADDLE MUST BE SOLDERED TO PCB RF GROUND

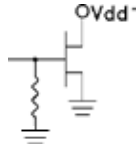
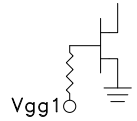
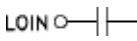
Pin Descriptions

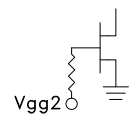
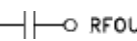
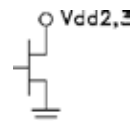
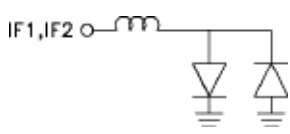
Pin Number	Function	Description	Interface Schematic
1 - 5, 8, 11, 16, 17, 19, 20, 22 - 28	N/C	No connection required. The pins are not connected internally; however, all data shown herein was measured with these pins connected to RF/DC ground externally.	
6	Vdd1	Power supply voltage for x2 multiplier. See application circuit for required external components.	
7	Vgg1	Gate control for x2 multiplier, set to -1.7V. See application circuit for required external components.	
9	LOIN	This pin is AC coupled and matched to 50 Ohms.	
10, 13, 15, 30, 32	GND	These pins and package bottom must be connected to RF/DC ground.	
12	Vgg2	Gate control for RF amplifier, please follow "MMIC Amplifier Biasing Procedure" application note. See application circuit for required external components.	
14	RFOUT	This pin is AC coupled and matched to 50 Ohms.	
18, 21	Vdd3, Vdd2	Power supply voltage for RF amplifier. See application circuit for required external components.	
29	IF1	Differential IF input pins. For applications not requiring operation to DC, an off chip DC blocking capacitor should be used. For operation to DC this pin must not source/sink more than 3mA of current or part non function and possible part failure will result.	
31	IF2		

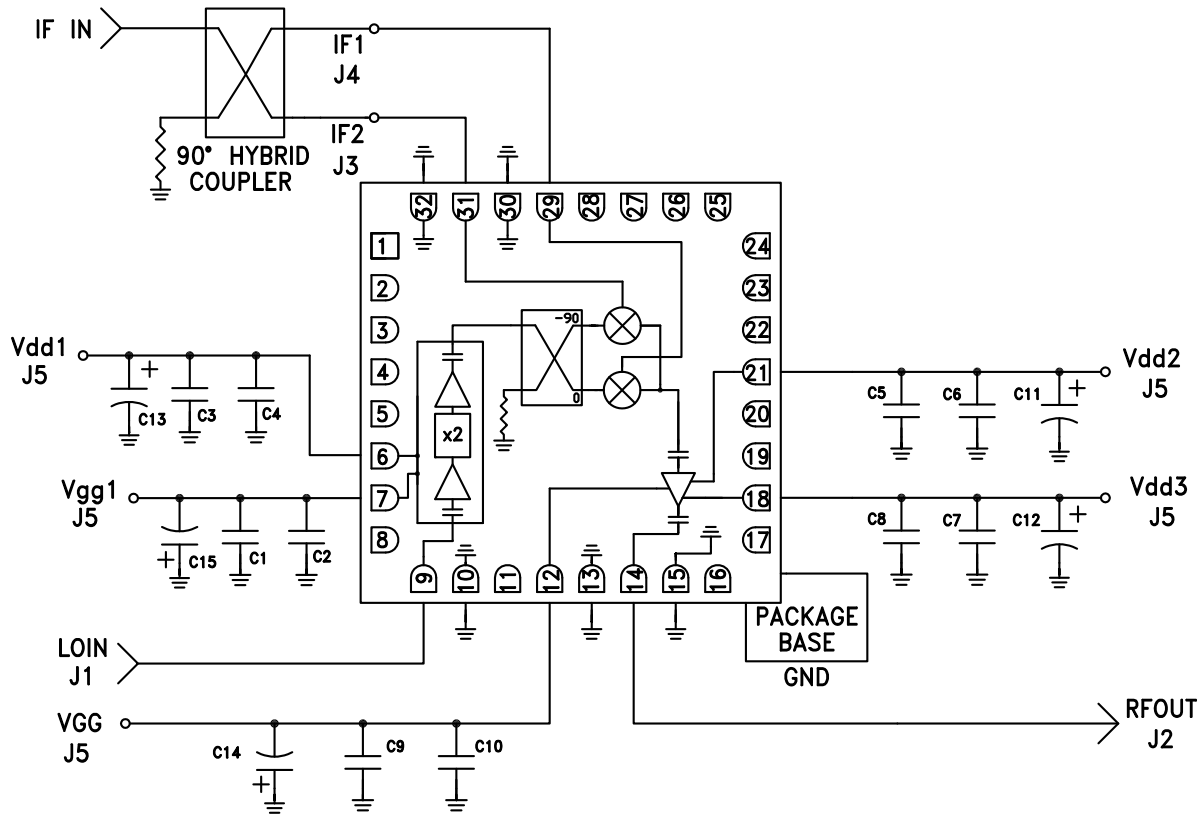
Typical Application

C1, C3, C6, C7, C10	1000 pF
C2, C4, C5, C8, C9	100 pF
C11 - C15	2.2 μ F

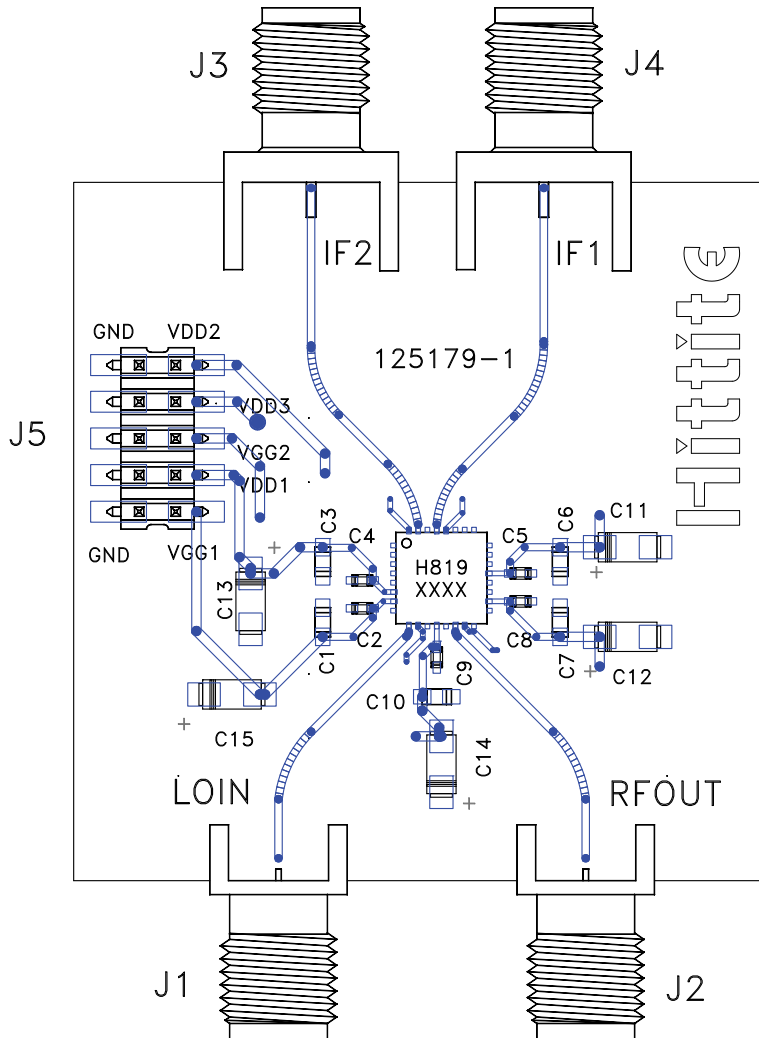
Evaluation PCB

List of Materials for Evaluation PCB 127607 [1]

Item	Description
J1, J2	PCB Mount 2.92 mm Connector
J3, J4	PCB Mount SMA Connector
J5	2mm 10 Pos Vert SMT
C1, C3, C6, C7, C10	1000 pF Capacitor, 0603 Pkg.
C2, C4, C5, C8, C9	100 pF Capacitor, 0402 Pkg.
C11 - C15	2.2 μ F Tantalum Capacitor, Case A
U1	HMC819LC5 Upconverter
PCB [2]	125179 Evaluation Board

[1] Reference this number when ordering complete evaluation PCB

[2] Circuit Board Material: Arlon 25FR, FR4 or Rogers 4350

The circuit board used in the application should use RF circuit design techniques. Signal lines should have 50 Ohm impedance while the package ground leads and exposed paddle should be connected directly to the ground plane similar to that shown. A sufficient number of via holes should be used to connect the top and bottom ground planes. The evaluation circuit board shown is available from Hittite upon request.