

MA4EX600L1-1225T



Silicon Double Balanced HMIC Mixer
1700 – 2500 MHz

Rev. V1

Features

- SOT-25 Low Cost Miniature Plastic Package
- 6.4 dB Typical Conversion Loss @ 5000 MHz
- + 3 to + 7 dBm LO Drive
- HMIC™ Patented Process
- NO External Matching Required
- Double Balanced Passive Mixer
- Lead Free (RoHS Compliant) with 260 °C Reflow Capability
- 100 % Matte Tin Plating

Description

M/A-COM's MA4EX600L1-1225T is a silicon monolithic 4.2 – 6.0GHz double balanced mixer in a low cost miniature surface mount SOT-25 package. The die uses M/A-COM's unique HMIC silicon/glass process to realize low loss passive elements while retaining the advantages of low barrier silicon Schottky diodes.

Applications

These mixers are well suited for high volume WLL and WLAN applications where small size and repeatability are required. Typical applications include frequency conversion, modulation, and demodulation in wireless receivers and transmitters.

Electrical Specifications @ +25°C

Parameter	Frequency Range	Test Conditions	Units	Min.	Typ.	Max.
Conversion Loss	5000 MHz 4.2 - 6.0 GHz	LO Drive = +5 dBm RF = -10 dBm, IF = 60 MHz	dB	-	6.4 6.8	8.0 9.5
L - R Isolation	5000 MHz 4.2 - 6.0 GHz	LO Drive = +5 dBm	dB	-	26 25	-
L - I Isolation	5000 MHz 4.2 - 6.0 GHz	LO Drive = +5 dBm	dB	-	24 23	-
R - I Isolation	5000 MHz 4.2 - 6.0 GHz	LO Drive = +5 dBm RF Level = - 10 dBm	dB	-	13 15	-
RF VSWR	5000 MHz 4.2 - 6.0 GHz	LO Drive = +5 dBm RF Level = - 10 dBm	Ratio	-	1.18:1 1.67:1	-
LO VSWR	5000 MHz 4.2 - 6.0 GHz	LO Drive = +5 dBm	Ratio	-	1.87:1 1.89:1	-
IF VSWR	10 - 2000 MHz	LO Drive = +5 dBm IF Level = 0 dBm	Ratio	-	1.55:1	-
Input IP3	5000 MHz 4.2 - 6.0 GHz	LO Drive = +5 dBm RF = -10 dBm, IF = 60 MHz	dBm	-	5.7 7.6	-
Input 1 dB Compression Power	5000 MHz 4.2 - 6.0 GHz	LO Drive = +5 dBm IF = 60 MHz	dBm	-	0.3 0.8	-
IF 1 dB Bandwidth	DC - 2000 MHz	LO = 5000 MHz @+5dBm	MHz	0	-	2000

SOT-25 Package Outline (Topview)

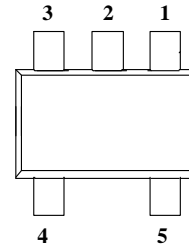

PIN Configuration

PIN	Function	PIN	Function
1	RF	4	GND
2	GND	5	IF
3	LO	—	—

Ordering Information

Model No.	Package
MA4EX600L1-1225T	Tape and Reel

ADVANCED: Data Sheets contain information regarding a product M/A-COM Technology Solutions is considering for development. Performance is based on target specifications, simulated results, and/or prototype measurements. Commitment to develop is not guaranteed.
PRELIMINARY: Data Sheets contain information regarding a product M/A-COM Technology Solutions has under development. Performance is based on engineering tests. Specifications are typical. Mechanical outline has been fixed. Engineering sample and/or test data may be available. Commitment to produce in volume is not guaranteed.

• **North America** Tel: 800.366.2266 • **Europe** Tel: +353.21.244.6400
• **India** Tel: +91.80.43537383 • **China** Tel: +86.21.2407.1588
Visit www.macomtech.com for additional data sheets and product information.

M/A-COM Technology Solutions Inc. and its affiliates reserve the right to make changes to the product(s) or information contained herein without notice.

MA4EX600L1-1225T



Silicon Double Balanced HMIC Mixer
1700 – 2500 MHz

Rev. V1

Typical Performance Curves (LO Drive = + 5 dBm, RF = -10dBm, IF = 60MHz)

Conversion Loss

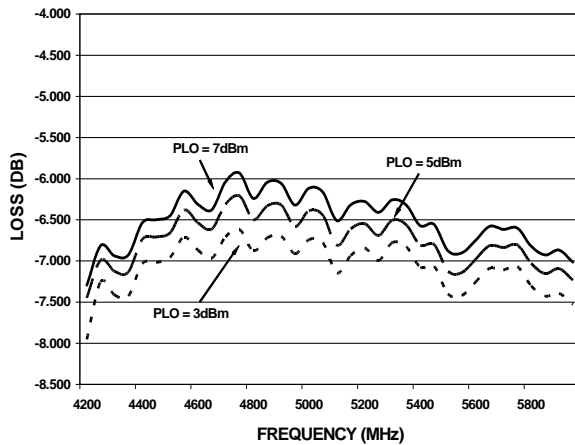

Isolation

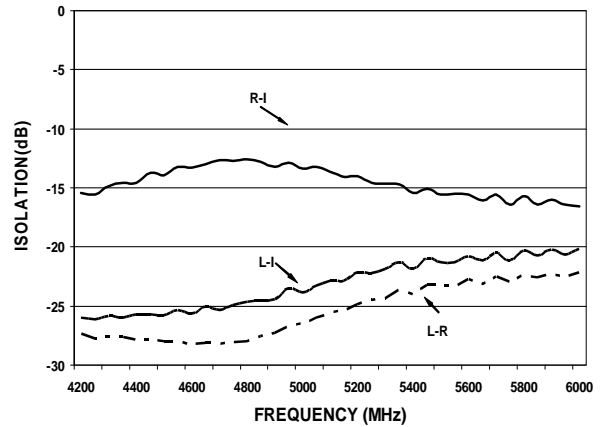

VSWR

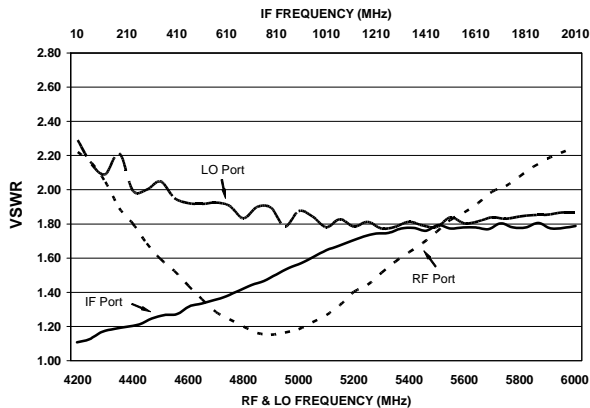

Input IP3 & 1dB Compression Power

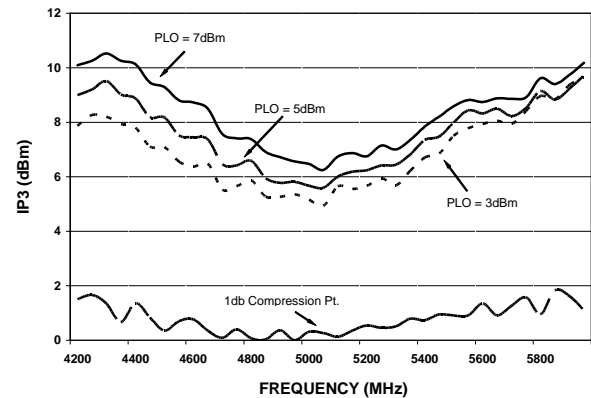

ADVANCED: Data Sheets contain information regarding a product M/A-COM Technology Solutions is considering for development. Performance is based on target specifications, simulated results, and/or prototype measurements. Commitment to develop is not guaranteed.
PRELIMINARY: Data Sheets contain information regarding a product M/A-COM Technology Solutions has under development. Performance is based on engineering tests. Specifications are typical. Mechanical outline has been fixed. Engineering samples and/or test data may be available. Commitment to produce in volume is not guaranteed.

• **North America** Tel: 800.366.2266 • **Europe** Tel: +353.21.244.6400
• **India** Tel: +91.80.43537383 • **China** Tel: +86.21.2407.1588
Visit www.macomtech.com for additional data sheets and product information.

M/A-COM Technology Solutions Inc. and its affiliates reserve the right to make changes to the product(s) or information contained herein without notice.

MA4EX600L1-1225T



Silicon Double Balanced HMIC Mixer
1700 – 2500 MHz

Rev. V1

Case Style

SOT-25

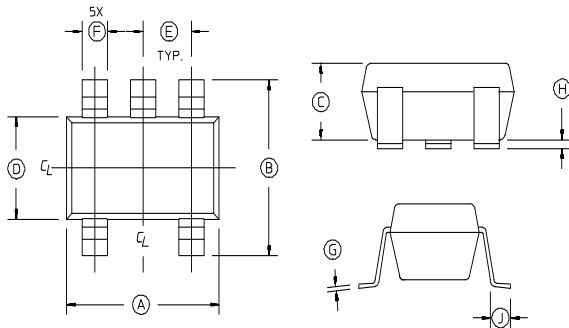

SOT-25

DIM	INCHES		MILLIMETERS	
	MIN	MAX	MIN	MAX
A	.1103	.1181	2.80	3.10
B	.1023	.1181	2.6	3.00
C	0.0355	.0512	0.9	1.30
D	0.0591	.0669	1.5	1.70
E	.0374 REF.		0.95 REF.	
F	.0138	.0197	.35	.50
G	.0031	0.0079	.08	0.2
H	.0002	.0059	.05	.15
J	.0138	.0216	.35	.55

- Dimensions do not include mold flas, protrusion or gate burrs which shall not exceed 0.0098 in (.25mm) per side.
- Leads Coplanarity should be 0.003 (0.08) max.

Absolute Maximum Ratings 1

Parameter	Maximum Ratings
Operating Temperature	-40°C to +85°C
Storage Temperature	-65°C to +150°C
Incident LO Power	+20 dBm
Incident RF Power	+20 dBm
Soldering Temperature	+260°C max.

- Exceeding these limits may cause permanent damage.
- * Please refer to application note M538 for surface mounting instructions.

Schematic

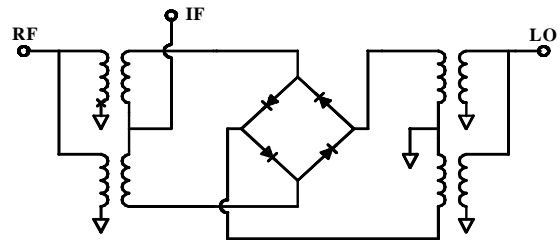

ADVANCED: Data Sheets contain information regarding a product M/A-COM Technology Solutions is considering for development. Performance is based on target specifications, simulated results, and/or prototype measurements. Commitment to develop is not guaranteed.
PRELIMINARY: Data Sheets contain information regarding a product M/A-COM Technology Solutions has under development. Performance is based on engineering tests. Specifications are typical. Mechanical outline has been fixed. Engineering samples and/or test data may be available. Commitment to produce in volume is not guaranteed.

• **North America** Tel: 800.366.2266 • **Europe** Tel: +353.21.244.6400
• **India** Tel: +91.80.43537383 • **China** Tel: +86.21.2407.1588
Visit www.macomtech.com for additional data sheets and product information.

M/A-COM Technology Solutions Inc. and its affiliates reserve the right to make changes to the product(s) or information contained herein without notice.