

## Features

- LNA Mixer integration
- Typical conversion gain of 7 dB
- Typical Two-Tone IM Ratio of  $\geq 50$  dBm
- LO Drive-Level: +13 dBm
- Low Cost / High Performance
- 50 ohm Nominal Impedance
- Lead-Free QSOP-16 Package
- 100% Matte Tin Plating over Copper
- Halogen-Free "Green" Mold Compound
- 260°C Reflow Compatible
- RoHS\* Compliant Version of SA65-0003

## Description

M/A-COM's MAIA-007495-000100 is an integrated assembly containing a GaAs FET MMIC LNA and GaAs FET mixer. This device is packaged in a 16 leaded QSOP plastic surface mount package. The amplifier can be biased with either +3V or +5V, the mixer requires no DC bias. The conversion gain of the integrated combination is typically 6 dB at +3V bias and 8 dB at +5V bias. The SA65-0003 is ideally suited for RF/IF communications applications requiring down conversion with some gain.

This MCM contains a mixer that is fabricated using a mature 1-micron GaAs process, it also contains an LNA that is fabricated using a low cost mature 0.5-micron gate length GaAs MESFET process. Both die feature full passivation for increased performance and reliability.

## Ordering Information

Part Number	Package
MAIA-007495-000100	Bulk Packaging
MAIA-007495-0001TR	1000 piece reel
MAIA-007495-0001TB	Sample Test Board

Note: Reference Application Note M513 for reel size information.

Note: Die quantity varies.

## Functional Block Diagram

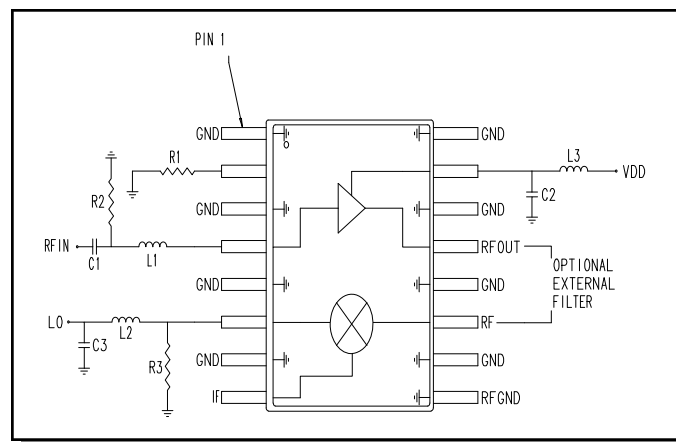

1. See "External Circuited Parts" on Sheet 3 for the values of the external components.

## Pin Configuration

Pin #	Function	Description
1	GND	RF and DC Ground
2	RES	External current control (optional)
3	GND	RF and DC Ground
4	RF IN	RF Input of the amplifier
5	GND	RF and DC Ground
6	LO	LO port of the mixer
7	GND	RF and DC Ground
8	IF	IF port of the mixer
9	RF GND	RF and DC Ground
10	GND	RF and DC Ground
11	RF <sup>2</sup>	RF port of the mixer
12	GND	RF and DC Ground
13	RF OUT <sup>2</sup>	RF output of the amplifier
14	GND	RF and DC Ground
15	V <sub>DD</sub>	Positive supply voltage
16	GND	RF and DC Ground

2. The output port of the amplifier, RFOUT, and the input port of the mixer, RF, are adjacently placed so that an external filter can be used.

\* Restrictions on Hazardous Substances, European Union Directive 2002/95/EC.

**Electrical Specifications:  $T_A = +25^\circ\text{C}$ ,  $Z_0=50\ \text{Ohms}$ ,  $\text{RF} = -10\ \text{dBm}^3$ ,  
 $\text{LO} = +13\ \text{dBm}$ ,  $I_{\text{DD}} \approx 45\ \text{mA}$**

Parameter	Test Conditions <sup>3</sup>	Units	Min	Typ	Max
Conversion Gain <sup>8,9</sup>	LNA +3V	dB	3.1	6.0	6.6
	LNA +5V	dB	4.6	8.0	8.8
Isolation <sup>6</sup>	LO to RF IN	dB	29	32	—
	LO to IF	dB	19	23	—
Reverse Isolation <sup>7</sup>	LNA +3V	dB	30	40	—
VSWR	LO	Ratio	—	1.4:1	—
	RF IN	Ratio	—	1.9:1	2.5:1
	IF	Ratio	—	1.9:1	2.1:1
Input IP <sub>3</sub> <sup>3,4,5</sup>	LNA +3V	dBm	13	17.5	—
	LNA +5V	dBm	21	25	—

3. For IP<sub>3</sub> measurements, RFIN = -24 dBm, this low RF IN level gets amplified through the LNA.
4. For IP<sub>3</sub> measurements, RFIN2 = RFIN1 + 10 MHz, LO = RFIN1—140 MHz.
5. For IP<sub>3</sub> measurements, IP<sub>3</sub> = IMR/2 + PIN.
6. RF IN to IF Isolation is typically 0 dB.
7. Reverse Isolation is measured from IF to RFIN with the IF at -10 dBm, LO at +13 dBm.
8. The amplifier has a normal gain of 12.5 dB, 3V bias and 14.0 dB, 5V bias. Amplifier typical Noise Figure = 1.5 dB.
9.  $N_{\text{T}} = N_{\text{F}_1} + (N_{\text{F}_2} - 1)/G_1$

## Absolute Maximum Ratings<sup>10,11</sup>

Parameter	Absolute Maximum
RF Input Power <sup>12</sup>	+17 dBm
LO Drive Power <sup>12</sup>	+23 dBm
V <sub>DD</sub>	+10 VDC
Current <sup>13</sup>	80 mA
Channel Temperature <sup>14</sup>	+150°C
Operating Temperature	-40°C to +85°C
Storage Temperature	-65°C to +150°C

10. Exceeding any one or combination of these limits may cause permanent damage to this device.
11. M/A-COM does not recommend sustained operation near these survivability limits.
12. Total power for RF and LO ports should not exceed +23 dBm.
13. When pin #2 is used to increase current—see note 8 above.
14. Thermal resistance ( $\theta_{\text{jC}}$ ) = +95°C/W.

## Handling Procedures

Please observe the following precautions to avoid damage:

## Static Sensitivity

Gallium Arsenide Integrated Circuits are sensitive to electrostatic discharge (ESD) and can be damaged by static electricity. Proper ESD control techniques should be used when handling these devices.

## Recommended PCB Configuration

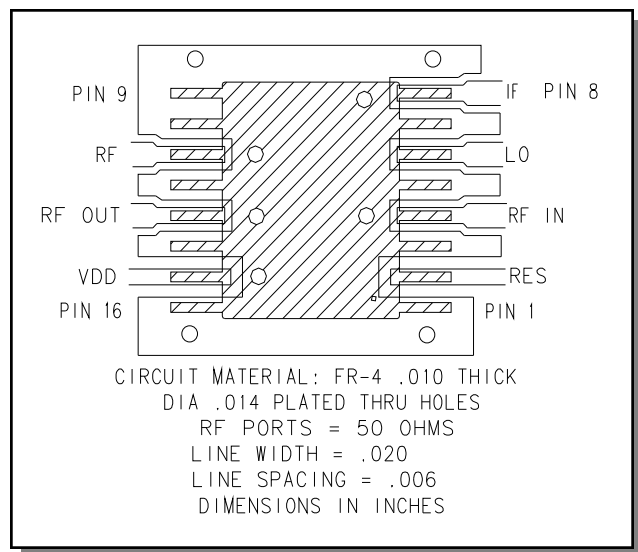

## Spurious Table

Harmonic of LO (n)	4X	-12	-37	-65	-75	-75
	4X	-1.9	-39	-72	-77	-77
	3X	-2.8	-29	-68	-66	-74
	3X	7.1	-30	-70	-77	-75
	2X	7.0	-27	-37	-68	-74
	2X	11.8	-27	-47	-75	-75
	1X	4.5	0	-48	-69	-74
	1X	11.8	0	-58	-76	-76
	0X	N/A	-5	-34	-69	-70
	0X	N/A	-5	-46	-75	-70

Harmonic of RFIN (m)

## External Circuitry Parts <sup>15</sup>

Part	Value	Purpose
C1	47 pF	DC Block
C2	47 pF	By-pass
C3	3.3 pF	LO Port Matching Network
L1	3.9 nH	Tuning
L2	3.0 nH	LO Port Matching Network
L3	12 nH	RF Choke
R1	See Note 16	Optional Current Control
R2	5.1 k Ohms	DC Return
R3	330 Ohms	LO Port Matching Network

15. All external circuitry parts are readily available, low cost surface mount components (.060 in. x .030 in. or .080 in. x .050 in.).

16. Pin 2 allows use of an external resistor to ground for optional higher current. For 20 mA operation, no resistor is used.

For  $I_{DD} \approx 30$  mA, R2 = 43 Ohms

For  $I_{DD} \approx 45$  mA, R2 = 15 Ohms

For  $I_{DD} \approx 60$  mA, R2 = 10 Ohms

The spurious table shows the spurious signals resulting from the mixing of the RFIN and LO input signals, assuming down conversion. The number of dB below the conversion loss level indicates the mixing products. The lower frequency mixing term is shown for two different input levels. The top number is for an RFIN power level of -19 dB; the lower number is for -29 dB. Assuming the LNA gain is approximately 14 dB, the mixer input will see approximately -5 dB and -15 dB.

$$|mF_{RF} - nF_{LO}|, RF = -19 \text{ dB}$$

$$|mF_{RF} - nF_{LO}|, RF = -29 \text{ dB}$$

$$RF = 1850 \text{ MHz}$$

$$LO = 1710 \text{ MHz}$$

## Typical Performance Curves

Gain

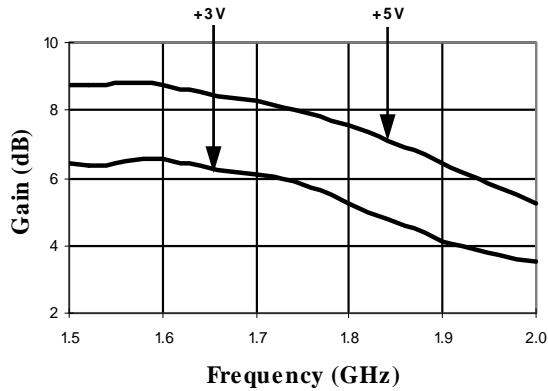

Isolation at +3V

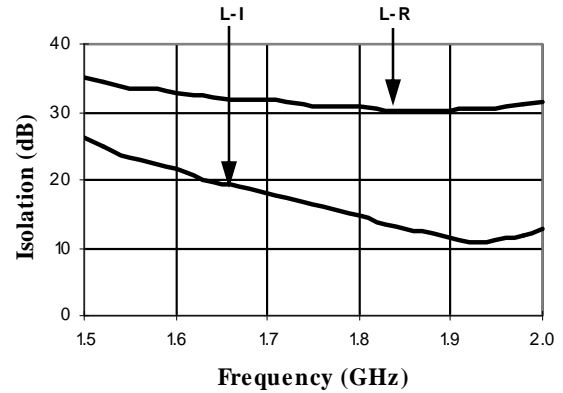

IIP3

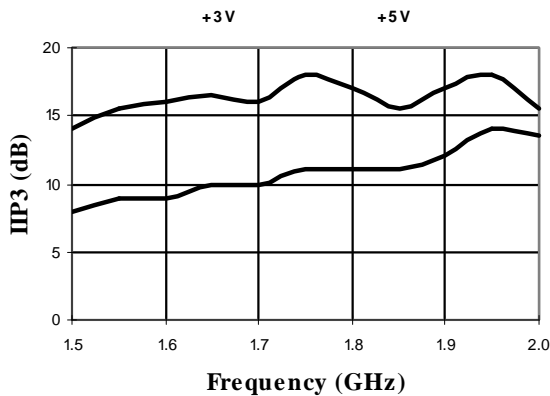

VSWR at +3V

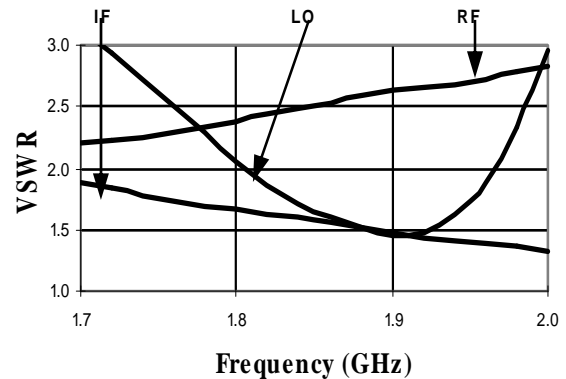

## Lead-Free, QSOP-16<sup>†</sup>

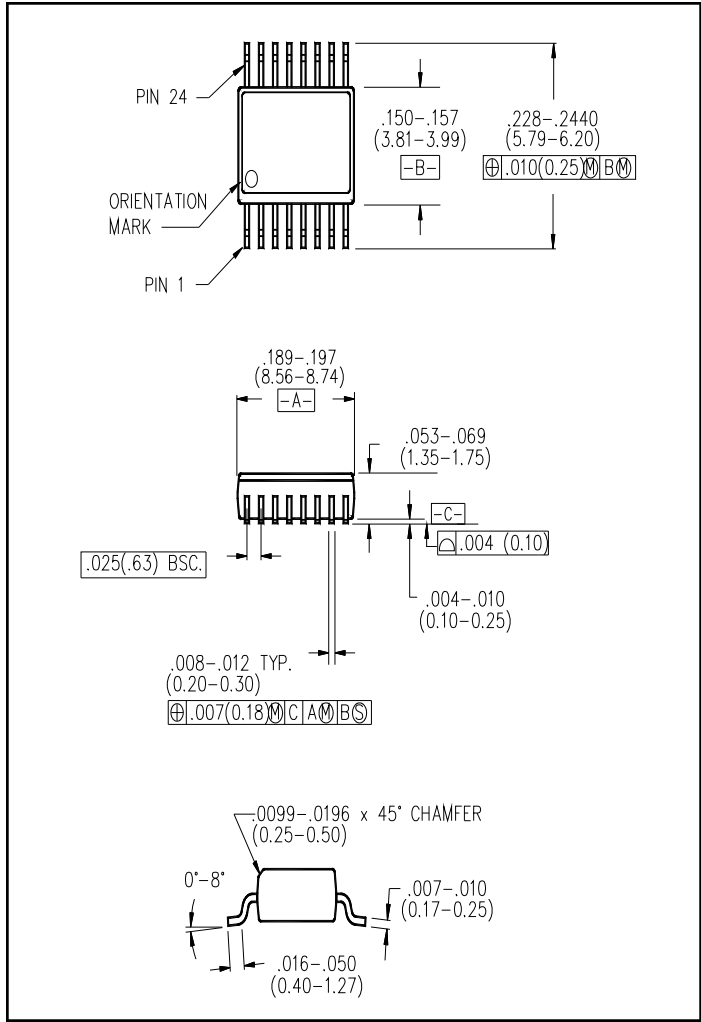

<sup>†</sup> Reference Application Note M538 for lead-free solder reflow recommendations.