

Features

- Low Phase Noise
- Wide Tuning Range
- Divide-by-Two Output
- Integrated Buffer Amplifier
- Excellent Temperature Stability
- +5V Bias
- Lead-Free 5 mm 32-Lead PQFN Package
- Halogen-Free “Green” Mold Compound
- RoHS* Compliant and 260°C Reflow Compatible

Description

The MAOC-009260 is an InGaP HBT-based voltage controlled oscillator for frequency generation. No external matching components are required. This VCO is easily integrated into a phase lock loop using the divide-by-two output. The extremely low phase noise makes this part ideal for many radio applications including high capacity digital radios.

The MAOC-009260 primary applications are Point-to-Point Radio, Point-to-Multipoint Radio, Communications Systems, and Low Phase Noise applications.

The 5 mm PQFN package has a lead-free finish that is RoHS compliant and compatible with a 260°C reflow temperature. The package also features low lead inductance and an excellent thermal path.

Ordering Information¹

Part Number	Package
MAOC-009260-TR0500	500 piece reel
MAOC-009260-TR1000	1000 piece reel
MAOC-009260-SMB003	Sample Board

1. Reference Application Note M513 for reel size information.

Block Diagram

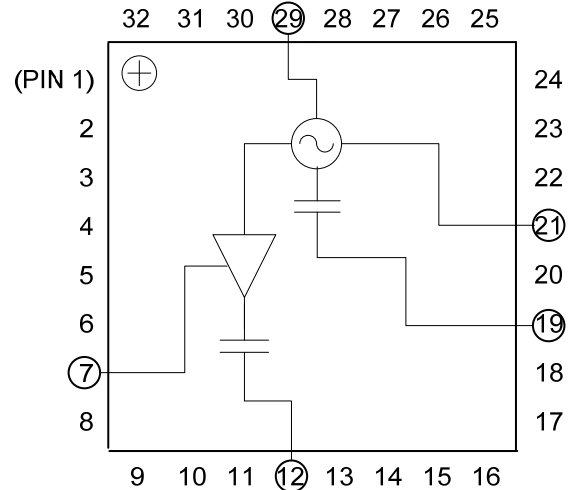

Pin Designations²

Pin	Function	Pin	Function
1	N/C	17	N/C
2	N/C	18	N/C
3	N/C	19	RF
4	N/C	20	N/C
5	N/C	21	V _{CC}
6	N/C	22	N/C
7	V _{BUFFER}	23	N/C
8	N/C	24	N/C
9	N/C	25	N/C
10	N/C	26	N/C
11	N/C	27	N/C
12	RF/2	28	N/C
13	N/C	29	V _{TUNE}
14	N/C	30	N/C
15	N/C	31	N/C
16	N/C	32	N/C

2. The exposed pad centered on the package bottom must be connected to RF and DC ground. Connecting all N/C pins to RF/DC Ground in the layout is also recommended.

* Restrictions on Hazardous Substances, European Union Directive 2002/95/EC.

ADVANCED: Data Sheets contain information regarding a product M/A-COM Technology Solutions is considering for development. Performance is based on target specifications, simulated results, and/or prototype measurements. Commitment to develop is not guaranteed.
PRELIMINARY: Data Sheets contain information regarding a product M/A-COM Technology Solutions has under development. Performance is based on engineering tests. Specifications are typical. Mechanical outline has been fixed. Engineering samples and/or test data may be available. Commitment to produce in volume is not guaranteed.

• **North America** Tel: 800.366.2266 • **Europe** Tel: +353.21.244.6400
 • **India** Tel: +91.80.43537383 • **China** Tel: +86.21.2407.1588
 Visit www.macomtech.com for additional data sheets and product information.

M/A-COM Technology Solutions Inc. and its affiliates reserve the right to make changes to the product(s) or information contained herein without notice.

Voltage Controlled Oscillator 6.1 – 7.0 GHz

Rev. V2

Electrical Specifications: $T_A = +25^\circ\text{C}$, $V_{CC} = V_{BUFFER} = 5.0\text{ V}^3$, $Z_0 = 50\ \Omega$

Parameter	Test Conditions	Units	Min.	Typ.	Max.
Output Power	RF Port, 6.1 - 7.0 GHz RF/2 Port, 3.05 - 3.5 GHz	dBm	9 2	12 5	—
SSB Phase Noise $V_{CC}=V_{BUFFER}=V_{TUNE}=5\text{V}$	RF Port, 10 KHZ Offset RF Port, 100 KHZ Offset	dBc/Hz	—	-92 -117	—
Harmonics/Subharmonics $V_{CC}=V_{BUFFER}=V_{TUNE}=5\text{V}$	RF Port, $\frac{1}{2} F_0$ RF Port, $2 F_0$	dBc	—	-26 -21	—
Pulling (Sensitivity to Match) $V_{CC}=V_{BUFFER}=V_{TUNE}=5\text{V}$	RF Port, VSWR = 1.95:1 to 2.25:1	MHz pk-pk	—	7.5	—
Pushing (Sensitivity to Supply Voltage)	RF Port, $V_{TUNE} = 5\text{ V}$ RF/2 Port, $V_{TUNE} = 5\text{ V}$	MHz/V	—	6 3	—
Frequency Drift Rate (Sensitivity to Temperature)	RF Port, 6.1 - 7.0 GHz RF/2 Port, 3.05 - 3.5 GHz	MHz/ $^\circ\text{C}$	—	0.8 0.4	—
Output Return Loss	RF Port, 6.1 - 7.0 GHz RF/2 Port, 3.05 - 3.5 GHz	dB	—	4 9	—
Tuning Sensitivity @ RF Port	$V_{TUNE} = 5\text{ V}$	GHz/V	—	0.13	—
Supply Current	$I_{TOTAL} (I_{CC} + I_{BUFFER})$ I_{CC} I_{BUFFER}	mA	— — —	185 165 20	205 175 30
Tune Voltage	V_{TUNE}	V	1	—	13
Tuning Current Leakage	$V_{TUNE} = 13\text{ V}$	μA	—	5	10

3. VCO can operate over the 4.75 V to 5.25 V supply voltage range.

Absolute Maximum Ratings ^{4,5,6}

Parameter	Absolute Maximum
Supply Voltage (V_{CC} & V_{BUFFER})	+5.5 Vdc
V_{TUNE}	0 to +15 Vdc
Storage Temperature	-55 $^\circ\text{C}$ to +150 $^\circ\text{C}$
Operating Temperature	-40 $^\circ\text{C}$ to +85 $^\circ\text{C}$
Case Temperature (T_C) (measured @ exposed pad)	+100 $^\circ\text{C}$
Junction Temperature ⁷	+135 $^\circ\text{C}$

- Exceeding any one or combination of these limits may cause permanent damage to this device.
- M/A-COM Technology Solutions does not recommend sustained operation near these survivability limits.
- Operating at nominal conditions with $T_J \leq +135^\circ\text{C}$ will ensure MTBF > 2.5×10^6 hours.
- Junction Temperature (T_J) = $T_C + \Theta_{jc} * (V * I)$
Typical thermal resistance (Θ_{jc}) = 35 $^\circ\text{C/W}$.
a) For $T_C = 25^\circ\text{C}$, $T_J = 57^\circ\text{C}$ @ 5 V, 185 mA
b) For $T_C = 85^\circ\text{C}$, $T_J = 118^\circ\text{C}$ @ 5 V, 190 mA

Handling Procedures

Please observe the following precautions to avoid damage:

Static Sensitivity

Gallium Arsenide Integrated Circuits are sensitive to electrostatic discharge (ESD) and can be damaged by static electricity. Proper ESD control techniques should be used when handling these devices.



ESD Rating: Class 1A

2

ADVANCED: Data Sheets contain information regarding a product M/A-COM Technology Solutions is considering for development. Performance is based on target specifications, simulated results, and/or prototype measurements. Commitment to develop is not guaranteed.

PRELIMINARY: Data Sheets contain information regarding a product M/A-COM Technology Solutions has under development. Performance is based on engineering tests. Specifications are typical. Mechanical outline has been fixed. Engineering samples and/or test data may be available. Commitment to produce in volume is not guaranteed.

• **North America** Tel: 800.366.2266 • **Europe** Tel: +353.21.244.6400
• **India** Tel: +91.80.43537383 • **China** Tel: +86.21.2407.1588

Visit www.macomtech.com for additional data sheets and product information.

M/A-COM Technology Solutions Inc. and its affiliates reserve the right to make changes to the product(s) or information contained herein without notice.

Typical Performance Curves: $V_{CC} = V_{BUFFER} = 5V$, $T_A = +25^\circ C$ (unless otherwise indicated)

Output Frequency vs. Tuning Voltage - RF Port

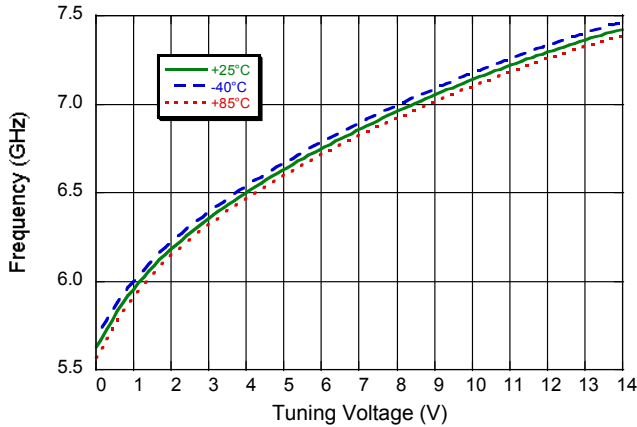

Output Frequency vs. Tuning Voltage - RF/2 Port

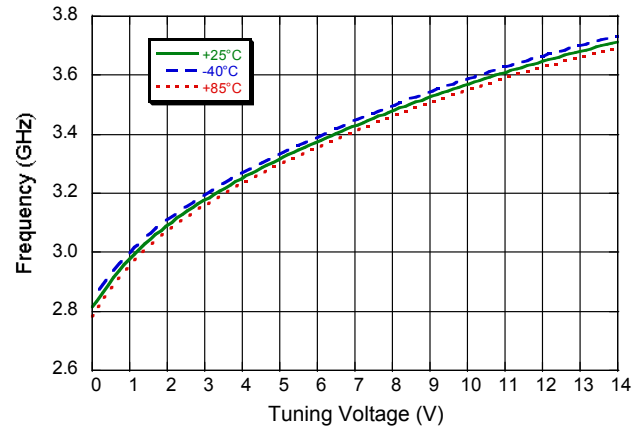

Output Frequency vs. Tuning / Supply Voltage - RF Port

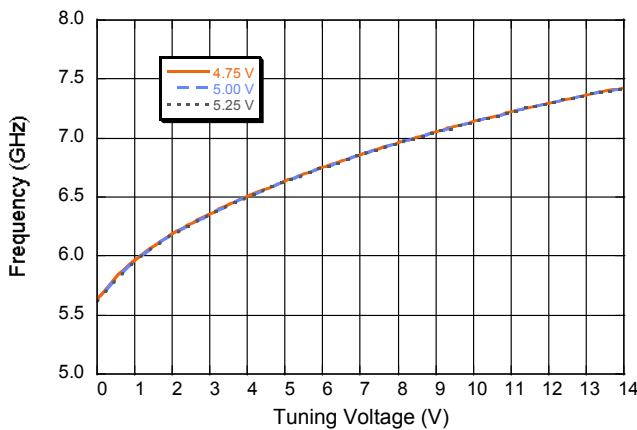

Output Frequency vs. Tuning / Supply Voltage - RF/2 Port

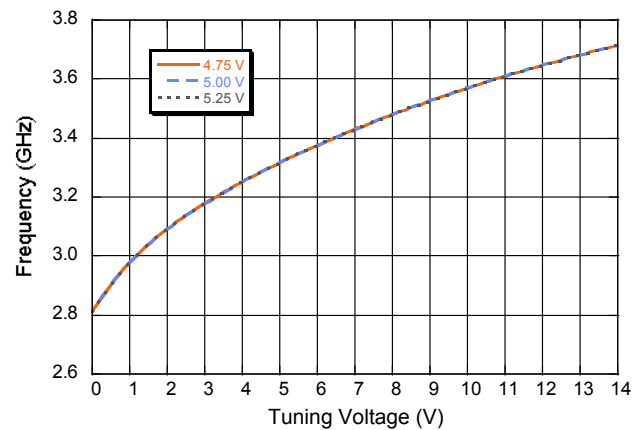

Output Power vs. Tuning Voltage - RF Port

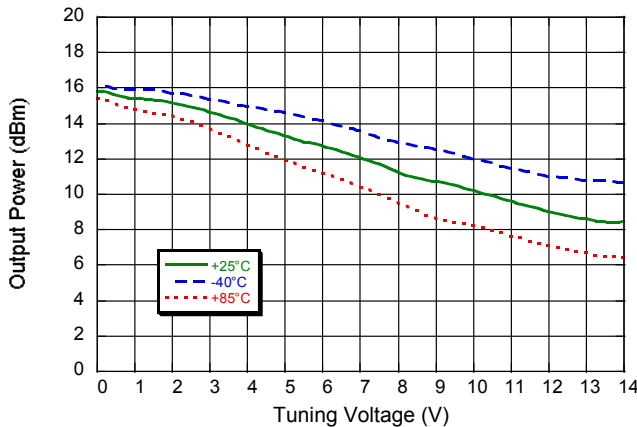

Output Power vs. Tuning Voltage - RF/2 Port

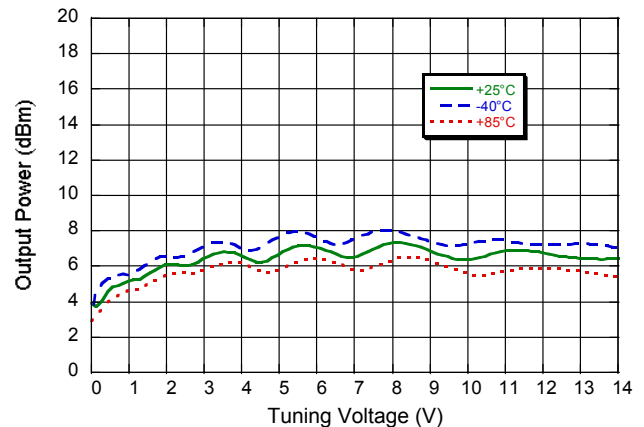

ADVANCED: Data Sheets contain information regarding a product M/A-COM Technology Solutions is considering for development. Performance is based on target specifications, simulated results, and/or prototype measurements. Commitment to develop is not guaranteed.
PRELIMINARY: Data Sheets contain information regarding a product M/A-COM Technology Solutions has under development. Performance is based on engineering tests. Specifications are typical. Mechanical outline has been fixed. Engineering samples and/or test data may be available. Commitment to produce in volume is not guaranteed.

• **North America** Tel: 800.366.2266 • **Europe** Tel: +353.21.244.6400
 • **India** Tel: +91.80.43537383 • **China** Tel: +86.21.2407.1588
 Visit www.macomtech.com for additional data sheets and product information.

M/A-COM Technology Solutions Inc. and its affiliates reserve the right to make changes to the product(s) or information contained herein without notice.

Typical Performance Curves: $V_{CC} = V_{BUFFER} = 5V$, $T_A = +25^\circ C$ (unless otherwise indicated)

Frequency Sensitivity vs. Tuning Voltage - RF Port

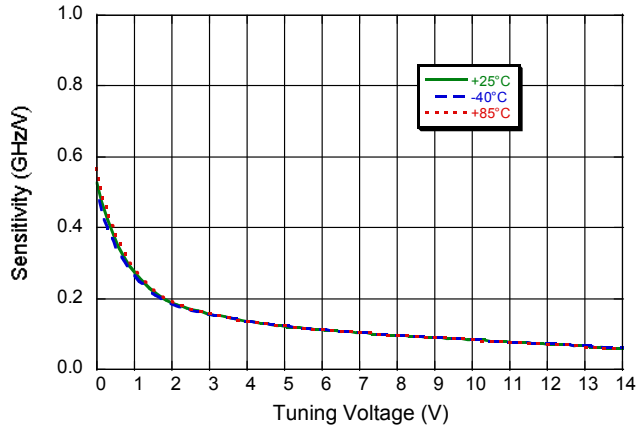

Frequency Sensitivity vs. Tuning Voltage - RF/2 Port

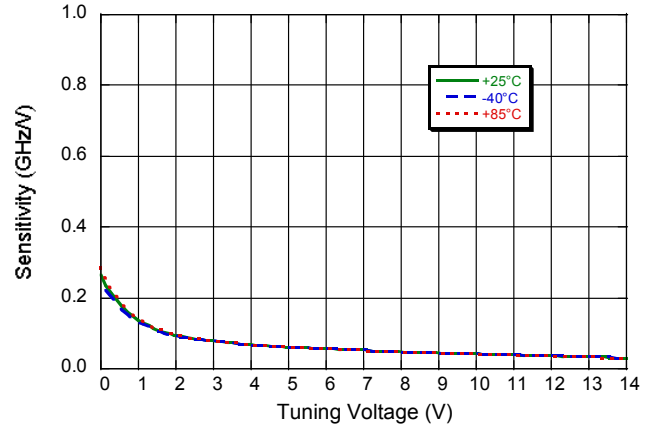

**Single Side Band Phase Noise vs. Tuning Voltage
RF Port**

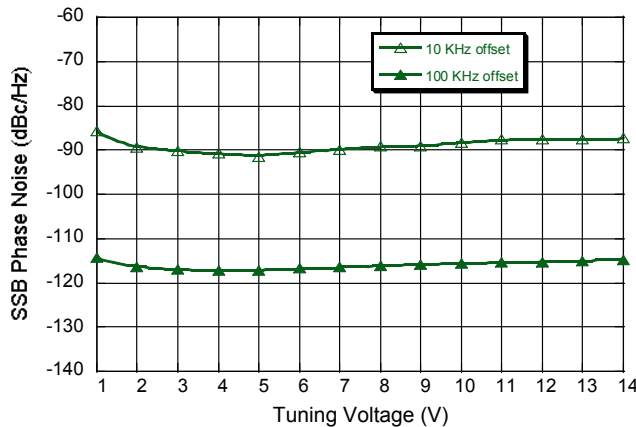

**Single Side Band Phase Noise vs. Frequency Offset
RF Port ($V_{TUNE} = 5V$)**

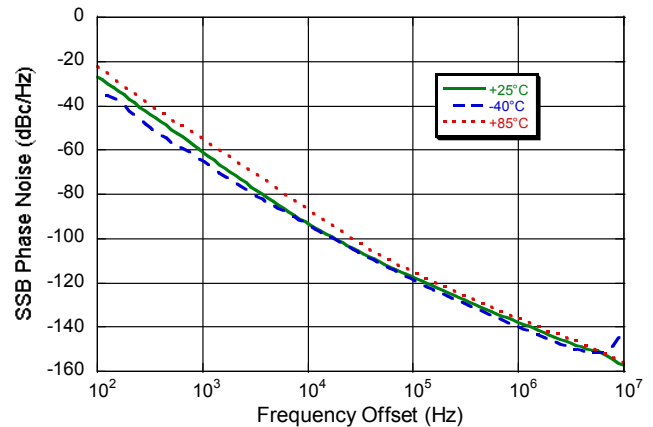

Sample Board

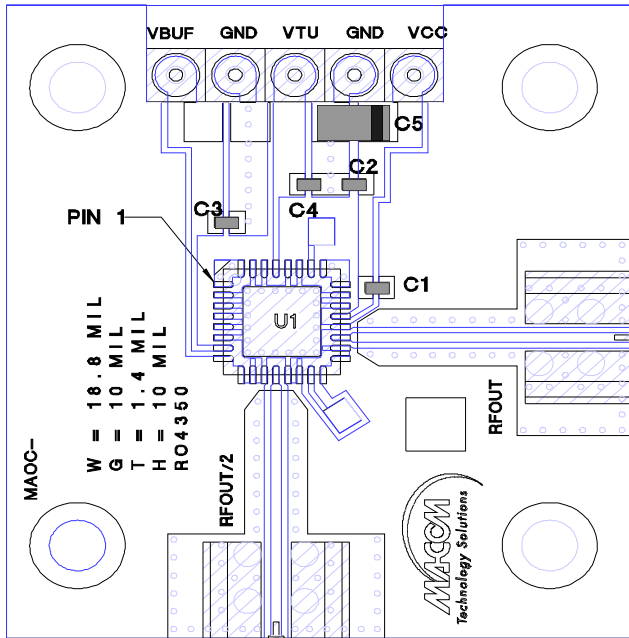

Parts List

Component	Value	Case Size
C1	100 pF	0402
C2, C3, C4	0.1 μ F	0402
C5	10 μ F Tantalum	1206

Lead-Free 5 mm 32-Lead PQFN[†]

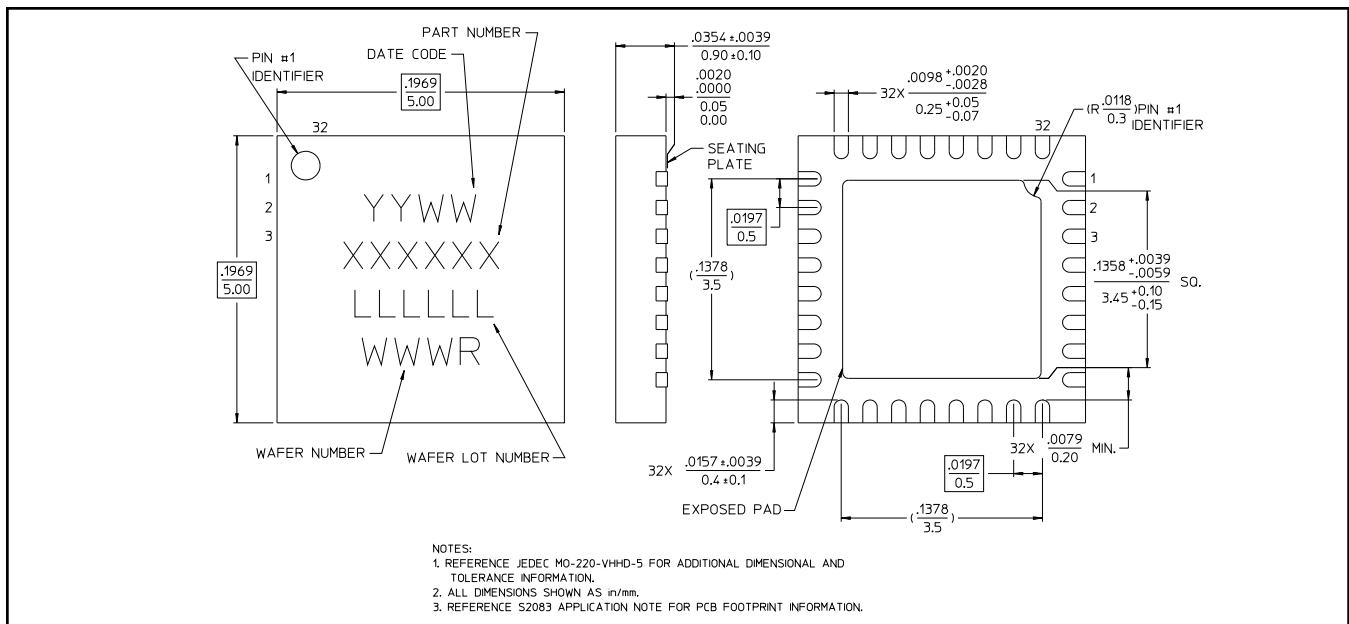

[†] Reference Application Note S2083 for lead-free solder reflow recommendations.
 Meets JEDEC moisture sensitivity level 1 requirements.
 Plating is 100% matte tin over copper.