

Specifications are subject to change without notice.

DESCRIPTION

MGFS38E3336 is a GaAs RF amplifier designed for WiMAX CPE.

FEATURES

- InGaP HBT Device
- 5V Operation
- 28.5dBm Linear Output Power (64QAM, EVM=2.5%)
- 35dB Linear Gain
- Integrated Output Power Detector
- Integrated 1-bit Step Attenuator
- Surface Mount Package
- RoHS Compliant Package

APPLICATIONS

IEEE802.16-2004
 IEEE802.16e-2005

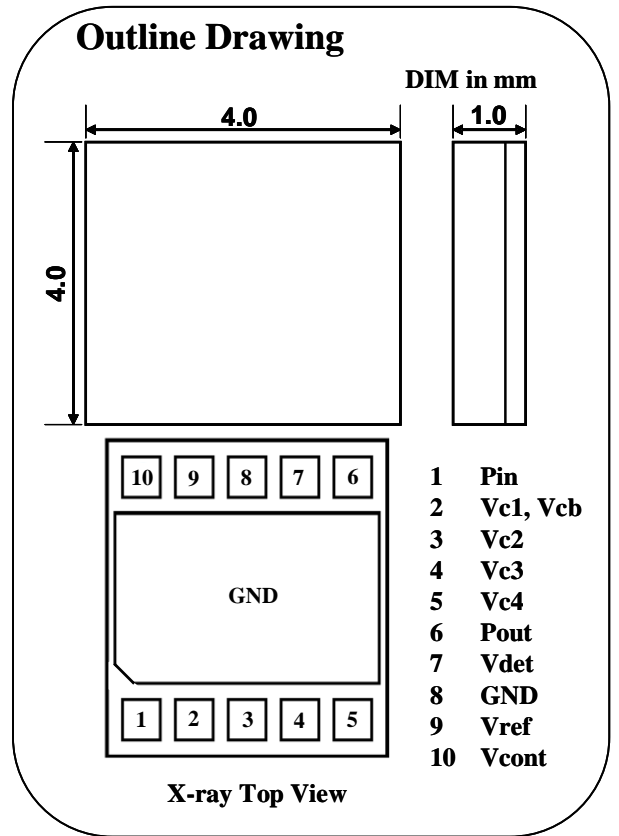

FUNCTIONAL BLOCK DIAGRAM

www.BDTIC.com/MITSUBISHI

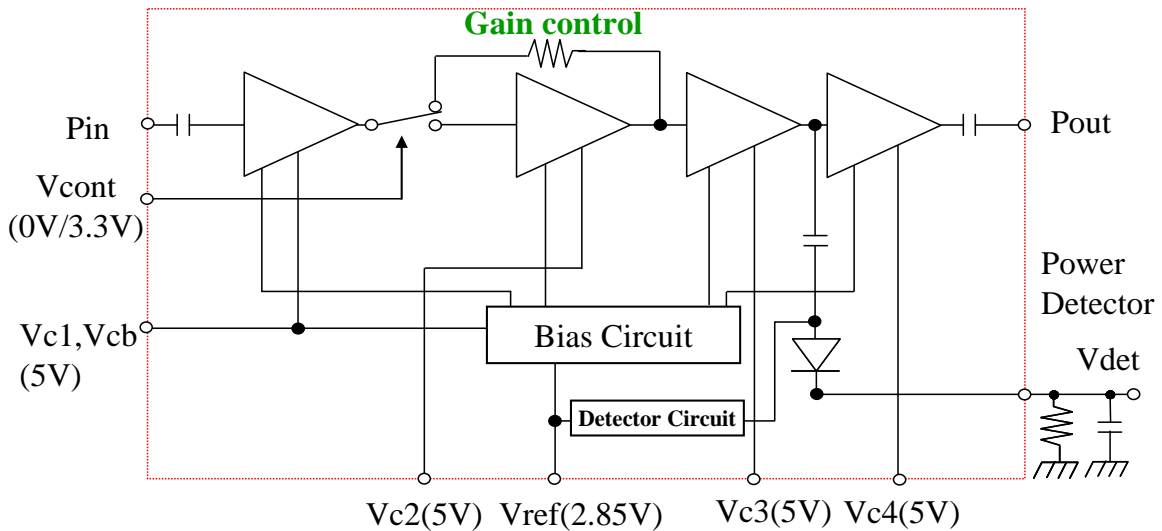

Mitsubishi Electric Corporation puts the maximum effort into making semiconductor products better and more reliable, but there is always the possibility that trouble may occur with them. Trouble with semiconductors may lead to personal injury, fire or property damage. Remember to give due consideration to safety when making your circuit designs, with appropriate measures such as (i)placement of substitutive, auxiliary, circuits, (ii)use of non-flammable material or (iii)prevention against any malfunction or mishap.

ABSOLUTE MAXIMUM RATINGS

Symbol	Parameter	Conditions	Value		Unit
			Min.	Max.	
Vc1,Vc2,Vc3, Vc4,Vcb	Collector Supply Voltage	-	-	8	V
Vref	Reference Voltage	-	-	3	V
Vcont	ATT Control Voltage	-	-	3.5	V
Ic1+Icb	Operation Current	-		100	mA
Ic2				100	mA
Ic3				300	mA
Ic4				1000	mA
Pin	Input Power	-	-	3	dBm
Tc(op)	Operation Temperature	Pout≤28.5dBm	-40	+85	°C
Tstg	Storage Temperature	-	-40	+125	°C
-	Duty Cycle	-	-	50	%

*NOTE : Ta=25°C unless otherwise noted, Zin=Zout=50Ω
 Each maximum rating is guaranteed independently.
 Please take care that MGFS38E3336 is operated under these conditions at the worst case on your terminal.

ELECTRICAL CHARACTERISTICS

Symbol	Parameter	Test Conditions	Value			Unit
			Min	Typ	Max	
f	Frequency		3300		3600	MHz
Gp	Gain	Vc1=Vc2=Vc3=Vc4=5V, Vref=2.85V, Vcont=0V Pout=28.5dBm 64QAM OFDM Modulation Duty Cycle ≤ 50%		36.0		dB
EVM	EVM			2.5		%
Vdet	Power Detector Voltage			1.8		V
ATT	Control Gain Step			23		dB
Ict	Operating Current			950		mA

*NOTE : Ta=25°C unless otherwise noted, Zin=Zout=50Ω

**ATT=Gain(@Vcont=0V)−Gain(@Vcont=3.3V)

MOISTURE SENSITIVITY LEVEL : LEVEL3

Specifications are subject to change without notice.

PERFORMANCE DATA (WiMAX OFDM 64QAM signal input)

Vc=5V, Vref=2.85V, Vcont=0V, Duty Cycle=50%, Ta=25deg.C

Gain vs. Output Power

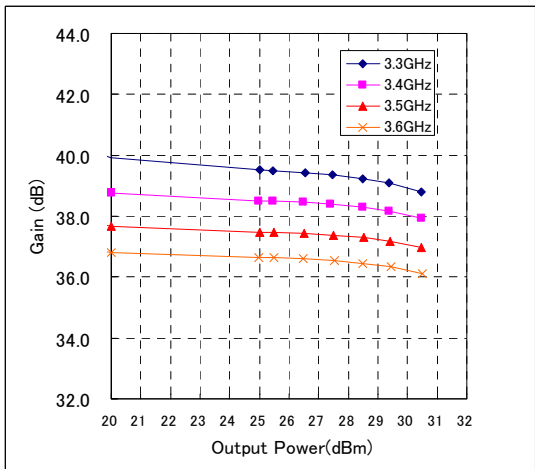

Operating Current vs. Output Power

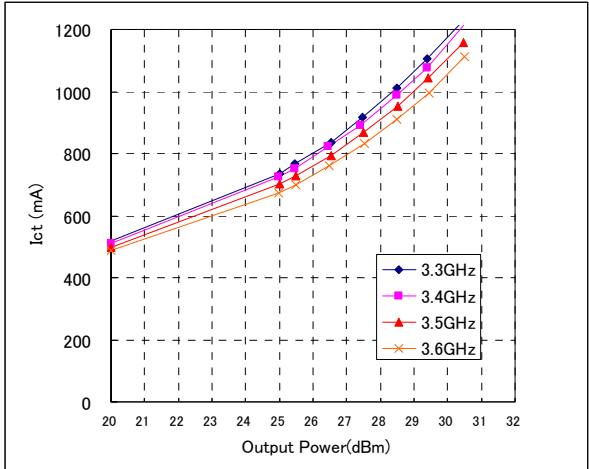

EVM vs. Output Power

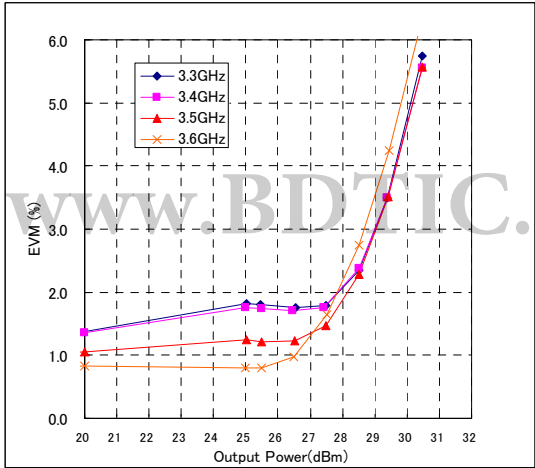

Detector Voltage vs. Output Power

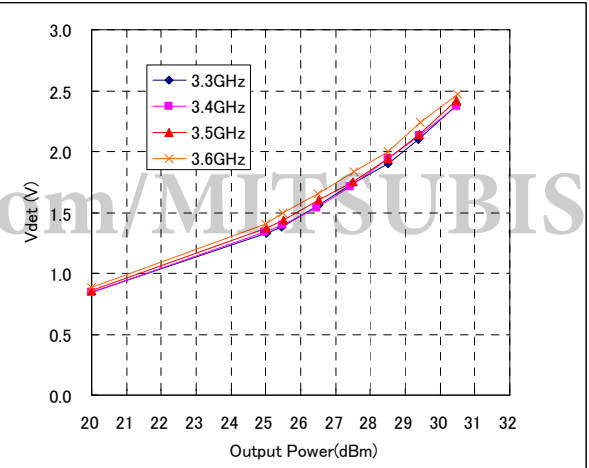

ACP Characteristics

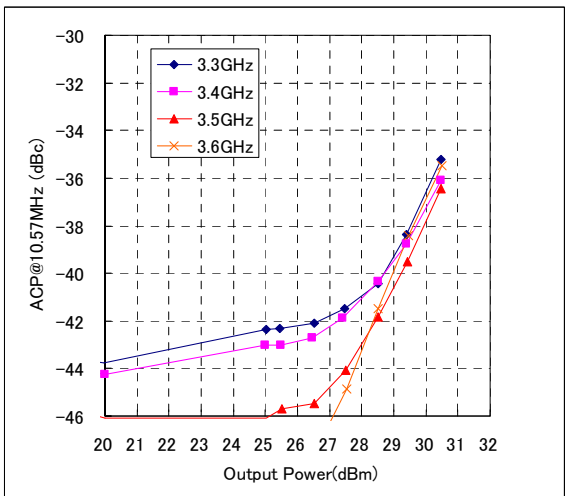
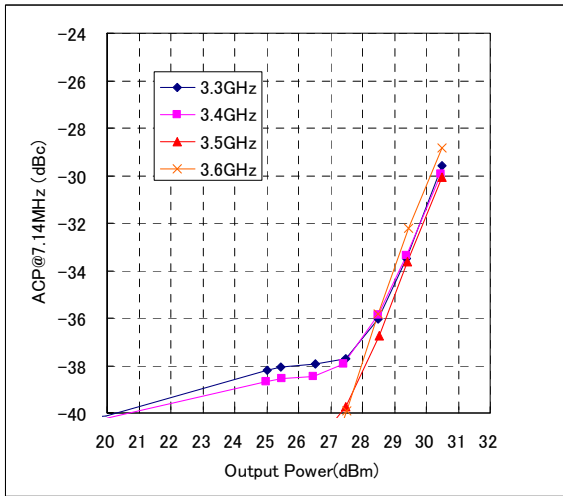

Specifications are subject to change without notice.

Attenuation Performance

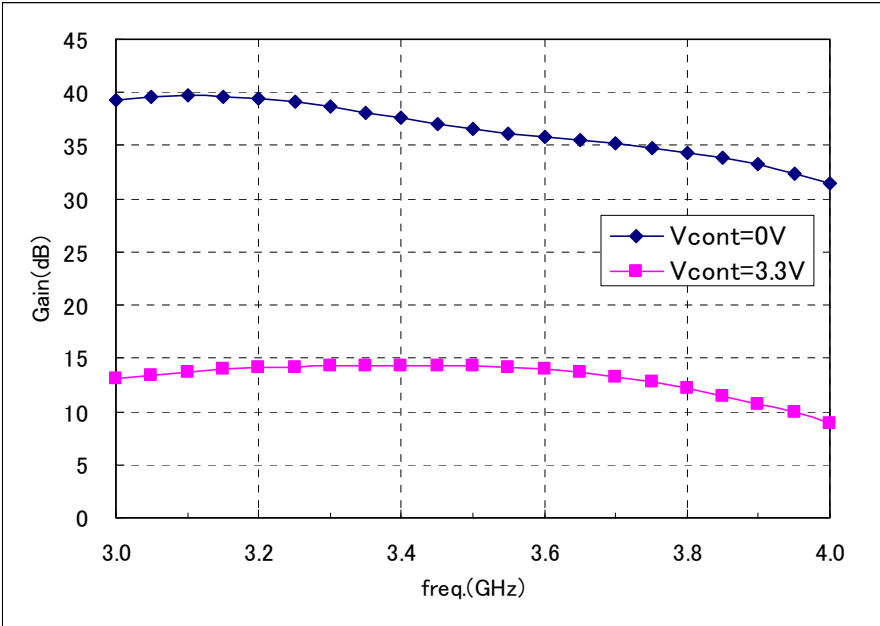

www.BDTIC.com/MITSUBISHI

Specifications are subject to change without notice.

$V_c=5V$, $V_{ref}=2.85V$, $V_{cont}=0V$, Duty Cycle=50%, $f=3.3GHz$

Gain vs. Output Power

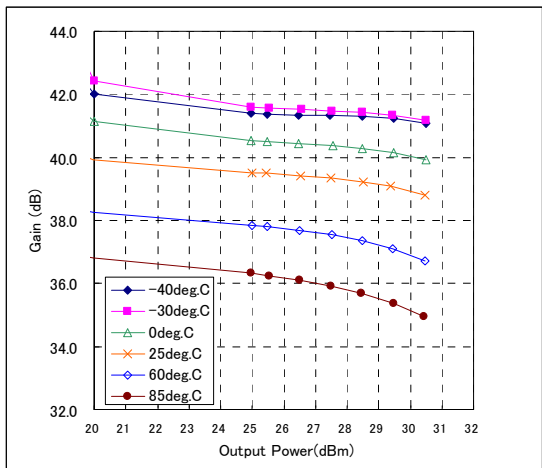

Operating Current vs. Output Power

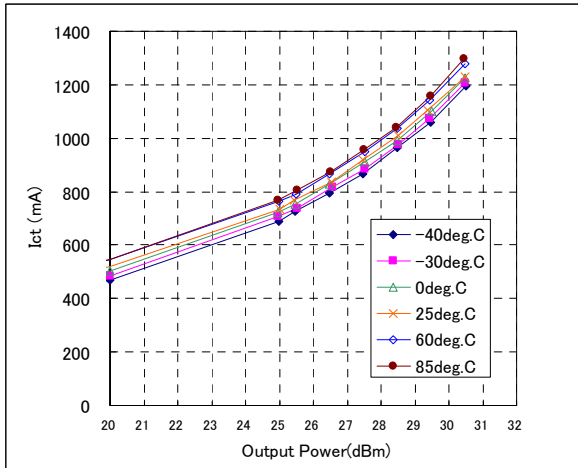

EVM vs. Output Power

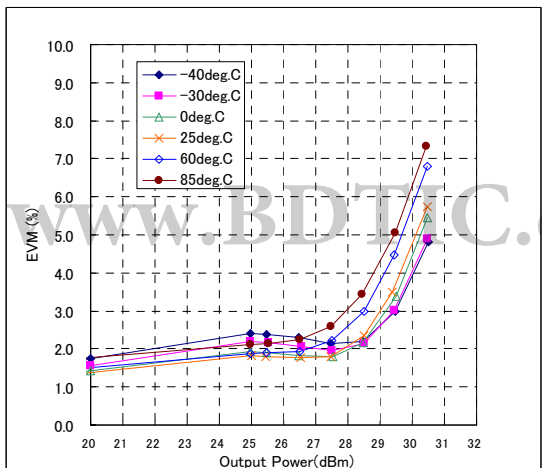

Detector Voltage vs. Output Power

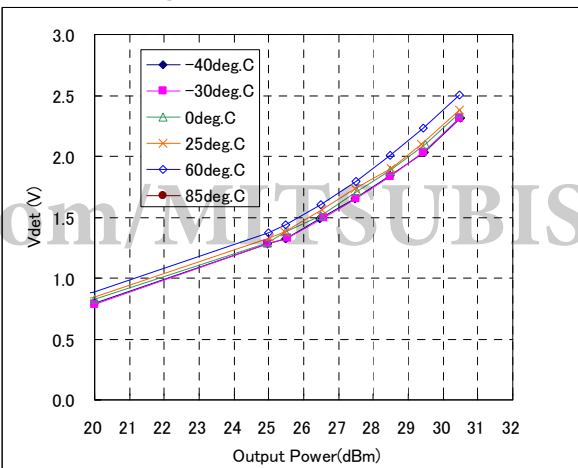

ACP Characteristics

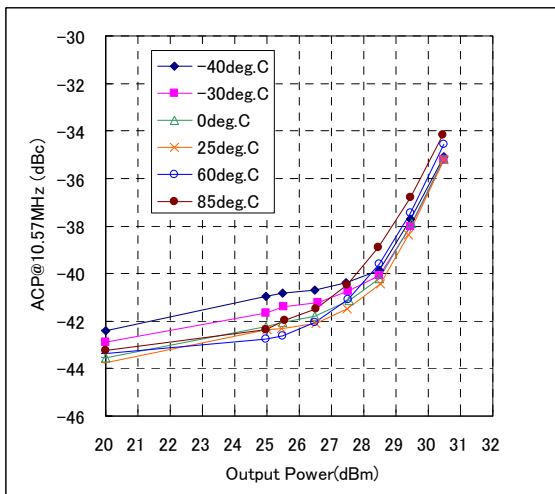
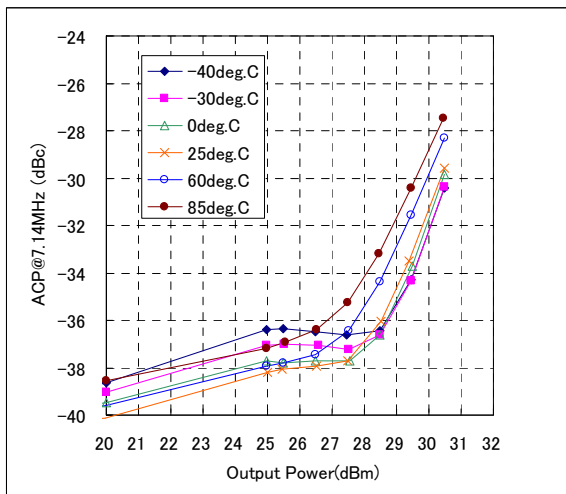

Specifications are subject to change without notice.

$V_c=5V$, $V_{ref}=2.85V$, $V_{cont}=0V$, Duty Cycle=50%, $f=3.4GHz$

Gain vs. Output Power

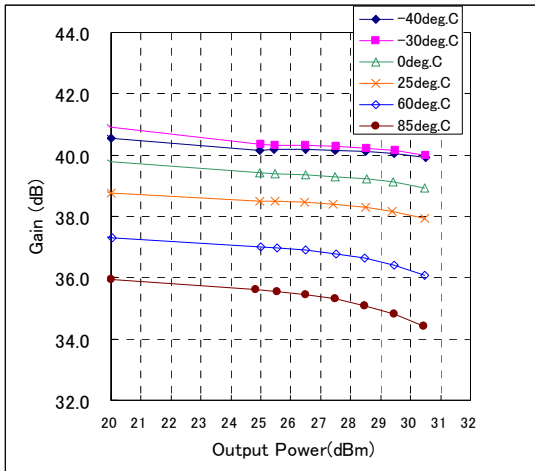

Operating Current vs. Output Power

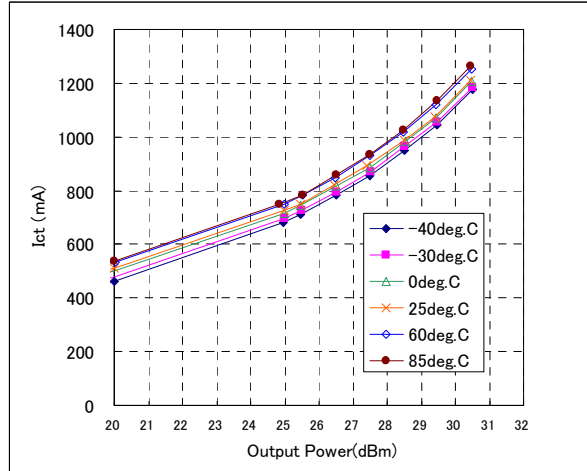

EVM vs. Output Power

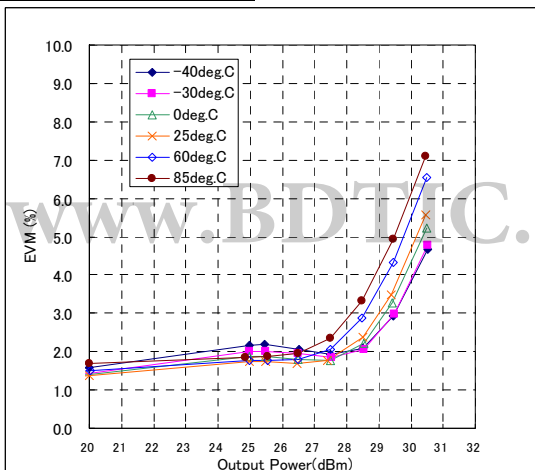

Detector Voltage vs. Output Power

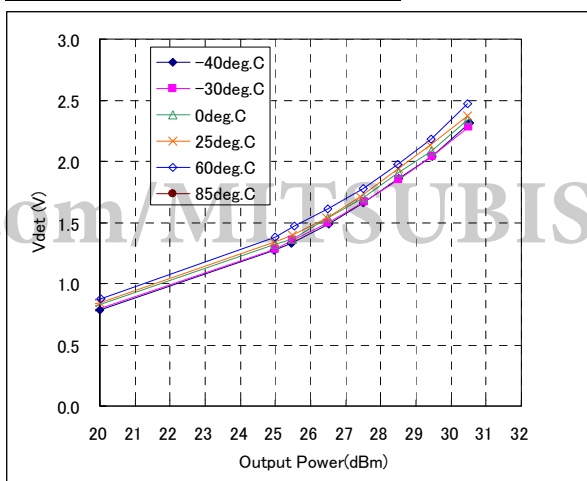

ACP Characteristics

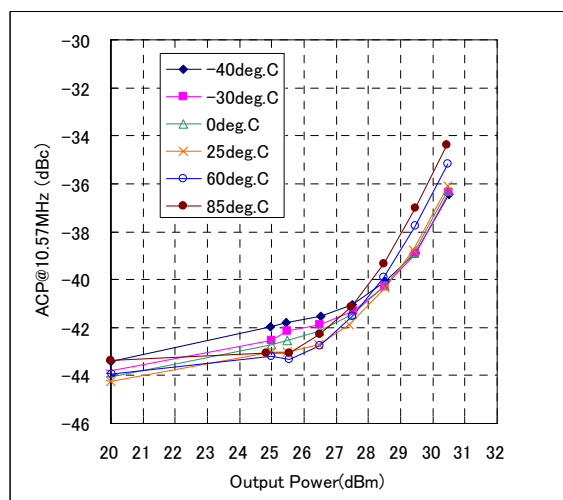
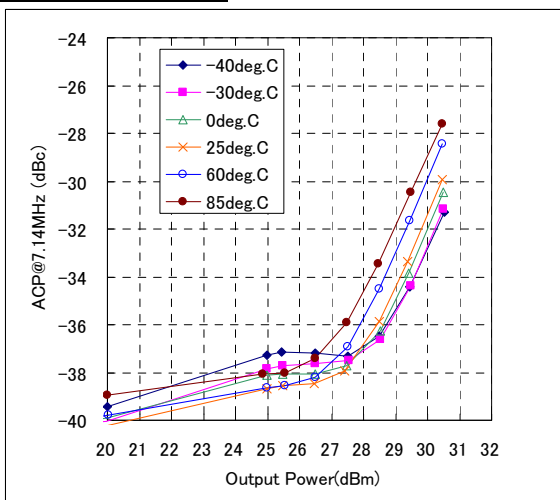

Specifications are subject to change without notice.

Vc=5V, Vref=2.85V, Vcont=0V, Duty Cycle=50%, f=3.5GHz

Gain vs. Output Power

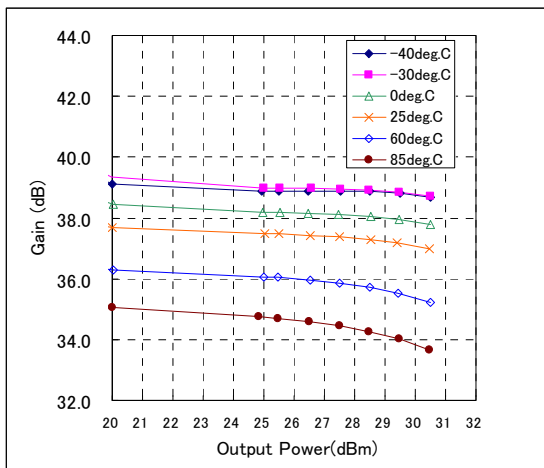

Operating Current vs. Output Power

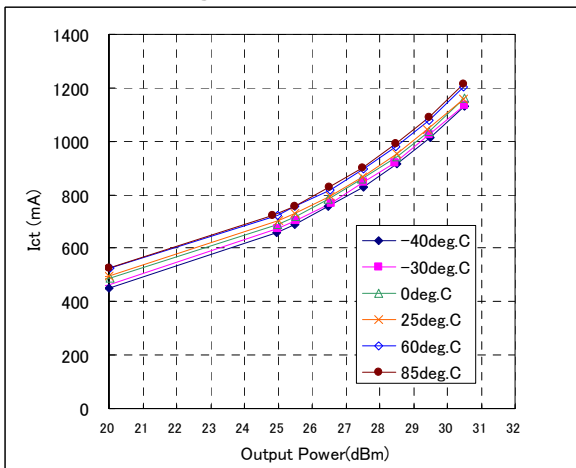

EVM vs. Output Power

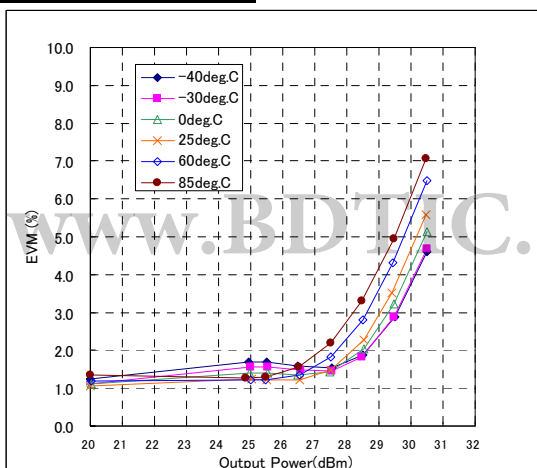

Detector Voltage vs. Output Power

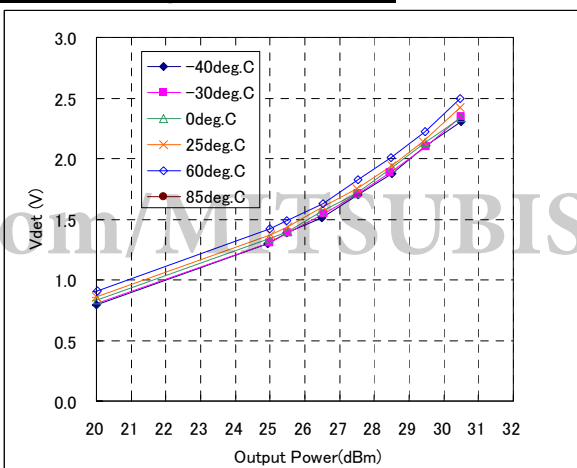

ACP Characteristics

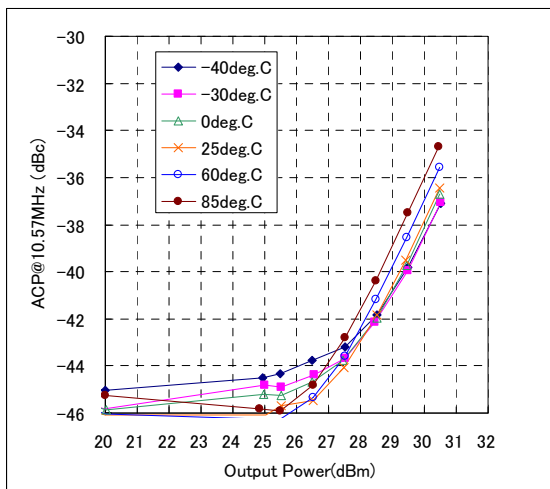
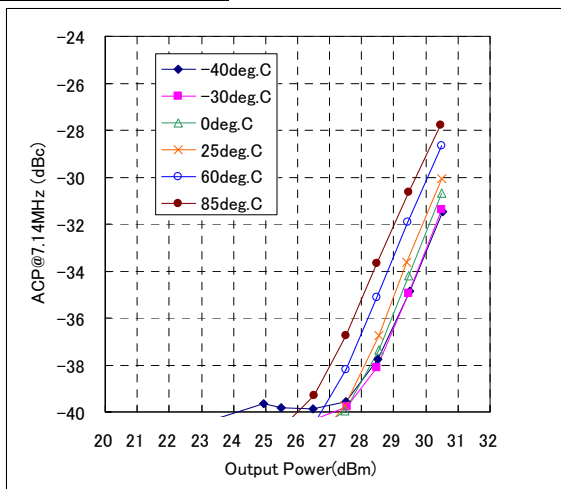

Specifications are subject to change without notice.

$V_c=5V$, $V_{ref}=2.85V$, $V_{cont}=0V$, Duty Cycle=50%, $f=3.6GHz$

Gain vs. Output Power

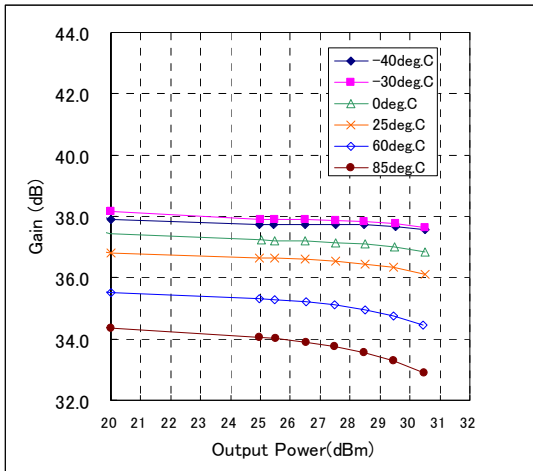

Operating Current vs. Output Power

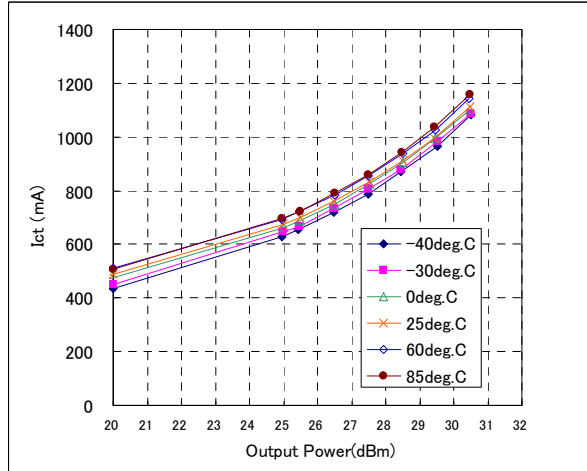

EVM vs. Output Power

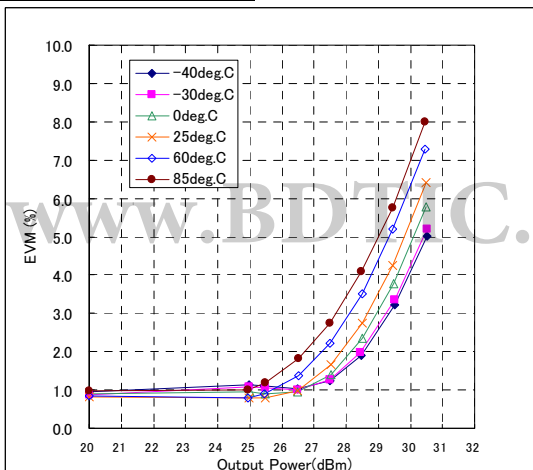

Detector Voltage vs. Output Power

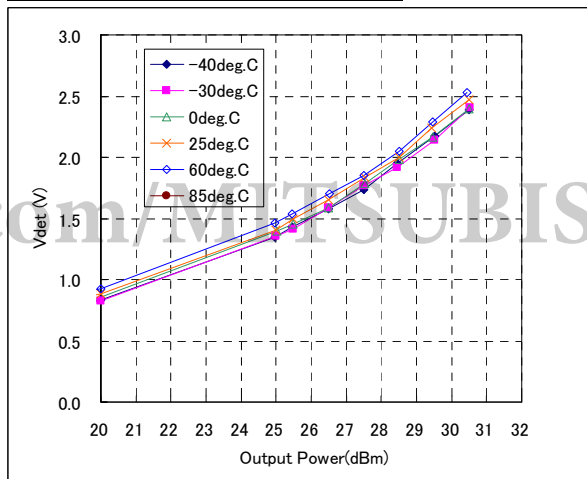

ACP Characteristics

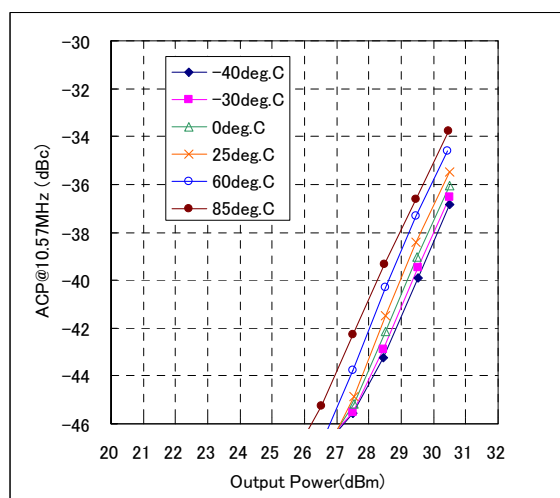
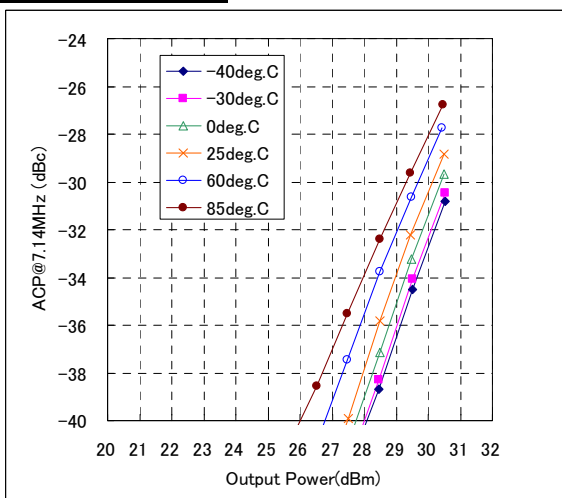

Specifications are subject to change without notice.

PERFORMANCE DATA (WiMAX OFDM 64QAM signal input)

Vc=5V, Vref=2.8V, Vcont=0V, Duty Cycle=50%, Ta=25deg.C

Gain vs. Output Power

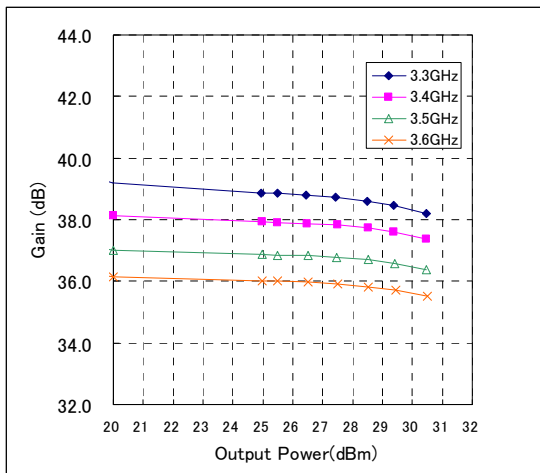

Operating Current vs. Output Power

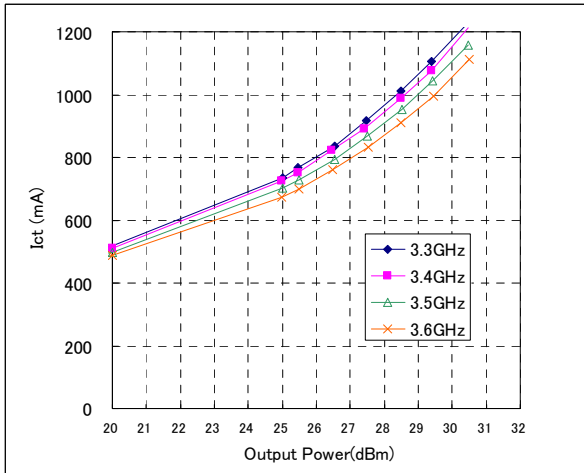

EVM vs. Output Power

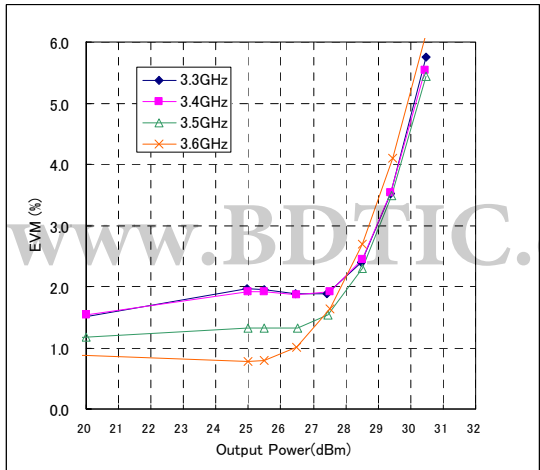

Detector Voltage vs. Output Power

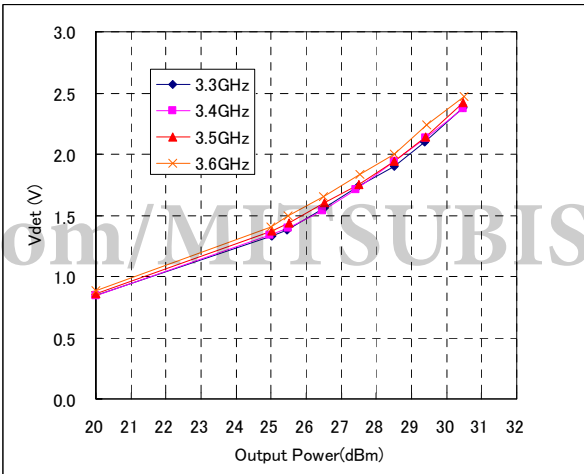

ACP Characteristics

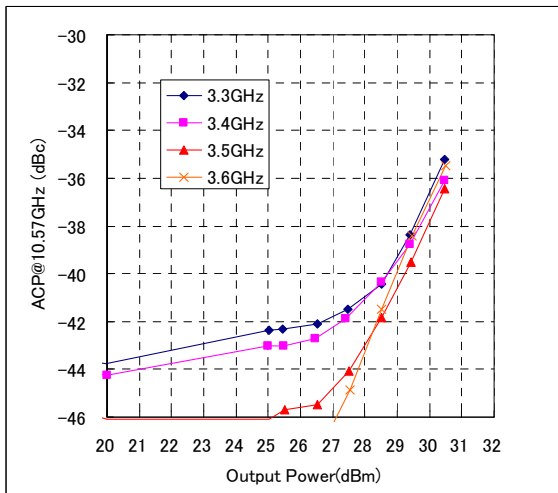
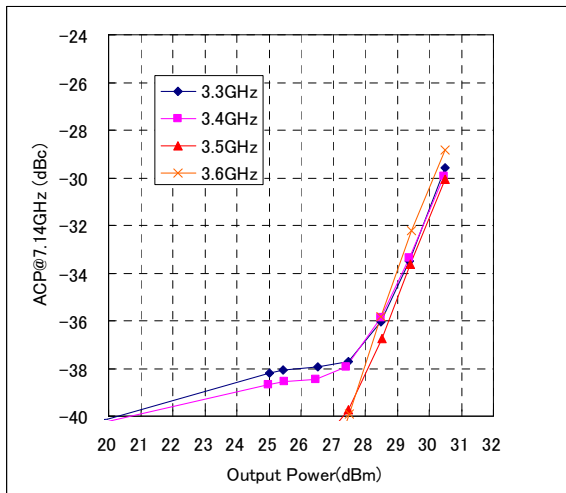

Specifications are subject to change without notice.

$V_c=5V$, $V_{ref}=2.8V$, $V_{cont}=0V$, Duty Cycle=50%, $f=3.3GHz$

Gain vs. Output Power

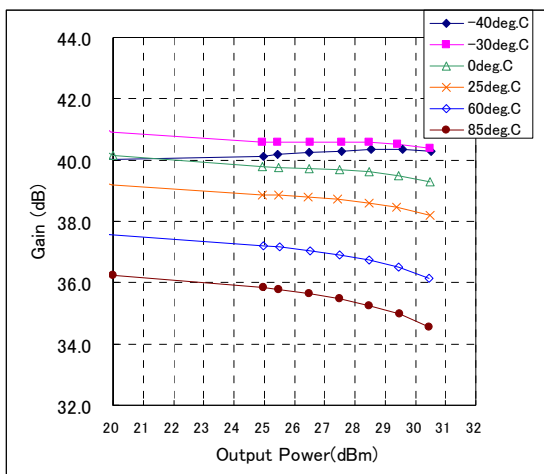

Operating Current vs. Output Power

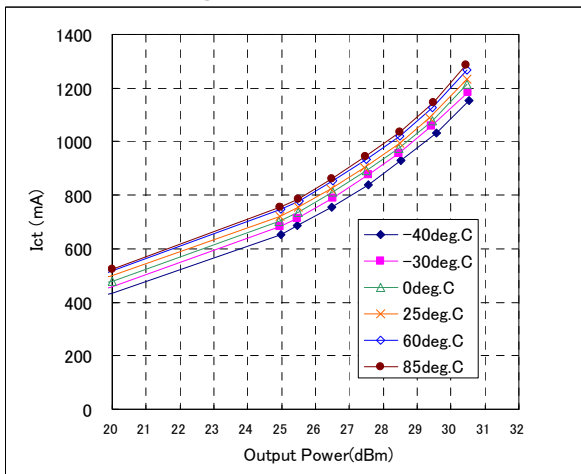

EVM vs. Output Power

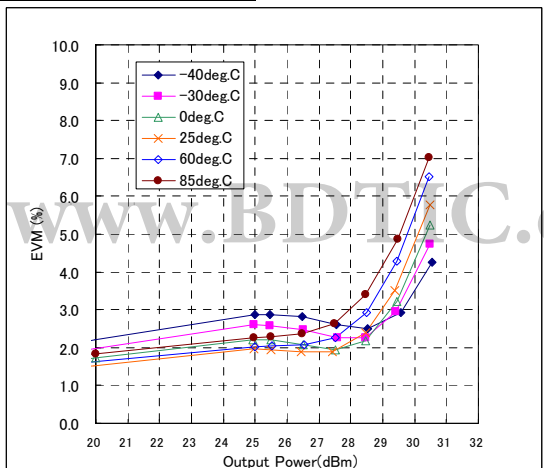

Detector Voltage vs. Output Power

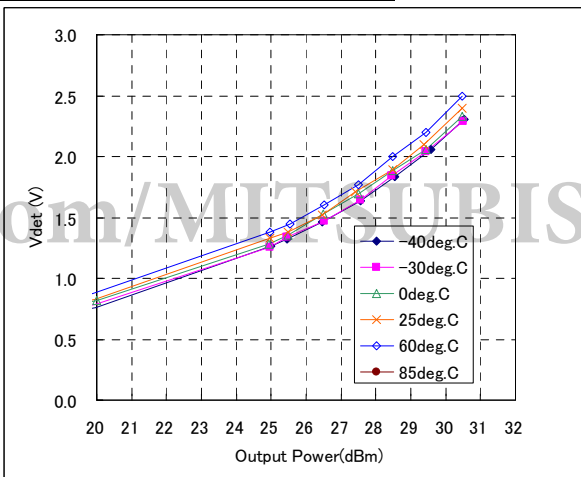

ACP Characteristics

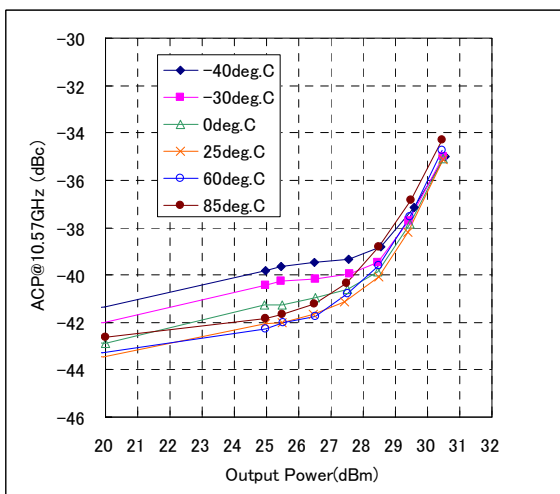
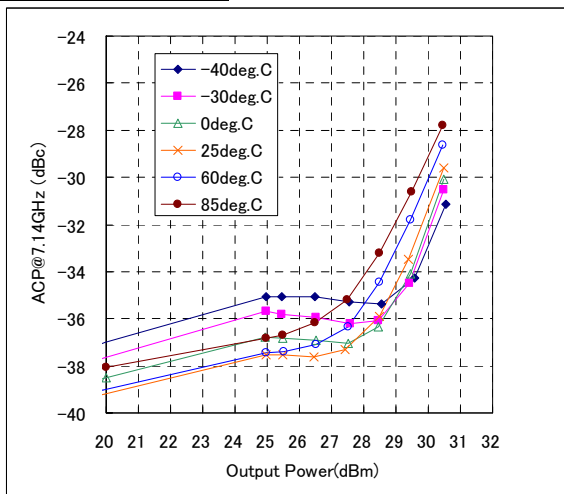

Specifications are subject to change without notice.

$V_c=5V$, $V_{ref}=2.8V$, $V_{cont}=0V$, Duty Cycle=50%, $f=3.4GHz$

Gain vs. Output Power

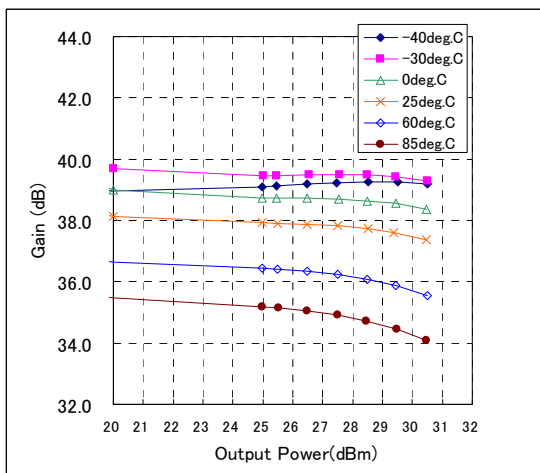

Operating Current vs. Output Power

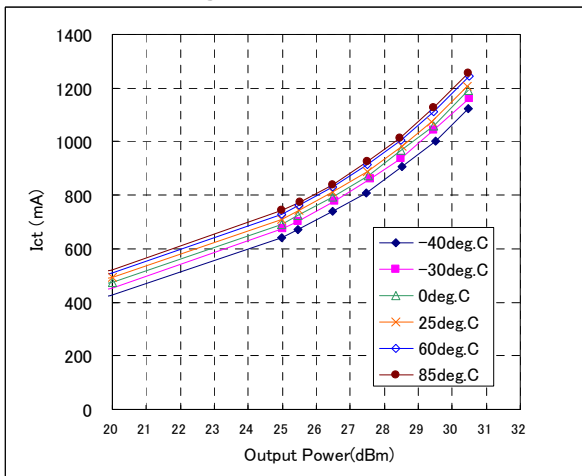

EVM vs. Output Power

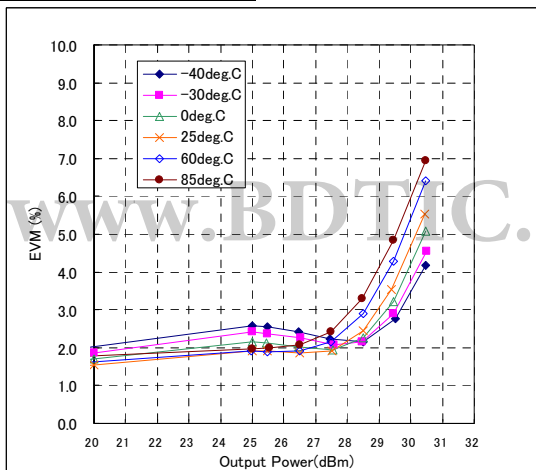

Detector Voltage vs. Output Power

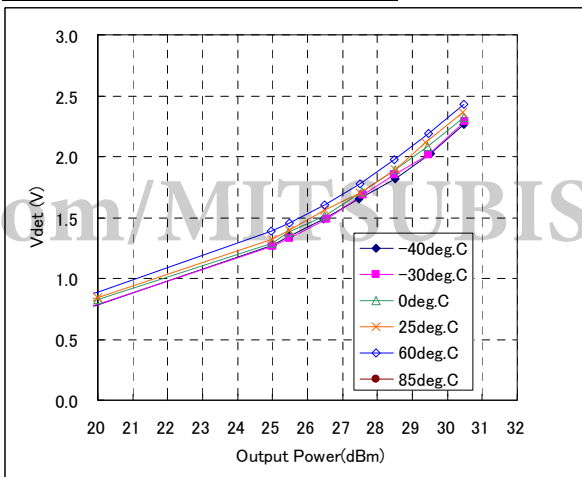

ACP Characteristics

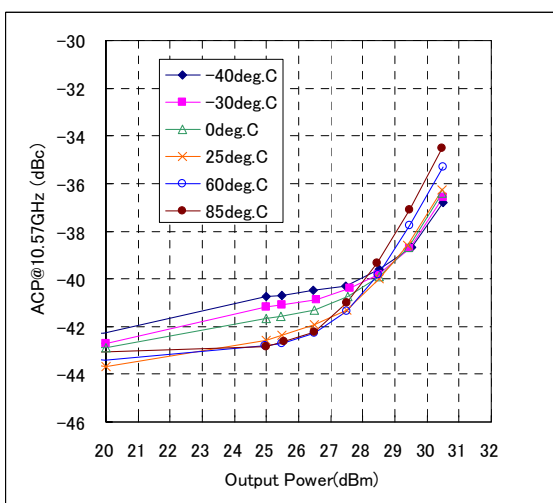
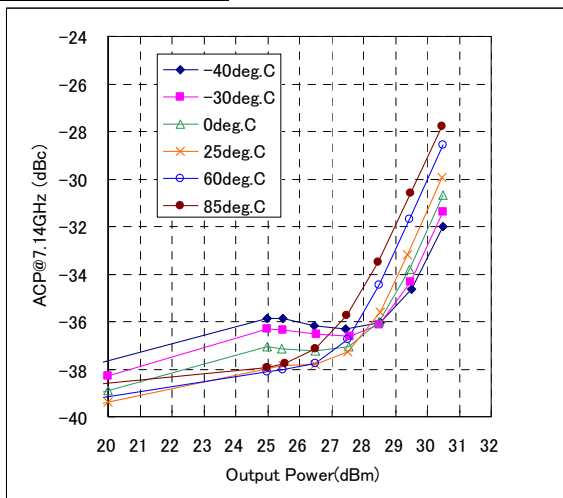

Specifications are subject to change without notice.

$V_c=5V$, $V_{ref}=2.8V$, $V_{cont}=0V$, Duty Cycle=50%, $f=3.5GHz$

Gain vs. Output Power

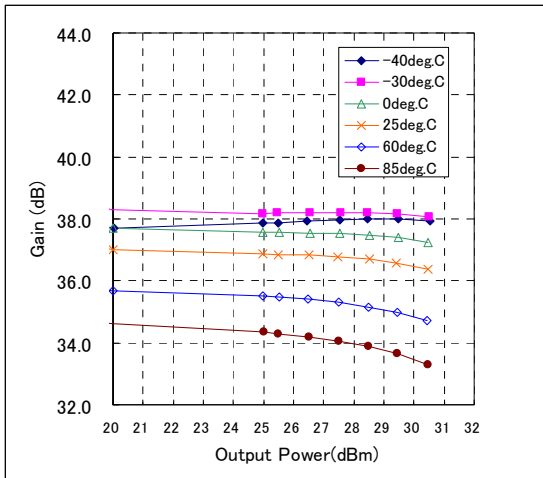

Operating Current vs. Output Power

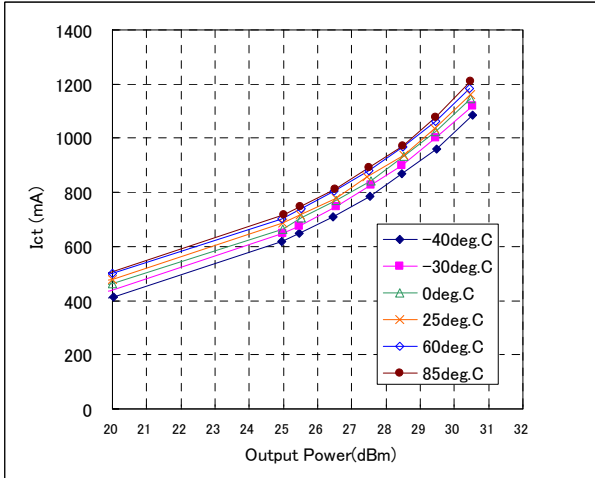

EVM vs. Output Power

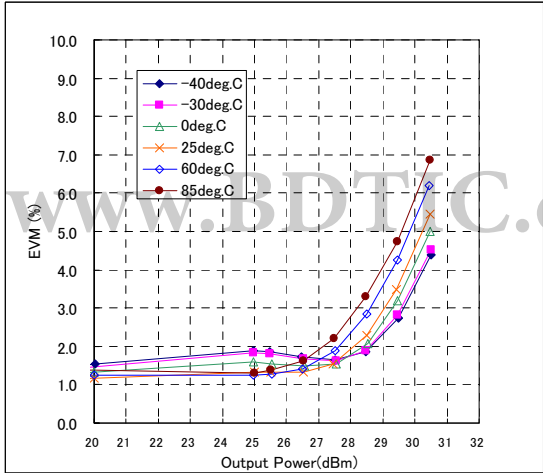

Detector Voltage vs. Output Power

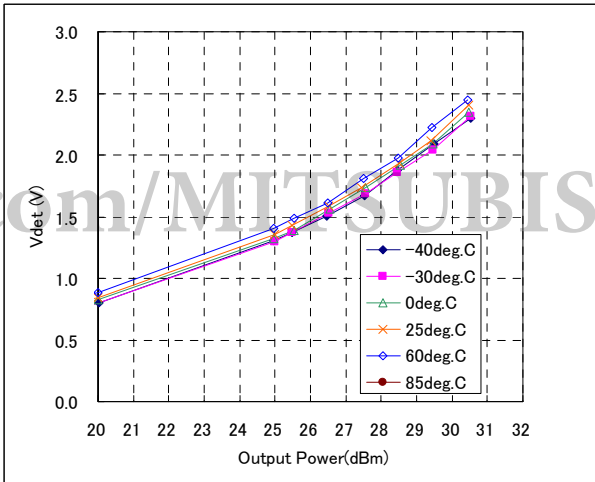

ACP Characteristics

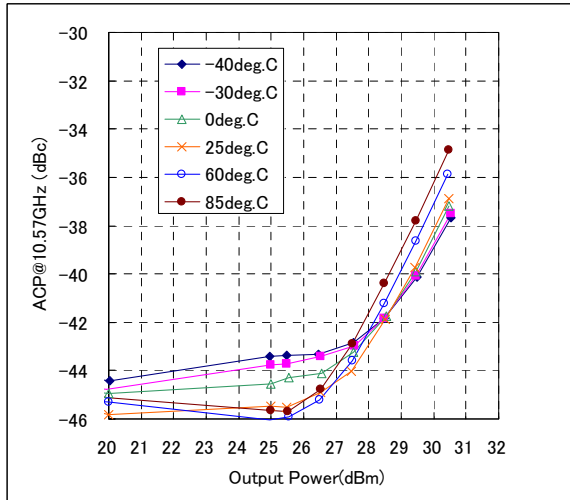
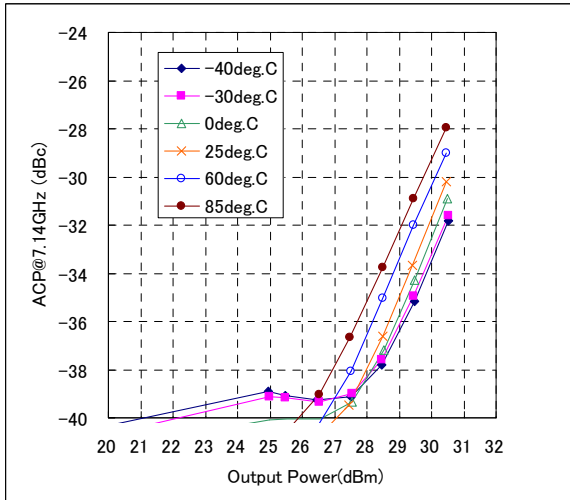

Specifications are subject to change without notice.

$V_c=5V$, $V_{ref}=2.8V$, $V_{cont}=0V$, Duty Cycle=50%, $f=3.6GHz$

Gain vs. Output Power

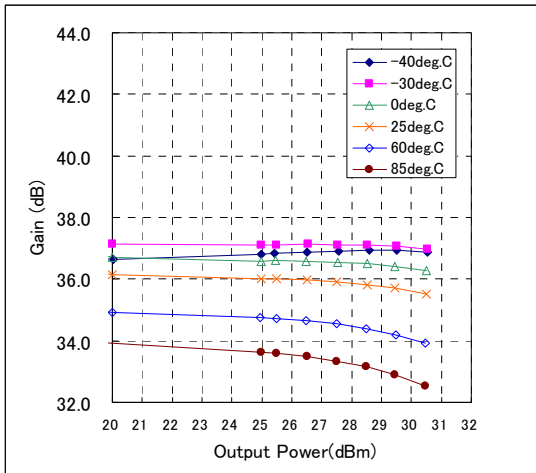

Operating Current vs. Output Power

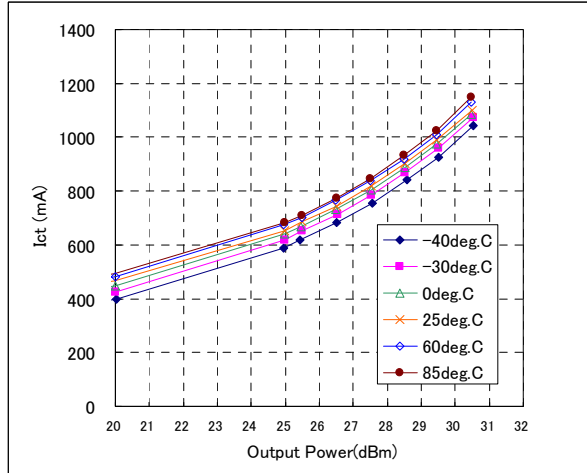

EVM vs. Output Power

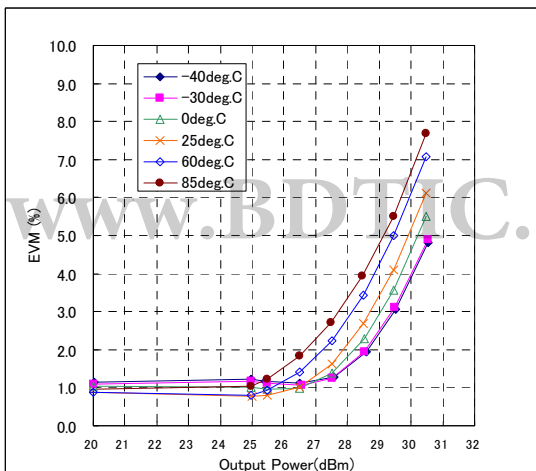

Detector Voltage vs. Output Power

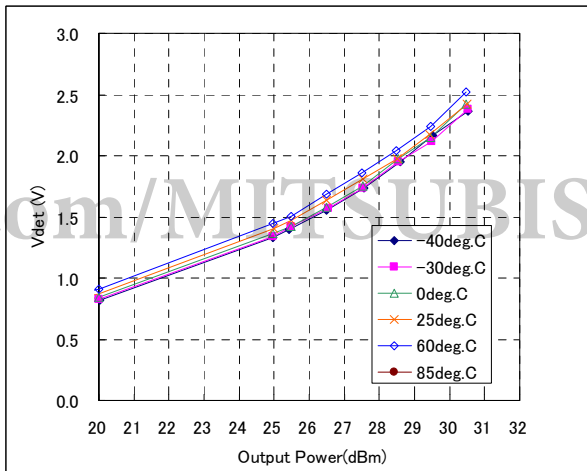

ACP Characteristics

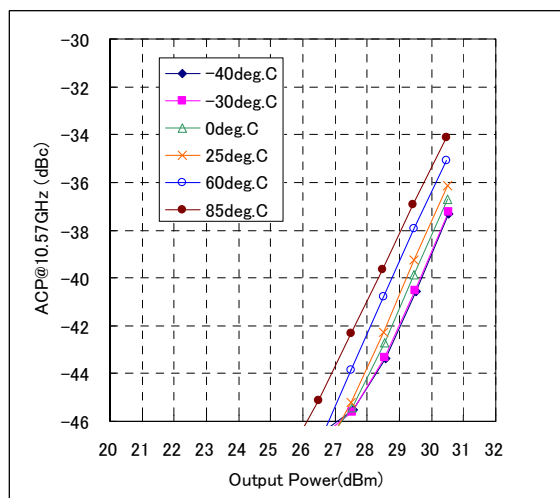
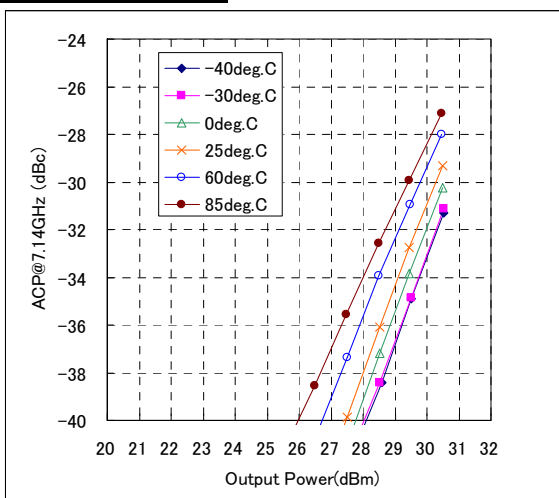

Specifications are subject to change without notice.

PERFORMANCE DATA (WiMAX OFDM 64QAM signal input)

$V_c=5V$, $V_{ref}=2.9V$, $V_{cont}=0V$, Duty Cycle=50%, $T_a=25deg.C$

Gain vs. Output Power

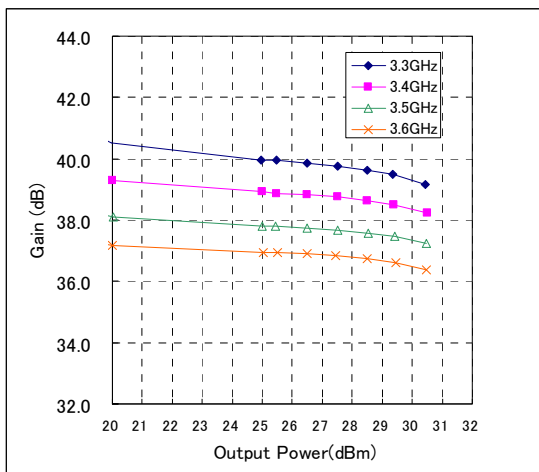

Operating Current vs. Output Power

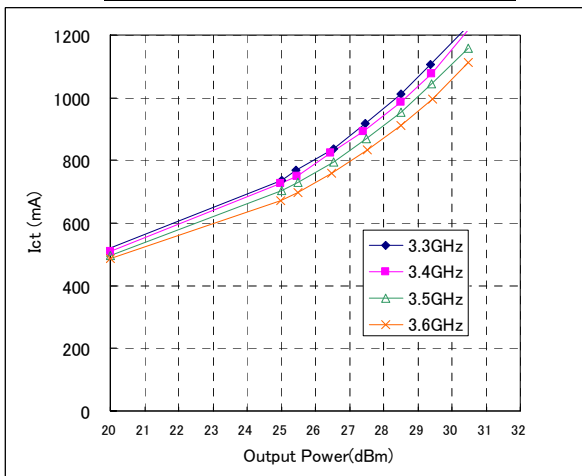

EVM vs. Output Power

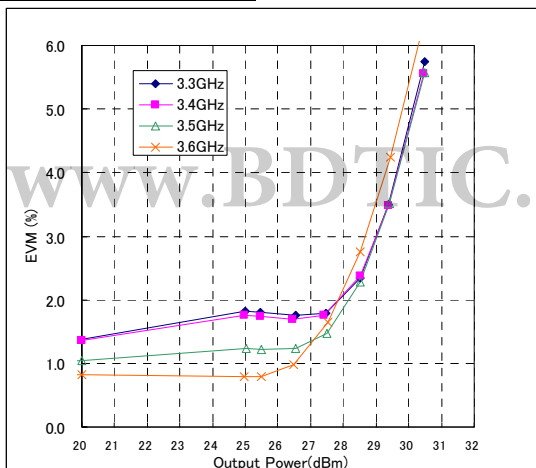

Detector Voltage vs. Output Power

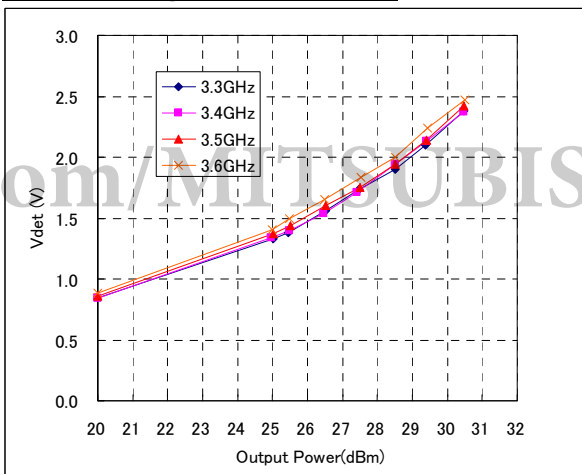

ACP Characteristics

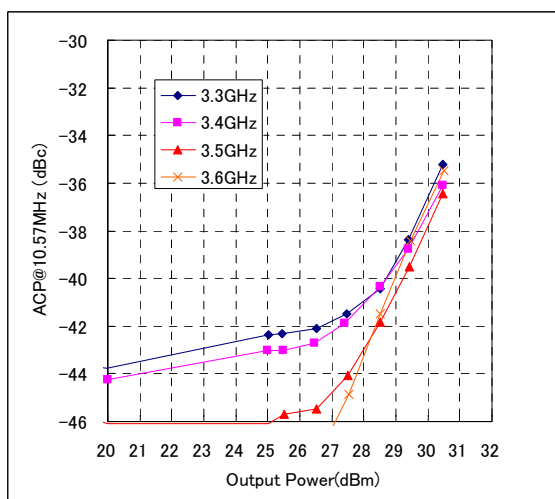
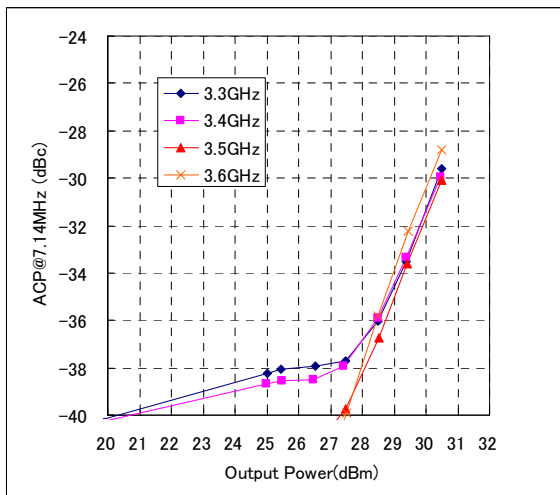

Specifications are subject to change without notice.

$V_c=5V$, $V_{ref}=2.9V$, $V_{cont}=0V$, Duty Cycle=50%, $f=3.3GHz$

Gain vs. Output Power

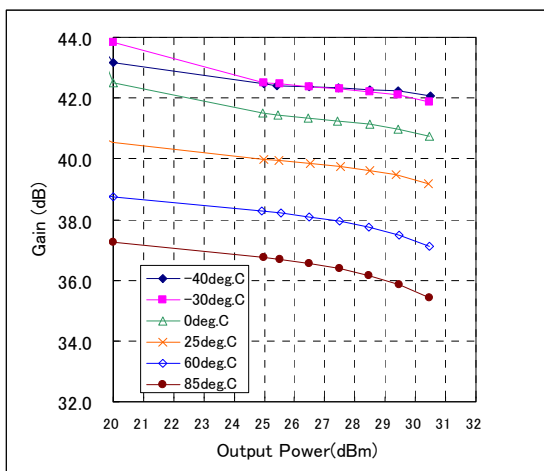

Operating Current vs. Output Power

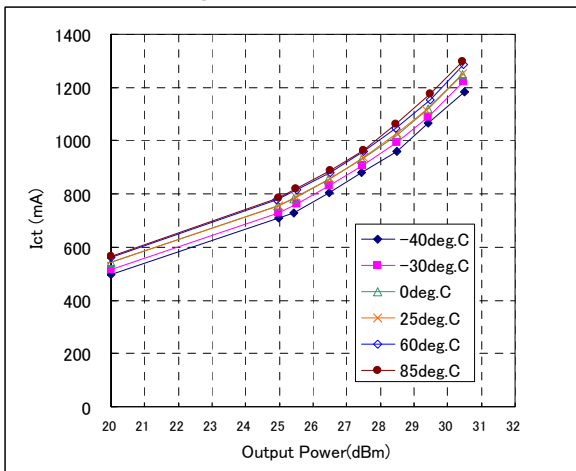

EVM vs. Output Power

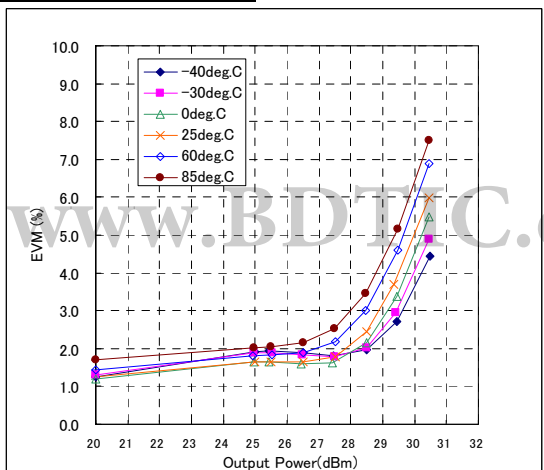

Detector Voltage vs. Output Power

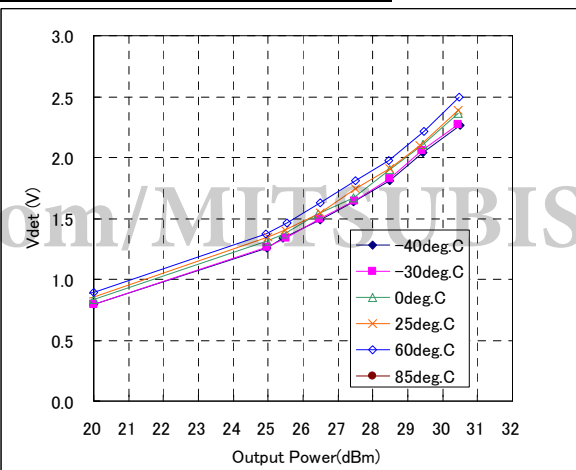

ACP Characteristics

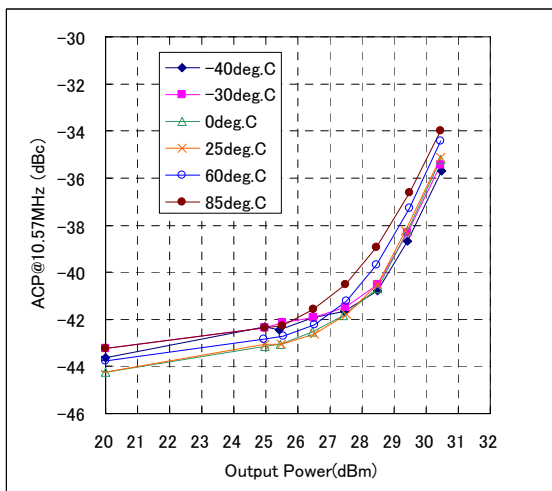
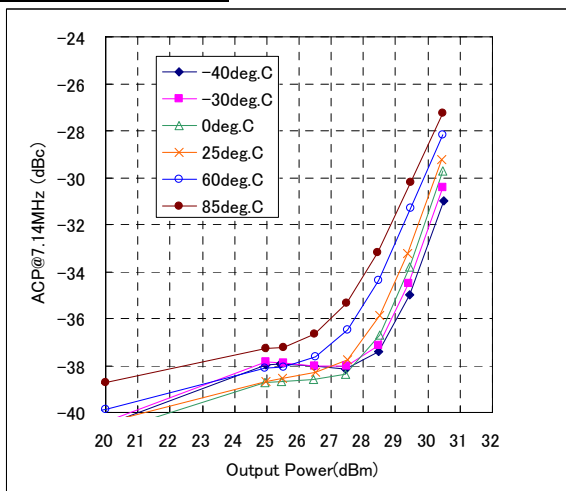

Specifications are subject to change without notice.

$V_c=5V$, $V_{ref}=2.9V$, $V_{cont}=0V$, Duty Cycle=50%, $f=3.4GHz$

Gain vs. Output Power

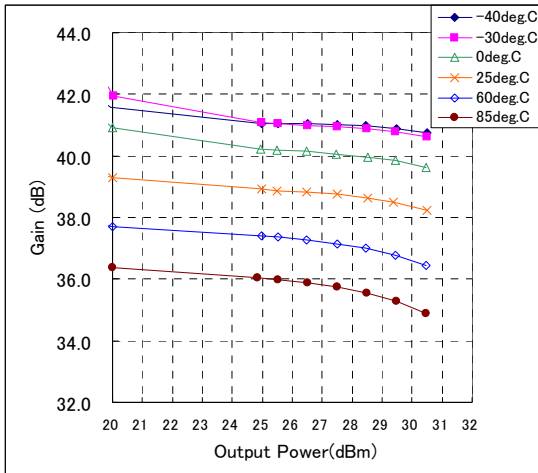

Operating Current vs. Output Power

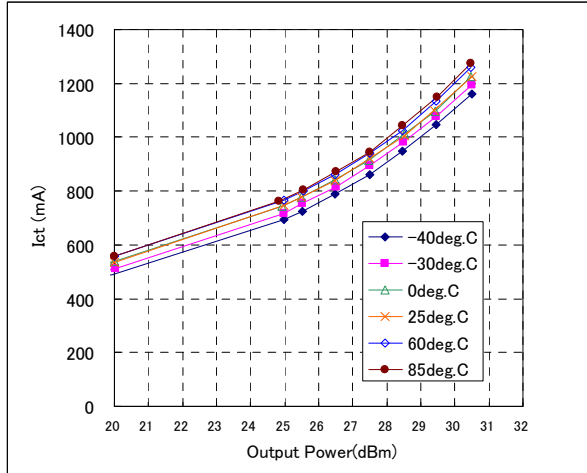

EVM vs. Output Power

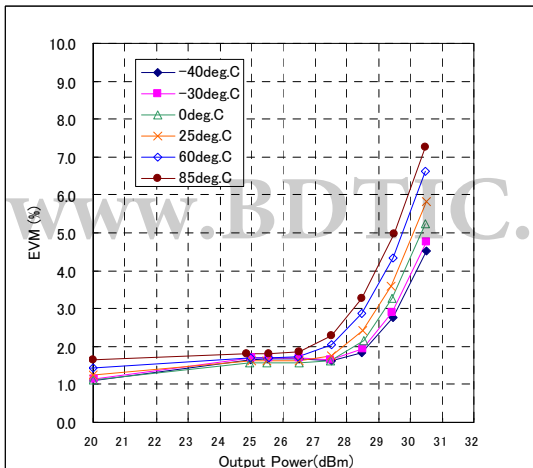

Detector Voltage vs. Output Power

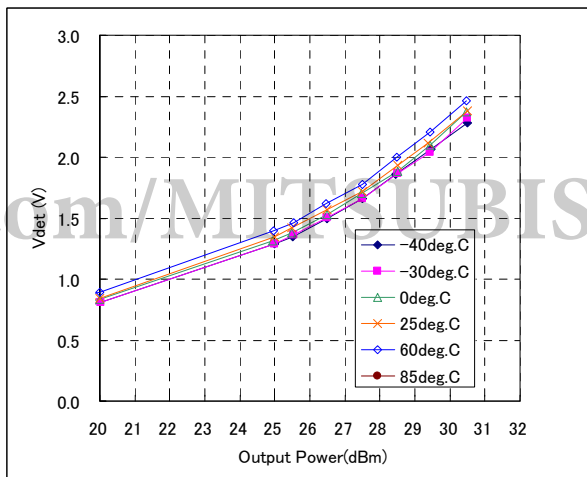

ACP Characteristics

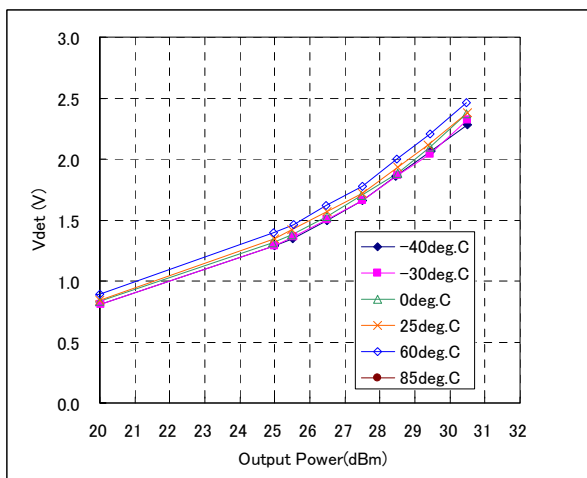
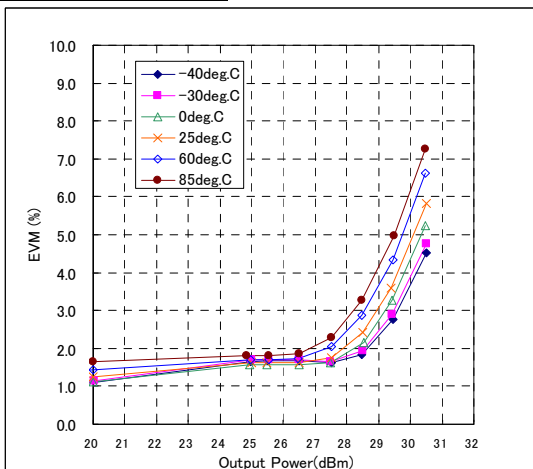

Specifications are subject to change without notice.

$V_c=5V$, $V_{ref}=2.9V$, $V_{cont}=0V$, Duty Cycle=50%, $f=3.5GHz$

Gain vs. Output Power

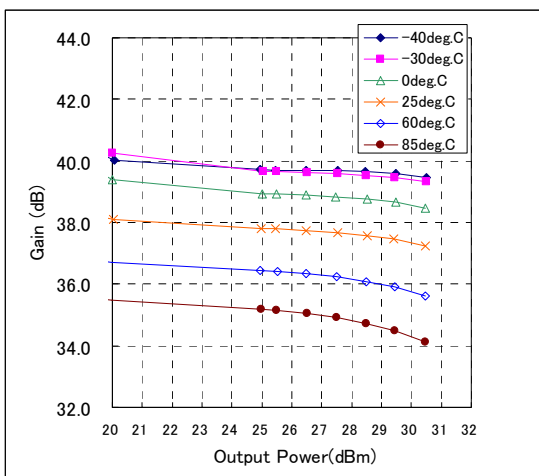

Operating Current vs. Output Power

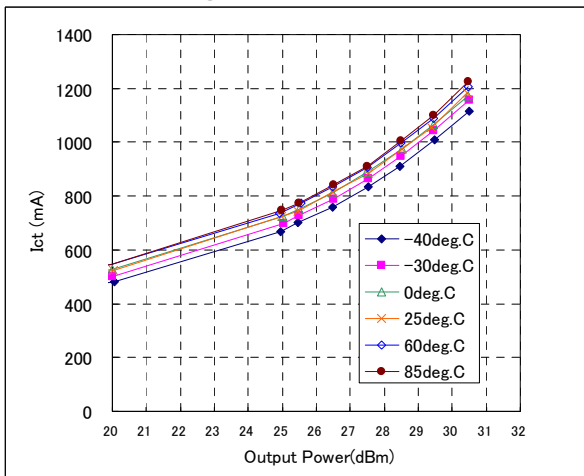

EVM vs. Output Power

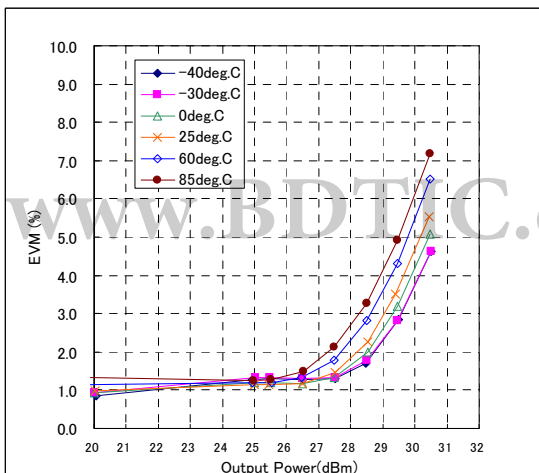

Detector Voltage vs. Output Power

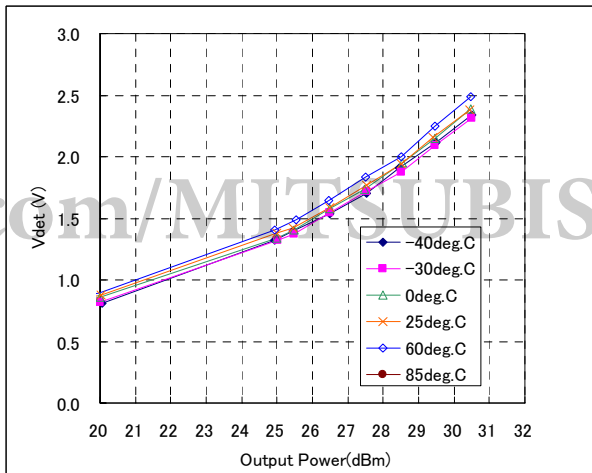

ACP Characteristics

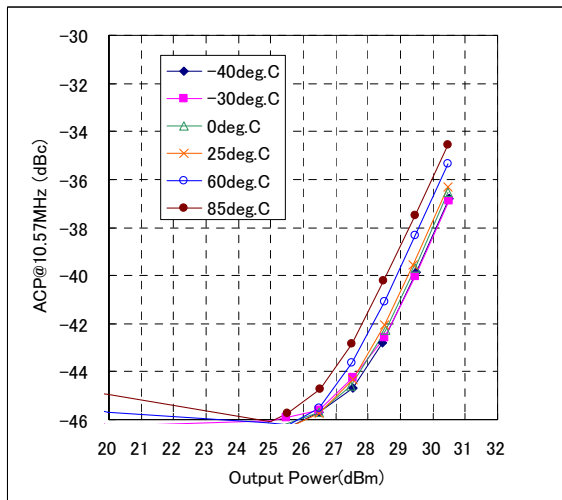
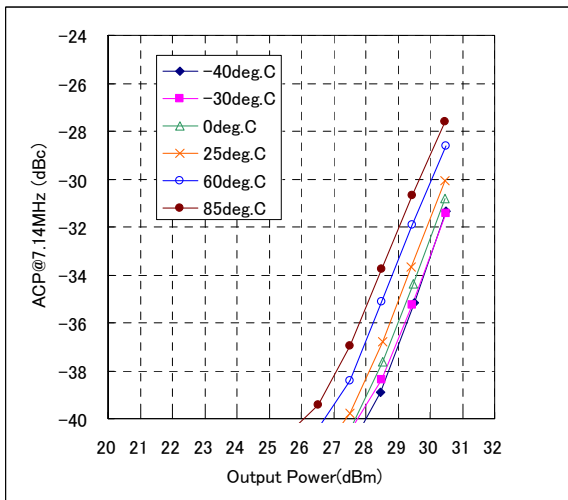

Specifications are subject to change without notice.

$V_c=5V$, $V_{ref}=2.9V$, $V_{cont}=0V$, Duty Cycle=50%, $f=3.6GHz$

Gain vs. Output Power

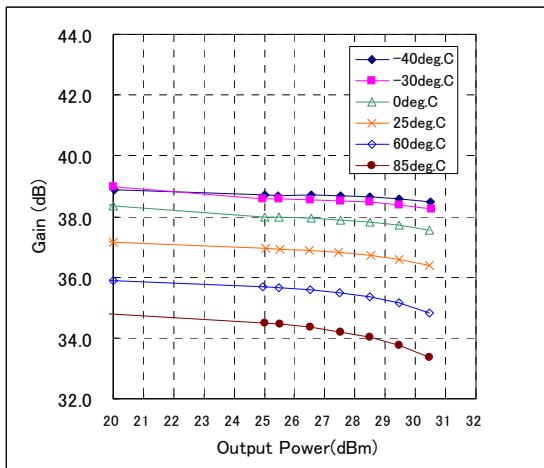

Operating Current vs. Output Power

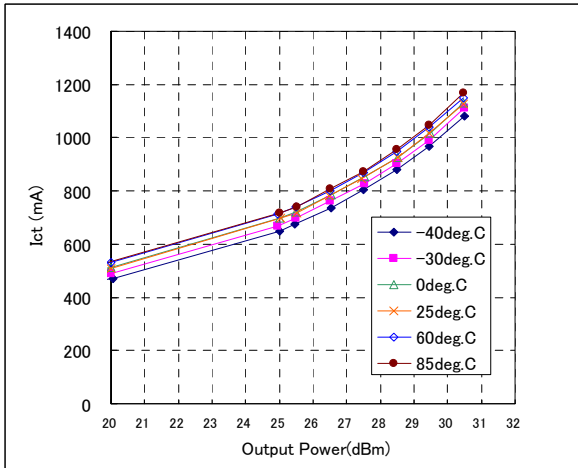

EVM vs. Output Power

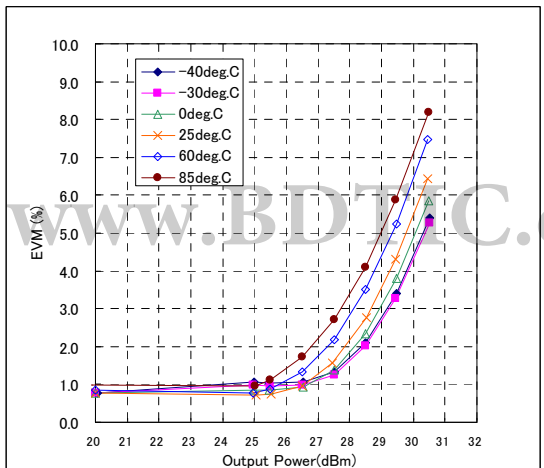

Detector Voltage vs. Output Power

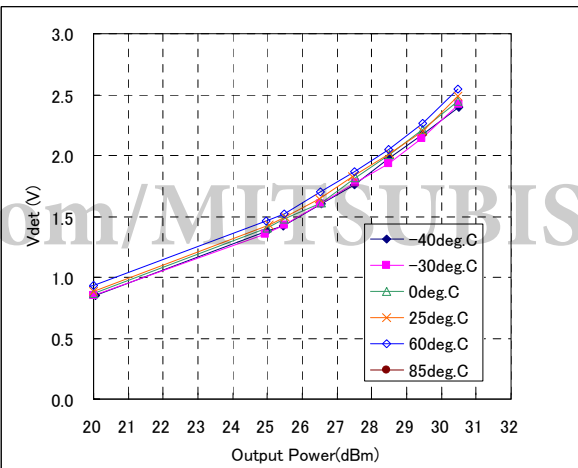

ACP Characteristics

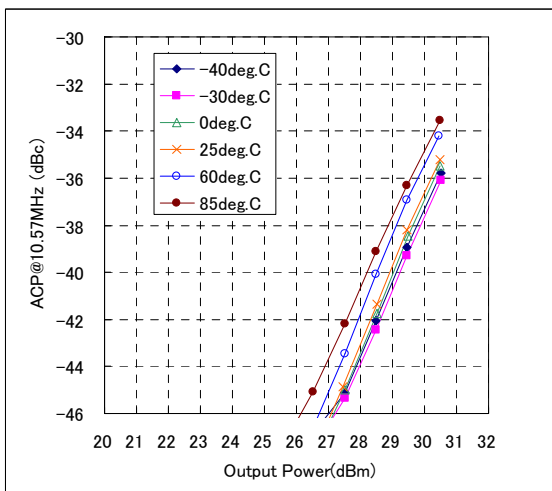
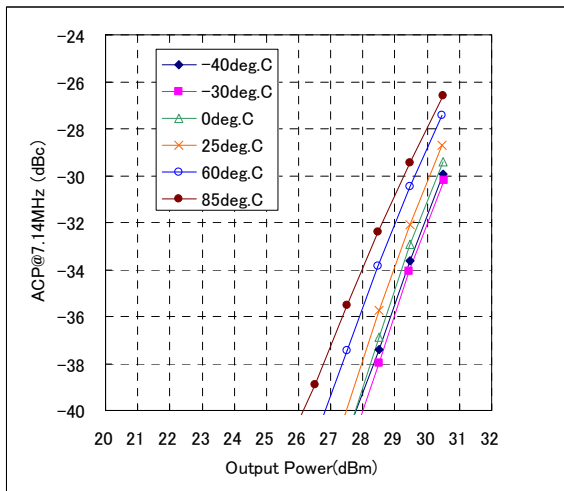

Specifications are subject to change without notice.

EXAMPLE LAYOUT OF EVALUATION BOARD

(40mm X 40mm, t=0.2mm(RF), Er=4.2, FR-4)

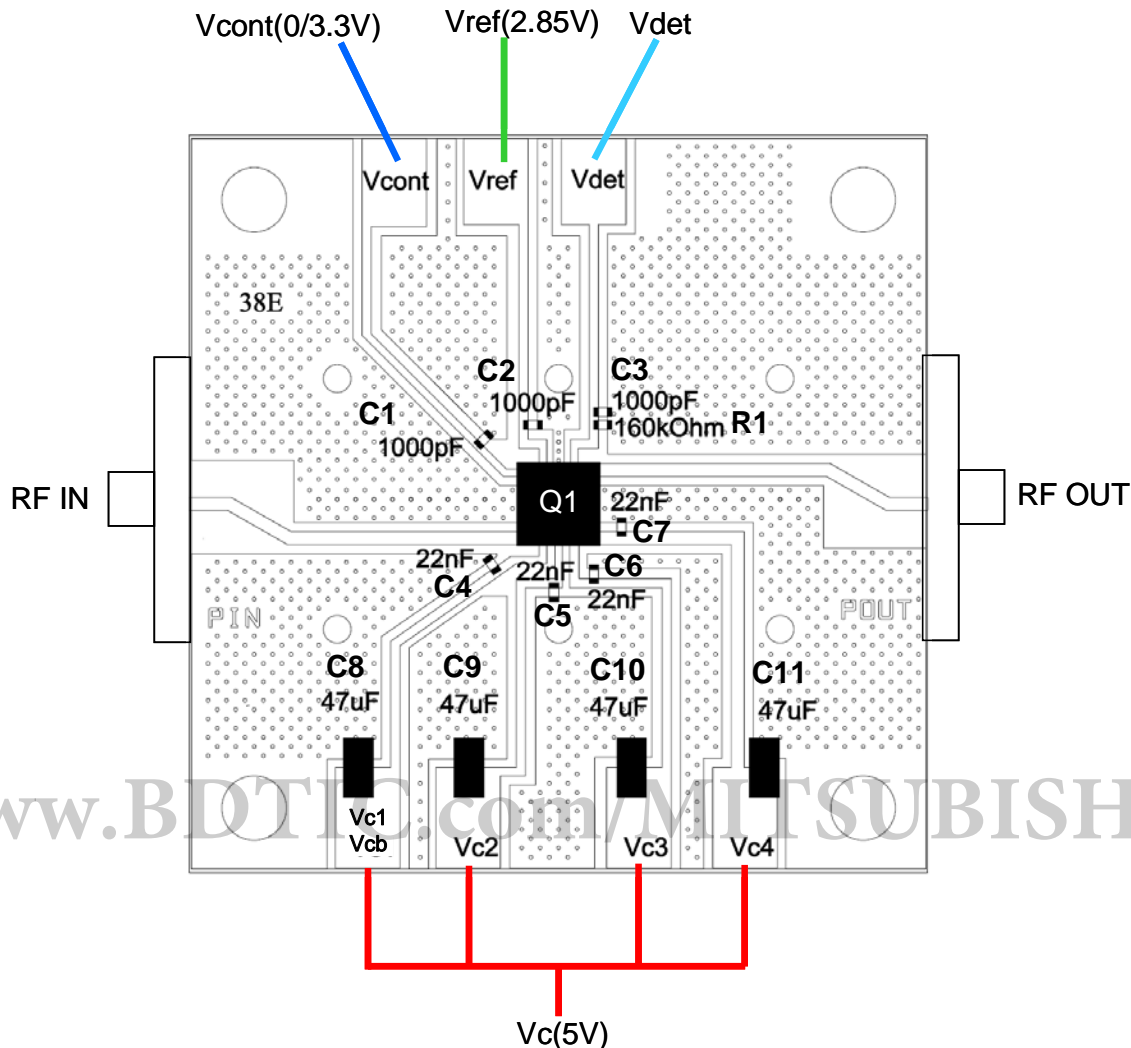

www.BDTC.com/MITSUBISHI

ITEM	DESCRIPTION	NOTE
Q1	MGFS38E3336	4mmX4mm
C1, C2, C3	1000pF, 1005	Murata, GRM155B11H102K
C4, C5, C6, C7	22 nF, 1005	Murata, GRM155B11C223K
C8, C9, C10, C11	47 uF, 3225	Murata, GRM32EB31C476K
R1	160K, 1005	Taiyosha, RPC03T164J

APPLICATION CIRCUIT EXAMPLE

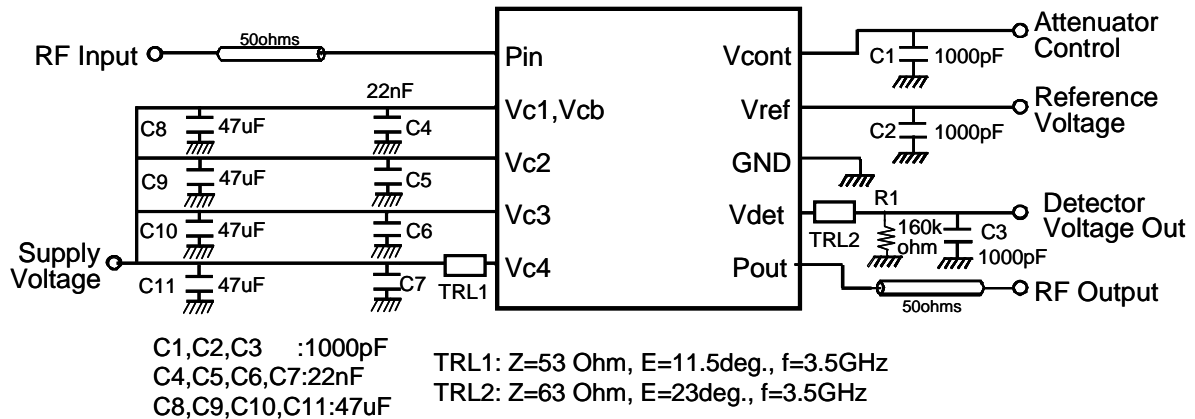

Put C1, C2, C4, C5, C6 as close as possible to device.
 Put C3 as close as possible to R1.

Pulse Operation is controlled by Vref

NOTE:

<Layout>

A properly designed PC board is essential to any RF/microwave circuit. Be sure to use controlled impedance lines on all high-frequency inputs and outputs. A ground plane should be present on both the top and bottom of the PC board and plated-through via holes connecting the top and bottom ground planes should be distributed. GND pins and ground paddle of the package should be connected to the bottom ground plane with plated-through via holes close to the package. To improve the heat resistance, place as many plated-through via holes as possible under the ground paddle (See page. 6).

<Bias circuit>

Each Vc node on the board should have its own decoupling capacitor to minimize supply coupling from one section of the MMIC to another. A bypass capacitor with low ESR at the RF frequency of operation is located close to the package to reject the RF noise.

Specifications are subject to change without notice.

PACKAGE OUTLINE

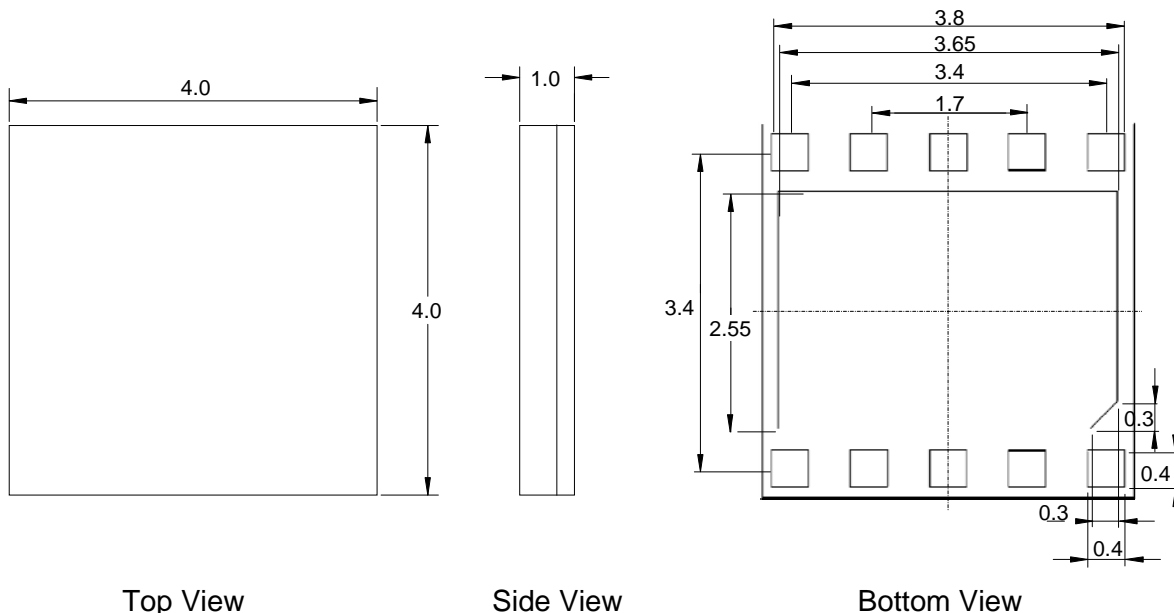

Top View

Side View

Bottom View

PACKAGE PIN ASSIGN

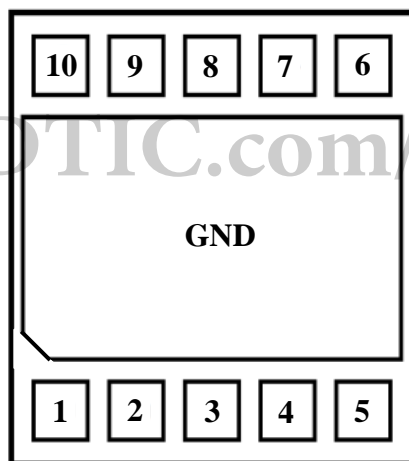

- 1 Pin**
- 2 Vc1, Vcb**
- 3 Vc2**
- 4 Vc3**
- 5 Vc4**
- 6 Pout**
- 7 Vdet**
- 8 GND**
- 9 Vref**
- 10 Vcont**

X-ray Top View

Mitsubishi Electric Corp. reserves the right to make changes to the product and its related material at any time without notice.

Pin	Function	Description
1	Pin	This is a RF input terminal.
2	Vc1,Vcb	This is a collector voltage of the 1st stage and the supply voltage for base bias circuits.(5V)
3	Vc2	This is a collector voltage of the 2nd stage. (5V)
4	Vc3	This is a collector voltage of the 3rd stage. (5V)
5	Vc4	This is a collector voltage of the 4th stage. (5V)
6	Pout	This is a RF output pin.
7	Vdet	This is an output port of the detector sampled at the output of the 3rd stage, and do not apply voltage. If you don't use the detector function, this pin should be connected to nothing.
8	GND	This pin is internally grounded inside the package and it is recommended to ground it.
9	Vref	This is a reference voltage and power up/down control pin. DC duty cycle is controlled with this pin.(2.85V/0V)
10	Vcont	This is a control voltage for attenuator. (0V/3.3V)

Specifications are subject to change without notice.

EXAMPLE METAL LAND PATTERN

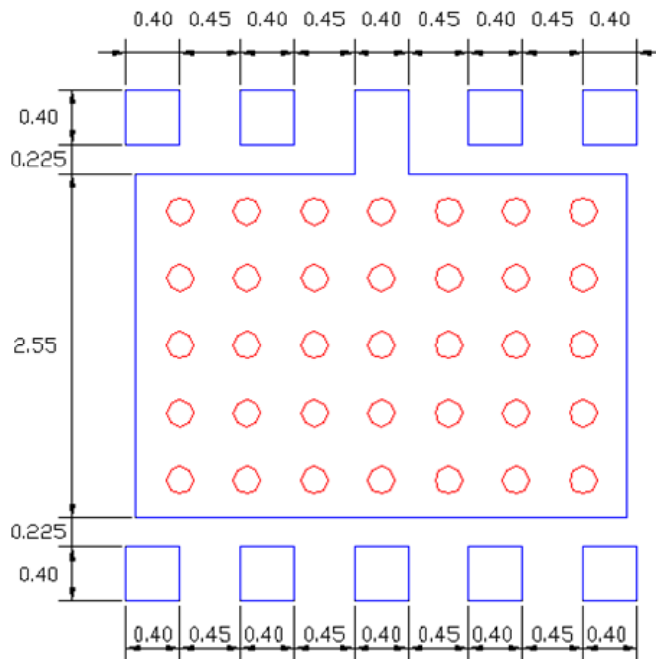

Note:

UNIT : mm

Through holes with 200um diameter should be put with a distance of 500um among them.

It is recommended that they have metallization of 25um thick on the inside wall.

www.BDTIC.com/MTSUBISHI

RECOMMENDED PULSE CONDITION

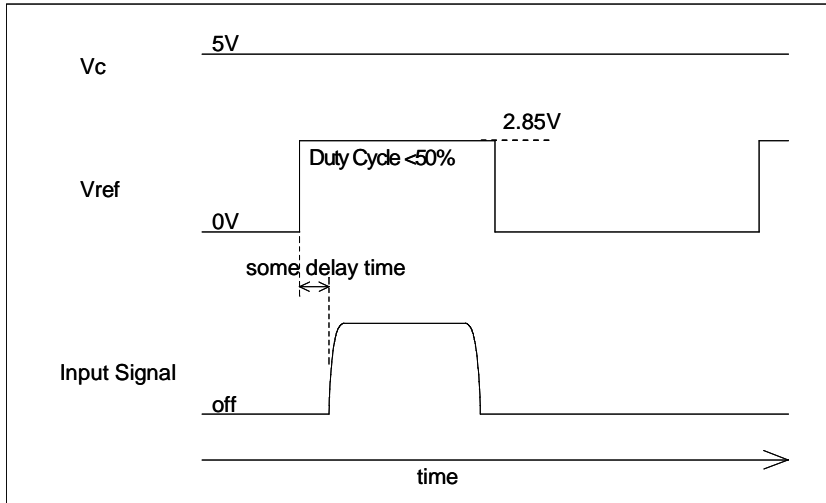

- This figure shows the timing chart between Vref and input signal.
- Only while the reference voltage is 2.85V, the device transmits the input signal (*1).
- Because the device needs appropriate set-up time before signal amplification, please note that there is some delay time (e.g. about the rise time of Vref) between the rise edge of Vref and that of the input signal.
- We recommend the device operate with less than 50% duty cycle of a 5msec period in order to ensure specified reliability.

*1: In case the device is operated under the Vref conditions of more than 50% duty cycle, self-heating will cause reliability problem, thereby degrading both power gain and EVM performance unexpectedly.

TEST SET-UP

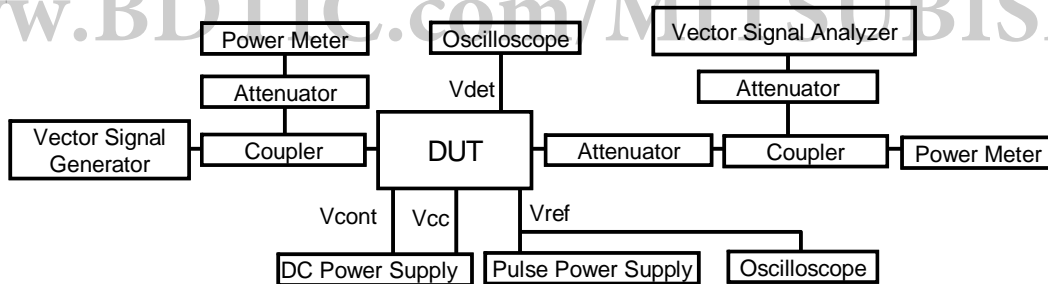

- Calibrate power meters at input/output ports on the EVB.
- Apply DC voltage to Vc (Vcb, Vc1~Vc4) and Vcont, where pulsed power supply should be applied to Vref for pulsed operation. .
- Monitor DC output voltage from Vdet using an oscilloscope or a multimeter.

<Power up sequence>

GND->Vc->Vref->Vcont

(1)Apply 5V to Vc, where stepping up from 0 to 5V is preferable.

(2)Supply pulsed voltage between 0 and 2.85V for Vref.

Please check the voltage level of Vref close to EVB and the timing chart between Vref and input signal using an oscilloscope. Also please do not apply supply voltage exceeding 3V(absolute maximum rating) to the Vref terminal.

(3)Supply Vcont with 3.3V for the attenuation mode. In the thru-mode, apply 0V to Vcont or keep it open.

<Power off sequence>

Vcont->Vref->Vc->GND

The reverse procedure is recommended for bias off.

Specifications are subject to change without notice.

HANDLING PRECAUTION

- 1) Work desk, test equipment, soldering iron and worker should be grounded before mounting and testing. Please note that electric discharge of GaAs (InGaP) HBT is much more sensitive than that of Si transistor. Handling without ground possibly damages GaAs HBT.
- 2) The surface of a board on which this product is mounted should be as flat and clean as possible to prevent a substrate from cracking by bending this product.
- 3) IR reflow soldering condition is confirmed following profile (Max. two times). The PA surface temperatures are shown in the profile.

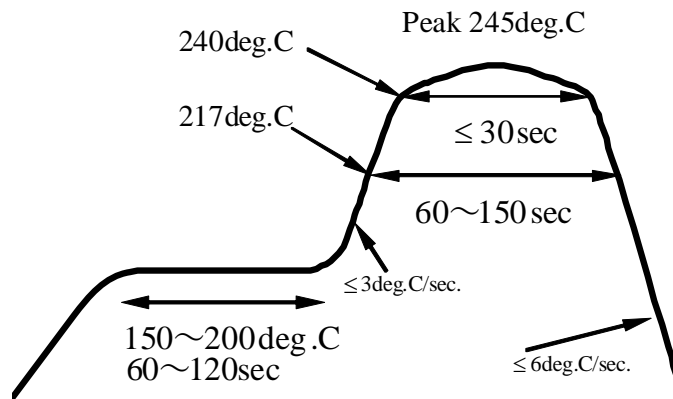

- 4) Handling precaution at high temperature
 In case of heating this product, please keep the same heat profile as recommended reflow one. Please note that crack, flaw or modification may be generated if softened epoxy resin part is handled with tweezers and etc at high temperature.
- 5) Cleaning condition
 Please select after confirming administrative guidance, legal restrictions, and the mass of the residual ion contaminant etc., and use it.
- 6) After soldering, please remove the flux. Please take care that solvent does not penetrate into this product.
- 7) GaAs HBT contains As (Arsenic). This product should be dumped as particular industrial waste.

www.BDTIC.com/MITSUBISHI