

MITSUBISHI SEMICONDUCTOR &lt;Intelligent Power Module&gt;

# MIG150J6CSB1W (600V/150A 6in1)

High Power Switching Applications

Motor Control Applications

- Integrates inverter and control circuits (IGBT drive units, and units for protection against short-circuit current, overcurrent, undervoltage and overtemperature) into a single package.
- The electrodes are isolated from case.
- Low thermal resistance
- $V_{CE(sat)} = 1.9\text{ V (typ.)}$
- UL recognized: File No. E87989

## Equivalent Circuit

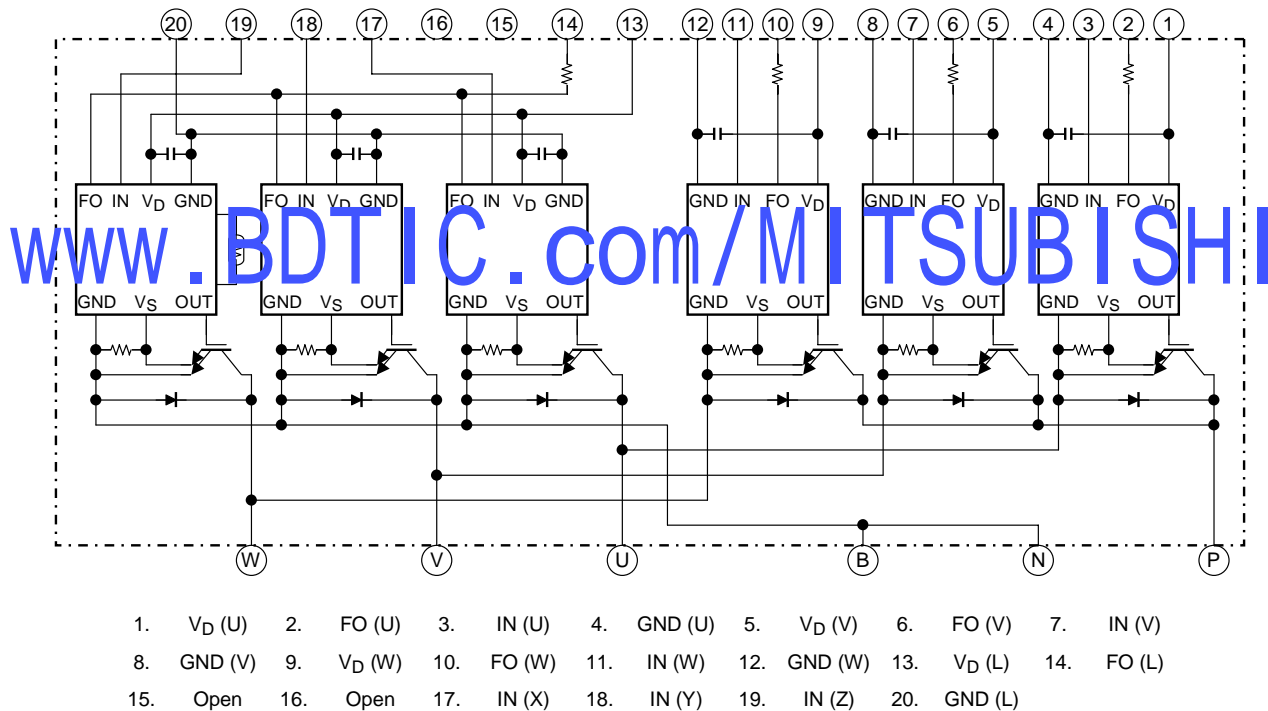

## Package Dimensions

Unit : mm

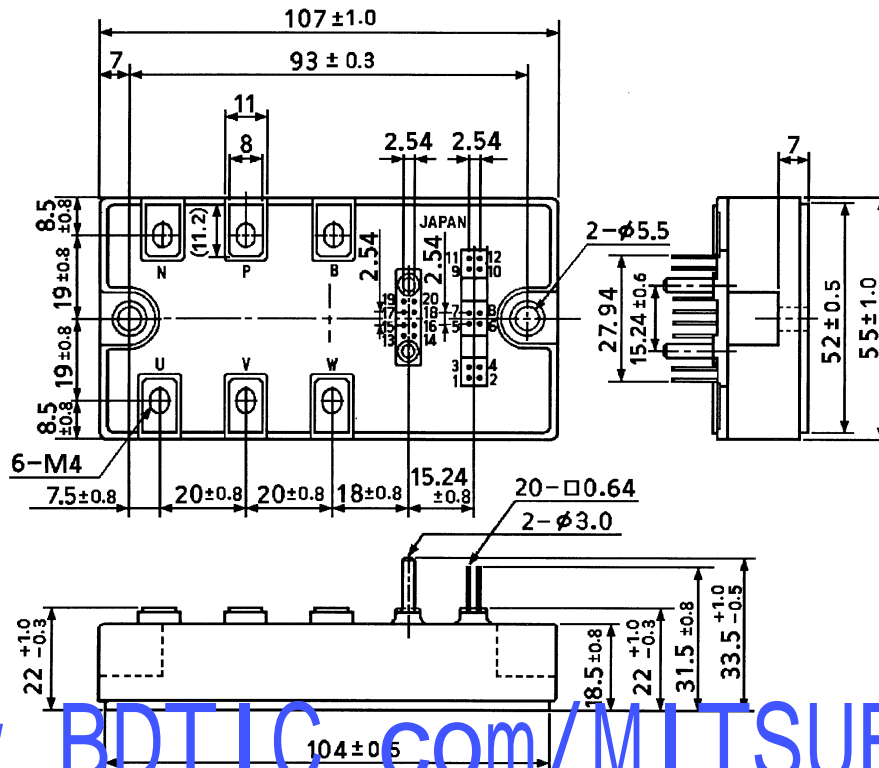

[www.BDTIC.com/MITSUBISHI](http://www.BDTIC.com/MITSUBISHI)

- |     |                    |     |         |     |                    |     |         |     |                    |     |         |
|-----|--------------------|-----|---------|-----|--------------------|-----|---------|-----|--------------------|-----|---------|
| 1.  | V <sub>D</sub> (U) | 2.  | FO (U)  | 3.  | IN (U)             | 4.  | GND (U) | 5.  | V <sub>D</sub> (V) | 6.  | FO (V)  |
| 7.  | IN (V)             | 8.  | GND (V) | 9.  | V <sub>D</sub> (W) | 10. | FO (W)  | 11. | IN (W)             | 12. | GND (W) |
| 13. | V <sub>D</sub> (L) | 14. | FO (L)  | 15. | Open               | 16. | Open    | 17. | IN (X)             | 18. | IN (Y)  |
| 19. | IN (Z)             | 20. | GND (L) |     |                    |     |         |     |                    |     |         |

Signal Terminal Layout

Unit : mm

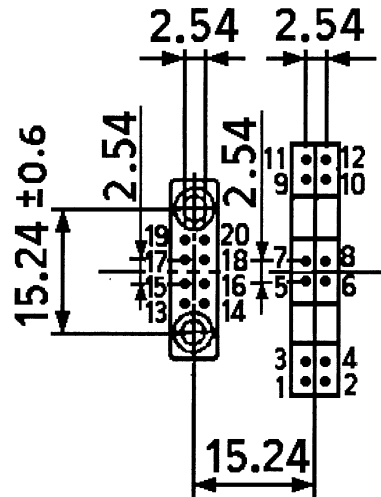

www.BDTIC.com/MITSUBISHI

1. V <sub>D</sub> (U)	2. FO (U)	3. IN (U)	4. GND (U)	5. V <sub>D</sub> (V)	6. FO (V)
7. IN (V)	8. GND (V)	9. V <sub>D</sub> (W)	10. FO (W)	11. IN (W)	12. GND (W)
13. V <sub>D</sub> (L)	14. FO (L)	15. Open	16. Open	17. IN (X)	18. IN (Y)
19. IN (Z)	20. GND (L)				

Maximum Ratings ( $T_j = 25^\circ\text{C}$ )

Stage	Characteristics	Condition	Symbol	Rated	Unit
Inverter	Supply voltage	P-N power terminal	$V_{CC}$	450	V
	Collector-emitter voltage	—	$V_{CES}$	600	V
	Collector current	$T_c = 25^\circ\text{C}$ , DC	$I_C$	150	A
	Forward current	$T_c = 25^\circ\text{C}$ , DC	$I_F$	150	A
	Collector power dissipation	$T_c = 25^\circ\text{C}$ , DC	$P_C$	740	W
	Junction temperature	—	$T_j$	150	$^\circ\text{C}$
Control	Control supply voltage	$V_D$ -GND Terminal	$V_D$	20	V
	Input voltage	IN-GND Terminal	$V_{IN}$	20	V
	Fault output voltage	FO-GND Terminal	$V_{FO}$	20	V
	Fault output current	FO sink current	$I_{FO}$	14	mA
Module	Operating temperature	—	$T_c$	-20 to +100	$^\circ\text{C}$
	Storage temperature range	—	$T_{stg}$	-40 to +125	$^\circ\text{C}$
	Isolation voltage	AC 1 min	$V_{ISO}$	2500	V
	Screw torque (terminal)	M4	—	2	N·m
	Screw torque (mounting)	M5	—	3	N·m

## Electrical Characteristics

## 1. Inverter Stage

Characteristics	Symbol	Test Condition	Min	Typ	Max	Unit
Collector cut-off current	$I_{CEX}$	$V_{CE} = 600\text{ V}$ $T_j = 25^\circ\text{C}$	—	—	1	mA
Collector-emitter saturation voltage	$V_{CE(sat)}$	$V_D = 15\text{ V}$ $I_C = 150\text{ A}$ $V_{IN} = 15\text{ V} \rightarrow 0\text{ V}$ $T_j = 25^\circ\text{C}$	1.6	1.9	2.3	V
		$T_j = 125^\circ\text{C}$	—	2.1	—	
Forward voltage	$V_F$	$I_F = 150\text{ A}$ , $T_j = 25^\circ\text{C}$	—	2.4	2.8	V
Switching time	$t_{on}$	$V_{CC} = 300\text{ V}$ , $I_C = 150\text{ A}$ $V_D = 15\text{ V}$ , $V_{IN} = 15\text{ V} \leftrightarrow 0\text{ V}$ $T_j = 25^\circ\text{C}$ , Inductive load (Note 1)	—	1.3	2.2	$\mu\text{s}$
	$t_c(on)$		—	0.3	—	
	$t_{rr}$		—	0.2	—	
	$t_{off}$		—	1.1	2.1	
	$t_c(off)$		—	0.2	—	

Note 1: Switching time test circuit and timing chart

**2. Control Stage ( $T_j = 25^\circ\text{C}$ )**

Characteristics		Symbol	Test Condition	Min	Typ.	Max	Unit
Control circuit current	High side	$I_D$ (H)	$V_D = 15\text{ V}$	—	13	17	mA
	Low side	$I_D$ (L)		—	39	51	
Input on signal voltage		$V_{IN}$ (on)	$V_D = 15\text{ V}$	1.4	1.6	1.8	V
Input off signal voltage		$V_{IN}$ (off)		2.2	2.5	2.8	V
Fault output current	Protection	$I_{FO}$ (on)	$V_D = 15\text{ V}$	—	10	12	mA
	Normal	$I_{FO}$ (off)		—	—	0.1	
Over current protection trip level	Inverter	OC	$V_D = 15\text{ V}, T_j \leq 125^\circ\text{C}$	240	—	—	A
Short circuit protection trip level	Inverter	SC	$V_D = 15\text{ V}, T_j \leq 125^\circ\text{C}$	240	—	—	A
Over current cut-off time		$t_{off}$ (OC)	$V_D = 15\text{ V}$	—	5	—	$\mu\text{s}$
Over temperature protection	Trip level	OT	Case temperature	110	118	125	$^\circ\text{C}$
	Reset level	OTr		—	98	—	
Control supply under voltage protection	Trip level	UV	—	11.0	12.0	12.5	V
	Reset level	UVr		12.0	12.5	13.0	
Fault output pulse width		$t_{FO}$	$V_D = 15\text{ V}$	1	2	3	ms

**3. Thermal Resistance ( $T_c = 25^\circ\text{C}$ )**

Characteristics		Symbol	Test Condition	Min	Typ.	Max	Unit
Junction to case thermal resistance	Inverter IGBT	$R_{th}$ (j-c)	Inverter IGBT	—	—	0.167	$^\circ\text{C/W}$
			Inverter FRD	—	—	0.310	
Case to fin thermal resistance		$R_{th}$ (c-f)	Compound is applied	—	0.17	—	$^\circ\text{C/W}$

www.BDTIC.com/MITSUBISHI

Switching Time Test Circuit

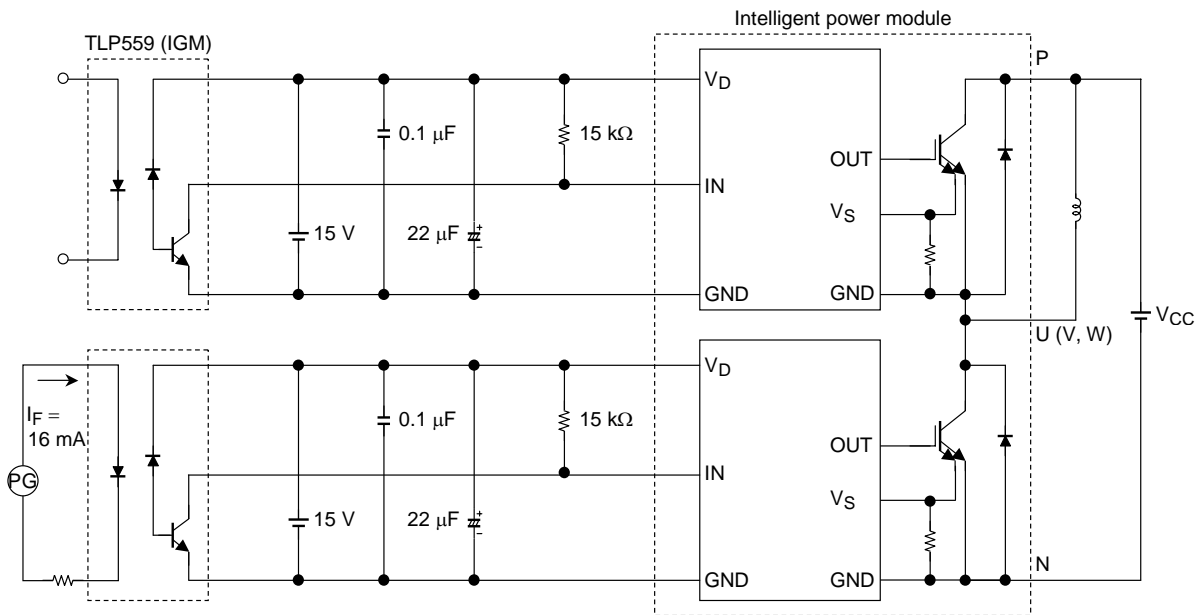

Timing Chart

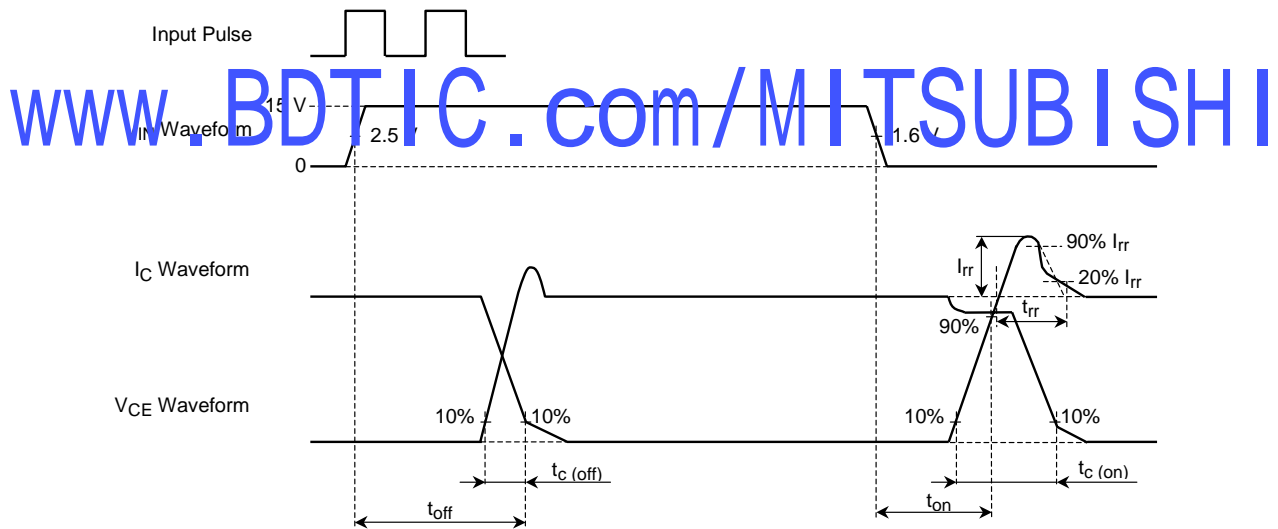

[www.BDTIC.com/MITSUBISHI](http://www.BDTIC.com/MITSUBISHI)

#### 4. Recommended conditions for application

Characteristics	Symbol	Test Condition	Min	Typ.	Max	Unit
Supply voltage	$V_{CC}$	P-N Power terminal	—	300	400	V
Control supply voltage	$V_D$	$V_D$ -GND Signal terminal	13.5	15	16.5	V
Carrier frequency	$f_c$	PWM Control	—	—	20	kHz
Dead time	$t_{dead}$	Switching time test circuit (see page.6) (Note 2)	3	—	—	$\mu$ s

Note 2: The table lists Dead time requirements for the module input, excluding photocoupler delays. When specifying dead time requirements for the photocoupler input, please add photocoupler delays to the dead time given above.

#### Dead Time Timing Chart

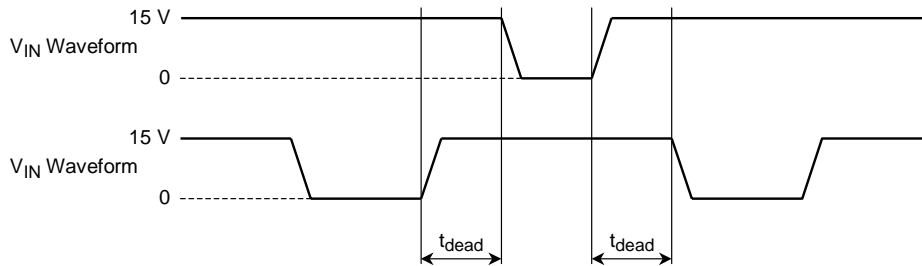

[www.BDTIC.com/MITSUBISHI](http://www.BDTIC.com/MITSUBISHI)

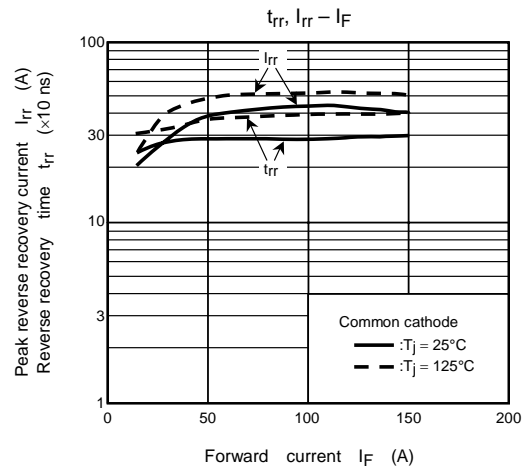
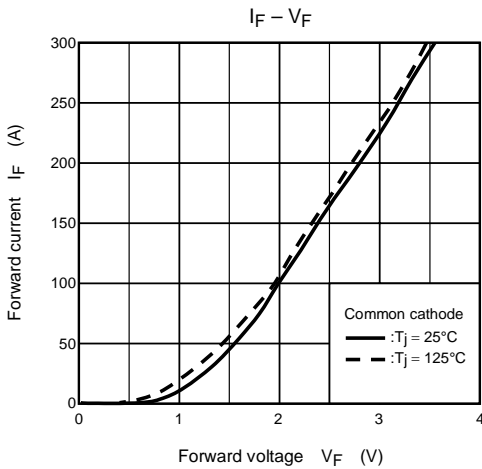
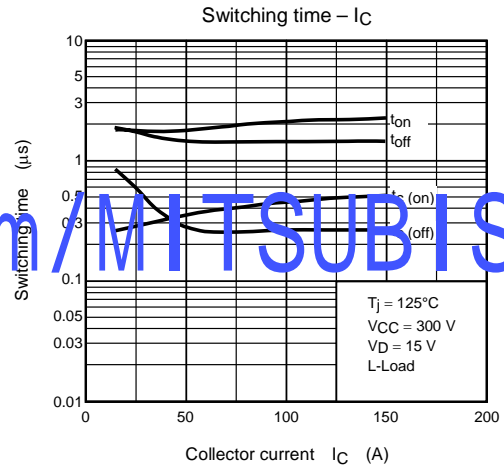
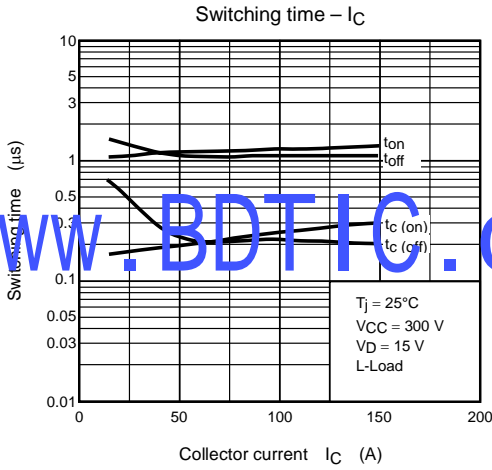
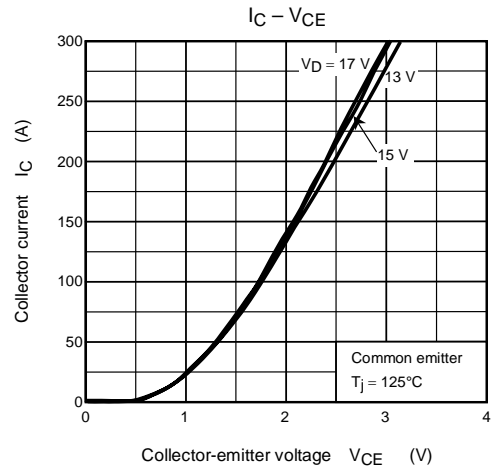
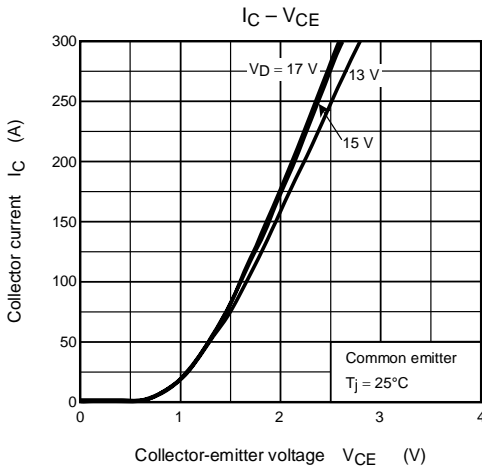

www.BDTIC.com / MITSUBISHI



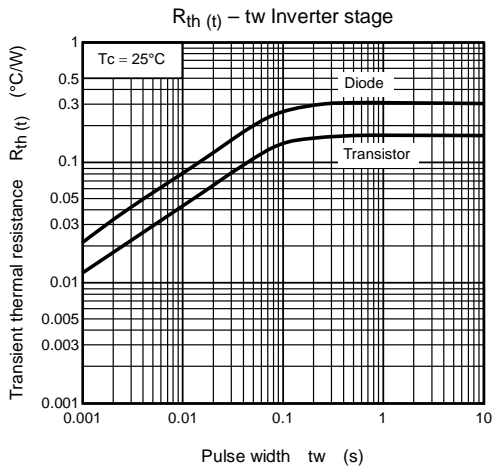
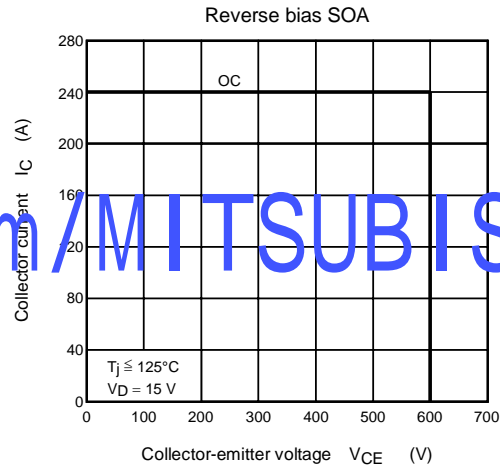
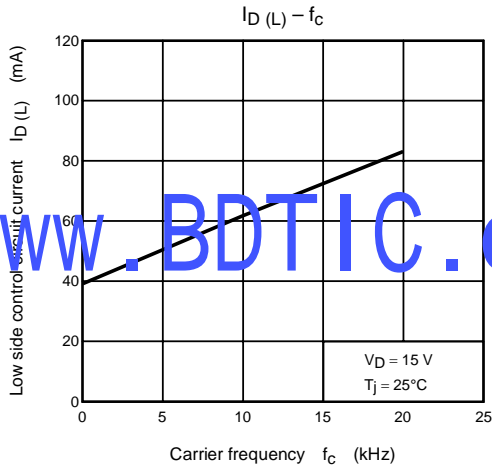
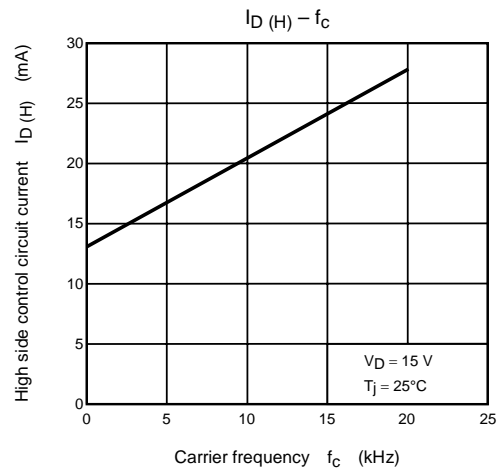
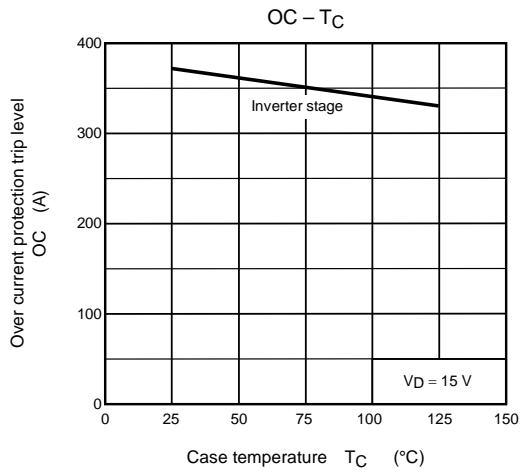

www.BDTIC.com/MITSUBISHI

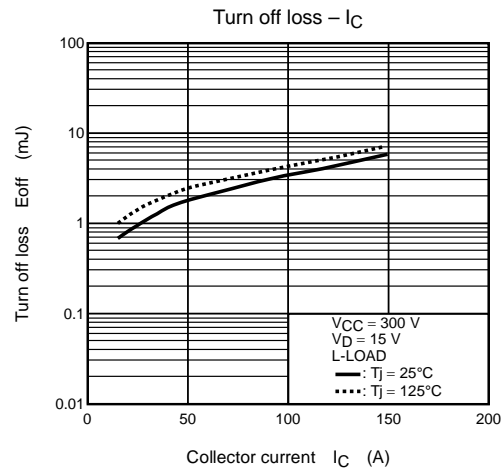
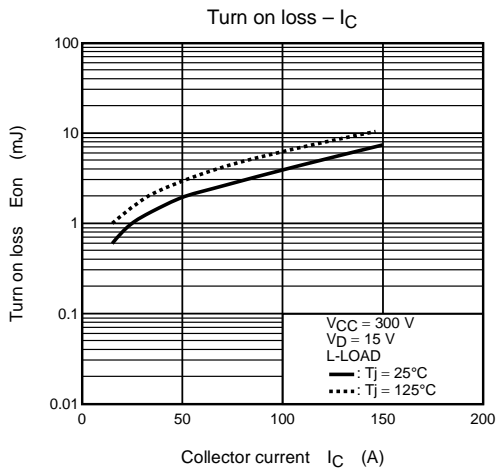

[www.BDTIC.com/MITSUBISHI](http://www.BDTIC.com/MITSUBISHI)