

MITSUBISHI SEMICONDUCTOR <Intelligent Power Module>

MIG300Q2CMB1X (1200V/300A 2in1)

High Power Switching Applications

Motor Control Applications

- Integrates inverter power circuits and control circuits (IGBT drive unit, units for protection against short-circuit current, overcurrent, undervoltage and overtemperature) into a single package.
- The electrodes are isolated from the case.
- Low thermal resistance
- $V_{CE(sat)} = 2.4 \text{ V (typ.)}$
- UL recognized: File No.E87989
- Weight: 380 g (typ.)

Equivalent Circuit

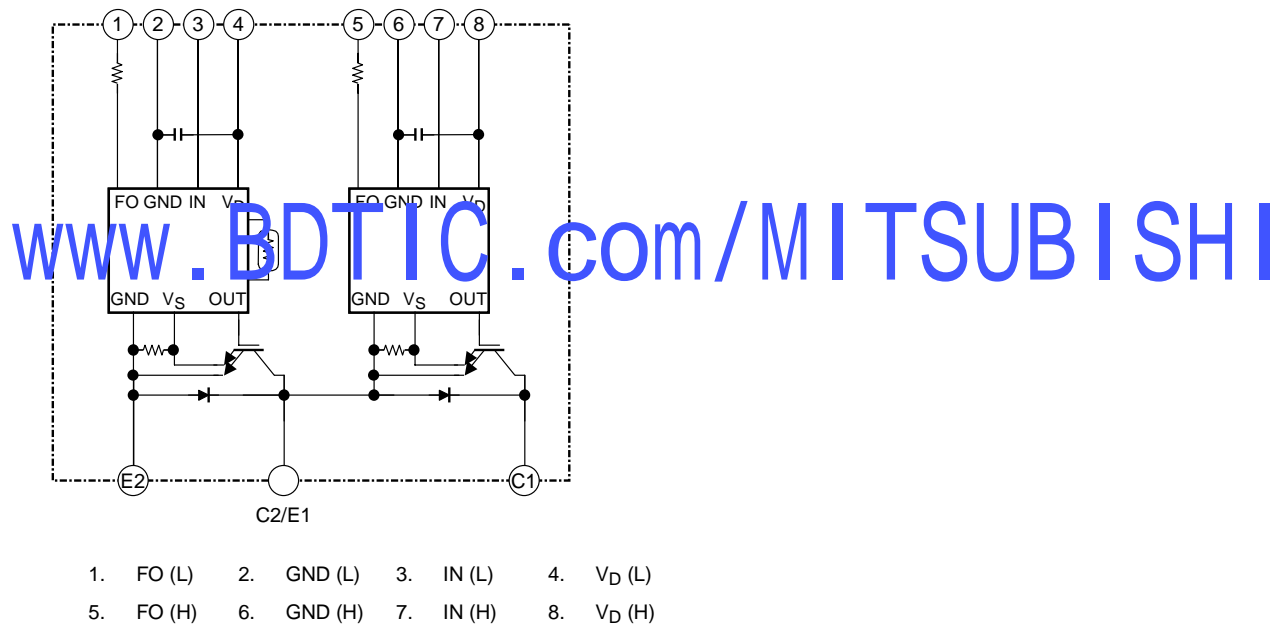

Package Dimensions

Unit: mm

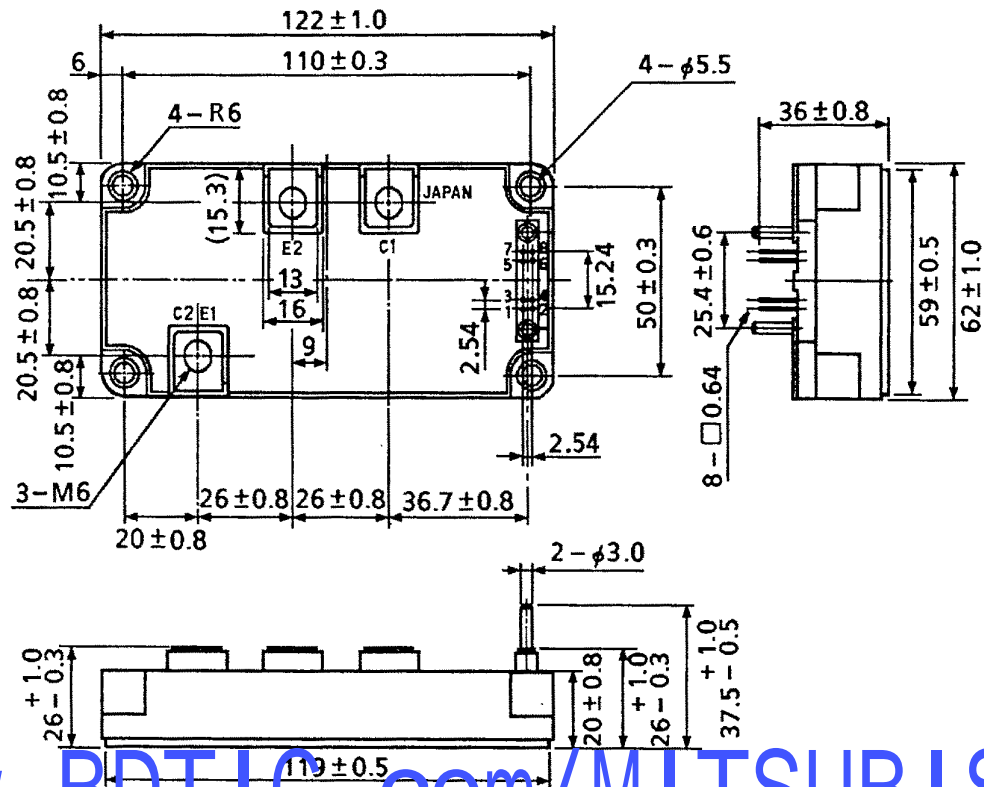

www.BDTIC.com/MITSUBISHI

- | | | | |
|-----------|------------|-----------|-----------------------|
| 1. FO (L) | 2. GND (L) | 3. IN (L) | 4. V _D (L) |
| 5. FO (H) | 6. GND (H) | 7. IN (H) | 8. V _D (H) |

Signal Terminal Layout

Unit: mm

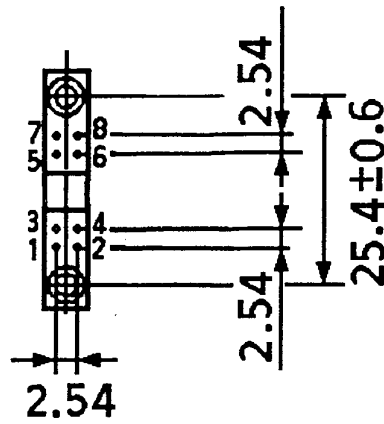

- | | | | |
|-----------|------------|-----------|-----------------------|
| 1. FO (L) | 2. GND (L) | 3. IN (L) | 4. V _D (L) |
| 5. FO (H) | 6. GND (H) | 7. IN (H) | 8. V _D (H) |

www.BDTIC.com/MITSUBISHI

Maximum Ratings ($T_j = 25^\circ\text{C}$)

Stage	Characteristics	Condition	Symbol	Rating	Unit
Inverter	Supply voltage	P-N power terminal	V_{CC}	900	V
	Collector-emitter voltage	—	V_{CES}	1200	V
	Collector current	$T_c = 25^\circ\text{C}$, DC	I_C	300	A
	Forward current	$T_c = 25^\circ\text{C}$, DC	I_F	300	A
	Collector power dissipation	$T_c = 25^\circ\text{C}$	P_C	2840	W
	Junction temperature	—	T_j	150	$^\circ\text{C}$
Control	Control supply voltage	V_D -GND terminal	V_D	20	V
	Input voltage	IN-GND terminal	V_{IN}	20	V
	Fault output voltage	FO-GND terminal	V_{FO}	20	V
	Fault output current	FO sink current	I_{FO}	10	mA
Module	Operating temperature	—	T_c	-20~+100	$^\circ\text{C}$
	Storage temperature	—	T_{stg}	-40~+125	$^\circ\text{C}$
	Isolation voltage	AC 1 min	V_{ISO}	2500	V
	Screw torque (terminal)	M6	—	3	N·m
	Screw torque (mounting)	M5	—	3	N·m

Electrical Characteristics

1. Inverter stage

Characteristics	Symbol	Test Condition	Min	Typ.	Max	Unit	
Collector cut-off current	I_{CEX}	$V_{CE} = 1200\text{ V}$	$T_j = 25^\circ\text{C}$	—	1	mA	
			$T_j = 125^\circ\text{C}$	—	10		
Collector-emitter saturation voltage	$V_{CE(sat)}$	$V_D = 15\text{ V}$ $I_C = 300\text{ A}$ $V_{IN} = 15\text{ V} \rightarrow 0\text{ V}$	$T_j = 25^\circ\text{C}$	—	2.4	2.8	V
			$T_j = 125^\circ\text{C}$	—	2.8	—	
Forward voltage	V_F	$I_F = 300\text{ A}$, $T_j = 25^\circ\text{C}$	—	2.2	2.6	V	
Switching time	t_{on}	$V_{CC} = 600\text{ V}$, $I_C = 300\text{ A}$ $V_D = 15\text{ V}$, $V_{IN} = 15\text{ V} \leftrightarrow 0\text{ V}$ $T_j = 25^\circ\text{C}$, Inductive load (Note 1)	—	2.0	3.0	μs	
	$t_c(\text{on})$		—	0.5	—		
	t_{rr}		—	0.3	—		
	t_{off}		—	1.6	2.5		
	$t_c(\text{off})$		—	0.3	—		

Note 1: Switching time test circuit & timing chart

2. Control stage ($T_j = 25^\circ\text{C}$)

Characteristics		Symbol	Test Condition	Min	Typ.	Max	Unit
Control circuit current	High side	$I_D (H)$	$V_D = 15 \text{ V}$	—	13	17	mA
	Low side	$I_D (L)$		—	13	17	
Input on signal voltage		$V_{IN (on)}$	$V_D = 15 \text{ V}$	1.4	1.6	1.8	V
Input off signal voltage		$V_{IN (off)}$		2.2	2.5	2.8	
Fault output current	Protection	$I_{FO (on)}$	$V_D = 15 \text{ V}$	8	10	12	mA
	Normal	$I_{FO (off)}$		—	—	0.1	
Overcurrent protection trip level		OC	$V_D = 15 \text{ V}, T_j \leq 125^\circ\text{C}$	480	—	—	A
Short-circuit protection trip level		SC	$V_D = 15 \text{ V}, T_j \leq 125^\circ\text{C}$	480	—	—	A
Overcurrent cut-off time		$t_{off (OC)}$	$V_D = 15 \text{ V}$	—	5	—	μs
Overtemperature protection	Trip level	OT	Case temperature	110	118	125	$^\circ\text{C}$
	Reset level	OTr		—	98	—	
Control supply under voltage protection	Trip level	UV	—	11.0	12.0	12.5	V
	Reset level	UVr		12.0	12.5	13.0	
Fault output pulse width		t_{FO}	$V_D = 15 \text{ V}$	1	2	3	ms

3. Thermal resistance ($T_c = 25^\circ\text{C}$)

Characteristics		Symbol	Test Condition	Min	Typ.	Max	Unit
Junction to case thermal resistance		$R_{th (j-c)}$	IGBT	—	—	0.044	$^\circ\text{C/W}$
			FRD	—	—	0.068	
Case to fin thermal resistance		$R_{th (c-f)}$	Compound is applied	—	0.3	—	$^\circ\text{C/W}$

www.BDTIC.com/MITSUBISHI

Switching Time Test Circuit

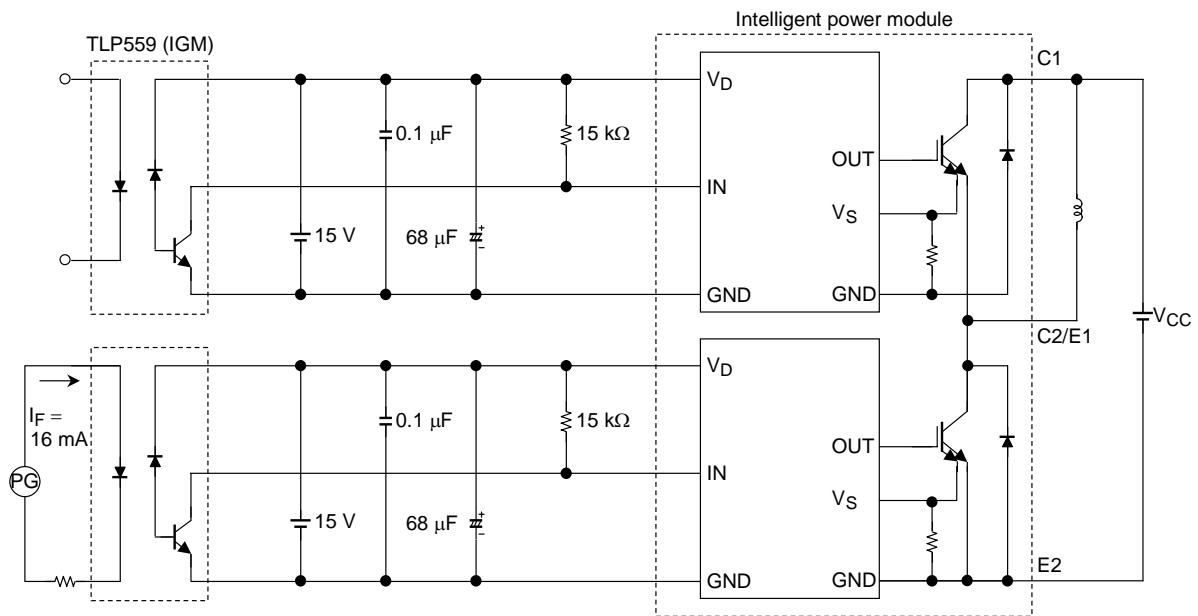

Timing Chart

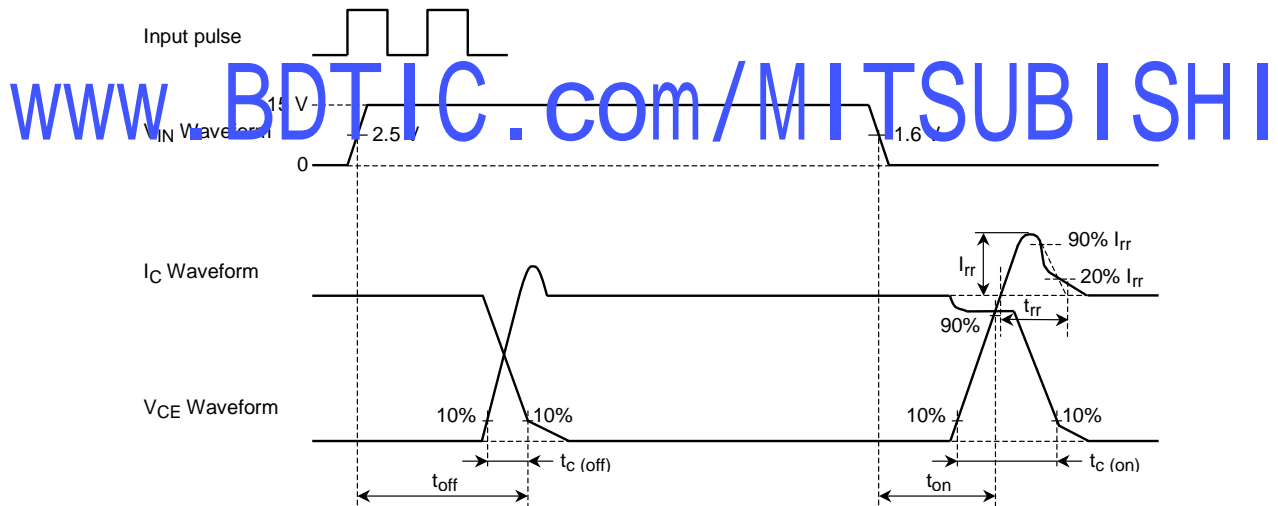

www.BDTIC.com/MITSUBISHI

4. Recommended conditions for application

Characteristics	Symbol	Test Condition	Min	Typ.	Max	Unit
Supply voltage	V_{CC}	P-N power terminal	—	600	800	V
Control supply voltage	V_D	V_D -GND signal terminal	13.5	15	16.5	V
Carrier frequency	f_c	PWM control	—	—	20	kHz
Dead time	t_{dead}	Switching time test circuit (Note 2)	5	—	—	μs

Note 2: The table lists Dead time requirements for the module input, excluding photocoupler delays. When specifying dead time requirements for the photocoupler input, please add photocoupler delays to the dead time given above.

Dead Time Timing Chart

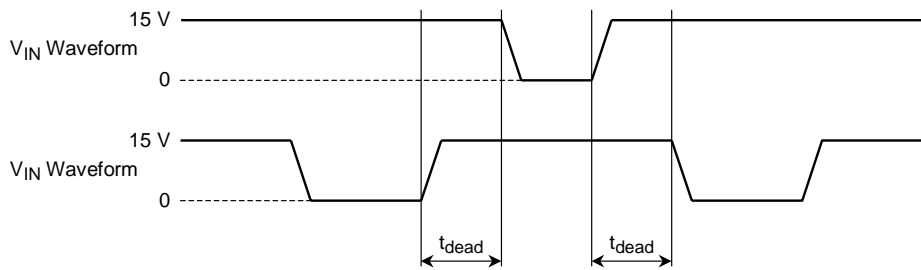

www.BDTIC.com/MITSUBISHI

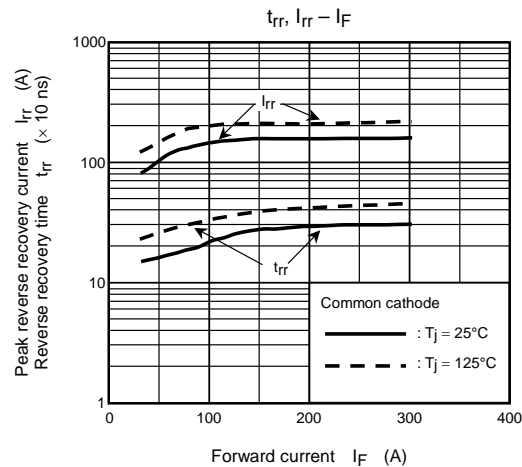
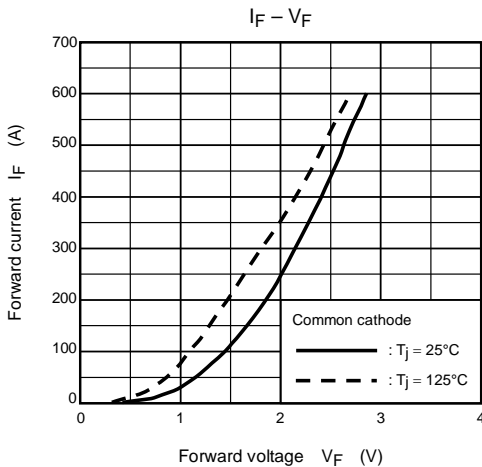
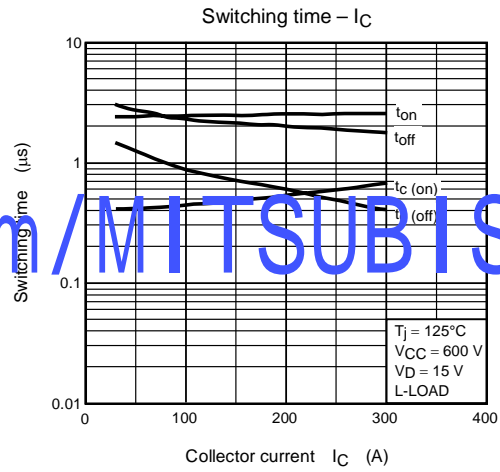
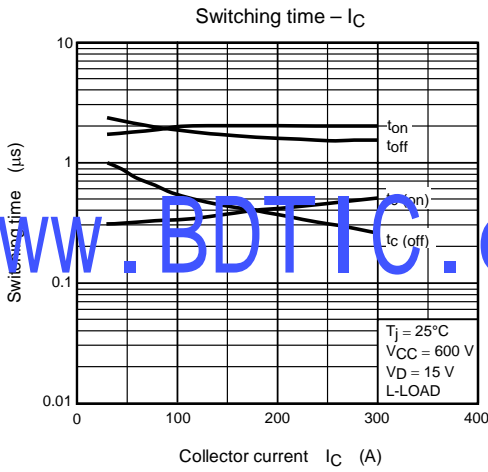
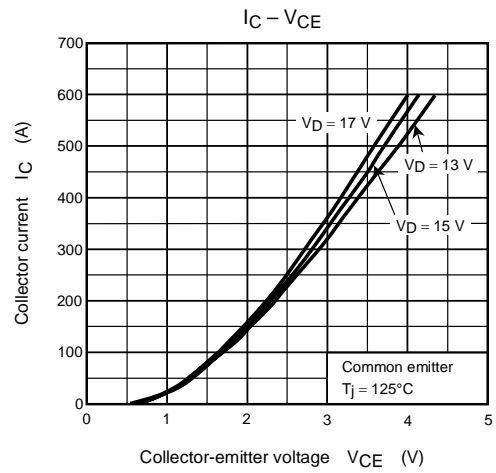
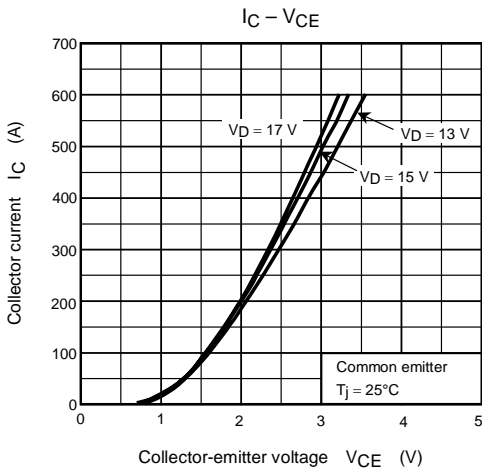

www.BDTIC.com / MITSUBISHI

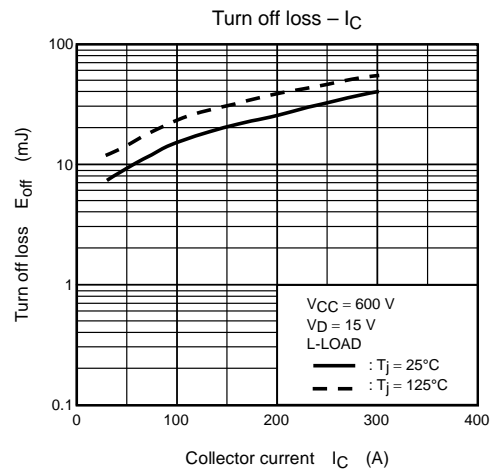
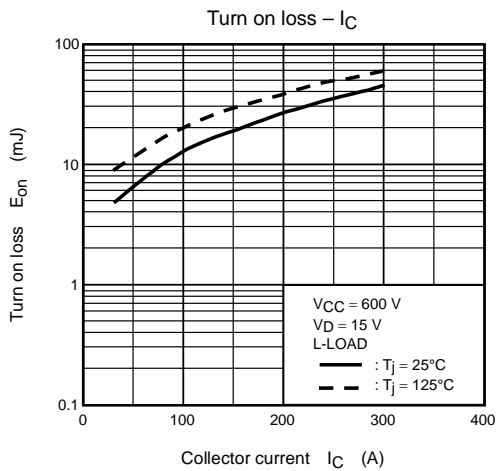
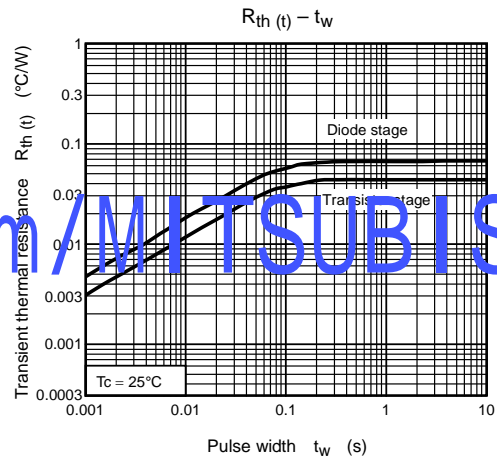
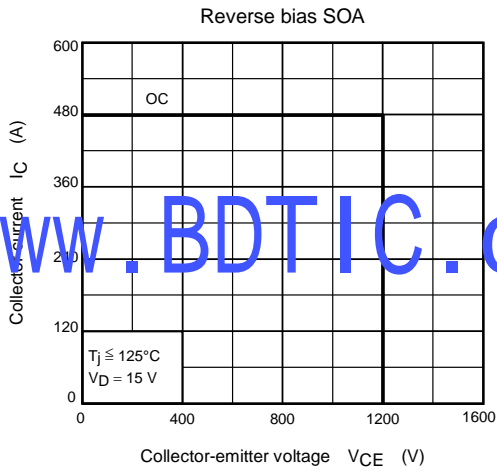
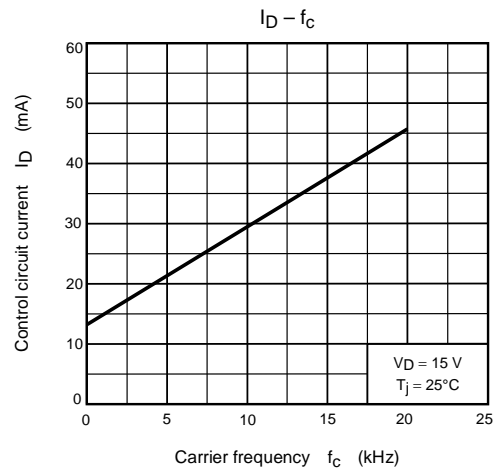
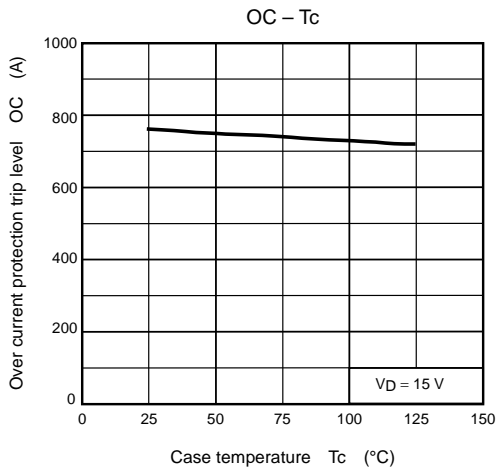

www.BDTIC.com/MITSUBISHI