

MITSUBISHI SEMICONDUCTOR <Intelligent Power Module>

MIG50J6CSB1W (600V/50A 6in1)

High Power Switching Applications

Motor Control Applications

- Integrates inverter, circuit and control circuits (IGBT drive units, and units for protection against short-circuit current, overcurrent, undervoltage and overtemperature) into a single package.
- The electrodes are isolated from the case
- Low thermal resistance
- $V_{CE(sat)} = 1.8\text{ V (typ.)}$
- UL recognized: File No. E87989

Equivalent Circuit

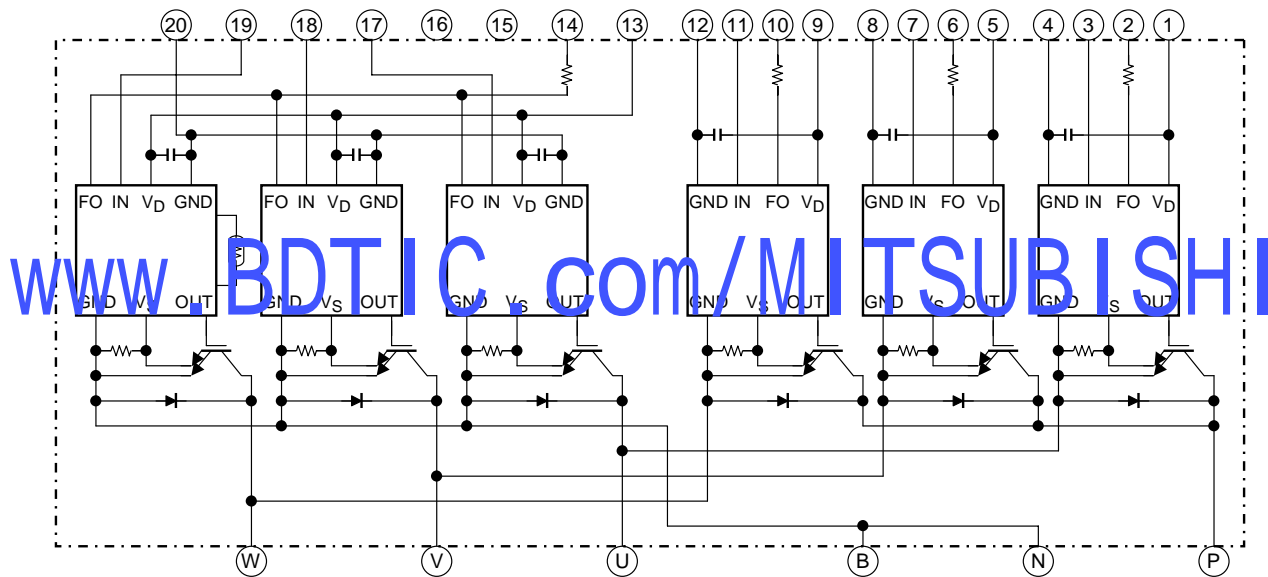

1.	V_D (U)	2.	FO (U)	3.	IN (U)	4.	GND (U)	5.	V_D (V)	6.	FO (V)	7.	IN (V)
8.	GND (V)	9.	V_D (W)	10.	FO (W)	11.	IN (W)	12.	GND (W)	13.	V_D (L)	14.	FO (L)
15.	Open	16.	Open	17.	IN (X)	18.	IN (Y)	19.	IN (Z)	20.	GND (L)		

Signal Terminal Layout

Unit: mm

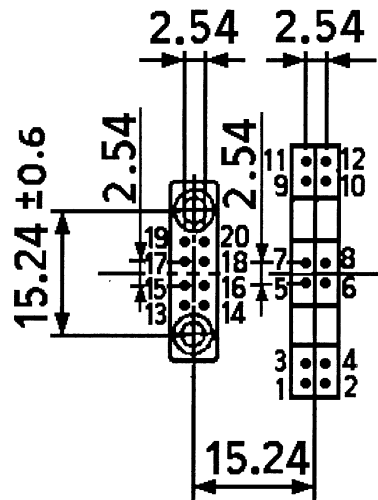

- | | | | | | |
|---------------|-------------|--------------|------------|--------------|-------------|
| 1. V_D (U) | 2. FO (U) | 3. IN (U) | 4. GND (U) | 5. V_D (V) | 6. FO (V) |
| 7. IN (V) | 8. GND (V) | 9. V_D (W) | 10. FO (W) | 11. IN (W) | 12. GND (W) |
| 13. V_D (L) | 14. FO (L) | 15. Open | 16. Open | 17. IN (X) | 18. IN (Y) |
| 19. IN (Z) | 20. GND (L) | | | | |

www.BDTIC.com/MITSUBISHI

Maximum Ratings ($T_j = 25^\circ\text{C}$)

Stage	Characteristic	Condition	Symbol	Rating	Unit
Inverter	Supply voltage	P-N Power terminal	V_{CC}	450	V
	Collector-emitter voltage	—	V_{CES}	600	V
	Collector current	$T_c = 25^\circ\text{C}$, DC	I_C	50	A
	Forward current	$T_c = 25^\circ\text{C}$, DC	I_F	50	A
	Collector power dissipation	$T_c = 25^\circ\text{C}$, DC	P_C	340	W
	Junction temperature	—	T_j	150	$^\circ\text{C}$
Control	Control supply voltage	V_D -GND Terminal	V_D	20	V
	Input voltage	IN-GND Terminal	V_{IN}	20	V
	Fault output voltage	FO-GND Terminal	V_{FO}	20	V
	Fault output current	FO sink current	I_{FO}	14	mA
Module	Operating temperature	—	T_c	-20~+100	$^\circ\text{C}$
	Storage temperature range	—	T_{stg}	-40~+125	$^\circ\text{C}$
	Isolation voltage	AC 1 min	V_{ISO}	2500	V
	Screw torque (Terminal)	M4	—	2	N·m
	Screw torque (Mounting)	M5	—	3	

Electrical Characteristics

1. Inverter stage

Characteristics	Symbol	Test Condition	Min	Typ.	Max	Unit	
Collector cut-off current	I_{CEX}	$V_{CE} = 600\text{ V}$	$T_j = 25^\circ\text{C}$	—	1	mA	
			$T_j = 125^\circ\text{C}$	—	10		
Collector-emitter saturation voltage	$V_{CE(sat)}$	$V_D = 15\text{ V}$ $I_C = 50\text{ A}$ $V_{IN} = 15\text{ V} \rightarrow 0\text{ V}$	$T_j = 25^\circ\text{C}$	1.5	1.8	2.2	V
			$T_j = 125^\circ\text{C}$	—	2.0	—	
Forward voltage	V_F	$I_F = 50\text{ A}$, $T_j = 25^\circ\text{C}$	—	2.0	2.5	V	
Switching time	t_{on}	$V_{CC} = 300\text{ V}$, $I_C = 50\text{ A}$ $V_D = 15\text{ V}$, $V_{IN} = 15\text{ V} \leftrightarrow 0\text{ V}$ $T_j = 25^\circ\text{C}$, Inductive load (Note 1)	—	1.3	2.2	μs	
	$t_c(\text{on})$		—	0.25	—		
	t_{rr}		—	0.2	—		
	t_{off}		—	1.1	2.1		
	$t_c(\text{off})$		—	0.2	—		

Note 1: Switching time test circuit and timing chart

2. Control stage ($T_j = 25^\circ\text{C}$)

Characteristics		Symbol	Test Condition	Min	Typ.	Max	Unit
Control circuit current	High side	$I_D (H)$	$V_D = 15\text{ V}$	—	13	17	mA
	Low side	$I_D (L)$		—	39	51	
Input on signal voltage		$V_{IN (on)}$	$V_D = 15\text{ V}$	1.4	1.6	1.8	V
Input off signal voltage		$V_{IN (off)}$		2.2	2.5	2.8	
Fault output current	Protection	$I_{FO (on)}$	$V_D = 15\text{ V}$	—	10	12	mA
	Normal	$I_{FO (off)}$		—	—	0.1	
Over current protection trip level	Inverter	OC	$V_D = 15\text{ V}, T_j \leq 125^\circ\text{C}$	80	—	—	A
Short circuit protection trip level	Inverter	SC	$V_D = 15\text{ V}, T_j \leq 125^\circ\text{C}$	80	—	—	A
Over current cut-off time		$t_{off (OC)}$	$V_D = 15\text{ V}$	—	5	—	μs
Over temperature protection	Trip level	OT	Case temperature	110	118	125	$^\circ\text{C}$
	Reset level	OTr		—	98	—	
Control supply under voltage protection	Trip level	UV	—	11.0	12.0	12.5	V
	Reset level	UVr		12.0	12.5	13.0	
Fault output pulse width		t_{FO}	$V_D = 15\text{ V}$	1	2	3	ms

3. Thermal resistance ($T_c = 25^\circ\text{C}$)

Characteristics		Symbol	Test Condition	Min	Typ.	Max	Unit
Junction to case thermal resistance		$R_{th (j-c)}$	IGBT	—	—	0.360	$^\circ\text{C/W}$
			FRD	—	—	0.550	
Case to fin thermal resistance		$R_{th (c-f)}$	Compound is applied	—	0.17	—	$^\circ\text{C/W}$

www.BDTIC.com/MITSUBISHI

Switching Time Test Circuit

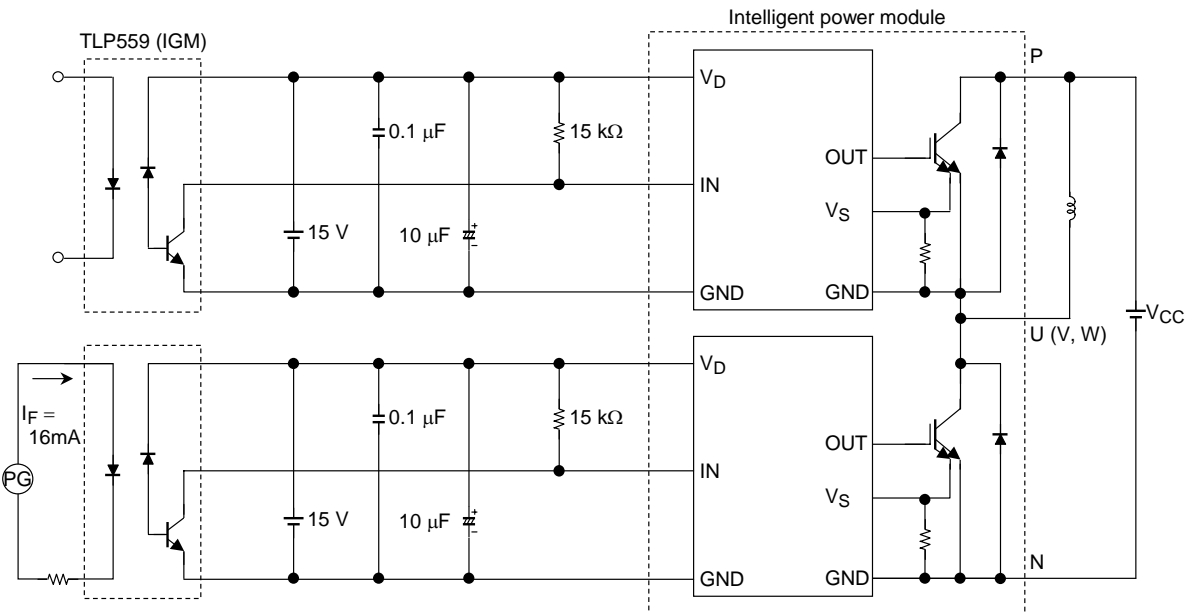

Timing Chart

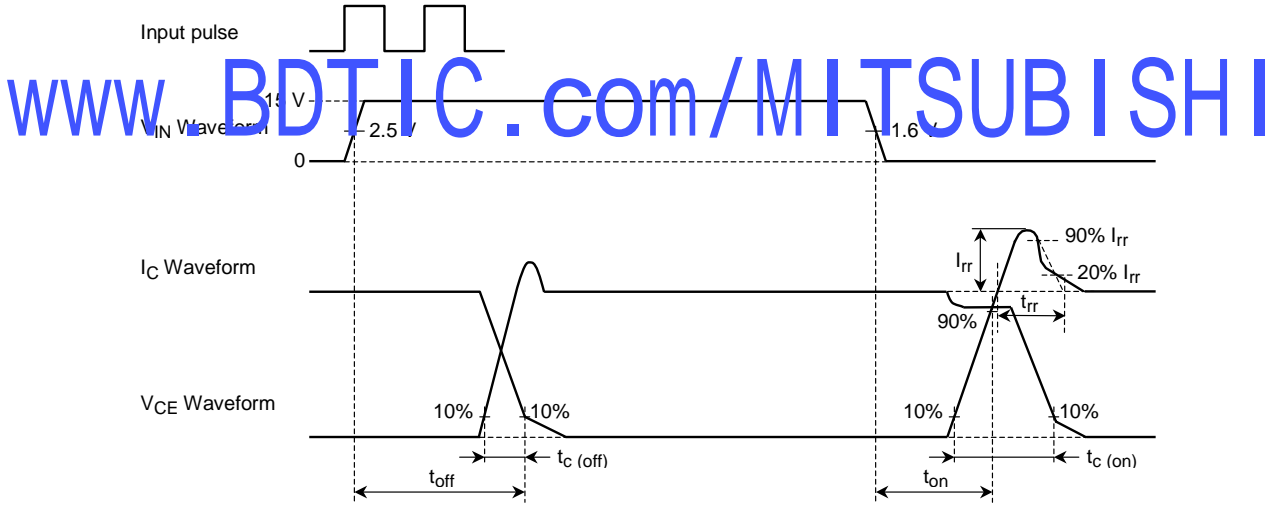

4. Recommended conditions for application

Characteristics	Symbol	Test Condition	Min	Typ.	Max	Unit
Supply voltage	V_{CC}	P-N Power terminal	—	300	400	V
Control supply voltage	V_D	V_D -GND Signal terminal	13.5	15	16.5	V
Carrier frequency	f_c	PWM Control	—	—	20	kHz
Dead time	t_{dead}	Switching time test circuit (See page.6) (Note 2)	3	—	—	μs

Note 2: The table lists Dead time requirements for the module input, excluding photocoupler delays. When specifying dead time requirements for the photocoupler input, please add photocoupler delays to the dead time given above.

Dead Time Timing Chart

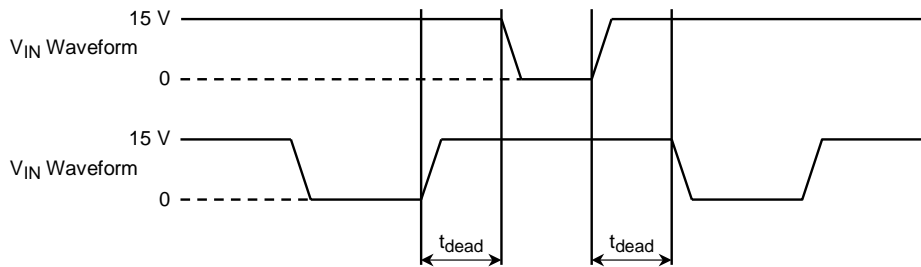

www.BDTIC.com/MITSUBISHI

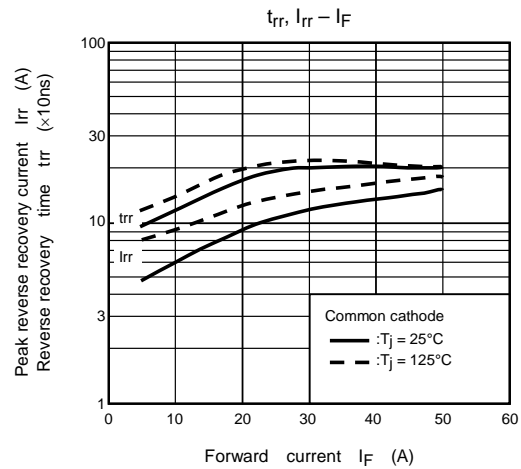
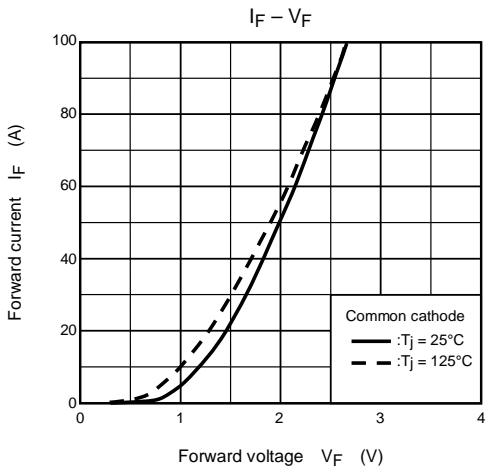
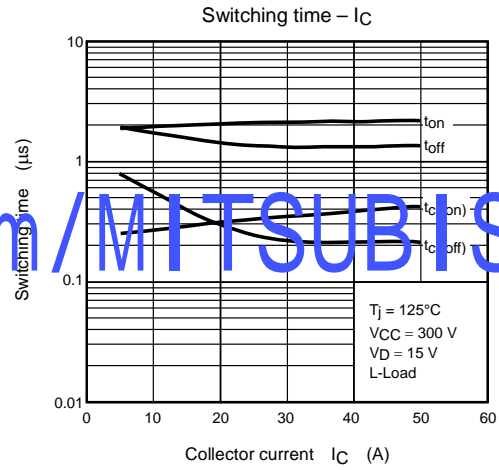
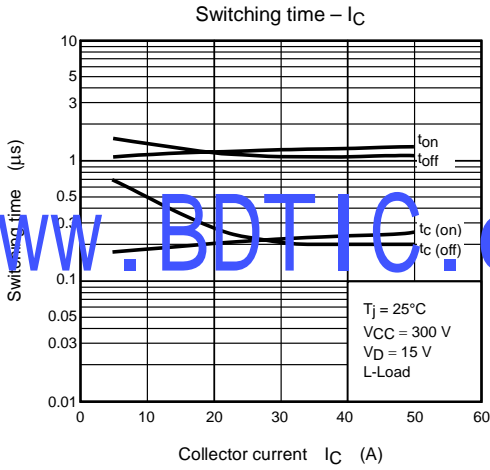
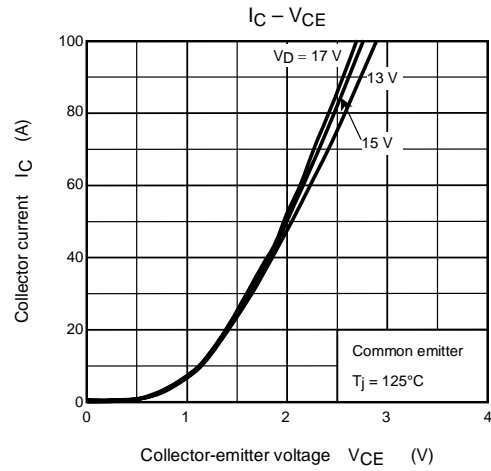
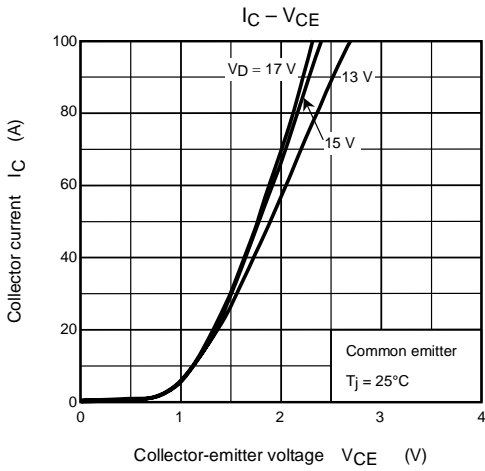

www.BDTIC.com/MITSUBISHI

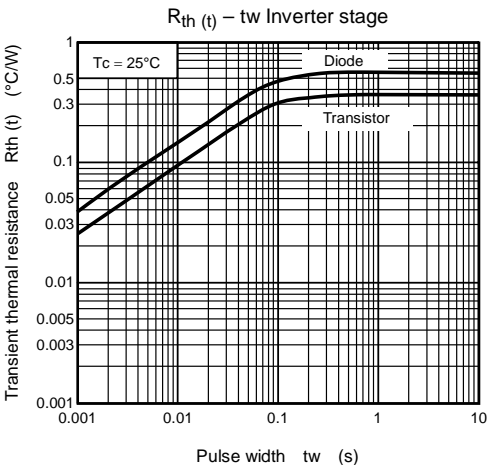
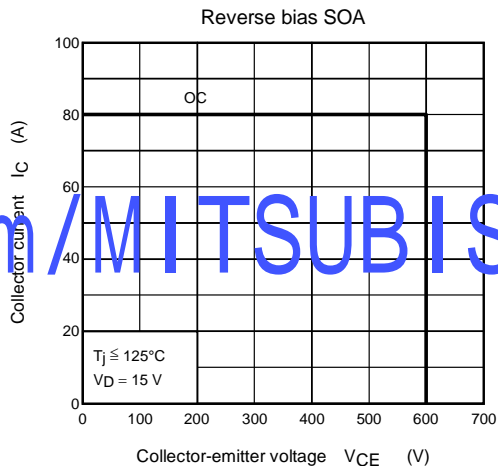
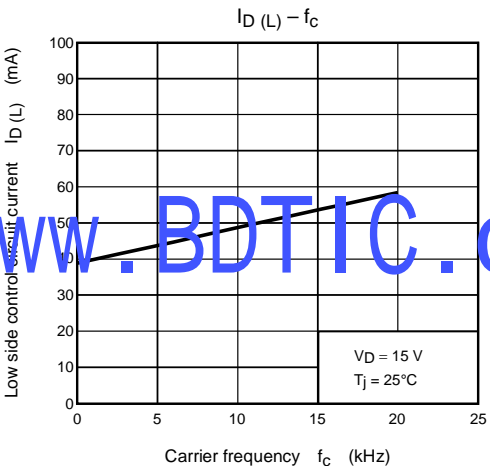
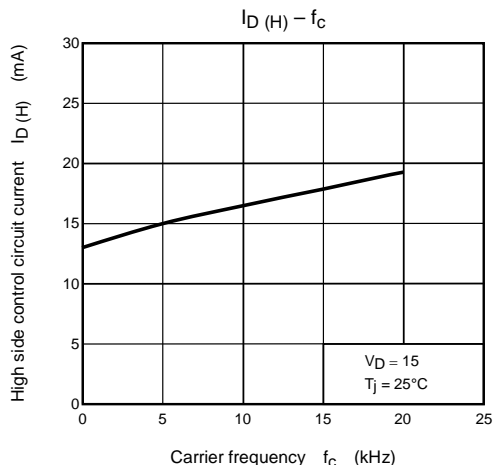
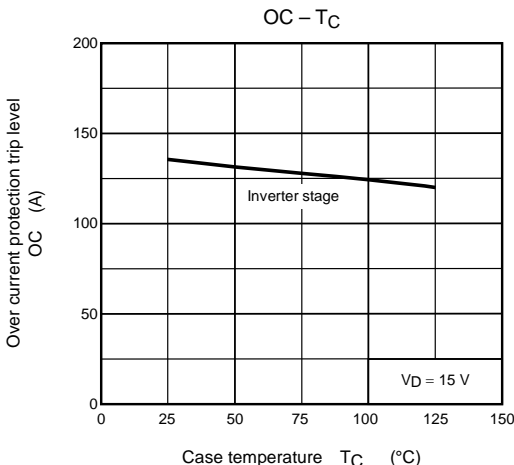

www.BDTIC.com / MITSUBISHI

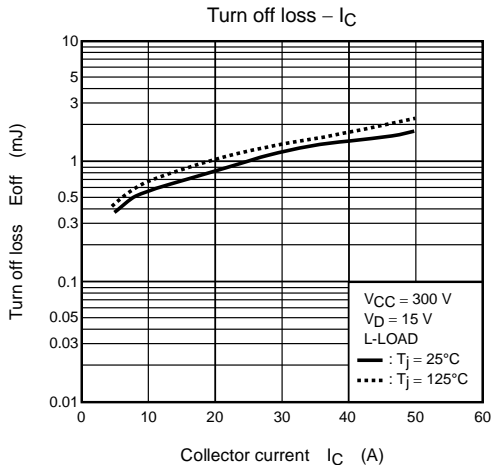
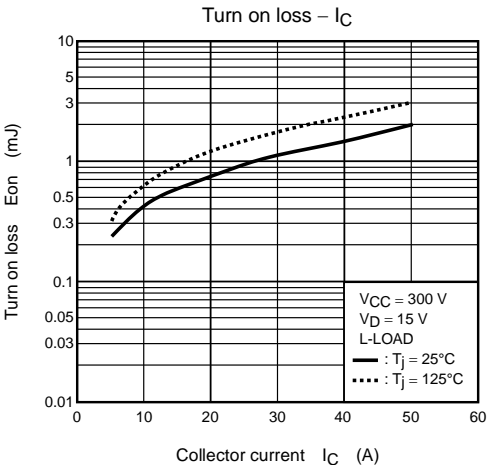

www.BDTIC.com/MITSUBISHI