

MITSUBISHI SEMICONDUCTOR <Intelligent Power Module>

MIG75Q7CSB1X (1200V/75A 7in1)

High Power Switching Applications

Motor Control Applications

- Integrates inverter, brake power circuits and control circuits (IGBT drive units, protection units for short-circuit current, over current, under voltage and over temperature) in one package.
- The electrodes are isolated from case.
- $V_{CE(sat)} = 2.2\text{ V (typ.)}$
- UL recognized File No. E87989
- Weight: 278 g (typ.)

Equivalent Circuit

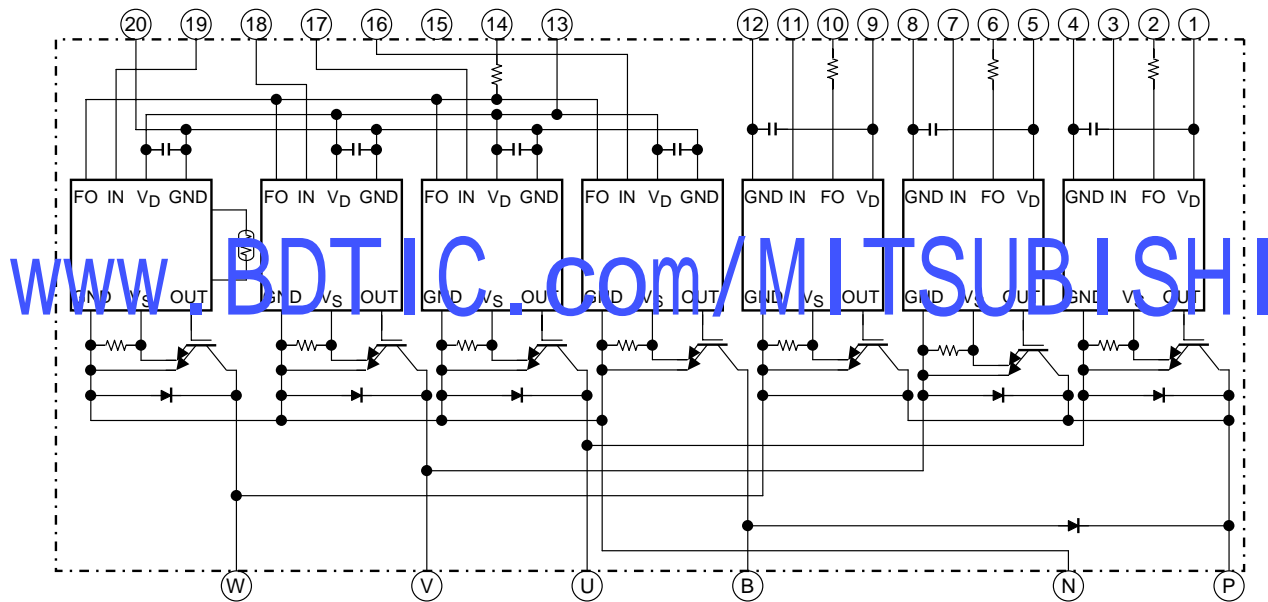

1. V_D (U)	2. FO (U)	3. IN (U)	4. GND (U)	5. V_D (V)	6. FO (V)	7. IN (V)
8. GND (V)	9. V_D (W)	10. FO (W)	11. IN (W)	12. GND (W)	13. V_D (L)	14. FO (L)
15. Open	16. IN (B)	17. IN (X)	18. IN (Y)	19. IN (Z)	20. GND (L)	

Package Dimensions

Unit: mm

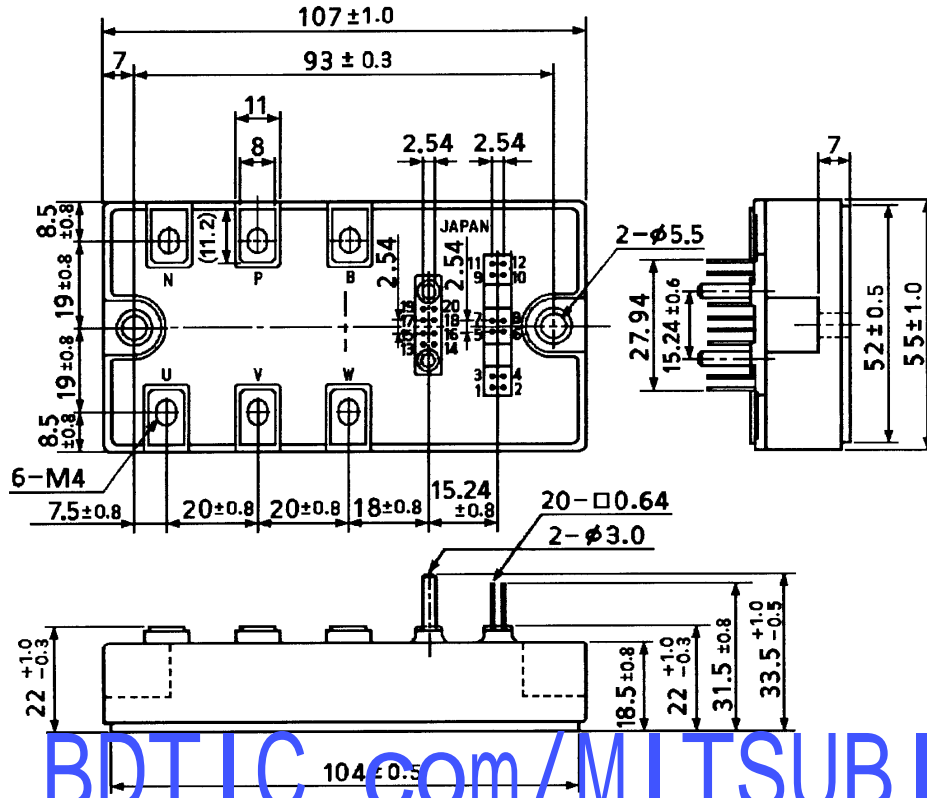

www.BDTIC.com/MITSUBISHI

- | | | | | | |
|------------------------|-------------|-----------------------|------------|-----------------------|-------------|
| 1. V _D (U) | 2. FO (U) | 3. IN (U) | 4. GND (U) | 5. V _D (V) | 6. FO (V) |
| 7. IN (V) | 8. GND (V) | 9. V _D (W) | 10. FO (W) | 11. IN (W) | 12. GND (W) |
| 13. V _D (L) | 14. FO (L) | 15. Open | 16. IN (B) | 17. IN (X) | 18. IN (Y) |
| 19. IN (Z) | 20. GND (L) | | | | |

Signal Terminal Layout

Unit: mm

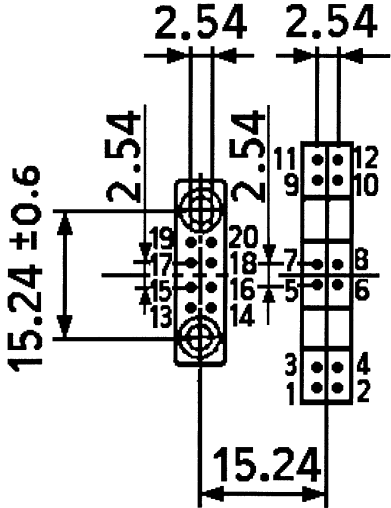

www.BDTIC.com/MITSUBISHI

- 1. V_D (U) 2. FC (U) 3. IN (U) 4. GND (U) 5. V_D (V) 6. FO (V)
- 7. IN (V) 8. GND (V) 9. V_D (W) 10. FO (W) 11. IN (W) 12. GND (W)
- 13. V_D (L) 14. FO (L) 15. Open 16. IN (B) 17. IN (X) 18. IN (Y)
- 19. IN (Z) 20. GND (L)

Maximum Ratings ($T_j = 25^\circ\text{C}$)

Stage	Characteristic	Condition	Symbol	Rated	Unit
Inverter	Supply voltage	P-N power terminal	V_{CC}	900	V
	Collector-emitter voltage	—	V_{CES}	1200	V
	Collector current	$T_c = 25^\circ\text{C}$, DC	I_C	75	A
	Forward current	$T_c = 25^\circ\text{C}$, DC	I_F	75	A
	Collector power dissipation	$T_c = 25^\circ\text{C}$	P_C	830	W
	Junction temperature	—	T_j	150	$^\circ\text{C}$
Brake	Supply voltage	P-N power terminal	V_{CC}	900	V
	Collector-emitter voltage	—	V_{CES}	1200	V
	Collector current	$T_c = 25^\circ\text{C}$, DC	I_C	40	A
	Reverse voltage	—	V_R	1200	V
	Forward current	$T_c = 25^\circ\text{C}$, DC	I_F	40	A
	Collector power dissipation	$T_c = 25^\circ\text{C}$	P_C	500	W
	Junction temperature	—	T_j	150	$^\circ\text{C}$
Control	Control supply voltage	V_D -GND terminal	V_D	20	V
	Input voltage	IN-GND terminal	V_{IN}	20	V
	Fault output voltage	FO-GND terminal	V_{FO}	20	V
	Fault output current	FO sink current	I_{FO}	14	mA
Module	Operating temperature	—	T_c	-20~+100	$^\circ\text{C}$
	Storage temperature range	—	T_{stg}	-40~+125	$^\circ\text{C}$
	Insulation voltage	AC 1 minute	V_{SO}	2500	V
	Screw torque (terminal)	M4	—	—	N·m
	Screw torque (mounting)	M5	—	3	N·m

Electrical Characteristics

1. Inverter Stage

Characteristic	Symbol	Test Condition		Min	Typ.	Max	Unit
		$V_{CE} = 1200\text{ V}$	$T_j = 25^\circ\text{C}$				
Collector cut-off current	I_{CEX}	$V_{CE} = 1200\text{ V}$	$T_j = 25^\circ\text{C}$	—	—	1	mA
			$T_j = 125^\circ\text{C}$	—	—	10	
Collector-emitter saturation voltage	$V_{CE(sat)}$	$V_D = 15\text{ V}$, $I_C = 75\text{ A}$, $V_{IN} = 15\text{ V} \rightarrow 0\text{ V}$	$T_j = 25^\circ\text{C}$	—	2.2	2.6	V
			$T_j = 125^\circ\text{C}$	—	—	3.0	
Forward voltage	V_F	$I_F = 75\text{ A}$, $T_j = 25^\circ\text{C}$		—	2.4	2.8	V
Switching time	t_{on}	$V_{CC} = 600\text{ V}$, $I_C = 75\text{ A}$, $V_D = 15\text{ V}$, $V_{IN} = 15\text{ V} \leftrightarrow 0\text{ V}$, $T_j = 25^\circ\text{C}$, Inductive load (Note 1)		—	2.0	3.0	μs
	$t_c(on)$			—	0.3	—	
	t_{rr}			—	0.3	—	
	t_{off}			—	1.5	2.5	
	$t_c(off)$			—	0.4	—	

Note 1: Switching time test circuit and timing chart.

2. Brake Stage

Characteristic	Symbol	Test Condition	Min	Typ.	Max	Unit	
Collector cut-off current	I_{CEX}	$V_{CE} = 1200\text{ V}$	$T_j = 25^\circ\text{C}$	—	—	1	mA
			$T_j = 125^\circ\text{C}$	—	—	10	
Collector-emitter saturation voltage	$V_{CE(sat)}$	$V_D = 15\text{ V},$ $I_C = 40\text{ A},$ $V_{IN} = 15\text{ V} \rightarrow 0\text{ V}$	$T_j = 25^\circ\text{C}$	—	2.2	2.6	V
			$T_j = 125^\circ\text{C}$	—	—	3.0	
Reverse current	I_R	$V_R = 1200\text{ V}$	$T_j = 25^\circ\text{C}$	—	—	1	mA
			$T_j = 125^\circ\text{C}$	—	—	10	
Forward voltage	V_F	$I_F = 40\text{ A}, T_j = 25^\circ\text{C}$	—	1.7	2.1	V	
Switching time	t_{on}	$V_{CC} = 600\text{ V}, I_C = 40\text{ A},$ $V_D = 15\text{ V}, V_{IN} = 15\text{ V} \leftrightarrow 0\text{ V},$ $T_j = 25^\circ\text{C},$ Inductive load (Note 1)	—	2.0	3.0	μs	
	$t_c(\text{on})$		—	0.75	—		
	t_{rr}		—	0.7	—		
	t_{off}		—	1.5	2.5		
	$t_c(\text{off})$		—	0.3	—		

Note 1: Switching time test circuit and timing chart.

3. Control Stage ($T_j = 25^\circ\text{C}$)

Characteristic	Symbol	Test Condition	Min	Typ.	Max	Unit	
Control circuit current	High side	$I_D(H)$	$V_D = 15\text{ V}$	—	13	17	mA
	Low side			$I_D(L)$	—	52	
Input-on signal voltage	$V_{IN(on)}$	$V_D = 15\text{ V}$	1.4	1.6	1.8	V	
Input-off signal voltage	$V_{IN(off)}$	$V_D = 15\text{ V}$	2.2	2.3	2.8	V	
Fault output current	Protection	$I_{FO(on)}$	$V_D = 15\text{ V}$	8	10	12	mA
	Normal			$I_{FO(off)}$	—	—	
Over current protection trip level	Inverter	OC	$V_D = 15\text{ V}, T_j \leq 125^\circ\text{C}$	120	—	—	A
	Brake			65	—	—	
Short-circuit current protection trip level	Inverter	SC	$V_D = 15\text{ V}, T_j \leq 125^\circ\text{C}$	120	—	—	A
	Brake			65	—	—	
Over current cut-off time	$t_{off(OC)}$	$V_D = 15\text{ V}$	—	5	—	μs	
Over temperature protection	Trip level	OT	Case temperature	110	118	125	$^\circ\text{C}$
	Reset level			OTr	—	98	
Control supply under voltage protection	Trip level	UV	—	11.0	12.0	12.5	V
	Reset level			UVr	12.0	12.5	
Fault output pulse width	t_{FO}	$V_D = 15\text{ V}$	1	2	3	ms	

4. Thermal Resistance ($T_c = 25^\circ\text{C}$)

Characteristic	Symbol	Test Condition	Min	Typ.	Max	Unit
Junction to case thermal resistance	$R_{th(j-c)}$	Inverter IGBT stage	—	—	0.15	$^\circ\text{C/W}$
		Inverter FRD stage	—	—	0.35	
		Brake IGBT stage	—	—	0.25	
		Brake FRD stage	—	—	0.6	
Case to fin thermal resistance	$R_{th(c-f)}$	Compound is applied	—	0.017	—	$^\circ\text{C/W}$

Switching Time Test Circuit

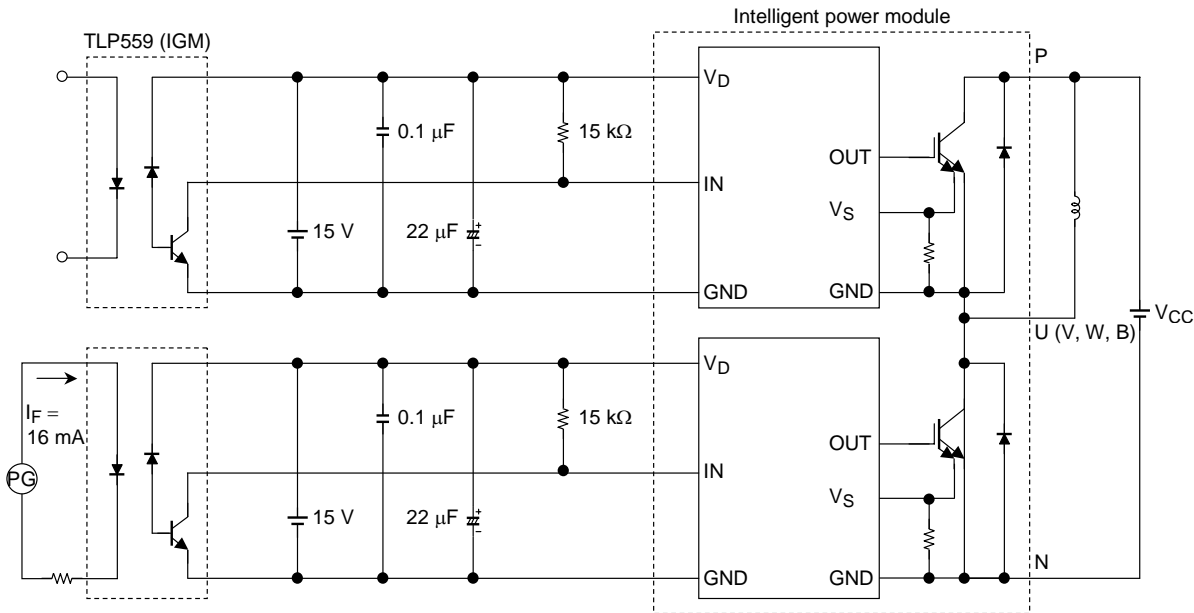

Timing Chart

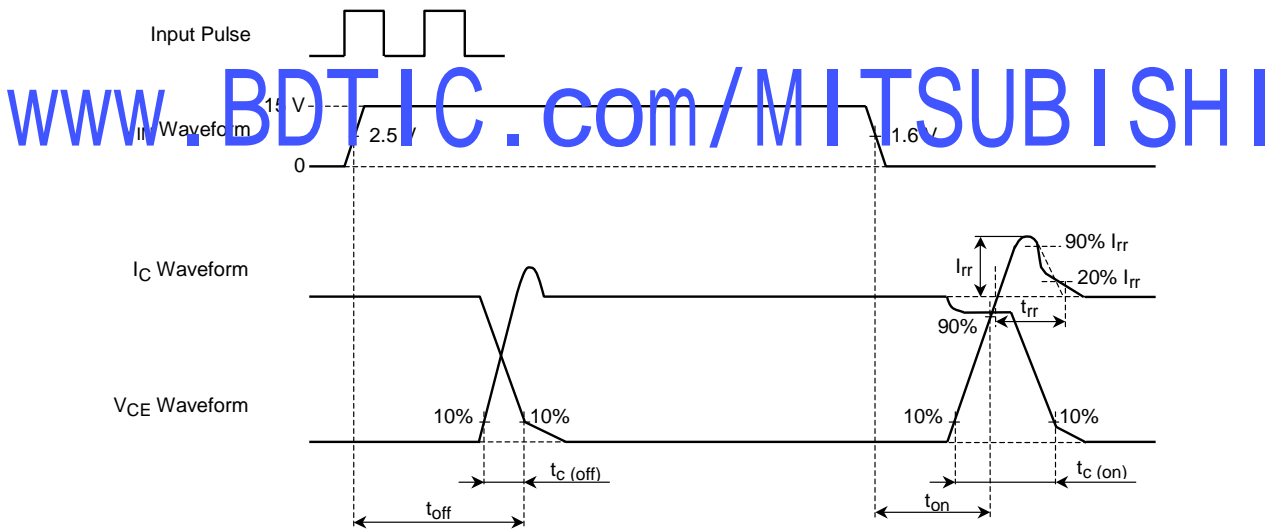

www.BDTIC.com/MITSUBISHI

5. Recommended conditions for application

Characteristic	Symbol	Test Condition	Min	Typ.	Max	Unit
Supply voltage	V_{CC}	P-N Power terminal	—	600	800	V
Control supply voltage	V_D	V_D -GND Signal terminal	13.5	15	16.5	V
Carrier frequency	f_c	PWM Control	—	—	20	kHz
Dead time	t_{dead}	Switching time test circuit (see page.6) (Note 2)	3	—	—	μs

Note 2: The table lists Dead time requirements for the module input, excluding photocoupler delays. When specifying dead time requirements for the photocoupler input, please add photocoupler delays to the dead time given above.

Dead Time Timing Chart

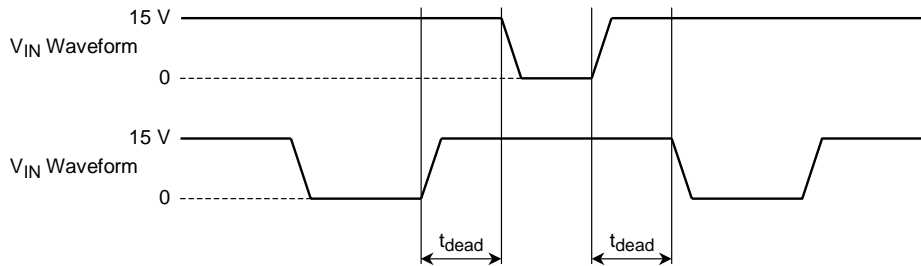

www.BDTIC.com/MITSUBISHI

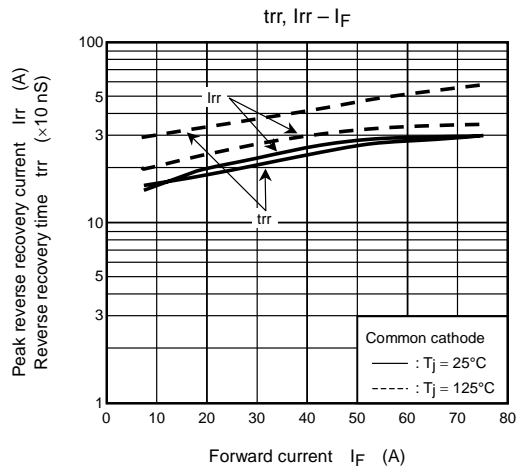
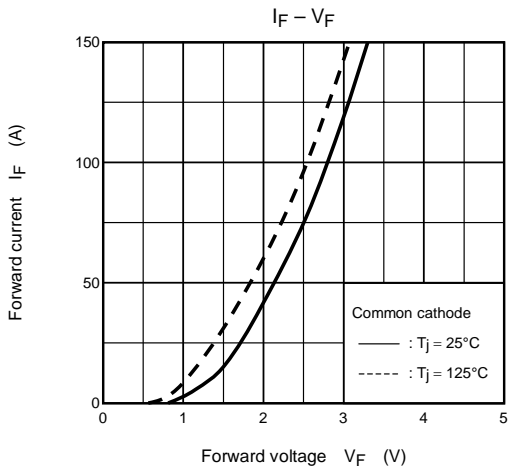
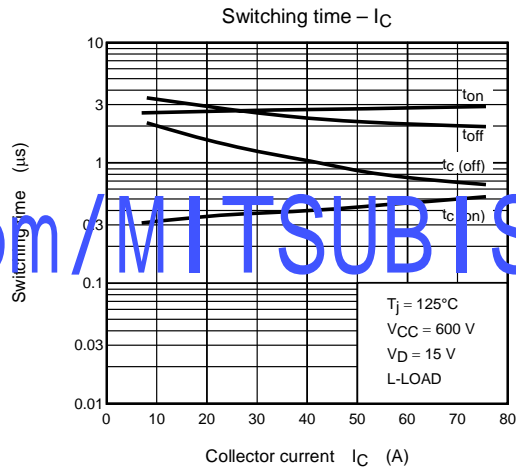
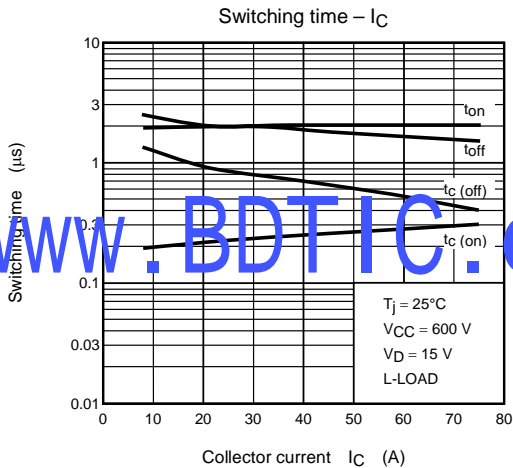
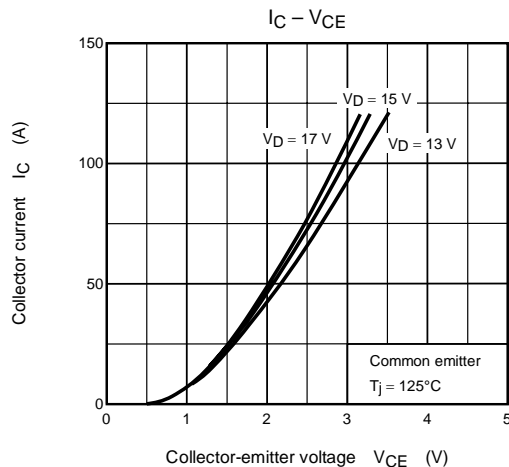
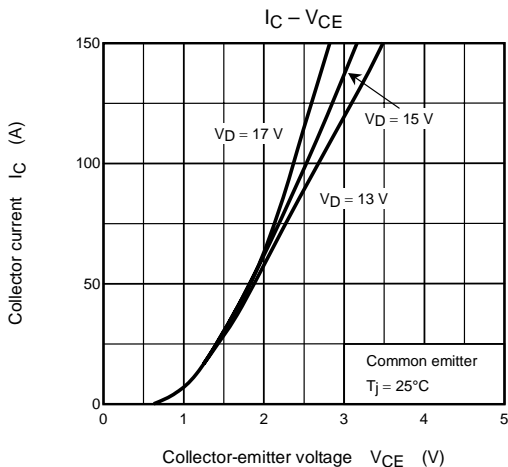

www.BDTIC.com/MITSUBISHI

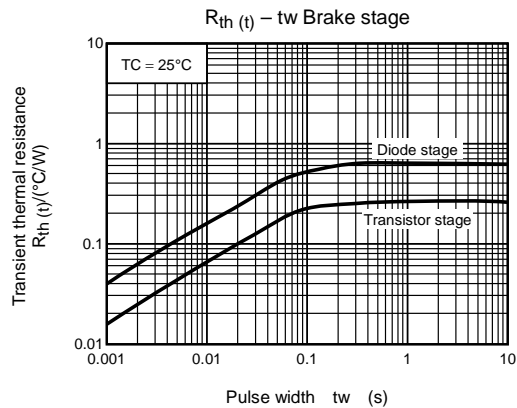
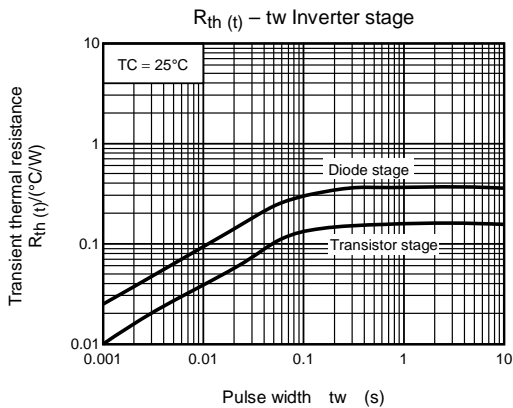
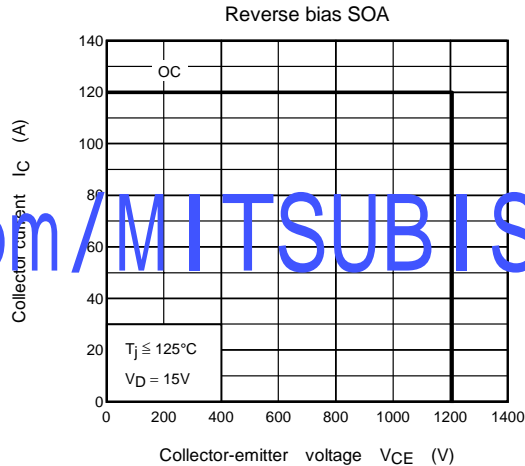
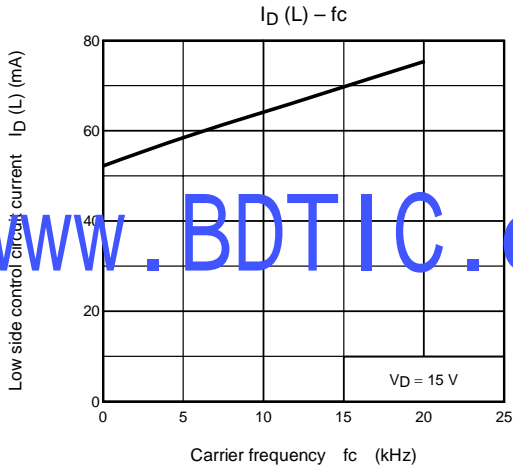
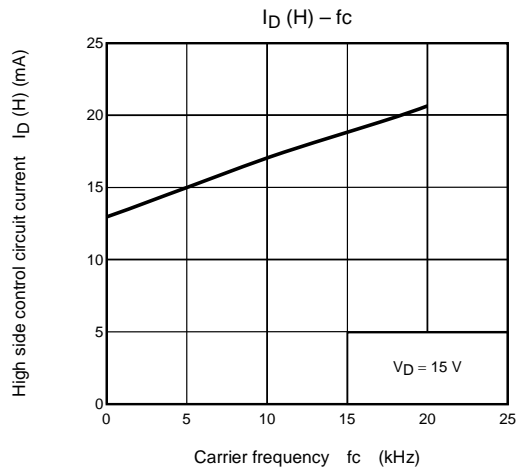
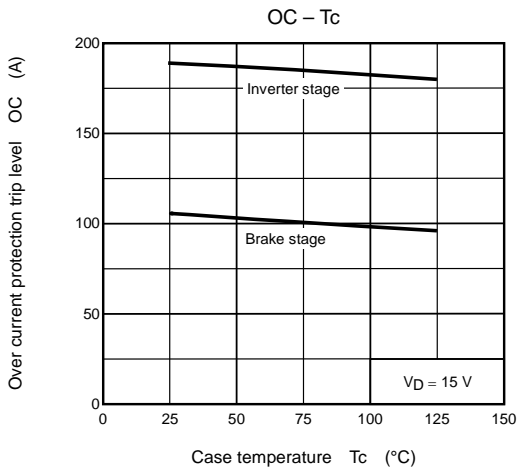

www.BDTIC.com/MITSUBISHI

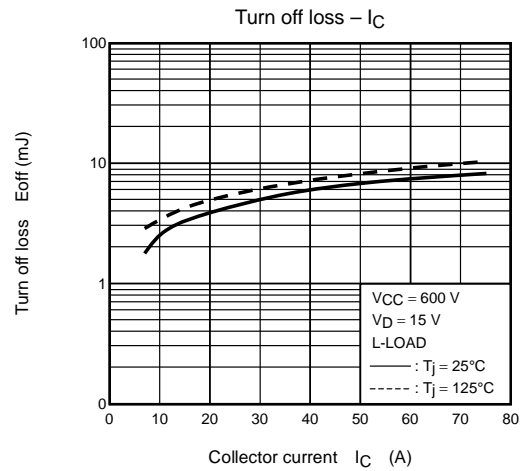
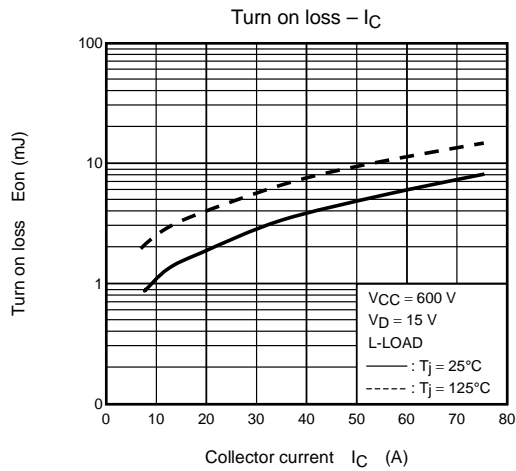

www.BDTIC.com/MITSUBISHI