

**ELECTROSTATIC SENSITIVE DEVICE**  
OBSERVE HANDLING PRECAUTIONS

MITSUBISHI RF POWER MOS FET

# RD45HMF1

RoHS Compliance, Silicon MOSFET Power Transistor 900MHz,45W

## DESCRIPTION

RD45HMF1 is a MOS FET type transistor specifically designed for 900MHz-band High power amplifiers applications.

## FEATURES

High power and High Gain:  
Pout>45W, Gp>4.7dB @Vdd=12.5V,f=900MHz  
High Efficiency: 50%typ.

## APPLICATION

For output stage of high power amplifiers in 800-900MHz Band mobile radio sets.

## RoHS COMPLIANT

RD45HMF1-101 is a RoHS compliant products.  
RoHS compliance is indicate by the letter "G" after the Lot Marking.

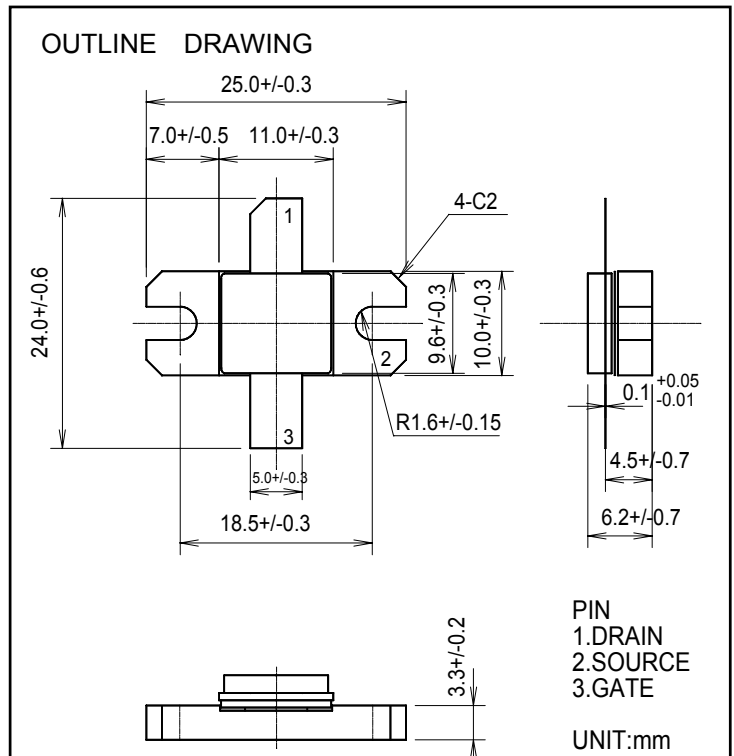

## ABSOLUTE MAXIMUM RATINGS (Tc=25°C UNLESS OTHERWISE NOTED)

SYMBOL	PARAMETER	CONDITIONS	RATINGS	UNIT
V <sub>DSS</sub>	Drain to source voltage	V <sub>GS</sub> =0V	30	V
V <sub>GSS</sub>	Gate to source voltage	V <sub>DS</sub> =0V	+/-20	V
P <sub>ch</sub>	Channel dissipation	T <sub>c</sub> =25°C	125	W
P <sub>in</sub>	Input power	Z <sub>g</sub> =Z <sub>l</sub> =50Ω	25	W
I <sub>D</sub>	Drain current	-	15	A
T <sub>ch</sub>	Channel temperature	-	175	°C
T <sub>stg</sub>	Storage temperature	-	-40 to +175	°C
R <sub>th j-c</sub>	Thermal resistance	junction to case	1.2	°C/W

Note 1: Above parameters are guaranteed independently.

## ELECTRICAL CHARACTERISTICS (Tc=25°C UNLESS OTHERWISE NOTED)

SYMBOL	PARAMETER	CONDITIONS	LIMITS			UNIT
			MIN	TYP	MAX.	
I <sub>DSS</sub>	Zerogate voltage drain current	V <sub>DS</sub> =17V, V <sub>GS</sub> =0V	-	-	10	μA
I <sub>GSS</sub>	Gate to source leak current	V <sub>GS</sub> =10V, V <sub>DS</sub> =0V	-	-	1	μA
V <sub>TH</sub>	Gate threshold voltage	V <sub>DS</sub> =12V, I <sub>DS</sub> =1mA	1.0	-	3.0	V
P <sub>out</sub>	Output power	f=900MHz, V <sub>DD</sub> =12.5V	45	50	-	W
η <sub>D</sub>	Drain efficiency	P <sub>in</sub> =15W, I <sub>dq</sub> =2.0A	45	50	-	%
	Load VSWR tolerance	V <sub>DD</sub> =15.2V, P <sub>o</sub> =45W(PinControl) I <sub>dq</sub> =2.0A, Z <sub>g</sub> =50Ω Load VSWR=20:1(All Phase)	No destroy			-

Note : Above parameters , ratings , limits and conditions are subject to change.



ELECTROSTATIC SENSITIVE DEVICE  
OBSERVE HANDLING PRECAUTIONS

MITSUBISHI RF POWER MOS FET

# RD45HMF1

RoHS Compliance, Silicon MOSFET Power Transistor 900MHz,45W

## TYPICAL CHARACTERISTICS

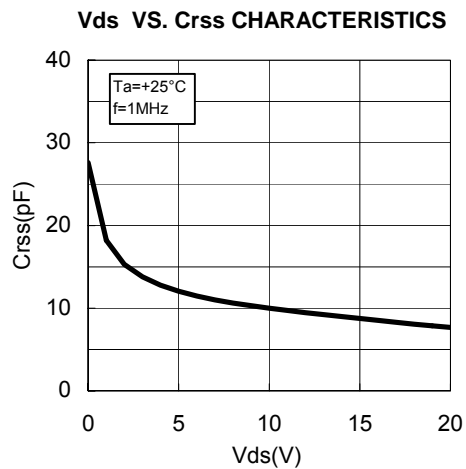
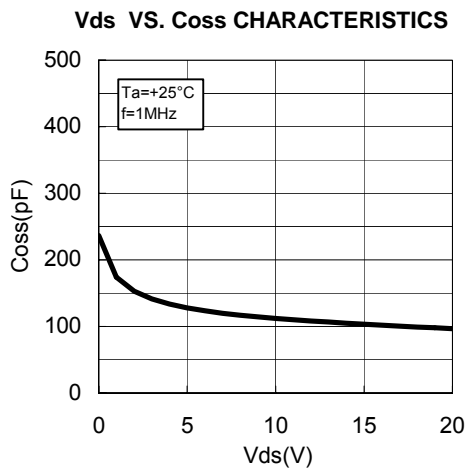
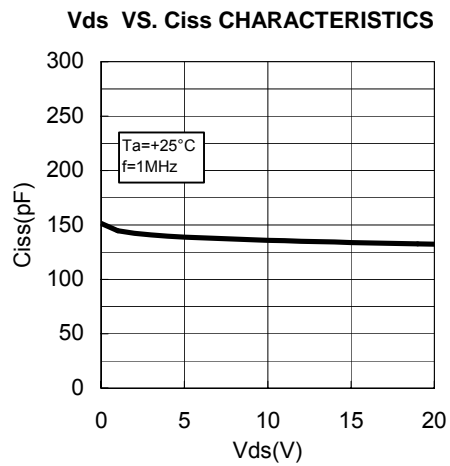
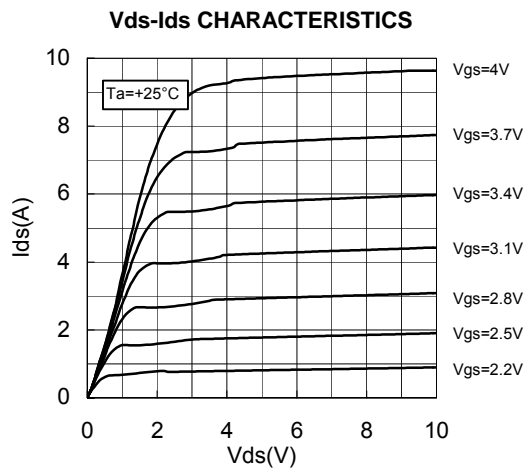
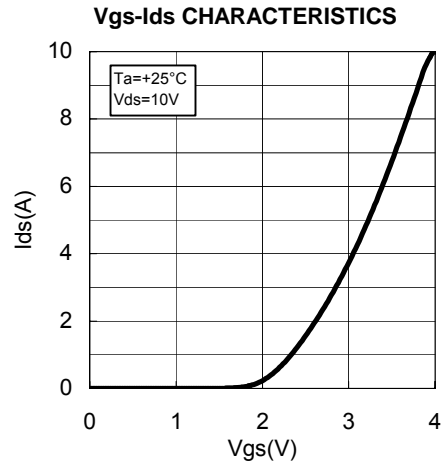
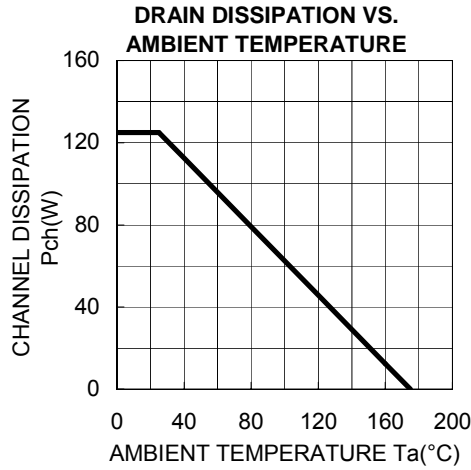



ELECTROSTATIC SENSITIVE DEVICE  
OBSERVE HANDLING PRECAUTIONS

MITSUBISHI RF POWER MOS FET

# RD45HMF1

RoHS Compliance, Silicon MOSFET Power Transistor 900MHz,45W

## TYPICAL CHARACTERISTICS

Pin-Po CHARACTERISTICS

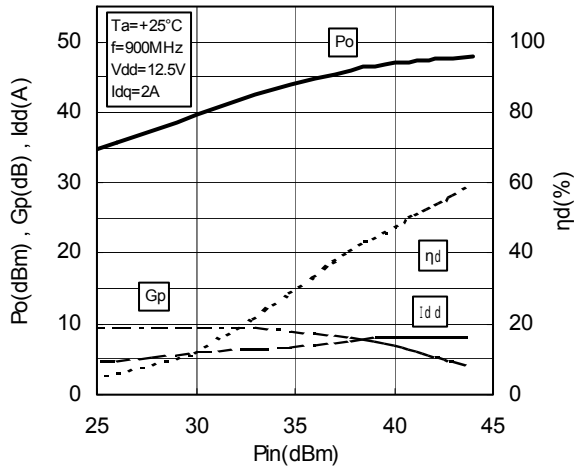

Pin-Po CHARACTERISTICS

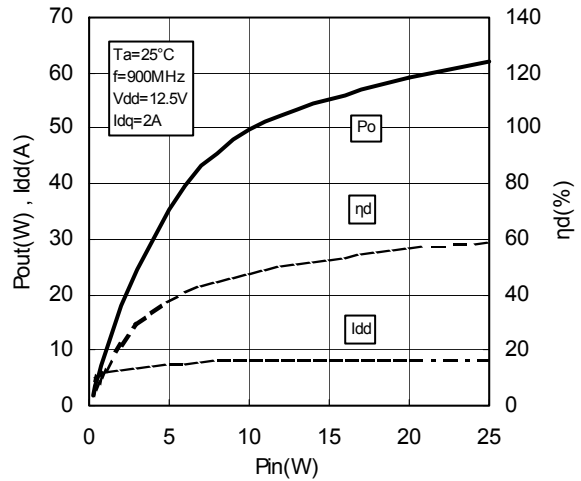

Vdd-Po CHARACTERISTICS

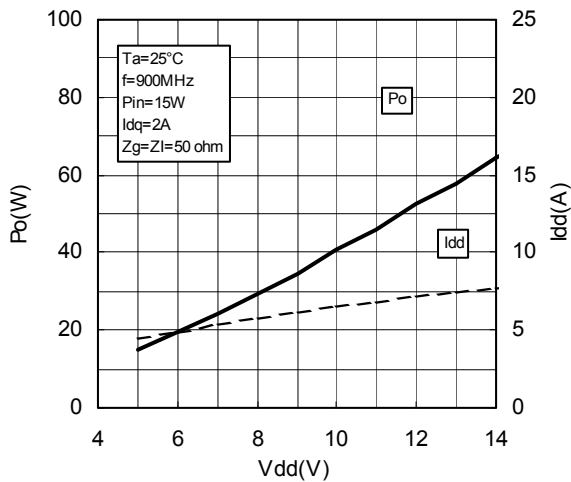

Vgs-Ids CHARACTERISTICS 2

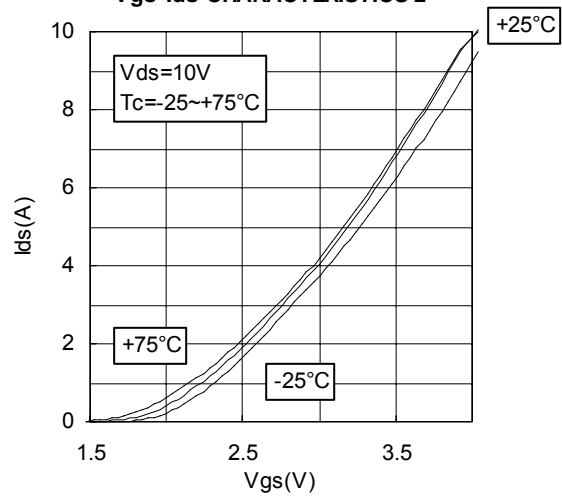

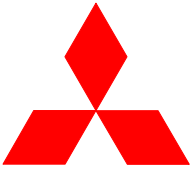

**ELECTROSTATIC SENSITIVE DEVICE**  
OBSERVE HANDLING PRECAUTIONS

**MITSUBISHI RF POWER MOS FET**

**RD45HMF1**

**RoHS Compliance, Silicon MOSFET Power Transistor 900MHz,45W**

**TEST CIRCUIT(f=900MHz)**

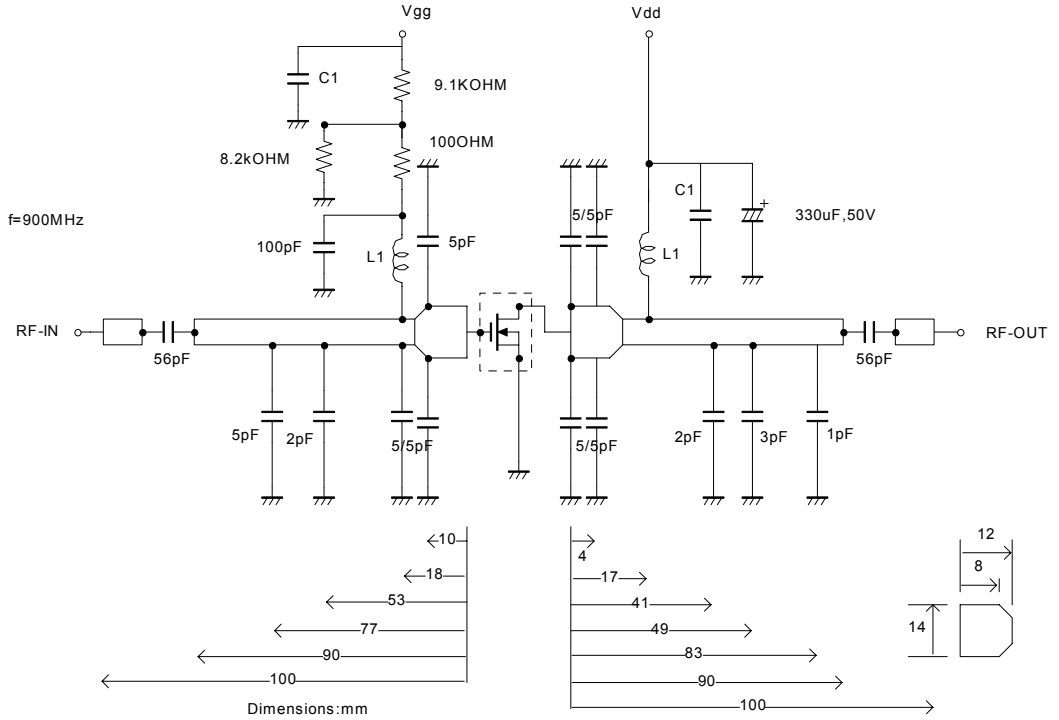

C1:2200pF\*2 in parallel

L1:1Turns,I.D3mm,D1.5mm silver plated copper wire

Note:Board material-Teflon substrate

Micro strip line width=4.2mm/50OHM,er:2.7,t=1.6mm



**ELECTROSTATIC SENSITIVE DEVICE**  
OBSERVE HANDLING PRECAUTIONS

MITSUBISHI RF POWER MOS FET

**RD45HMF1**

RoHS Compliance, Silicon MOSFET Power Transistor 900MHz,45W

**INPUT/OUTPUT IMPEDANCE VS.FREQUENCY CHARACTERISTICS**

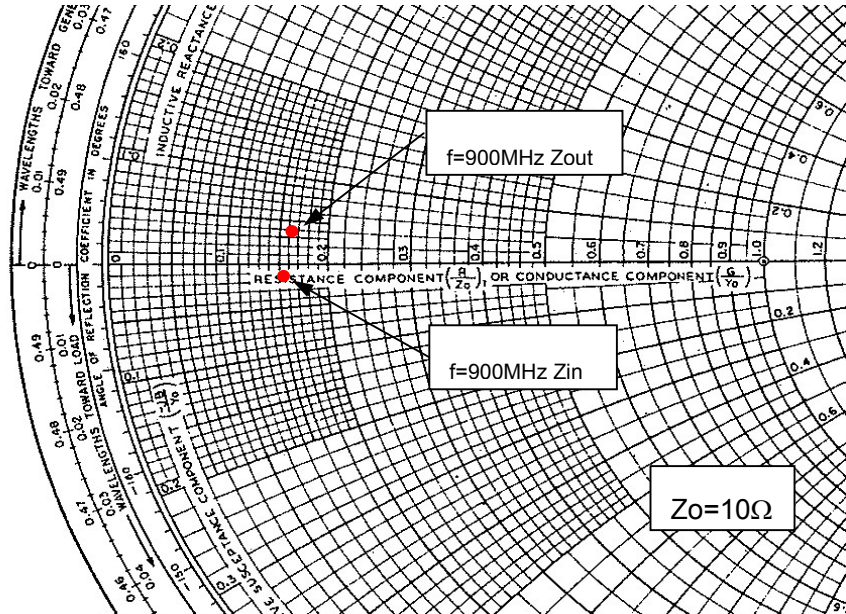

Zin , Zout

f	Zin	Zout	Conditions
(MHz)	(ohm)	(ohm)	
900	1.53-j0.17	1.63+j0.34	Po=45W, Vdd=12.5V, Pin=15W

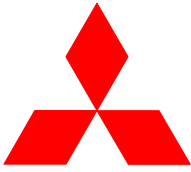

**ELECTROSTATIC SENSITIVE DEVICE**  
OBSERVE HANDLING PRECAUTIONS

MITSUBISHI RF POWER MOS FET

# RD45HMF1

**RoHS Compliance, Silicon MOSFET Power Transistor 900MHz,45W**

RD45HMF1 S-PARAMETER DATA (@Vdd=12.5V, Id=800mA)

Freq. [MHz]	S11		S21		S12		S22	
	(mag)	(ang)	(mag)	(ang)	(mag)	(ang)	(mag)	(ang)
100	0.902	-177.8	4.481	77.4	0.008	0.7	0.864	-176.6
200	0.911	-179.0	2.125	63.5	0.011	-26.0	0.877	-177.8
300	0.917	-179.6	1.319	52.3	0.011	-1.0	0.895	-179.0
400	0.932	179.9	0.889	43.0	0.007	-25.4	0.924	179.7
500	0.941	178.7	0.642	35.6	0.005	24.9	0.936	178.8
600	0.945	177.7	0.497	30.2	0.004	14.3	0.937	177.6
700	0.950	176.6	0.384	23.3	0.005	60.8	0.948	176.2
800	0.955	175.5	0.318	18.7	0.006	66.9	0.954	174.6
900	0.959	174.4	0.265	15.6	0.008	66.0	0.951	173.7
1000	0.961	173.6	0.226	11.1	0.008	33.5	0.956	172.5
1100	0.964	171.6	0.178	9.0	0.012	74.4	0.962	170.8
1200	0.963	170.3	0.166	7.6	0.009	52.8	0.961	169.6
1300	0.966	168.5	0.147	2.2	0.013	71.1	0.966	168.1
1400	0.967	167.0	0.109	0.3	0.016	70.5	0.961	166.1
1500	0.965	165.3	0.106	8.8	0.014	57.8	0.958	164.6
1600	0.969	163.0	0.102	16.2	0.022	71.3	0.968	163.2
1700	0.969	161.1	0.106	10.0	0.021	78.6	0.956	161.1
1800	0.966	158.8	0.113	4.1	0.024	65.7	0.960	159.5
1900	0.967	156.3	0.122	-3.7	0.026	64.1	0.965	156.7
2000	0.963	153.9	0.106	1.7	0.028	59.4	0.955	154.6
2100	0.963	150.9	0.101	1.7	0.031	57.5	0.958	152.0
2200	0.961	148.3	0.093	-6.4	0.031	55.0	0.961	148.9
2300	0.956	145.2	0.094	-4.9	0.037	54.6	0.953	145.6
2400	0.955	142.3	0.096	-6.1	0.038	52.0	0.949	142.9
2500	0.954	139.3	0.091	-10.5	0.041	47.9	0.958	138.9
2600	0.949	136.1	0.093	-12.6	0.044	43.8	0.943	135.4
2700	0.949	133.0	0.081	-16.4	0.045	40.7	0.946	132.3
2800	0.948	129.6	0.083	-19.7	0.046	33.2	0.948	127.9
2900	0.943	126.3	0.086	-24.1	0.048	32.8	0.937	124.3
3000	0.939	123.0	0.087	-31.6	0.061	10.7	0.934	120.9



**ELECTROSTATIC SENSITIVE DEVICE**  
OBSERVE HANDLING PRECAUTIONS

**mitsubishi** RF POWER MOS FET

**RD45HMF1**

**RoHS Compliance, Silicon MOSFET Power Transistor 900MHz,45W**

---

Keep safety first in your circuit designs!

Mitsubishi Electric Corporation puts the maximum effort into making semiconductor products better and more reliable, but there is always the possibility that trouble may occur with them. Trouble with semiconductors may lead to personal injury, fire or property damage. Remember to give due consideration to safety when making your circuit designs, with appropriate measures such as (i) placement of substitutive, auxiliary circuits, (ii) use of non-flammable material or (iii) prevention against any malfunction or mishap.