

# 2SA1774G, S2SA1774G

## PNP Silicon General Purpose Amplifier Transistor

This PNP transistor is designed for general purpose amplifier applications. This device is housed in the SC-75/SOT-416/SC-90 package which is designed for low power surface mount applications, where board space is at a premium.

### Features

- Reduces Board Space
- High  $h_{FE}$ , 210–460 (typical)
- Low  $V_{CE(sat)}$ , < 0.5 V
- Available in 8 mm, 7-inch/3000 Unit Tape and Reel
- S Prefix for Automotive and Other Applications Requiring Unique Site and Control Change Requirements; AEC-Q101 Qualified and PPAP Capable
- These Devices are Pb-Free, Halogen Free/BFR Free and are RoHS Compliant\*

### MAXIMUM RATINGS ( $T_A = 25^\circ\text{C}$ )

Rating	Symbol	Value	Unit
Collector – Emitter Voltage	$V_{(BR)CBO}$	-60	Vdc
Collector – Base Voltage	$V_{(BR)CEO}$	-50	Vdc
Emitter – Base Voltage	$V_{(BR)EBO}$	-6.0	Vdc
Collector Current – Continuous	$I_C$	-100	mAdc

### THERMAL CHARACTERISTICS

Characteristic	Symbol	Max	Unit
Power Dissipation (Note 1)	$P_D$	150	mW
Junction Temperature	$T_J$	150	$^\circ\text{C}$
Storage Temperature Range	$T_{stg}$	-55 ~ +150	$^\circ\text{C}$

Stresses exceeding Maximum Ratings may damage the device. Maximum Ratings are stress ratings only. Functional operation above the Recommended Operating Conditions is not implied. Extended exposure to stresses above the Recommended Operating Conditions may affect device reliability.

1. Device mounted on a FR-4 glass epoxy printed circuit board using the minimum recommended footprint.

\*For additional information on our Pb-Free strategy and soldering details, please download the ON Semiconductor Soldering and Mounting Techniques Reference Manual, SOLDERRM/D.



ON Semiconductor®

<http://onsemi.com>



SC-75  
CASE 463  
STYLE 1

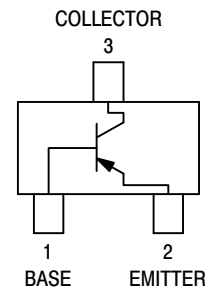

### MARKING DIAGRAM

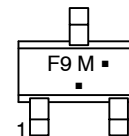

F9 = Device Code  
M = Date Code\*  
▪ = Pb-Free Package

(Note: Microdot may be in either location)

\*Date Code orientation may vary depending upon manufacturing location.

### ORDERING INFORMATION

Device	Package	Shipping†
2SA1774G	SC-75 (Pb-Free)	3,000/Tape & Reel
S2SA1774G	SC-75 (Pb-Free)	3,000/Tape & Reel
2SA1774T1G	SC-75 (Pb-Free)	3,000/Tape & Reel

†For information on tape and reel specifications, including part orientation and tape sizes, please refer to our Tape and Reel Packaging Specifications Brochure, BRD8011/D.

## 2SA1774G, S2SA1774G

### ELECTRICAL CHARACTERISTICS ( $T_A = 25^\circ\text{C}$ )

Characteristic	Symbol	Min	Typ	Max	Unit
Collector-Base Breakdown Voltage ( $I_C = -50 \mu\text{Adc}$ , $I_E = 0$ )	$V_{(BR)CBO}$	-60	-	-	Vdc
Collector-Emitter Breakdown Voltage ( $I_C = -1.0 \text{mAdc}$ , $I_B = 0$ )	$V_{(BR)CEO}$	-50	-	-	Vdc
Emitter-Base Breakdown Voltage ( $I_E = -50 \mu\text{Adc}$ , $I_C = 0$ )	$V_{(BR)EBO}$	-6.0	-	-	Vdc
Collector-Base Cutoff Current ( $V_{CB} = -30 \text{Vdc}$ , $I_E = 0$ )	$I_{CBO}$	-	-	-0.5	nA
Emitter-Base Cutoff Current ( $V_{EB} = -5.0 \text{Vdc}$ , $I_B = 0$ )	$I_{EBO}$	-	-	-0.5	$\mu\text{A}$
Collector-Emitter Saturation Voltage (Note 2) ( $I_C = -50 \text{mAdc}$ , $I_B = -5.0 \text{mAdc}$ )	$V_{CE(sat)}$	-	-	-0.5	Vdc
DC Current Gain (Note 2) ( $V_{CE} = -6.0 \text{Vdc}$ , $I_C = -1.0 \text{mAdc}$ )	$h_{FE}$	120	-	560	-
Transition Frequency ( $V_{CE} = -12 \text{Vdc}$ , $I_C = -2.0 \text{mAdc}$ , $f = 30 \text{MHz}$ )	$f_T$	-	140	-	MHz
Output Capacitance ( $V_{CB} = -12 \text{Vdc}$ , $I_E = 0 \text{Adc}$ , $f = 1 \text{MHz}$ )	$C_{OB}$	-	3.5	-	pF

2. Pulse Test: Pulse Width  $\leq 300 \mu\text{s}$ , D.C.  $\leq 2\%$ .

TYPICAL ELECTRICAL CHARACTERISTICS

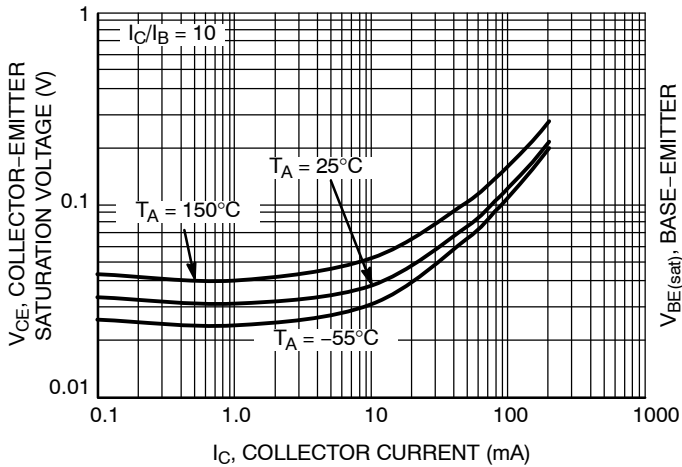

Figure 1. Collector-Emitter Saturation Voltage vs. Collector Current

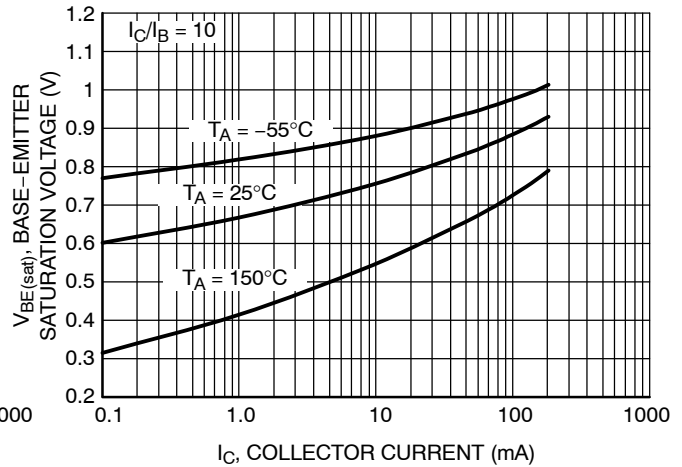

Figure 2. Base-Emitter Saturation Voltage vs. Collector Current

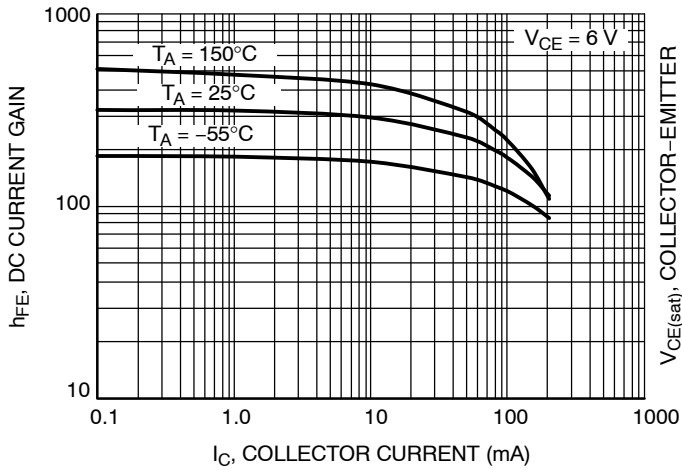

Figure 3. DC Current Gain vs. Collector Current

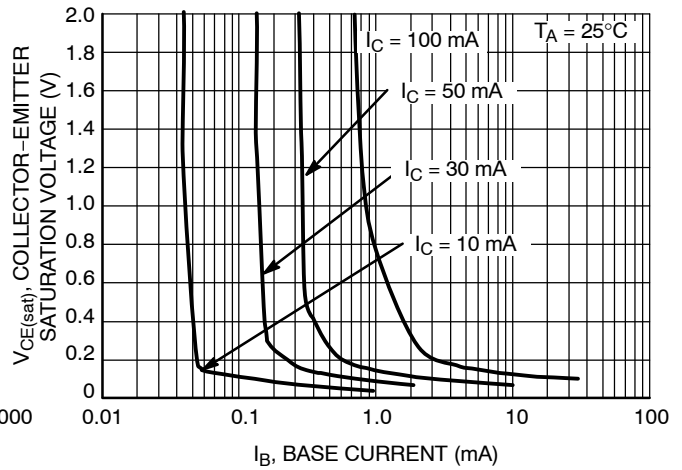

Figure 4. Saturation Region

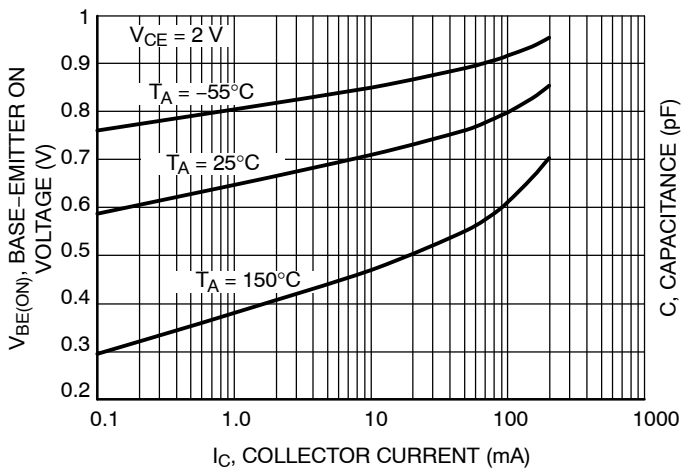

Figure 5. Base-Emitter Turn-ON Voltage vs. Collector Current

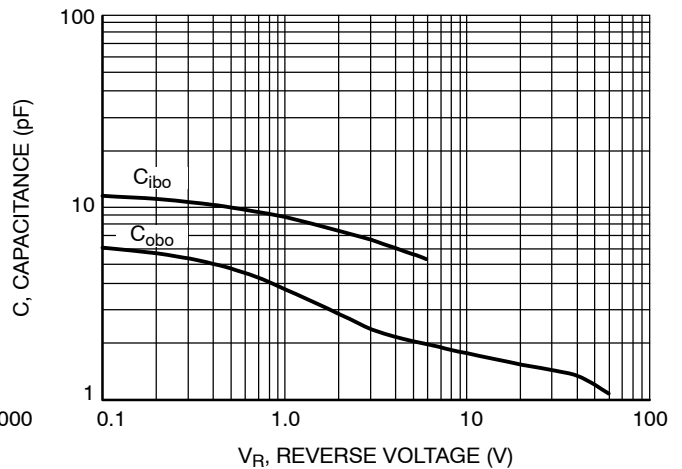

Figure 6. Capacitance

# 2SA1774G, S2SA1774G

## TYPICAL ELECTRICAL CHARACTERISTICS

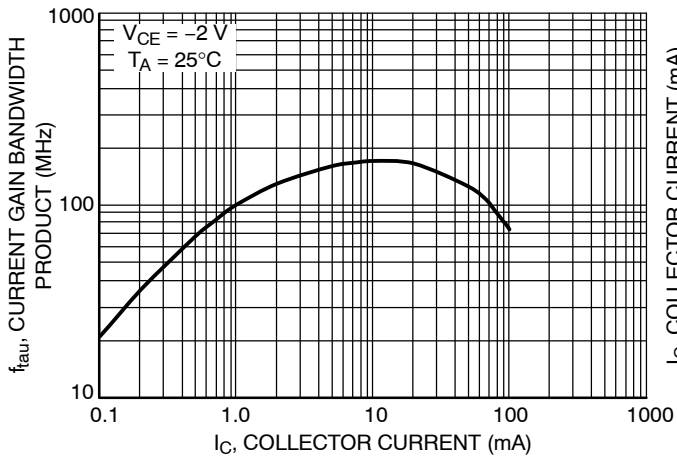

Figure 7. Current Gain Bandwidth Product vs. Collector Current

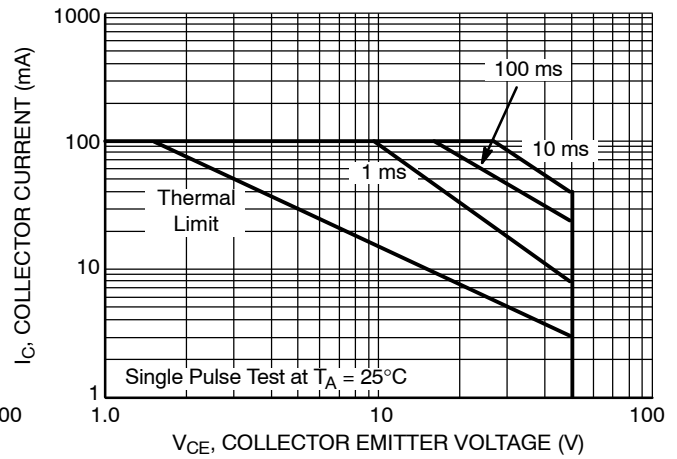
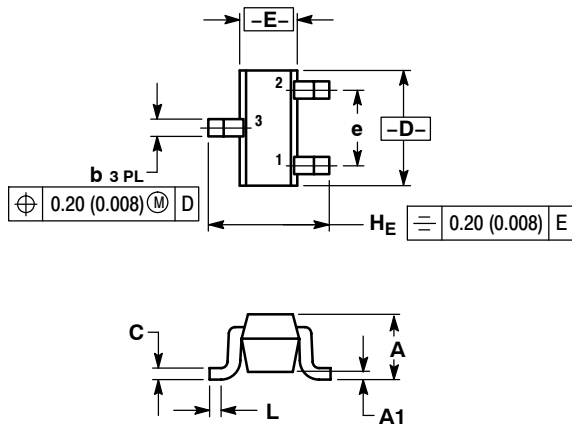

Figure 8. Safe Operating Area

# 2SA1774G, S2SA1774G

## PACKAGE DIMENSIONS

SC-75/SOT-416  
CASE 463  
ISSUE F



NOTES:

1. DIMENSIONING AND TOLERANCING PER ANSI Y14.5M, 1982.
2. CONTROLLING DIMENSION: MILLIMETER.

DIM	MILLIMETERS			INCHES		
	MIN	NOM	MAX	MIN	NOM	MAX
A	0.70	0.80	0.90	0.027	0.031	0.035
A1	0.00	0.05	0.10	0.000	0.002	0.004
b	0.15	0.20	0.30	0.006	0.008	0.012
C	0.10	0.15	0.25	0.004	0.006	0.010
D	1.55	1.60	1.65	0.059	0.063	0.067
E	0.70	0.80	0.90	0.027	0.031	0.035
e	1.00 BSC			0.04 BSC		
L	0.10	0.15	0.20	0.004	0.006	0.008
H <sub>E</sub>	1.50	1.60	1.70	0.061	0.063	0.065

STYLE 1:

- PIN 1. BASE
- EMITTER
- COLLECTOR

### SOLDERING FOOTPRINT\*

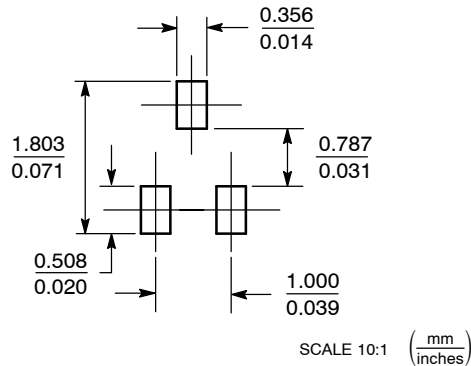

SCALE 10:1 ( $\frac{\text{mm}}{\text{inches}}$ )

\*For additional information on our Pb-Free strategy and soldering details, please download the ON Semiconductor Soldering and Mounting Techniques Reference Manual, SOLDERRM/D.

ON Semiconductor and are registered trademarks of Semiconductor Components Industries, LLC (SCILLC). SCILLC reserves the right to make changes without further notice to any products herein. SCILLC makes no warranty, representation or guarantee regarding the suitability of its products for any particular purpose, nor does SCILLC assume any liability arising out of the application or use of any product or circuit, and specifically disclaims any and all liability, including without limitation special, consequential or incidental damages. "Typical" parameters which may be provided in SCILLC data sheets and/or specifications can and do vary in different applications and actual performance may vary over time. All operating parameters, including "Typicals" must be validated for each customer application by customer's technical experts. SCILLC does not convey any license under its patent rights nor the rights of others. SCILLC products are not designed, intended, or authorized for use as components in systems intended for surgical implant into the body, or other applications intended to support or sustain life, or for any other application in which the failure of the SCILLC product could create a situation where personal injury or death may occur. Should Buyer purchase or use SCILLC products for any such unintended or unauthorized application, Buyer shall indemnify and hold SCILLC and its officers, employees, subsidiaries, affiliates, and distributors harmless against all claims, costs, damages, and expenses, and reasonable attorney fees arising out of, directly or indirectly, any claim of personal injury or death associated with such unintended or unauthorized use, even if such claim alleges that SCILLC was negligent regarding the design or manufacture of the part. SCILLC is an Equal Opportunity/Affirmative Action Employer. This literature is subject to all applicable copyright laws and is not for resale in any manner.

### PUBLICATION ORDERING INFORMATION

LITERATURE FULFILLMENT:  
Literature Distribution Center for ON Semiconductor  
P.O. Box 5163, Denver, Colorado 80217 USA  
Phone: 303-675-2175 or 800-344-3860 Toll Free USA/Canada  
Fax: 303-675-2176 or 800-344-3867 Toll Free USA/Canada  
Email: orderlit@onsemi.com

N. American Technical Support: 800-282-9855 Toll Free  
USA/Canada  
Europe, Middle East and Africa Technical Support:  
Phone: 421 33 790 2910  
Japan Customer Focus Center  
Phone: 81-3-5817-1050

ON Semiconductor Website: [www.onsemi.com](http://www.onsemi.com)  
Order Literature: <http://www.onsemi.com/orderlit>

For additional information, please contact your local Sales Representative

[www.BDTIC.com/ON/](http://www.BDTIC.com/ON/)

2SA1774/D