



SANYO Semiconductors

DATA SHEET

An ON Semiconductor Company

2SC5646A — NPN Epitaxial Planar Silicon Transistor UHF to S-Band Low-Noise Amplifier, OSC Applications

Features

- Low-noise : NF=1.5dB typ (f=2GHz)
- High cut-off frequency : $f_T=10\text{GHz}$ typ ($V_{CE}=1\text{V}$)
: $f_T=12.5\text{GHz}$ typ ($V_{CE}=3\text{V}$)
- Low-voltage operation
- High gain : $|S_{21e}|^2=9.5\text{dB}$ typ (f=2GHz)
- Ultrasmall, slim flat-lead package (1.4mm×0.8mm×0.6mm)
- Halogen free compliance

Specifications

Absolute Maximum Ratings at $T_a=25^\circ\text{C}$

Parameter	Symbol	Conditions	Ratings	Unit
Collector-to-Base Voltage	V_{CBO}		9	V
Collector-to-Emitter Voltage	V_{CEO}		4	V
Emitter-to-Base Voltage	V_{EBO}		2	V
Collector Current	I_C		30	mA
Collector Dissipation	P_C		100	mW
Junction Temperature	T_j		150	$^\circ\text{C}$
Storage Temperature	T_{stg}		-55 to +150	$^\circ\text{C}$

Package Dimensions

unit : mm (typ)

7029A-002

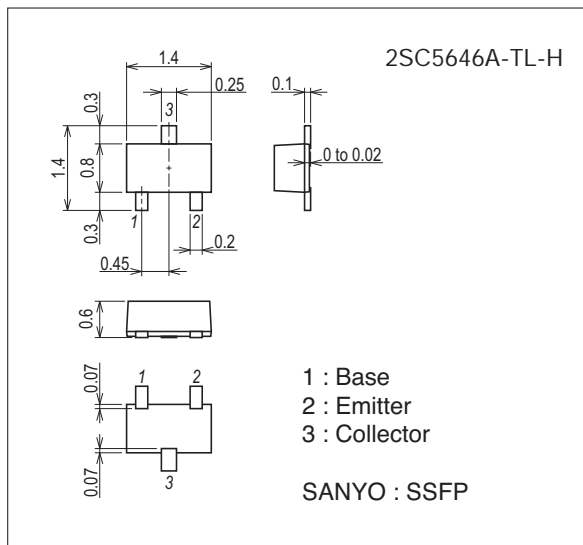

Product & Package Information

- Package : SSFP
- JEITA, JEDEC : SC-81
- Minimum Packing Quantity : 8,000 pcs./reel

Packing Type: TL

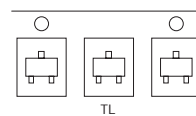

Marking

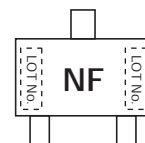

Electrical Connection

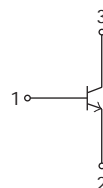

2SC5646A

Electrical Characteristics at Ta=25°C

Parameter	Symbol	Conditions	Ratings			Unit
			min	typ	max	
Collector Cutoff Current	I_{CBO}	$V_{CB}=5V, I_E=0A$			1.0	μA
Emitter Cutoff Current	I_{EBO}	$V_{EB}=1V, I_C=0A$			10	μA
DC Current Gain	h_{FE}	$V_{CE}=1V, I_C=5mA$	100		160	
Gain-Bandwidth Product	f_T1	$V_{CE}=1V, I_C=5mA$	8	10		GHz
	f_T2	$V_{CE}=3V, I_C=15mA$		12.5		GHz
Output Capacitance	C_{ob}	$V_{CB}=1V, f=1MHz$		0.55	0.7	pF
Reverse Transfer Capacitance	C_{re}			0.4		pF
Forward Transfer Gain	$ S_{21e} ^2_1$	$V_{CE}=1V, I_C=5mA, f=2GHz$	8	9.5		dB
	$ S_{21e} ^2_2$	$V_{CE}=3V, I_C=15mA, f=2GHz$		10.5		dB
Noise Figure	NF	$V_{CE}=1V, I_C=3mA, f=2GHz$		1.5	2.3	dB

Ordering Information

Device	Package	Shipping	memo
2SC5646A-TL-H	SSFP	8,000pcs./reel	Pb Free and Halogen Free

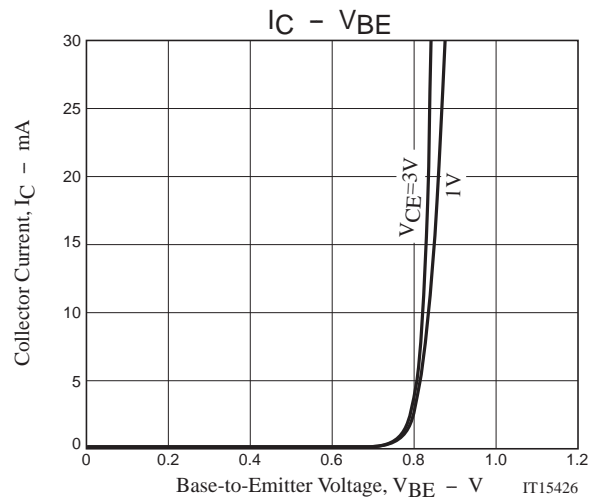
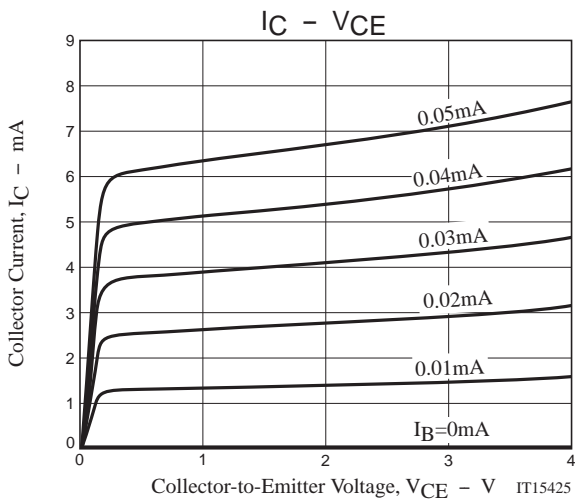

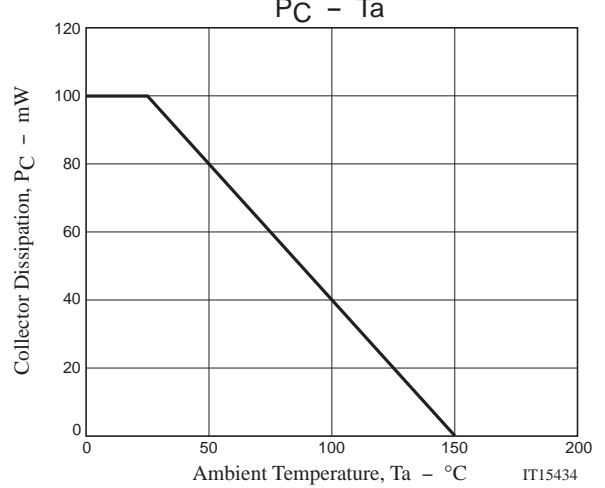
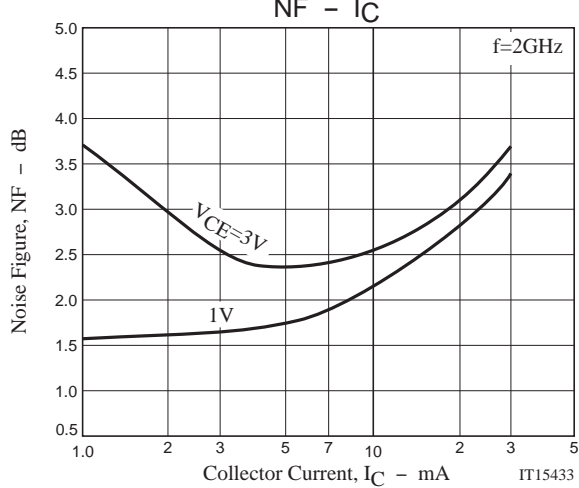
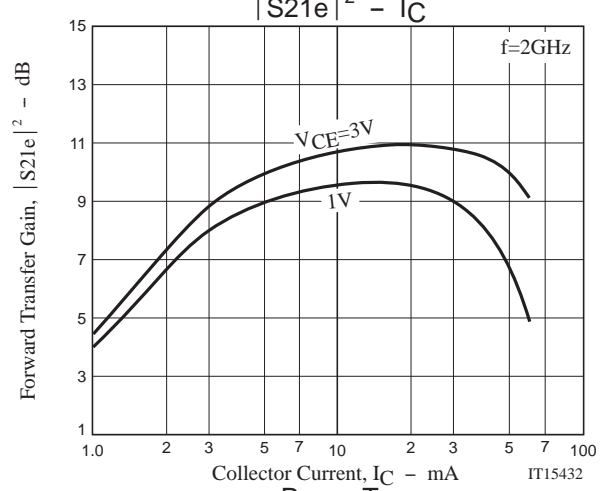
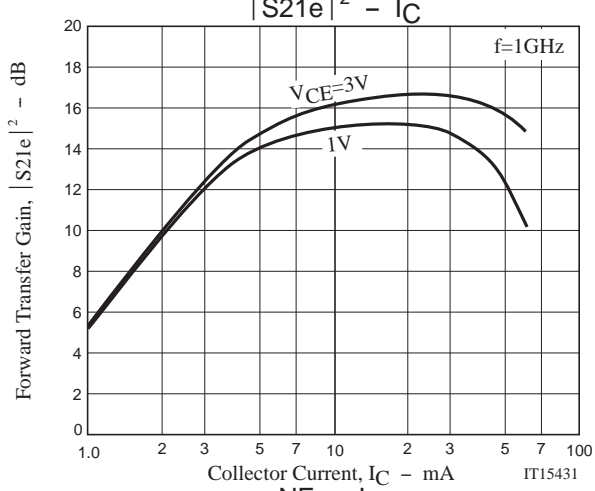
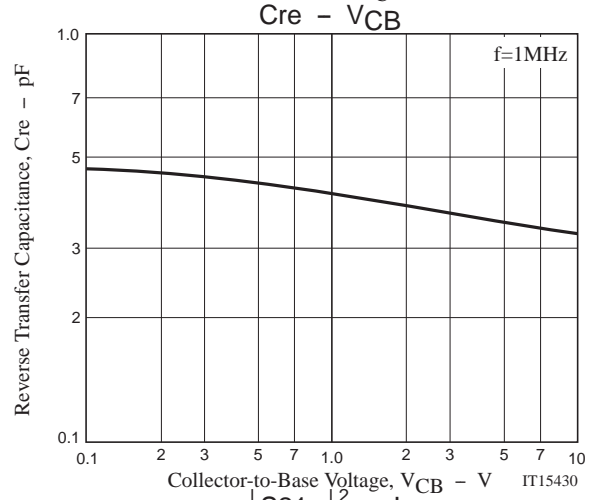
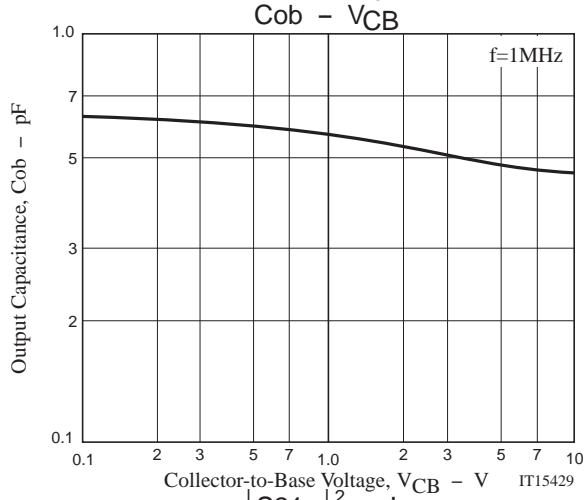
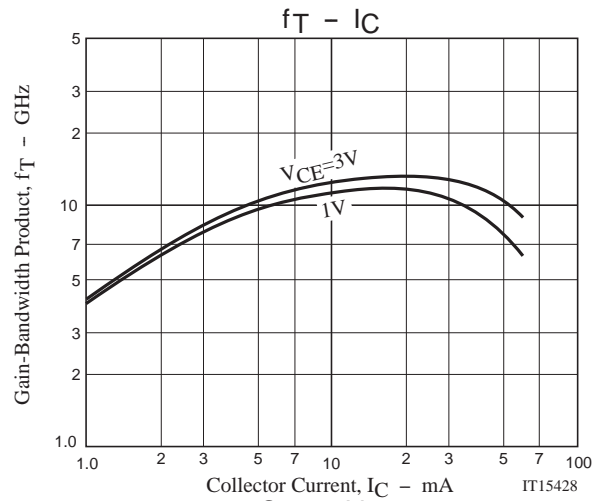
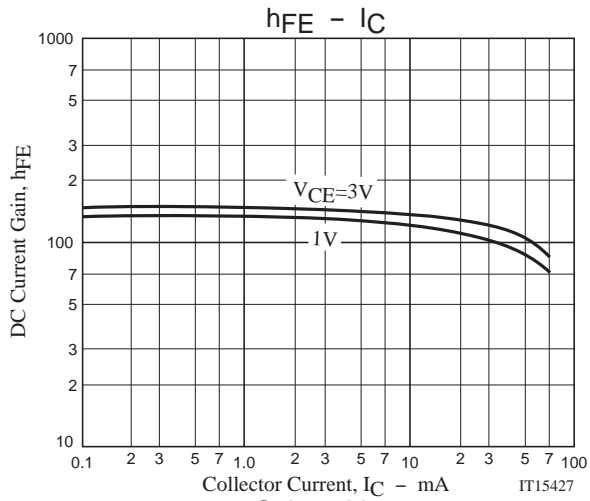

2SC5646A

S Parameters (Common emitter)

$V_{CE}=1V, I_C=1mA, Z_O=50\Omega$

Freq(MHz)	S11	$\angle S11$	S21	$\angle S21$	S12	$\angle S12$	S22	$\angle S22$
200	0.967	-13.5	2.360	164.5	0.050	74.0	0.982	-11.4
400	0.929	-26.2	2.289	150.8	0.093	67.5	0.933	-21.8
600	0.888	-36.3	1.944	138.2	0.128	58.3	0.878	-31.2
800	0.821	-51.9	2.239	128.0	0.156	50.6	0.819	-38.6
1000	0.773	-61.9	2.046	119.0	0.172	44.5	0.763	-45.2
1200	0.724	-72.5	1.952	110.3	0.190	39.5	0.717	-50.9
1400	0.662	-84.6	1.956	101.8	0.198	35.4	0.675	-56.1
1600	0.629	-91.8	1.777	95.0	0.204	31.7	0.642	-60.9
1800	0.589	-101.5	1.720	88.5	0.206	29.3	0.612	-65.0
2000	0.554	-110.4	1.649	82.4	0.208	27.2	0.589	-69.1
2200	0.537	-116.0	1.521	76.7	0.207	25.9	0.569	-73.0
2400	0.510	-124.3	1.473	71.7	0.207	24.8	0.555	-76.4
2600	0.496	-130.1	1.393	67.1	0.203	24.4	0.543	-80.2
2800	0.481	-136.1	1.328	62.6	0.201	24.2	0.533	-83.4
3000	0.468	-142.2	1.280	58.5	0.199	25.1	0.527	-86.8

$V_{CE}=1V, I_C=5mA, Z_O=50\Omega$

Freq(MHz)	S11	$\angle S11$	S21	$\angle S21$	S12	$\angle S12$	S22	$\angle S22$
200	0.826	-30.9	9.413	151.9	0.039	70.9	0.866	-27.2
400	0.679	-61.6	8.593	130.9	0.068	56.4	0.681	-44.5
600	0.576	-83.1	7.017	117.1	0.082	49.2	0.547	-55.2
800	0.485	-105.2	6.080	105.2	0.091	47.6	0.457	-61.3
1000	0.436	-120.0	5.151	97.1	0.098	48.0	0.398	-66.0
1200	0.408	-131.3	4.423	90.8	0.109	48.1	0.362	-69.5
1400	0.388	-140.8	3.896	85.3	0.115	49.4	0.331	-72.8
1600	0.376	-148.8	3.465	80.6	0.125	50.8	0.311	-76.1
1800	0.368	-155.4	3.122	76.4	0.132	51.6	0.297	-78.6
2000	0.363	-161.1	2.846	72.6	0.141	52.5	0.289	-81.8
2200	0.361	-166.5	2.621	68.8	0.150	53.6	0.280	-84.6
2400	0.358	-171.3	2.426	65.4	0.160	54.1	0.276	-87.5
2600	0.358	-175.7	2.262	62.1	0.171	54.7	0.273	-90.5
2800	0.357	-179.9	2.125	58.9	0.181	54.9	0.271	-93.3
3000	0.356	176.4	2.003	56.1	0.190	55.7	0.271	-96.4

$V_{CE}=1V, I_C=10mA, Z_O=50\Omega$

Freq(MHz)	S11	$\angle S11$	S21	$\angle S21$	S12	$\angle S12$	S22	$\angle S22$
200	0.680	-49.0	14.963	141.8	0.037	61.7	0.745	-37.5
400	0.504	-91.9	11.934	117.7	0.051	54.2	0.514	-55.1
600	0.426	-116.8	8.944	104.8	0.064	52.9	0.393	-63.2
800	0.389	-133.6	7.032	96.3	0.073	55.8	0.324	-68.3
1000	0.371	-145.4	5.768	90.2	0.083	57.7	0.282	-71.5
1200	0.362	-154.0	4.888	85.2	0.094	59.1	0.255	-74.0
1400	0.356	-161.3	4.240	80.8	0.105	60.4	0.239	-77.0
1600	0.352	-166.8	3.750	76.8	0.116	60.2	0.226	-79.4
1800	0.354	-172.1	3.363	73.2	0.128	61.2	0.221	-82.9
2000	0.353	-176.4	3.059	69.8	0.139	62.3	0.215	-86.1
2200	0.353	179.5	2.804	66.5	0.151	61.9	0.211	-88.9
2400	0.354	175.8	2.592	63.4	0.163	62.0	0.210	-91.8
2600	0.357	172.4	2.417	60.5	0.176	62.0	0.210	-95.3
2800	0.357	169.1	2.263	57.5	0.187	62.0	0.212	-98.4
3000	0.357	166.1	2.133	54.8	0.200	61.4	0.215	-101.4

2SC5646A

S Parameters (Common emitter)

$V_{CE}=1V, I_C=20mA, Z_O=50\Omega$

Freq(MHz)	S11	$\angle S11$	S21	$\angle S21$	S12	$\angle S12$	S22	$\angle S22$
200	0.492	-82.8	19.544	128.7	0.030	59.2	0.601	-47.3
400	0.399	-124.0	13.186	107.6	0.042	57.9	0.381	-61.9
600	0.377	-143.8	9.339	97.6	0.052	61.4	0.284	-68.1
800	0.367	-155.4	7.181	91.0	0.065	64.4	0.235	-71.6
1000	0.364	-163.4	5.837	85.9	0.077	66.8	0.209	-74.0
1200	0.363	-169.7	4.913	81.5	0.089	66.5	0.192	-76.9
1400	0.363	-174.8	4.250	77.7	0.102	67.0	0.182	-79.9
1600	0.364	-178.8	3.751	74.1	0.114	67.7	0.178	-82.7
1800	0.365	177.3	3.361	70.8	0.128	67.4	0.174	-85.9
2000	0.367	173.9	3.049	67.6	0.142	67.5	0.173	-89.1
2200	0.369	170.8	2.798	64.5	0.154	67.0	0.174	-93.0
2400	0.372	167.9	2.584	61.5	0.166	66.4	0.175	-95.8
2600	0.373	165.1	2.403	58.6	0.178	66.0	0.178	-98.7
2800	0.375	162.3	2.254	55.9	0.194	65.3	0.180	-102.0
3000	0.378	159.8	2.119	53.2	0.207	64.8	0.185	-104.8

$V_{CE}=3V, I_C=1mA, Z_O=50\Omega$

Freq(MHz)	S11	$\angle S11$	S21	$\angle S21$	S12	$\angle S12$	S22	$\angle S22$
200	0.969	-12.0	2.363	165.7	0.043	77.2	0.981	-9.8
400	0.942	-23.4	2.289	153.2	0.076	71.1	0.950	-18.6
600	0.906	-32.6	1.955	141.5	0.107	62.0	0.903	-27.0
800	0.847	-46.8	2.285	131.9	0.131	54.9	0.853	-33.7
1000	0.804	-55.8	2.076	123.6	0.149	48.8	0.803	-39.9
1200	0.755	-65.9	2.018	115.0	0.163	44.0	0.761	-45.1
1400	0.694	-77.3	2.042	106.9	0.173	40.0	0.721	-49.8
1600	0.662	-84.0	1.857	100.1	0.179	35.6	0.691	-54.3
1800	0.618	-93.6	1.822	93.6	0.182	33.6	0.660	-58.2
2000	0.579	-102.1	1.755	87.5	0.183	31.4	0.637	-62.0
2200	0.560	-107.6	1.616	81.9	0.183	30.1	0.616	-65.6
2400	0.529	-116.0	1.582	76.7	0.182	29.1	0.600	-68.9
2600	0.510	-121.7	1.492	72.0	0.181	28.7	0.588	-72.4
2800	0.493	-127.9	1.428	67.5	0.180	29.6	0.577	-75.5
3000	0.475	-134.3	1.381	63.3	0.177	29.8	0.569	-78.8

$V_{CE}=3V, I_C=5mA, Z_O=50\Omega$

Freq(MHz)	S11	$\angle S11$	S21	$\angle S21$	S12	$\angle S12$	S22	$\angle S22$
200	0.849	-26.5	9.604	154.4	0.034	68.7	0.895	-22.2
400	0.716	-52.4	8.894	134.9	0.056	59.5	0.736	-37.2
600	0.615	-71.2	7.356	121.6	0.072	52.4	0.605	-46.2
800	0.503	-92.9	6.628	109.2	0.081	50.8	0.519	-51.4
1000	0.441	-107.5	5.685	100.8	0.088	50.2	0.460	-54.9
1200	0.402	-118.7	4.918	94.3	0.098	51.3	0.419	-57.5
1400	0.373	-129.0	4.350	88.6	0.104	52.5	0.390	-60.0
1600	0.355	-137.2	3.872	83.8	0.112	53.4	0.369	-62.3
1800	0.343	-144.4	3.502	79.5	0.120	54.1	0.352	-64.6
2000	0.332	-151.2	3.197	75.5	0.129	55.6	0.340	-67.1
2200	0.327	-156.8	2.940	71.8	0.136	56.2	0.332	-69.5
2400	0.322	-162.0	2.724	68.4	0.146	57.1	0.326	-72.0
2600	0.320	-167.1	2.541	65.0	0.156	58.0	0.322	-74.8
2800	0.319	-171.4	2.384	61.9	0.165	58.4	0.319	-77.2
3000	0.317	-175.6	2.247	58.9	0.175	58.8	0.316	-80.1

2SC5646A

S Parameters (Common emitter)

$V_{CE}=3V, I_C=10mA, Z_O=50\Omega$

Freq(MHz)	S11	$\angle S11$	S21	$\angle S21$	S12	$\angle S12$	S22	$\angle S22$
200	0.721	-40.7	15.749	145.6	0.028	64.8	0.794	-30.5
400	0.531	-78.2	13.000	122.1	0.046	57.2	0.583	-44.9
600	0.428	-102.2	9.969	108.6	0.056	58.2	0.458	-51.3
800	0.372	-120.2	7.950	99.6	0.066	56.8	0.387	-54.3
1000	0.342	-133.0	6.549	93.0	0.077	59.1	0.344	-56.1
1200	0.325	-142.5	5.564	87.9	0.084	60.8	0.314	-57.6
1400	0.316	-150.8	4.833	83.4	0.095	61.6	0.296	-59.3
1600	0.309	-157.5	4.276	79.4	0.106	63.2	0.284	-61.2
1800	0.306	-162.9	3.835	75.8	0.117	63.7	0.275	-63.4
2000	0.304	-168.1	3.486	72.4	0.128	64.3	0.268	-65.7
2200	0.304	-172.5	3.197	69.2	0.138	64.2	0.263	-67.8
2400	0.304	-176.5	2.955	66.1	0.149	64.3	0.261	-70.8
2600	0.305	-179.5	2.753	63.1	0.161	64.6	0.260	-73.5
2800	0.308	-176.0	2.576	60.2	0.172	64.3	0.258	-76.4
3000	0.308	-172.8	2.423	57.5	0.184	64.2	0.259	-78.9

$V_{CE}=3V, I_C=20mA, Z_O=50\Omega$

Freq(MHz)	S11	$\angle S11$	S21	$\angle S21$	S12	$\angle S12$	S22	$\angle S22$
200	0.537	-63.4	22.589	134.4	0.024	61.2	0.673	-37.7
400	0.387	-106.2	15.289	111.6	0.038	58.4	0.458	-48.4
600	0.336	-128.8	10.917	100.7	0.047	62.9	0.356	-51.5
800	0.318	-143.0	8.424	93.7	0.059	65.4	0.304	-52.6
1000	0.309	-152.8	6.849	88.4	0.069	69.0	0.275	-53.4
1200	0.306	-160.1	5.773	84.0	0.081	68.8	0.258	-54.5
1400	0.305	-166.3	4.995	80.1	0.092	69.1	0.247	-56.1
1600	0.303	-171.2	4.410	76.6	0.103	70.3	0.240	-58.2
1800	0.304	-175.4	3.947	73.3	0.116	69.6	0.234	-60.1
2000	0.304	-179.2	3.576	70.1	0.128	69.2	0.233	-62.6
2200	0.308	-177.4	3.275	67.1	0.139	69.2	0.230	-65.6
2400	0.310	-174.1	3.027	64.3	0.152	69.3	0.229	-68.1
2600	0.310	-170.9	2.815	61.5	0.164	68.3	0.229	-71.1
2800	0.314	-168.1	2.639	58.7	0.176	68.2	0.231	-74.1
3000	0.315	-165.2	2.479	56.2	0.187	67.8	0.232	-76.9

Embossed Taping Specification

2SC5646A-TL-H

1. Packing Format

Package Name	Carrier Tape Type	Maximum Number of devices contained (pcs)			Packing format	
		Reel	Inner box	Outer box	Inner BOX (C-1)	Outer BOX (A-7)
SSFP	SSFP	8,000	40,000	240,000	5 reels contained Dimensions:mm (external) 183×72×185	6 inner boxes contained Dimension::mm (external) 440×195×210

Packing method

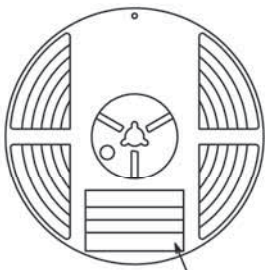

Reel label

Reel label, Inner box label
(unit:mm)

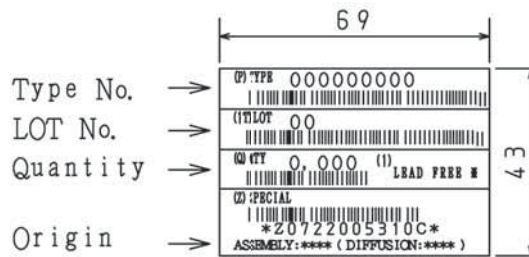

Outer box label
It is a label at the time of factory shipments.
The form of a label may change in physical distribution process.

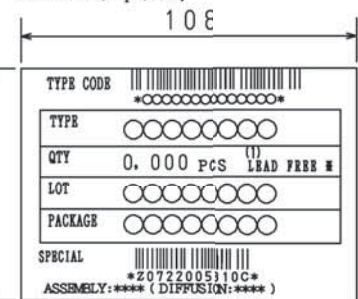

NOTE (1)

The LEAD FREE * description shows that the surface treatment of the terminal is lead free.

Label	JEITA Phase
LEAD FREE 3	JEITA Phase 3A
LEAD FREE 4	JEITA Phase 3

2. Taping configuration

2-1. Carrier tape size (unit:mm)

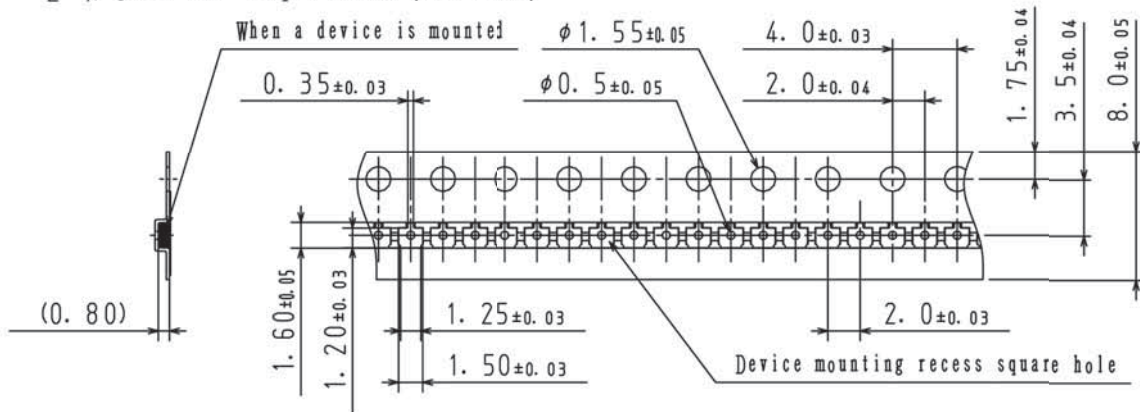

2-2. Device placement direction

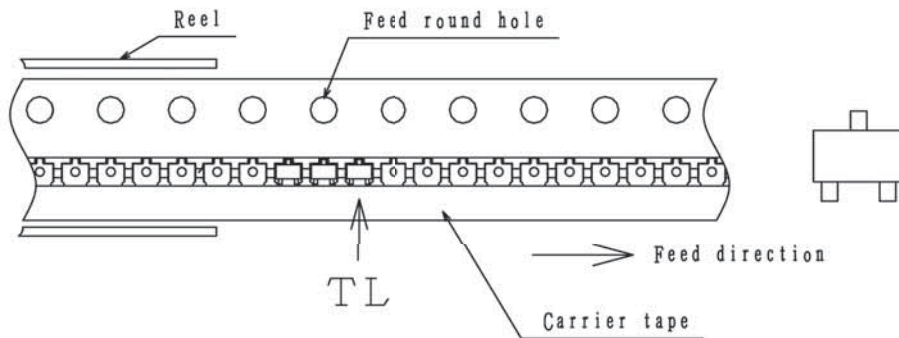

Those with pin 1 index on the feed hole side.....TL

2SC5646A

Outline Drawing

2SC5646A-TL-H

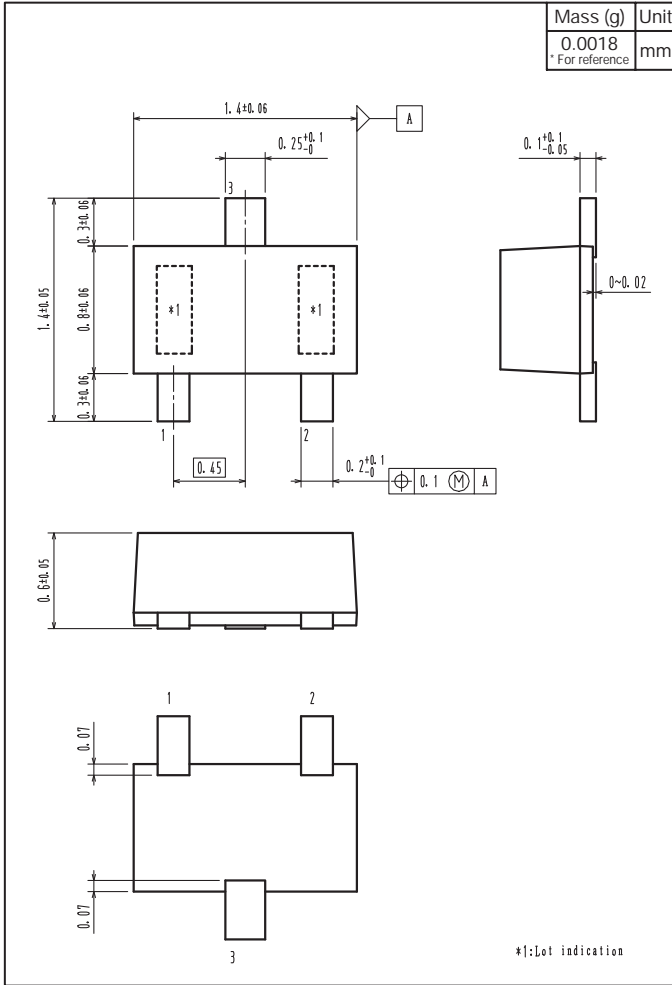

Land Pattern Example

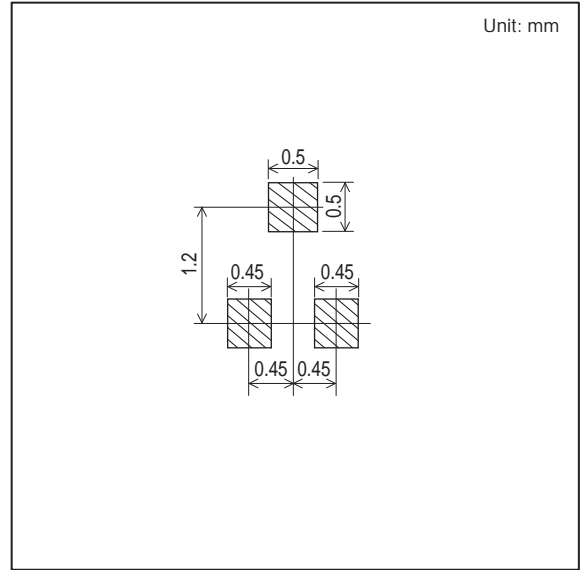

- Any and all SANYO Semiconductor Co.,Ltd. products described or contained herein are, with regard to "standard application", intended for the use as general electronics equipment. The products mentioned herein shall not be intended for use for any "special application" (medical equipment whose purpose is to sustain life, aerospace instrument, nuclear control device, burning appliances, transportation machine, traffic signal system, safety equipment etc.) that shall require extremely high level of reliability and can directly threaten human lives in case of failure or malfunction of the product or may cause harm to human bodies, nor shall they grant any guarantee thereof. If you should intend to use our products for new introduction or other application different from current conditions on the usage of automotive device, communication device, office equipment, industrial equipment etc. , please consult with us about usage condition (temperature, operation time etc.) prior to the intended use. If there is no consultation or inquiry before the intended use, our customer shall be solely responsible for the use.
- Specifications of any and all SANYO Semiconductor Co.,Ltd. products described or contained herein stipulate the performance, characteristics, and functions of the described products in the independent state, and are not guarantees of the performance, characteristics, and functions of the described products as mounted in the customer's products or equipment. To verify symptoms and states that cannot be evaluated in an independent device, the customer should always evaluate and test devices mounted in the customer's products or equipment.
- SANYO Semiconductor Co.,Ltd. assumes no responsibility for equipment failures that result from using products at values that exceed, even momentarily, rated values (such as maximum ratings, operating condition ranges, or other parameters) listed in products specifications of any and all SANYO Semiconductor Co.,Ltd. products described or contained herein.
- Regarding monolithic semiconductors, if you should intend to use this IC continuously under high temperature, high current, high voltage, or drastic temperature change, even if it is used within the range of absolute maximum ratings or operating conditions, there is a possibility of decrease reliability. Please contact us for a confirmation.
- SANYO Semiconductor Co.,Ltd. strives to supply high-quality high-reliability products, however, any and all semiconductor products fail or malfunction with some probability. It is possible that these probabilistic failures or malfunction could give rise to accidents or events that could endanger human lives, trouble that could give rise to smoke or fire, or accidents that could cause damage to other property. When designing equipment, adopt safety measures so that these kinds of accidents or events cannot occur. Such measures include but are not limited to protective circuits and error prevention circuits for safe design, redundant design, and structural design.
- In the event that any or all SANYO Semiconductor Co.,Ltd. products described or contained herein are controlled under any of applicable local export control laws and regulations, such products may require the export license from the authorities concerned in accordance with the above law.
- No part of this publication may be reproduced or transmitted in any form or by any means, electronic or mechanical, including photocopying and recording, or any information storage or retrieval system, or otherwise, without the prior written consent of SANYO Semiconductor Co.,Ltd.
- Any and all information described or contained herein are subject to change without notice due to product/technology improvement, etc. When designing equipment, refer to the "Delivery Specification" for the SANYO Semiconductor Co.,Ltd. product that you intend to use.
- Upon using the technical information or products described herein, neither warranty nor license shall be granted with regard to intellectual property rights or any other rights of SANYO Semiconductor Co.,Ltd. or any third party. SANYO Semiconductor Co.,Ltd. shall not be liable for any claim or suits with regard to a third party's intellectual property rights which has resulted from the use of the technical information and products mentioned above.

This catalog provides information as of July, 2012. Specifications and information herein are subject to change without notice.