

BAW56LT1G, SBAW56LT1G, BAW56LT3G, SBAW56LT3G



ON Semiconductor®

<http://onsemi.com>

Dual Switching Diode Common Anode

Features

- AEC-Q101 Qualified and PPAP Capable
- S Prefix for Automotive and Other Applications Requiring Unique Site and Control Change Requirements
- These Devices are Pb-Free, Halogen Free/BFR Free and are RoHS Compliant*

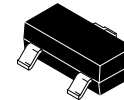

SOT-23 (TO-236)
CASE 318
STYLE 12

MAXIMUM RATINGS (EACH DIODE)

Rating	Symbol	Value	Unit
Reverse Voltage	V_R	70	V
Forward Current	I_F	200	mA
Peak Forward Surge Current	$I_{FM(surge)}$	500	mA
Non-Repetitive Peak Forward Current $t = 1 \mu s$ (Note 3)	I_{FSM}	4	A

THERMAL CHARACTERISTICS

Characteristic	Symbol	Max	Unit
Total Device Dissipation FR-5 Board (Note 1) $T_A = 25^\circ C$ Derate above $25^\circ C$	P_D	225 1.8	mW mW/ $^\circ C$
Thermal Resistance, Junction-to-Ambient	$R_{\theta JA}$	556	$^\circ C/W$
Total Device Dissipation Alumina Substrate, (Note 2) $T_A = 25^\circ C$ Derate above $25^\circ C$	P_D	300 2.4	mW mW/ $^\circ C$
Thermal Resistance, Junction-to-Ambient	$R_{\theta JA}$	417	$^\circ C/W$
Junction and Storage Temperature	T_J, T_{stg}	-55 to +150	$^\circ C$

Stresses exceeding Maximum Ratings may damage the device. Maximum Ratings are stress ratings only. Functional operation above the Recommended Operating Conditions is not implied. Extended exposure to stresses above the Recommended Operating Conditions may affect device reliability.

1. FR-5 = $1.0 \times 0.75 \times 0.062$ in.
2. Alumina = $0.4 \times 0.3 \times 0.024$ in. 99.5% alumina.
3. Square Wave; $T_J = 25^\circ C$.

*For additional information on our Pb-Free strategy and soldering details, please download the ON Semiconductor Soldering and Mounting Techniques Reference Manual, SOLDERRM/D.

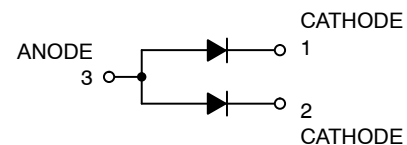

MARKING DIAGRAM

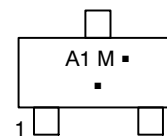

A1 = Device Code
M = Date Code*
▪ = Pb-Free Package

(Note: Microdot may be in either location)

*Date Code orientation and/or overbar may vary depending upon manufacturing location.

ORDERING INFORMATION

Device	Package	Shipping†
BAW56LT1G	SOT-23 (Pb-Free)	3,000 / Tape & Reel
SBAW56LT1G	SOT-23 (Pb-Free)	3,000 / Tape & Reel
BAW56LT3G	SOT-23 (Pb-Free)	10,000 / Tape & Reel
SBAW56LT3G	SOT-23 (Pb-Free)	10,000 / Tape & Reel

†For information on tape and reel specifications, including part orientation and tape sizes, please refer to our Tape and Reel Packaging Specifications Brochure, BRD8011/D.

BAW56LT1G, SBAW56LT1G, BAW56LT3G, SBAW56LT3G

ELECTRICAL CHARACTERISTICS ($T_A = 25^\circ\text{C}$ unless otherwise noted) (Each Diode)

Characteristic	Symbol	Min	Max	Unit
Reverse Breakdown Voltage ($I_{(BR)} = 100 \mu\text{A}$)	$V_{(BR)}$	70	-	V
Reverse Voltage Leakage Current ($V_R = 25 \text{ V}, T_J = 150^\circ\text{C}$) ($V_R = 70 \text{ V}$) ($V_R = 70 \text{ V}, T_J = 150^\circ\text{C}$)	I_R	-	30 2.5 50	μA
Diode Capacitance ($V_R = 0 \text{ V}, f = 1.0 \text{ MHz}$)	C_D	-	2.0	pF
Forward Voltage ($I_F = 1.0 \text{ mA}$) ($I_F = 10 \text{ mA}$) ($I_F = 50 \text{ mA}$) ($I_F = 150 \text{ mA}$)	V_F	-	715 855 1000 1250	mV
Reverse Recovery Time ($I_F = I_R = 10 \text{ mA}, I_{R(REC)} = 1.0 \text{ mA}$) (Figure 1) $R_L = 100 \Omega$	t_{rr}	-	6.0	ns

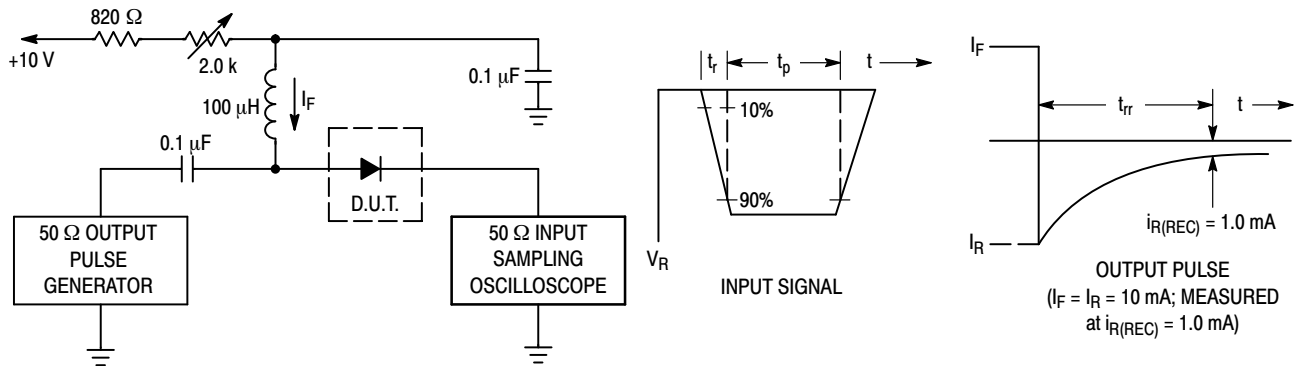

- Notes: 1. A 2.0 k Ω variable resistor adjusted for a Forward Current (I_F) of 10 mA.
 2. Input pulse is adjusted so $I_{R(\text{peak})}$ is equal to 10 mA.
 3. $t_p \gg t_{rr}$

Figure 1. Recovery Time Equivalent Test Circuit

BAW56LT1G, SBAW56LT1G, BAW56LT3G, SBAW56LT3G

Curves Applicable to Each Cathode

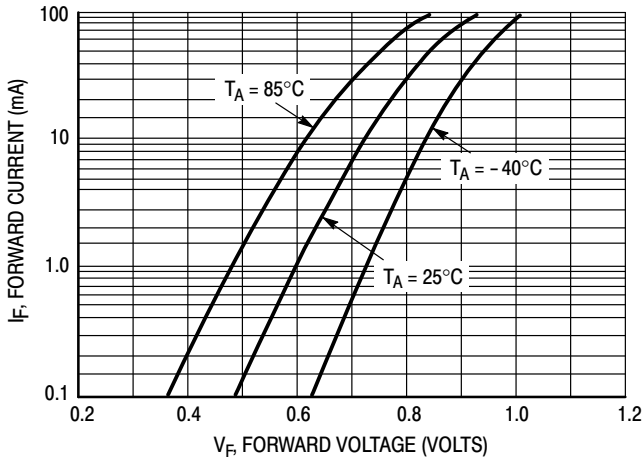

Figure 2. Forward Voltage

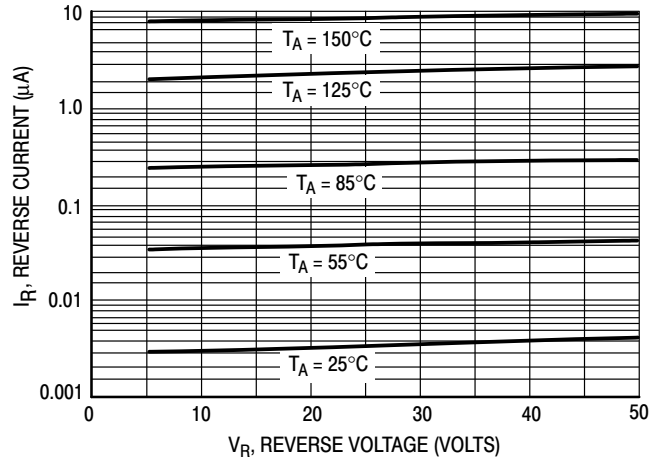

Figure 3. Leakage Current

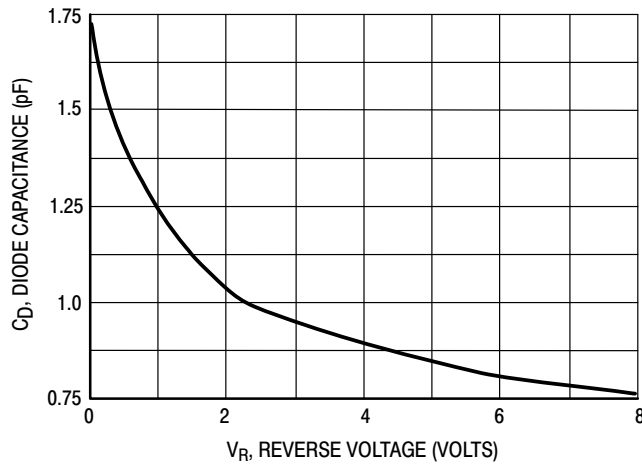
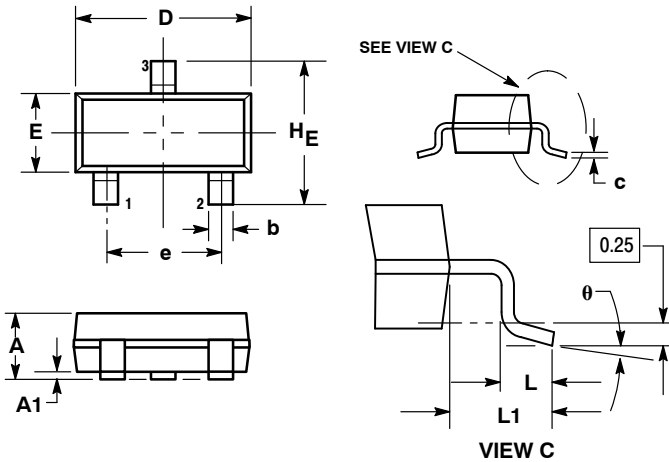

Figure 4. Capacitance

BAW56LT1G, SBAW56LT1G, BAW56LT3G, SBAW56LT3G

PACKAGE DIMENSIONS

SOT-23 (TO-236)
CASE 318-08
ISSUE AP



- NOTES:
1. DIMENSIONING AND TOLERANCING PER ANSI Y14.5M, 1982.
 2. CONTROLLING DIMENSION: INCH.
 3. MAXIMUM LEAD THICKNESS INCLUDES LEAD FINISH THICKNESS. MINIMUM LEAD THICKNESS IS THE MINIMUM THICKNESS OF BASE MATERIAL.
 4. DIMENSIONS D AND E DO NOT INCLUDE MOLD FLASH, PROTRUSIONS, OR GATE BURRS.

DIM	MILLIMETERS			INCHES		
	MIN	NOM	MAX	MIN	NOM	MAX
A	0.89	1.00	1.11	0.035	0.040	0.044
A1	0.01	0.06	0.10	0.001	0.002	0.004
b	0.37	0.44	0.50	0.015	0.018	0.020
c	0.09	0.13	0.18	0.003	0.005	0.007
D	2.80	2.90	3.04	0.110	0.114	0.120
E	1.20	1.30	1.40	0.047	0.051	0.055
e	1.78	1.90	2.04	0.070	0.075	0.081
L	0.10	0.20	0.30	0.004	0.008	0.012
L1	0.35	0.54	0.69	0.014	0.021	0.029
HE	2.10	2.40	2.64	0.083	0.094	0.104
θ	0°	---	10°	0°	---	10°

STYLE 12:
PIN 1. CATHODE
2. CATHODE
3. ANODE

SOLDERING FOOTPRINT

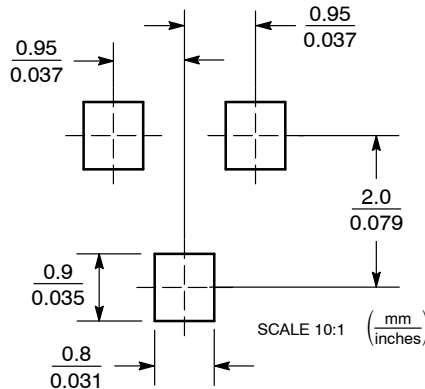

ON Semiconductor and are registered trademarks of Semiconductor Components Industries, LLC (SCILLC). SCILLC reserves the right to make changes without further notice to any products herein. SCILLC makes no warranty, representation or guarantee regarding the suitability of its products for any particular purpose, nor does SCILLC assume any liability arising out of the application or use of any product or circuit, and specifically disclaims any and all liability, including without limitation special, consequential or incidental damages. "Typical" parameters which may be provided in SCILLC data sheets and/or specifications can and do vary in different applications and actual performance may vary over time. All operating parameters, including "Typicals" must be validated for each customer application by customer's technical experts. SCILLC does not convey any license under its patent rights nor the rights of others. SCILLC products are not designed, intended, or authorized for use as components in systems intended for surgical implant into the body, or other applications intended to support or sustain life, or for any other application in which the failure of the SCILLC product could create a situation where personal injury or death may occur. Should Buyer purchase or use SCILLC products for any such unintended or unauthorized application, Buyer shall indemnify and hold SCILLC and its officers, employees, subsidiaries, affiliates, and distributors harmless against all claims, costs, damages, and expenses, and reasonable attorney fees arising out of, directly or indirectly, any claim of personal injury or death associated with such unintended or unauthorized use, even if such claim alleges that SCILLC was negligent regarding the design or manufacture of the part. SCILLC is an Equal Opportunity/Affirmative Action Employer. This literature is subject to all applicable copyright laws and is not for resale in any manner.

PUBLICATION ORDERING INFORMATION

LITERATURE FULFILLMENT:
Literature Distribution Center for ON Semiconductor
P.O. Box 5163, Denver, Colorado 80217 USA
Phone: 303-675-2175 or 800-344-3860 Toll Free USA/Canada
Fax: 303-675-2176 or 800-344-3867 Toll Free USA/Canada
Email: orderlit@onsemi.com

N. American Technical Support: 800-282-9855 Toll Free
USA/Canada
Europe, Middle East and Africa Technical Support:
Phone: 421 33 790 2910
Japan Customer Focus Center
Phone: 81-3-5817-1050

ON Semiconductor Website: www.onsemi.com
Order Literature: <http://www.onsemi.com/orderlit>
For additional information, please contact your local Sales Representative