

# BC856ALT1G Series, SBC856ALT1G Series



**ON Semiconductor®**

<http://onsemi.com>

## General Purpose Transistors

### PNP Silicon

#### Features

- AEC-Q101 Qualified and PPAP Capable
- S and NSV Prefix for Automotive and Other Applications Requiring Unique Site and Control Change Requirements
- These Devices are Pb-Free, Halogen Free/BFR Free and are RoHS Compliant

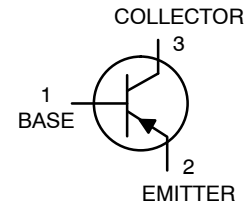

#### MAXIMUM RATINGS ( $T_A = 25^\circ\text{C}$ unless otherwise noted)

Rating	Symbol	Value	Unit
Collector-Emitter Voltage BC856, SBC856 BC857, SBC857 BC858, NSVBC858, BC859	$V_{CEO}$	-65 -45 -30	V
Collector-Base Voltage BC856, SBC856 BC857, SBC857 BC858, NSVBC858, BC859	$V_{CBO}$	-80 -50 -30	V
Emitter-Base Voltage	$V_{EBO}$	-5.0	V
Collector Current – Continuous	$I_C$	-100	mAdc

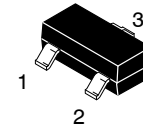

**SOT-23 (TO-236AB)  
CASE 318  
STYLE 6**

#### THERMAL CHARACTERISTICS

Characteristic	Symbol	Max	Unit
Total Device Dissipation FR-5 Board, (Note 1) $T_A = 25^\circ\text{C}$ Derate above $25^\circ\text{C}$	$P_D$	225 1.8	mW mW/ $^\circ\text{C}$
Thermal Resistance, Junction-to-Ambient	$R_{\theta JA}$	556	$^\circ\text{C}/\text{W}$
Total Device Dissipation Alumina Substrate, (Note 2) $T_A = 25^\circ\text{C}$ Derate above $25^\circ\text{C}$	$P_D$	300 2.4	mW mW/ $^\circ\text{C}$
Thermal Resistance, Junction-to-Ambient	$R_{\theta JA}$	417	$^\circ\text{C}/\text{W}$
Junction and Storage Temperature	$T_J, T_{stg}$	-55 to +150	$^\circ\text{C}$

#### MARKING DIAGRAM

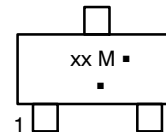

- xx = Device Code  
xx = (Refer to page 6)
- M = Date Code\*
- = Pb-Free Package

(Note: Microdot may be in either location)

\*Date Code orientation and/or overbar may vary depending upon manufacturing location.

#### ORDERING INFORMATION

See detailed ordering and shipping information in the package dimensions section on page 6 of this data sheet.

Stresses exceeding Maximum Ratings may damage the device. Maximum Ratings are stress ratings only. Functional operation above the Recommended Operating Conditions is not implied. Extended exposure to stresses above the Recommended Operating Conditions may affect device reliability.

1. FR-5 =  $1.0 \times 0.75 \times 0.062$  in.
2. Alumina =  $0.4 \times 0.3 \times 0.024$  in 99.5% alumina.

## BC856ALT1G Series, SBC856ALT1G Series

### ELECTRICAL CHARACTERISTICS ( $T_A = 25^\circ\text{C}$ unless otherwise noted)

Characteristic	Symbol	Min	Typ	Max	Unit
<b>OFF CHARACTERISTICS</b>					
Collector – Emitter Breakdown Voltage ( $I_C = -10\text{ mA}$ )	BC856, SBC856 Series BC857, SBC857 Series BC858, NSVBC858 BC859 Series	$V_{(BR)CEO}$	-65 -45 -30	- - -	V
Collector – Emitter Breakdown Voltage ( $I_C = -10\ \mu\text{A}$ , $V_{EB} = 0$ )	BC856 S, SBC856series BC857A, SBC857A, BC857B, SBC857B Only BC858, NSVB858, BC859 Series	$V_{(BR)CES}$	-80 -50 -30	- - -	V
Collector – Base Breakdown Voltage ( $I_C = -10\ \mu\text{A}$ )	BC856, SBC856 Series BC857, SBC857 Series BC858, NSVBC858, BC859 Series	$V_{(BR)CBO}$	-80 -50 -30	- - -	V
Emitter – Base Breakdown Voltage ( $I_E = -1.0\ \mu\text{A}$ )	BC856, SBC856 Series BC857, SBC857 Series BC858, NSVBC858, BC859 Series	$V_{(BR)EBO}$	-5.0 -5.0 -5.0	- - -	V
Collector Cutoff Current ( $V_{CB} = -30\text{ V}$ ) ( $V_{CB} = -30\text{ V}$ , $T_A = 150^\circ\text{C}$ )		$I_{CBO}$	- -	- -15 -4.0	nA $\mu\text{A}$
<b>ON CHARACTERISTICS</b>					
DC Current Gain ( $I_C = -10\ \mu\text{A}$ , $V_{CE} = -5.0\text{ V}$ )	BC856A, SBC856A, BC857A, SBC857A, BC858A BC856B, SBC856B, BC857B, SBC857B, BC858B, NSVBC858B BC857C, SBC857C BC858C	$h_{FE}$	- - -	90 150 270	- - -
( $I_C = -2.0\text{ mA}$ , $V_{CE} = -5.0\text{ V}$ )	BC856A, SBC856A, BC857A, SBC857A, BC858A BC856B, SBC856B, BC857B, SBC857B, BC858B, NSVBC858B, BC859B BC857C, SBC857C, BC858C, BC859C		125 220 420	180 290 520	250 475 800
Collector – Emitter Saturation Voltage ( $I_C = -10\text{ mA}$ , $I_B = -0.5\text{ mA}$ ) ( $I_C = -100\text{ mA}$ , $I_B = -5.0\text{ mA}$ )		$V_{CE(sat)}$	- -	- -	-0.3 -0.65
Base – Emitter Saturation Voltage ( $I_C = -10\text{ mA}$ , $I_B = -0.5\text{ mA}$ ) ( $I_C = -100\text{ mA}$ , $I_B = -5.0\text{ mA}$ )		$V_{BE(sat)}$	- -	-0.7 -0.9	- -
Base – Emitter On Voltage ( $I_C = -2.0\text{ mA}$ , $V_{CE} = -5.0\text{ V}$ ) ( $I_C = -10\text{ mA}$ , $V_{CE} = -5.0\text{ V}$ )		$V_{BE(on)}$	-0.6 -	- -	-0.75 -0.82
<b>SMALL-SIGNAL CHARACTERISTICS</b>					
Current – Gain – Bandwidth Product ( $I_C = -10\text{ mA}$ , $V_{CE} = -5.0\text{ Vdc}$ , $f = 100\text{ MHz}$ )		$f_T$	100	-	MHz
Output Capacitance ( $V_{CB} = -10\text{ V}$ , $f = 1.0\text{ MHz}$ )		$C_{ob}$	-	-	4.5 pF
Noise Figure ( $I_C = -0.2\text{ mA}$ , $V_{CE} = -5.0\text{ Vdc}$ , $R_S = 2.0\text{ k}\Omega$ , $f = 1.0\text{ kHz}$ , $BW = 200\text{ Hz}$ ) BC856, SBC856, BC857, SBC857, BC858, NSVBC858 Series BC859 Series		NF	- -	- -	10 4.0

# BC856ALT1G Series, SBC856ALT1G Series

## BC857/BC858/BC859/SBC857/NSVBC858

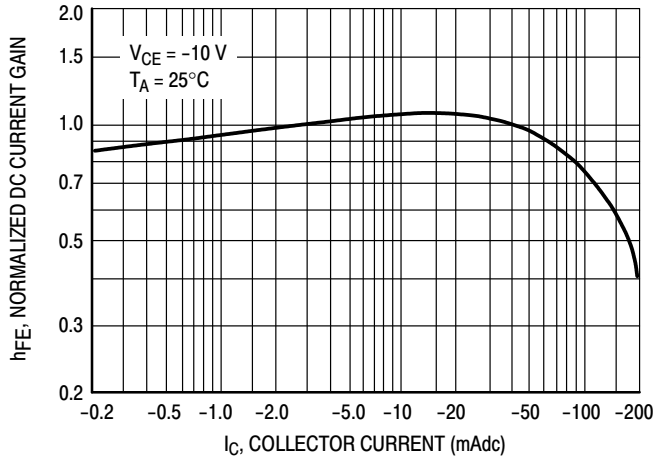

Figure 1. Normalized DC Current Gain

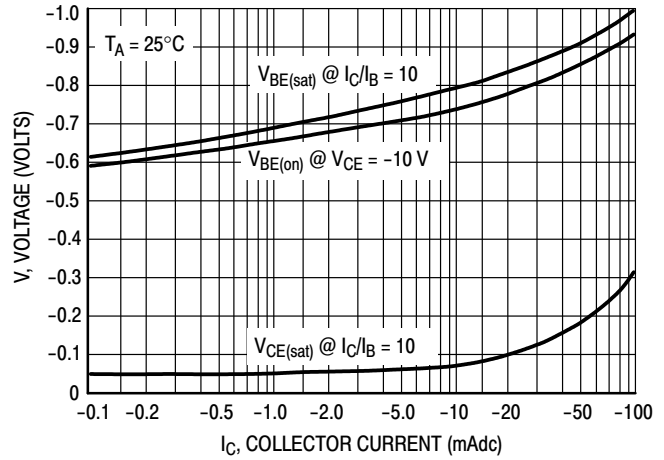

Figure 2. "Saturation" and "On" Voltages

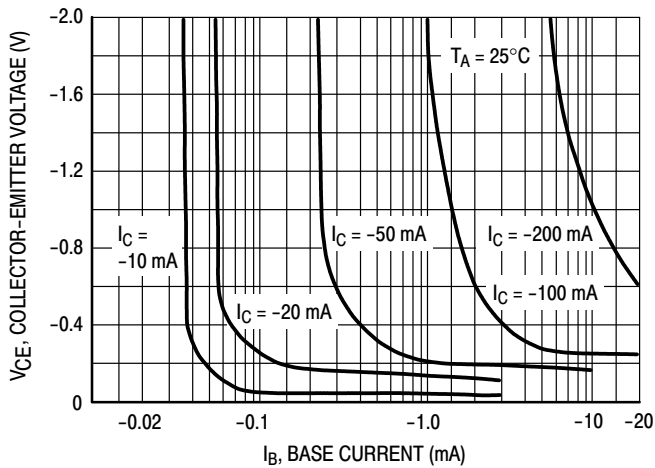

Figure 3. Collector Saturation Region

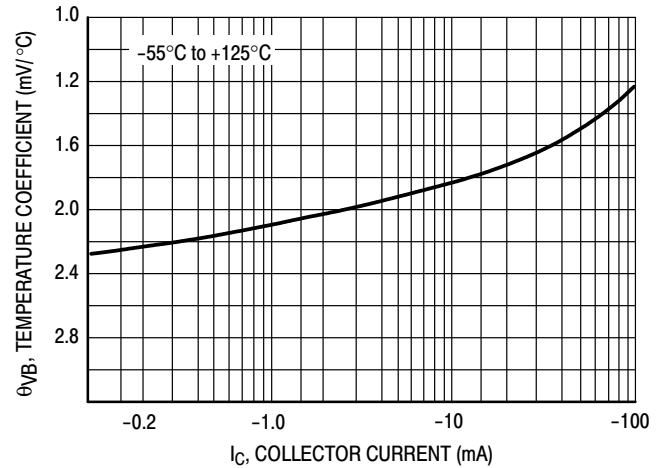

Figure 4. Base-Emitter Temperature Coefficient

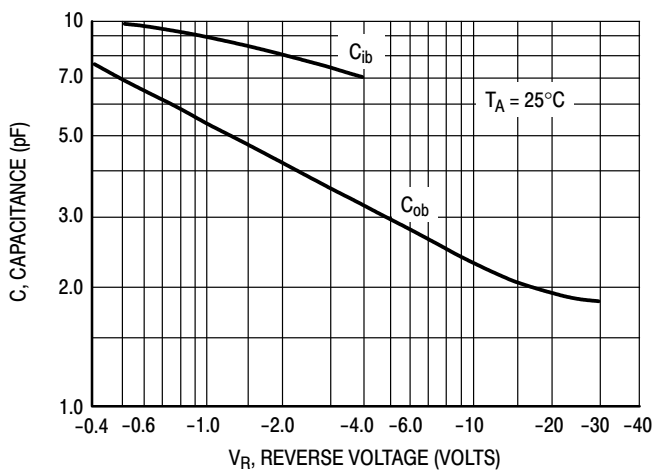

Figure 5. Capacitances

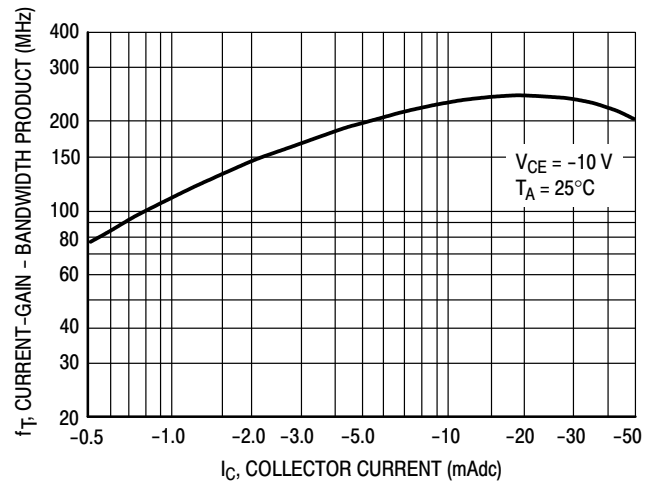

Figure 6. Current-Gain - Bandwidth Product

# BC856ALT1G Series, SBC856ALT1G Series

## BC856/SBC856

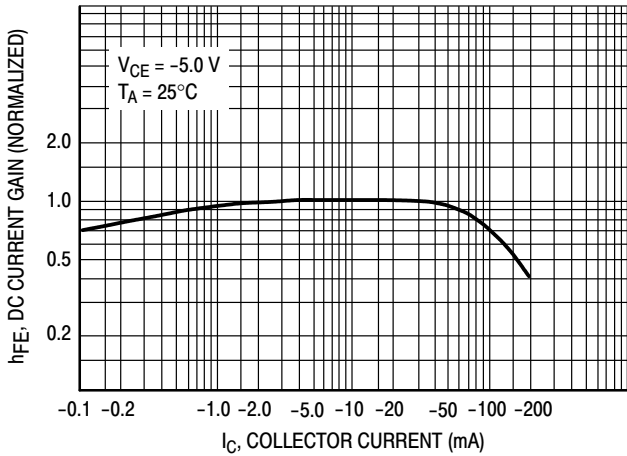

Figure 7. DC Current Gain

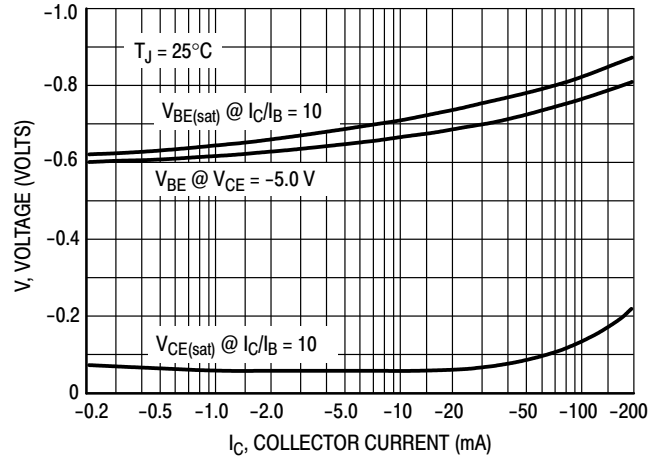

Figure 8. "On" Voltage

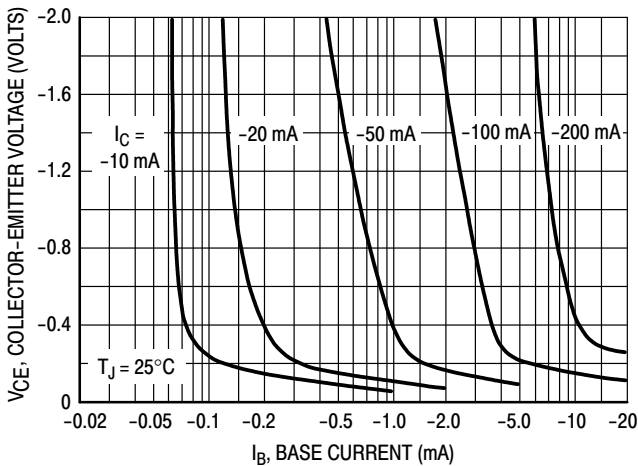

Figure 9. Collector Saturation Region

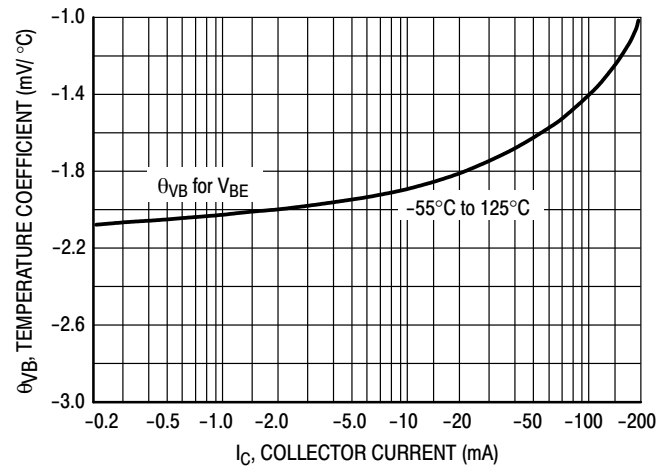

Figure 10. Base-Emitter Temperature Coefficient

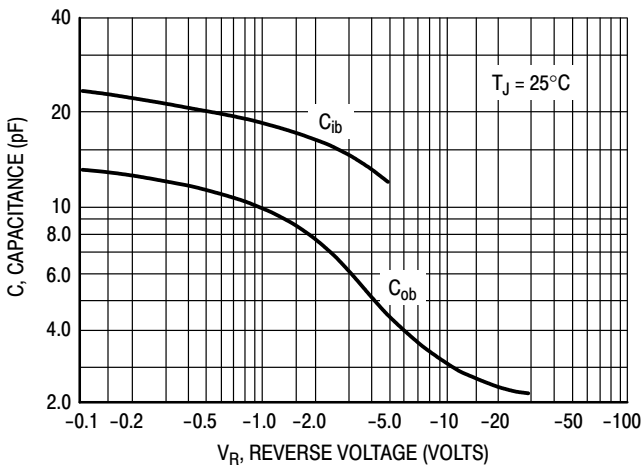

Figure 11. Capacitance

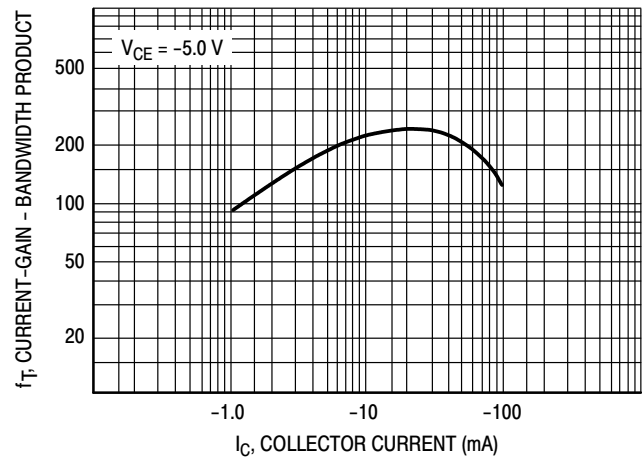
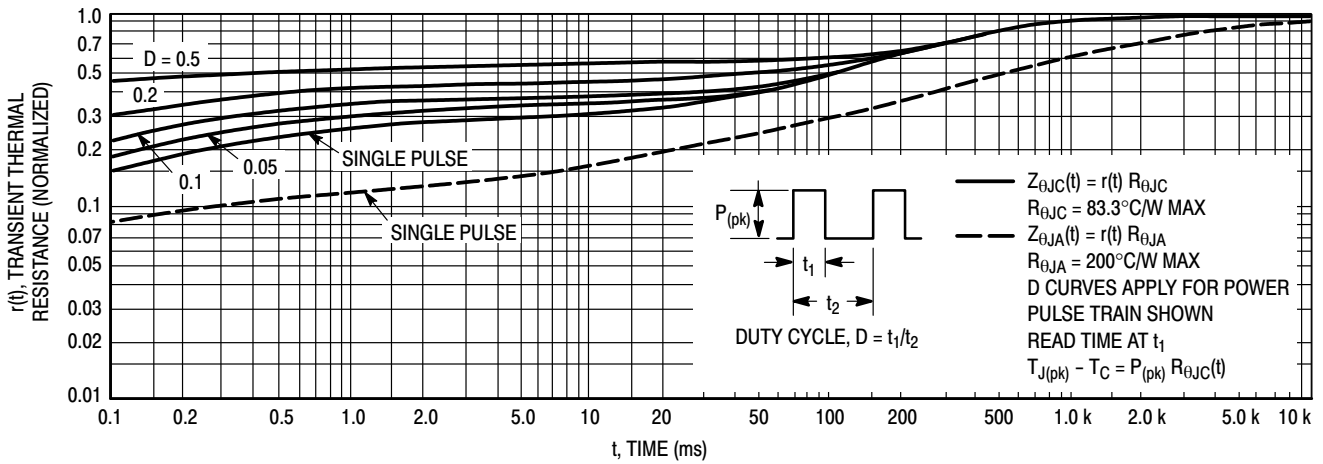
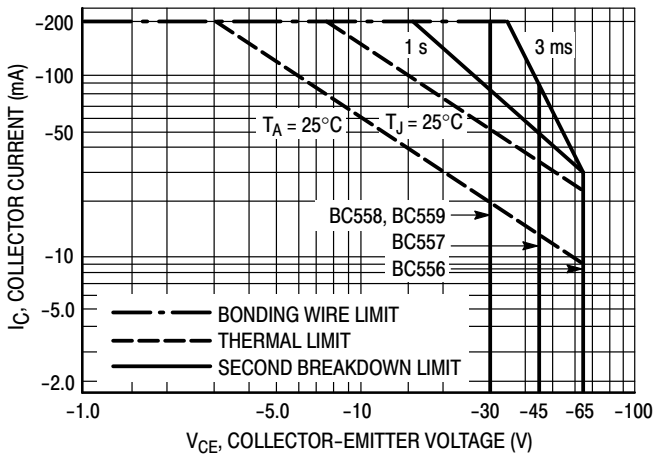

Figure 12. Current-Gain - Bandwidth Product

## BC856ALT1G Series, SBC856ALT1G Series



**Figure 13. Thermal Response**



**Figure 14. Active Region Safe Operating Area**

The safe operating area curves indicate  $I_C$ - $V_{CE}$  limits of the transistor that must be observed for reliable operation. Collector load lines for specific circuits must fall below the limits indicated by the applicable curve.

The data of Figure 14 is based upon  $T_{J(pk)} = 150^\circ\text{C}$ ;  $T_C$  or  $T_A$  is variable depending upon conditions. Pulse curves are valid for duty cycles to 10% provided  $T_{J(pk)} \leq 150^\circ\text{C}$ .  $T_{J(pk)}$  may be calculated from the data in Figure 13. At high case or ambient temperatures, thermal limitations will reduce the power that can be handled to values less than the limitations imposed by the secondary breakdown.

## BC856ALT1G Series, SBC856ALT1G Series

### ORDERING INFORMATION

Device	Marking	Package	Shipping†
BC856ALT1G	3A	SOT-23 (Pb-Free)	3,000 / Tape & Reel
SBC856ALT1G			
BC856ALT3G			10,000 / Tape & Reel
BC856BLT1G	3B	SOT-23 (Pb-Free)	3,000 / Tape & Reel
SBC856BLT1G			
BC856BLT3G			
SBC856BLT3G			10,000 / Tape & Reel
BC857ALT1G	3E	SOT-23 (Pb-Free)	3,000 / Tape & Reel
SBC857ALT1G			
BC857BLT1G	3F	SOT-23 (Pb-Free)	3,000 / Tape & Reel
SBC857BLT1G			
BC857BLT3G			10,000 / Tape & Reel
BC857CLT1G	3G	SOT-23 (Pb-Free)	3,000 / Tape & Reel
SBC857CLT1G			
BC857CLT3G			10,000 / Tape & Reel
BC858ALT1G	3J	SOT-23 (Pb-Free)	3,000 / Tape & Reel
BC858BLT1G	3K	SOT-23 (Pb-Free)	
NSVBC858BLT1G			
BC858BLT3G	3L	SOT-23 (Pb-Free)	10,000 / Tape & Reel
BC858CLT1G		SOT-23 (Pb-Free)	3,000 / Tape & Reel
BC858CLT3G		SOT-23 (Pb-Free)	10,000 / Tape & Reel
BC859BLT1G		4B	SOT-23 (Pb-Free)
BC859BLT3G	SOT-23 (Pb-Free)		10,000 / Tape & Reel
BC859CLT1G	4C	SOT-23 (Pb-Free)	3,000 / Tape & Reel
BC859CLT3G		SOT-23 (Pb-Free)	10,000 / Tape & Reel

†For information on tape and reel specifications, including part orientation and tape sizes, please refer to our Tape and Reel Packaging Specifications Brochure, BRD8011/D.

# BC856ALT1G Series, SBC856ALT1G Series

## PACKAGE DIMENSIONS

SOT-23 (TO-236)  
CASE 318-08  
ISSUE AP

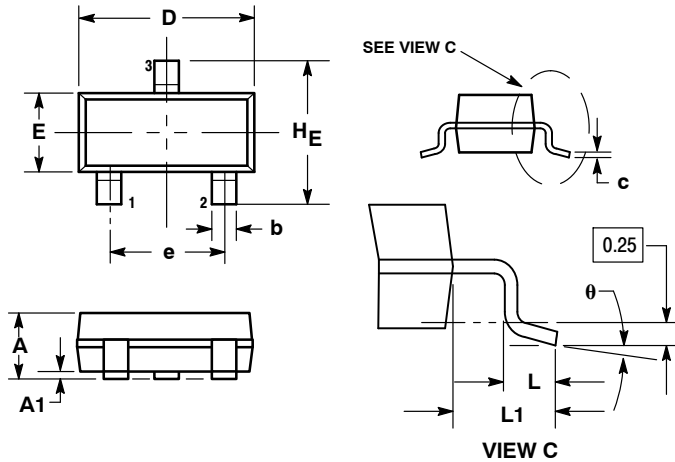

- NOTES:
1. DIMENSIONING AND TOLERANCING PER ANSI Y14.5M, 1982.
  2. CONTROLLING DIMENSION: INCH.
  3. MAXIMUM LEAD THICKNESS INCLUDES LEAD FINISH THICKNESS. MINIMUM LEAD THICKNESS IS THE MINIMUM THICKNESS OF BASE MATERIAL.
  4. DIMENSIONS D AND E DO NOT INCLUDE MOLD FLASH, PROTRUSIONS, OR GATE BURRS.

DIM	MILLIMETERS			INCHES		
	MIN	NOM	MAX	MIN	NOM	MAX
A	0.89	1.00	1.11	0.035	0.040	0.044
A1	0.01	0.06	0.10	0.001	0.002	0.004
b	0.37	0.44	0.50	0.015	0.018	0.020
c	0.09	0.13	0.18	0.003	0.005	0.007
D	2.80	2.90	3.04	0.110	0.114	0.120
E	1.20	1.30	1.40	0.047	0.051	0.055
e	1.78	1.90	2.04	0.070	0.075	0.081
L	0.10	0.20	0.30	0.004	0.008	0.012
L1	0.35	0.54	0.69	0.014	0.021	0.029
HE	2.10	2.40	2.64	0.083	0.094	0.104
θ	0°	---	10°	0°	---	10°

STYLE 6:  
PIN 1. BASE  
2. EMITTER  
3. COLLECTOR

## SOLDERING FOOTPRINT\*

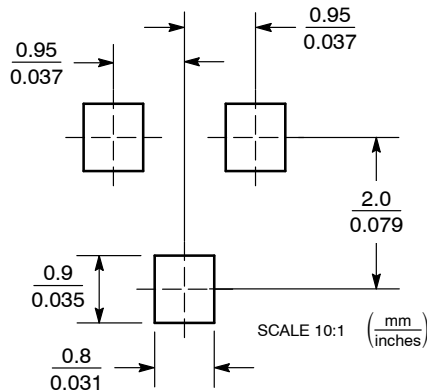

\*For additional information on our Pb-Free strategy and soldering details, please download the ON Semiconductor Soldering and Mounting Techniques Reference Manual, SOLDERRM/D.

ON Semiconductor and are registered trademarks of Semiconductor Components Industries, LLC (SCILLC). SCILLC reserves the right to make changes without further notice to any products herein. SCILLC makes no warranty, representation or guarantee regarding the suitability of its products for any particular purpose, nor does SCILLC assume any liability arising out of the application or use of any product or circuit, and specifically disclaims any and all liability, including without limitation special, consequential or incidental damages. "Typical" parameters which may be provided in SCILLC data sheets and/or specifications can and do vary in different applications and actual performance may vary over time. All operating parameters, including "Typicals" must be validated for each customer application by customer's technical experts. SCILLC does not convey any license under its patent rights nor the rights of others. SCILLC products are not designed, intended, or authorized for use as components in systems intended for surgical implant into the body, or other applications intended to support or sustain life, or for any other application in which the failure of the SCILLC product could create a situation where personal injury or death may occur. Should Buyer purchase or use SCILLC products for any such unintended or unauthorized application, Buyer shall indemnify and hold SCILLC and its officers, employees, subsidiaries, affiliates, and distributors harmless against all claims, costs, damages, and expenses, and reasonable attorney fees arising out of, directly or indirectly, any claim of personal injury or death associated with such unintended or unauthorized use, even if such claim alleges that SCILLC was negligent regarding the design or manufacture of the part. SCILLC is an Equal Opportunity/Affirmative Action Employer. This literature is subject to all applicable copyright laws and is not for resale in any manner.

## PUBLICATION ORDERING INFORMATION

LITERATURE FULFILLMENT:  
Literature Distribution Center for ON Semiconductor  
P.O. Box 5163, Denver, Colorado 80217 USA  
Phone: 303-675-2175 or 800-344-3860 Toll Free USA/Canada  
Fax: 303-675-2176 or 800-344-3867 Toll Free USA/Canada  
Email: orderlit@onsemi.com

N. American Technical Support: 800-282-9855 Toll Free  
USA/Canada  
Europe, Middle East and Africa Technical Support:  
Phone: 421 33 790 2910  
Japan Customer Focus Center  
Phone: 81-3-5817-1050

ON Semiconductor Website: [www.onsemi.com](http://www.onsemi.com)  
Order Literature: <http://www.onsemi.com/orderlit>  
For additional information, please contact your local Sales Representative

[www.BDTIC.com/ON/](http://www.BDTIC.com/ON/)

BC856ALT/D