

BD136, BD138, BD140

Plastic Medium Power Silicon PNP Transistor

This series of plastic, medium-power silicon PNP transistors are designed for use as audio amplifiers and drivers utilizing complementary or quasi complementary circuits.

Features

- DC Current Gain – $h_{FE} = 40$ (Min) @ $I_C = 0.15$ Adc
- BD 136, 138, 140 are complementary with BD 135, 137, 139
- These Devices are Pb-Free, Halogen Free/BFR Free and are RoHS Compliant*

MAXIMUM RATINGS

Rating	Symbol	Value	Unit
Collector-Emitter Voltage	BD136 BD138 BD140	V_{CEO} 45 60 80	Vdc
Collector-Base Voltage	BD136 BD138 BD140	V_{CBO} 45 60 100	Vdc
Emitter-Base Voltage		V_{EBO} 5.0	Vdc
Collector Current		I_C 1.5	Adc
Base Current		I_B 0.5	Adc
Total Device Dissipation @ $T_A = 25^\circ\text{C}$ Derate above 25°C	P_D	1.25 10	Watts mW/ $^\circ\text{C}$
Total Device Dissipation @ $T_C = 25^\circ\text{C}$ Derate above 25°C	P_D	12.5 100	Watts mW/ $^\circ\text{C}$
Operating and Storage Junction Temperature Range	T_J, T_{stg}	-55 to +150	$^\circ\text{C}$

Stresses exceeding Maximum Ratings may damage the device. Maximum Ratings are stress ratings only. Functional operation above the Recommended Operating Conditions is not implied. Extended exposure to stresses above the Recommended Operating Conditions may affect device reliability.

THERMAL CHARACTERISTICS

Characteristic	Symbol	Max	Unit
Thermal Resistance, Junction-to-Case	θ_{JC}	10	$^\circ\text{C}/\text{W}$
Thermal Resistance, Junction-to-Ambient	θ_{JA}	100	$^\circ\text{C}/\text{W}$

*For additional information on our Pb-Free strategy and soldering details, please download the ON Semiconductor Soldering and Mounting Techniques Reference Manual, SOLDERRM/D.



ON Semiconductor®

<http://onsemi.com>

1.5 A POWER TRANSISTORS PNP SILICON 45, 60, 80 V, 12.5 W

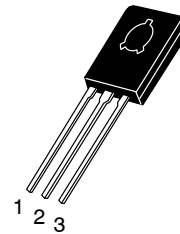

TO-225
CASE 77
STYLE 1

MARKING DIAGRAM

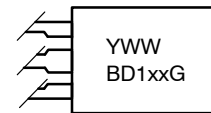

Y = Year
WW = Work Week
xx = 36, 38, 40
G = Pb-Free Package

ORDERING INFORMATION

Device	Package	Shipping†
BD136G	TO-225AA (Pb-Free)	500 Units/Box
BD138G	TO-225AA (Pb-Free)	500 Units/Box
BD140G	TO-225AA (Pb-Free)	500 Units/Box

†For information on tape and reel specifications, including part orientation and tape sizes, please refer to our Tape and Reel Packaging Specifications Brochure, BRD8011/D.

BD136, BD138, BD140

ELECTRICAL CHARACTERISTICS ($T_C = 25^\circ\text{C}$ unless otherwise noted)

Characteristic	Symbol	Type	Min	Max	Unit
Collector–Emitter Sustaining Voltage* ($I_C = 0.03\text{ A}$, $I_B = 0$)	BV_{CEO}	BD 136 BD 138 BD 140	45 60 80	– – –	Vdc
Collector Cutoff Current ($V_{CB} = 30\text{ Vdc}$, $I_E = 0$) ($V_{CB} = 30\text{ Vdc}$, $I_E = 0$, $T_C = 125^\circ\text{C}$)	I_{CBO}		– –	0.1 10	μA dc
Emitter Cutoff Current ($V_{BE} = 5.0\text{ Vdc}$, $I_C = 0$)	I_{EBO}		–	10	μA dc
DC Current Gain ($I_C = 0.005\text{ A}$, $V_{CE} = 2\text{ V}$) ($I_C = 0.15\text{ A}$, $V_{CE} = 2\text{ V}$) ($I_C = 0.5\text{ A}$, $V_{CE} = 2\text{ V}$)	h_{FE}^*		25 40 25	– 250 –	–
Collector–Emitter Saturation Voltage* ($I_C = 0.5\text{ A}$ dc, $I_B = 0.05\text{ A}$ dc)	$V_{CE(sat)}^*$		–	0.5	Vdc
Base–Emitter On Voltage* ($I_C = 0.5\text{ A}$ dc, $V_{CE} = 2.0\text{ Vdc}$)	$V_{BE(on)}^*$		–	1	Vdc

*Pulse Test: Pulse Width $\leq 300\ \mu\text{s}$, Duty Cycle $\leq 2.0\%$.

TYPICAL CHARACTERISTICS

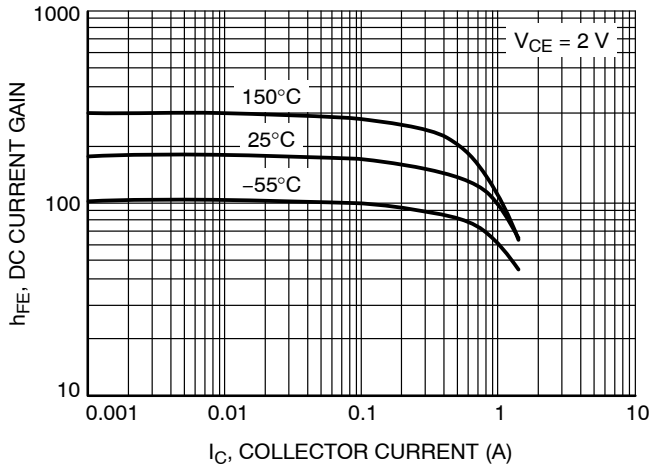

Figure 1. DC Current Gain

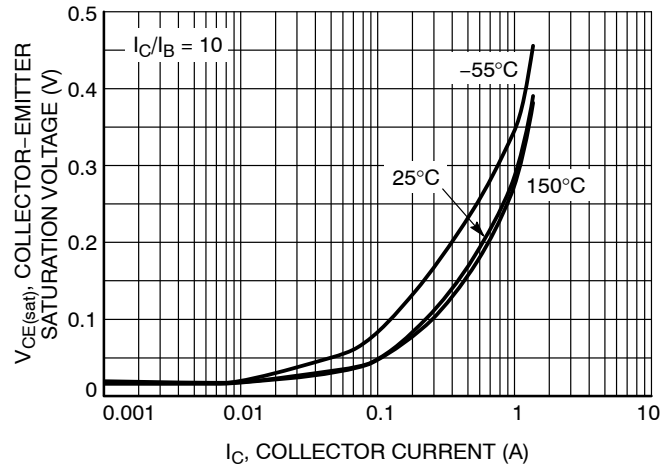

Figure 2. Collector–Emitter Saturation Voltage

BD136, BD138, BD140

TYPICAL CHARACTERISTICS

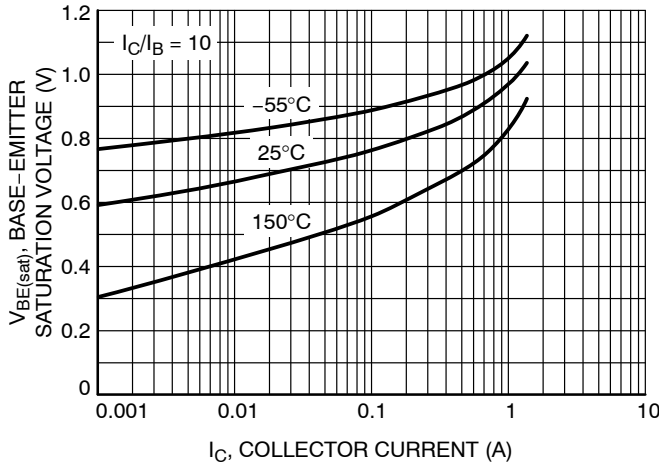

Figure 3. Base-Emitter Saturation Voltage

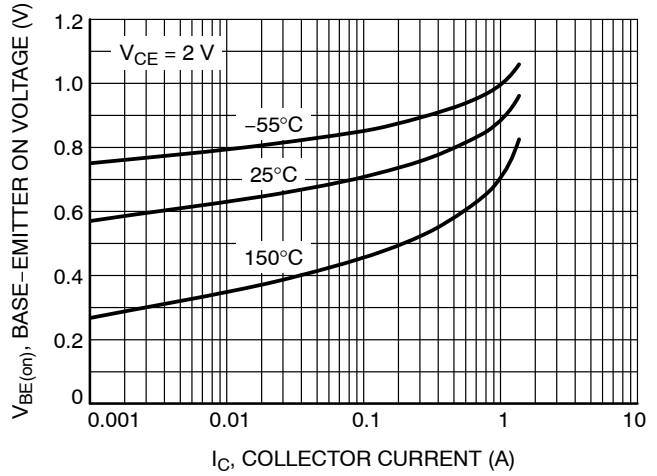

Figure 4. Base-Emitter On Voltage

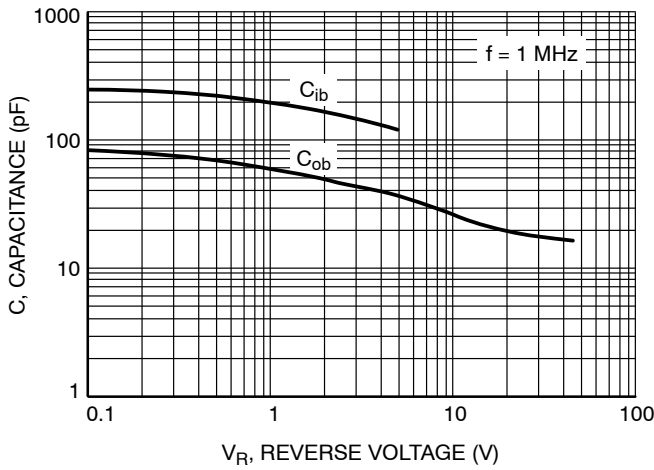

Figure 5. Capacitance

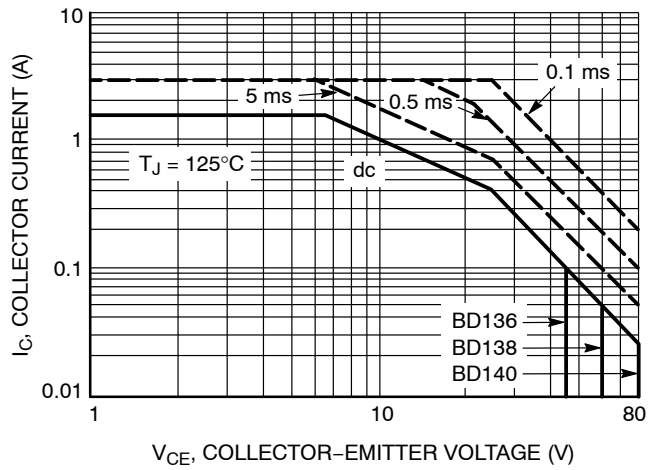

Figure 6. Active-Region Safe Operating Area

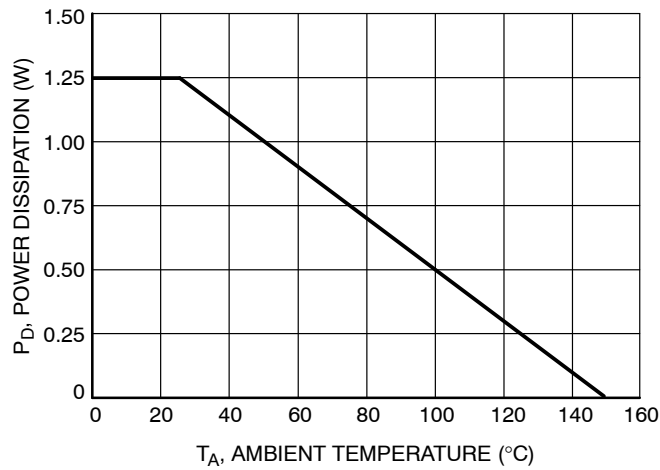
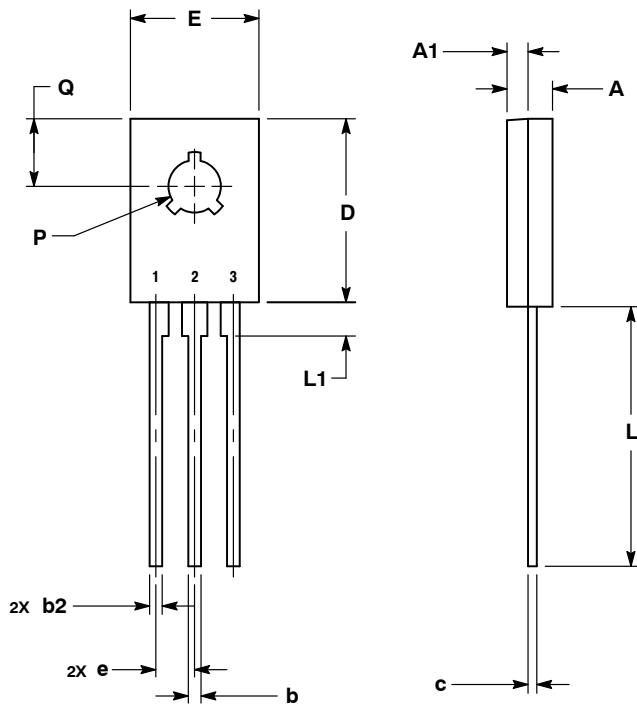

Figure 7. Power Derating

BD136, BD138, BD140

PACKAGE DIMENSIONS

TO-225
CASE 77-09
ISSUE AA



NOTES:

1. DIMENSIONING AND TOLERANCING PER ASME Y14.5M, 1994.
2. CONTROLLING DIMENSION: MILLIMETERS.
3. NUMBER AND SHAPE OF LUGS OPTIONAL.

DIM	MILLIMETERS	
	MIN	MAX
A	2.40	3.00
A1	1.00	1.50
b	0.60	0.90
b2	0.51	0.88
c	0.39	0.63
D	10.60	11.10
E	7.40	7.80
e	2.04	2.54
L	14.50	16.63
L1	1.27	2.54
P	2.90	3.30
Q	3.80	4.20

STYLE 1:

- PIN 1. EMITTER
- COLLECTOR
- BASE

ON Semiconductor and are registered trademarks of Semiconductor Components Industries, LLC (SCILLC). SCILLC owns the rights to a number of patents, trademarks, copyrights, trade secrets, and other intellectual property. A listing of SCILLC's product/patent coverage may be accessed at www.onsemi.com/site/pdf/Patent-Marking.pdf. SCILLC reserves the right to make changes without further notice to any products herein. SCILLC makes no warranty, representation or guarantee regarding the suitability of its products for any particular purpose, nor does SCILLC assume any liability arising out of the application or use of any product or circuit, and specifically disclaims any and all liability, including without limitation special, consequential or incidental damages. "Typical" parameters which may be provided in SCILLC data sheets and/or specifications can and do vary in different applications and actual performance may vary over time. All operating parameters, including "Typicals" must be validated for each customer application by customer's technical experts. SCILLC does not convey any license under its patent rights nor the rights of others. SCILLC products are not designed, intended, or authorized for use as components in systems intended for surgical implant into the body, or other applications intended to support or sustain life, or for any other application in which the failure of the SCILLC product could create a situation where personal injury or death may occur. Should Buyer purchase or use SCILLC products for any such unintended or unauthorized application, Buyer shall indemnify and hold SCILLC and its officers, employees, subsidiaries, affiliates, and distributors harmless against all claims, costs, damages, and expenses, and reasonable attorney fees arising out of, directly or indirectly, any claim of personal injury or death associated with such unintended or unauthorized use, even if such claim alleges that SCILLC was negligent regarding the design or manufacture of the part. SCILLC is an Equal Opportunity/Affirmative Action Employer. This literature is subject to all applicable copyright laws and is not for resale in any manner.

PUBLICATION ORDERING INFORMATION

LITERATURE FULFILLMENT:

Literature Distribution Center for ON Semiconductor
P.O. Box 5163, Denver, Colorado 80217 USA
Phone: 303-675-2175 or 800-344-3860 Toll Free USA/Canada
Fax: 303-675-2176 or 800-344-3867 Toll Free USA/Canada
Email: orderlit@onsemi.com

N. American Technical Support: 800-282-9855 Toll Free
USA/Canada
Europe, Middle East and Africa Technical Support:
Phone: 421 33 790 2910
Japan Customer Focus Center
Phone: 81-3-5817-1050

ON Semiconductor Website: www.onsemi.com

Order Literature: <http://www.onsemi.com/orderlit>

For additional information, please contact your local Sales Representative