

BD243B, BD243C (NPN) BD244B, BD244C (PNP)



ON Semiconductor®

<http://onsemi.com>

Complementary Silicon Plastic Power Transistors

These devices are designed for use in general purpose amplifier and switching applications.

Features

- Collector – Emitter Saturation Voltage –
 $V_{CE(sat)} = 1.5 \text{ Vdc (Max) @ } I_C = 6.0 \text{ Adc}$
- Collector Emitter Sustaining Voltage –
 $V_{CEO(sus)} = 80 \text{ Vdc (Min) – BD243B, BD244B}$
 $= 100 \text{ Vdc (Min) – BD243C, BD244C}$
- High Current Gain Bandwidth Product
 $f_T = 3.0 \text{ MHz (Min) @ } I_C = 500 \text{ mAdc}$
- Pb-Free Packages are Available*

**6 AMPERE
POWER TRANSISTORS
COMPLEMENTARY SILICON
80–100 VOLTS
65 WATTS**

MAXIMUM RATINGS

| Rating | Symbol | Value | Unit |
|--|----------------|-------------|--------------------------|
| Collector–Emitter Voltage BD243B, BD244B BD243C, BD244C | V_{CEO} | 80 100 | Vdc |
| Collector–Base Voltage BD243B, BD244B BD243C, BD244C | V_{CB} | 80 100 | Vdc |
| Emitter–Base Voltage | V_{EB} | 5.0 | Vdc |
| Collector Current – Continuous – Peak | I_C | 6 10 | Adc |
| Base Current | I_B | 2.0 | Adc |
| Total Device Dissipation @ $T_C = 25^\circ\text{C}$ Derate above 25°C | P_D | 65 0.52 | W W/ $^\circ\text{C}$ |
| Operating and Storage Junction Temperature Range | T_J, T_{stg} | -65 to +150 | $^\circ\text{C}$ |

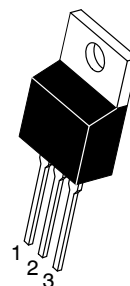

TO-220AB
CASE 221A-09
STYLE 1

MARKING DIAGRAM



BD24xy = Device Code
x = 3 or 4
y = B or C
A = Assembly Location
Y = Year
WW = Work Week
G = Pb-Free Package

THERMAL CHARACTERISTICS

| Characteristics | Symbol | Max | Unit |
|--------------------------------------|-----------------|------|--------------------|
| Thermal Resistance, Junction-to-Case | $R_{\theta JC}$ | 1.92 | $^\circ\text{C/W}$ |

Stresses exceeding Maximum Ratings may damage the device. Maximum Ratings are stress ratings only. Functional operation above the Recommended Operating Conditions is not implied. Extended exposure to stresses above the Recommended Operating Conditions may affect device reliability.

ORDERING INFORMATION

See detailed ordering and shipping information in the package dimensions section on page 5 of this data sheet.

*For additional information on our Pb-Free strategy and soldering details, please download the ON Semiconductor Soldering and Mounting Techniques Reference Manual, SOLDERRM/D.

BD243B, BD243C (NPN) BD244B, BD244C (PNP)

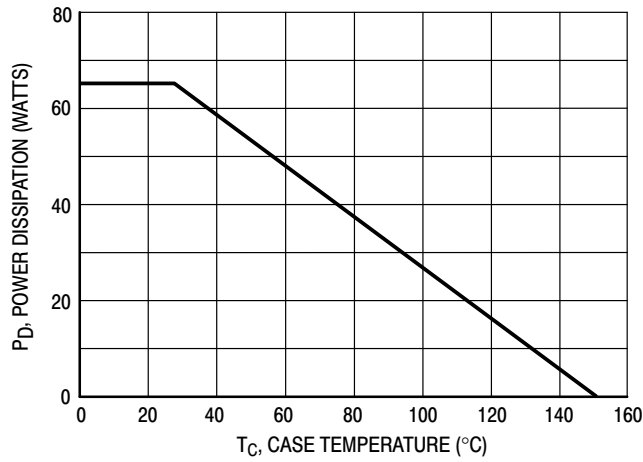

Figure 1. Power Derating

ELECTRICAL CHARACTERISTICS ($T_C = 25^\circ\text{C}$ unless otherwise noted)

| Characteristic | Symbol | Min | Max | Unit |
|---|----------------|-----------|------------|-----------------|
| Collector-Emitter Sustaining Voltage (Note 1) ($I_C = 30 \text{ mAdc}$, $I_B = 0$) | $V_{CEO(sus)}$ | 80 100 | - - | Vdc |
| Collector Cutoff Current ($V_{CE} = 60 \text{ Vdc}$, $I_B = 0$) | I_{CEO} | - | 0.7 | mAdc |
| Collector Cutoff Current ($V_{CE} = 80 \text{ Vdc}$, $V_{EB} = 0$) ($V_{CE} = 100 \text{ Vdc}$, $V_{EB} = 0$) | I_{CES} | - - | 400 400 | μAdc |
| Emitter Cutoff Current ($V_{BE} = 5.0 \text{ Vdc}$, $I_C = 0$) | I_{EBO} | - | 1.0 | mAdc |

ON CHARACTERISTICS (Note 1)

| | | | | |
|---|---------------|----------|--------|-----|
| DC Current Gain ($I_C = 0.3 \text{ Adc}$, $V_{CE} = 4.0 \text{ Vdc}$) ($I_C = 3.0 \text{ Adc}$, $V_{CE} = 4.0 \text{ Vdc}$) | h_{FE} | 30 15 | - - | - |
| Collector-Emitter Saturation Voltage ($I_C = 6.0 \text{ Adc}$, $I_B = 1.0 \text{ Adc}$) | $V_{CE(sat)}$ | - | 1.5 | Vdc |
| Base-Emitter On Voltage ($I_C = 6.0 \text{ Adc}$, $V_{CE} = 4.0 \text{ Vdc}$) | $V_{BE(on)}$ | - | 2.0 | Vdc |

DYNAMIC CHARACTERISTICS

| | | | | |
|--|----------|-----|---|-----|
| Current-Gain - Bandwidth Product (Note 2) ($I_C = 500 \text{ mAdc}$, $V_{CE} = 10 \text{ Vdc}$, $f_{test} = 1.0 \text{ MHz}$) | f_T | 3.0 | - | MHz |
| Small-Signal Current Gain ($I_C = 0.5 \text{ Adc}$, $V_{CE} = 10 \text{ Vdc}$, $f = 1.0 \text{ kHz}$) | h_{fe} | 20 | - | - |

1. Pulse Test: Pulsewidth $\leq 300 \mu\text{s}$, Duty Cycle $\leq 2.0\%$.
2. $f_T = h_{fe} \cdot f_{test}$

BD243B, BD243C (NPN) BD244B, BD244C (PNP)

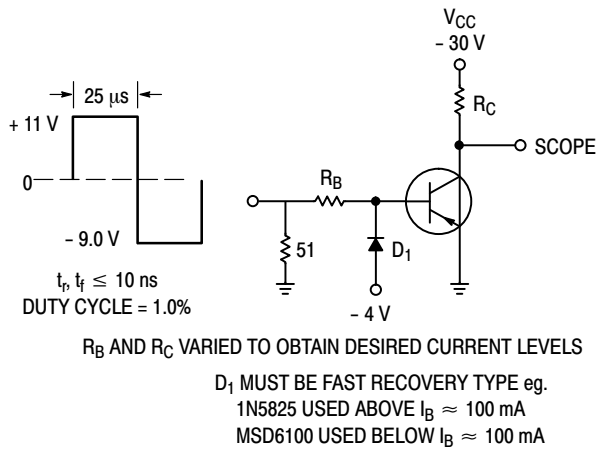

Figure 2. Switching Time Test Circuit

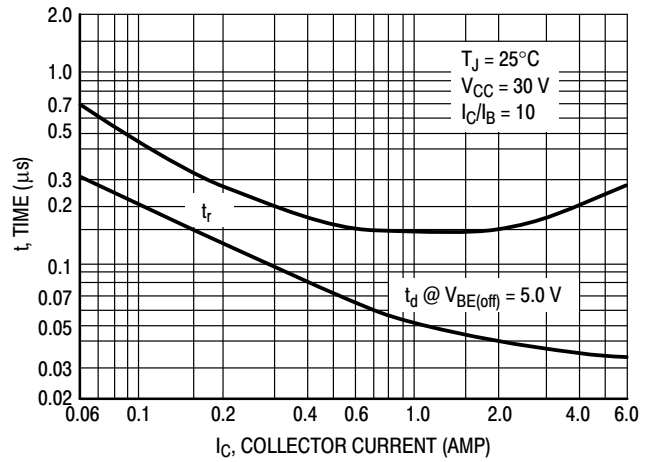

Figure 3. Turn-On Time

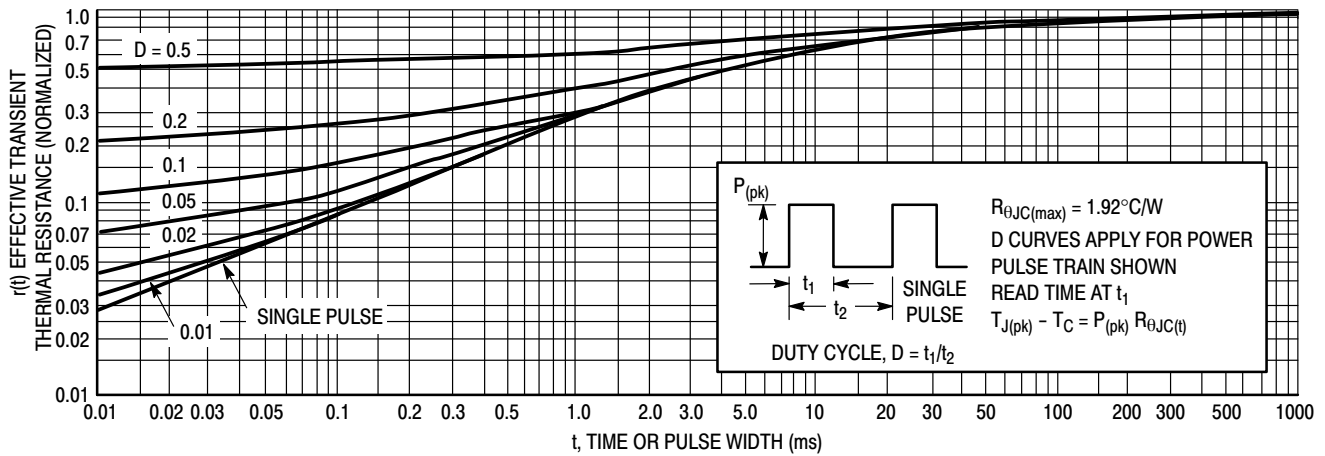

Figure 4. Thermal Response

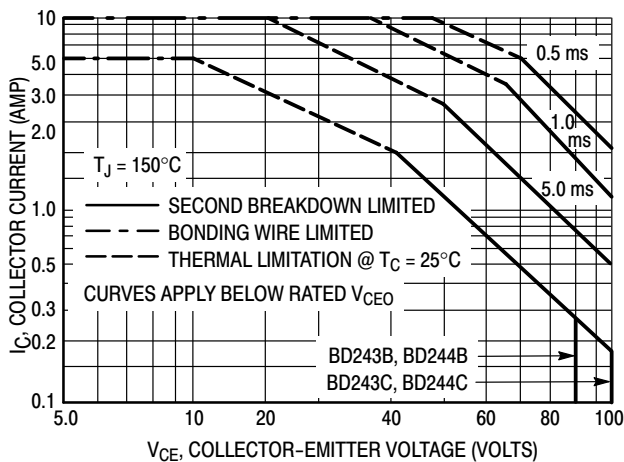

Figure 5. Active Region Safe Operating Area

There are two limitations on the power handling ability of a transistor: average junction temperature and second breakdown. Safe operating area curves indicate $I_C - V_{CE}$ limits of the transistor that must be observed for reliable operation, i.e., the transistor must not be subjected to greater dissipation than the curves indicate.

The data of Figure 5 is based on $T_{J(pk)} = 150^\circ\text{C}$; T_C is variable depending on conditions. Second breakdown pulse limits are valid for duty cycles to 10% provided $T_{J(pk)} \leq 150^\circ\text{C}$, $T_{J(pk)}$ may be calculated from the data in Figure 4. At high case temperatures, thermal limitations will reduce the power that can be handled to values less than the limitations imposed by second breakdown.

BD243B, BD243C (NPN) BD244B, BD244C (PNP)

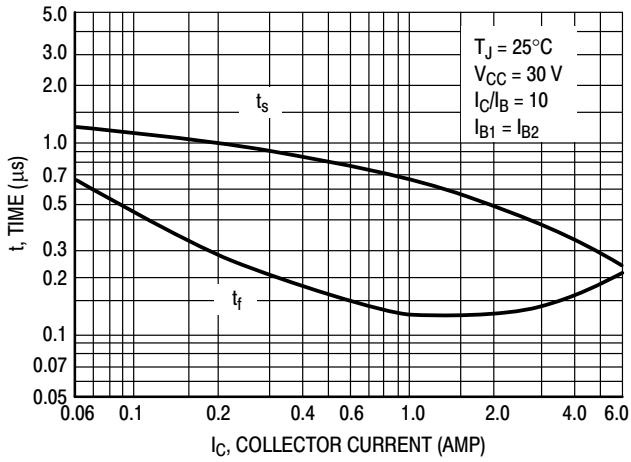

Figure 6. Turn-Off Time

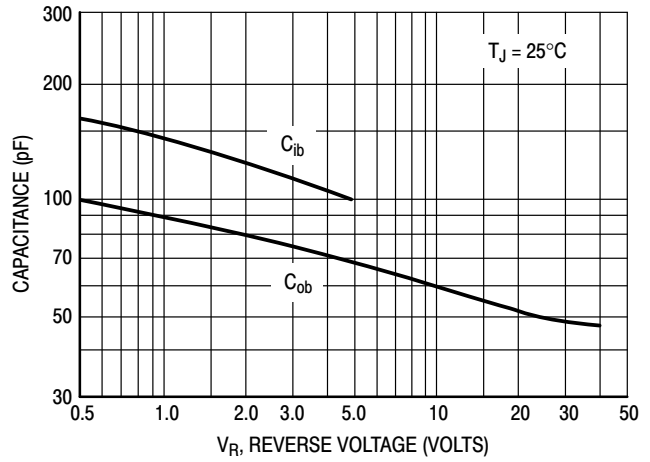

Figure 7. Capacitance

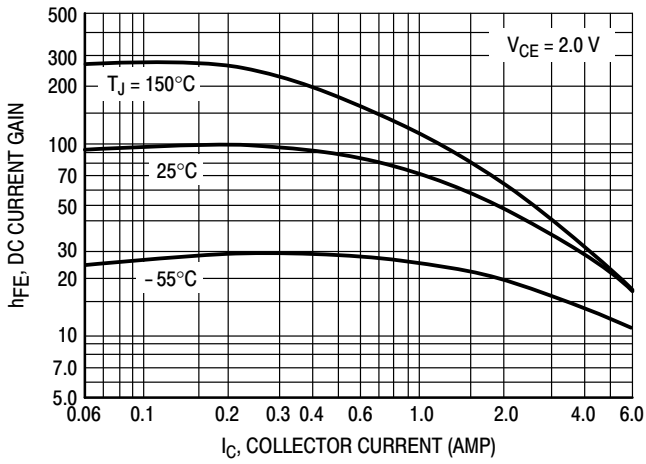

Figure 8. DC Current Gain

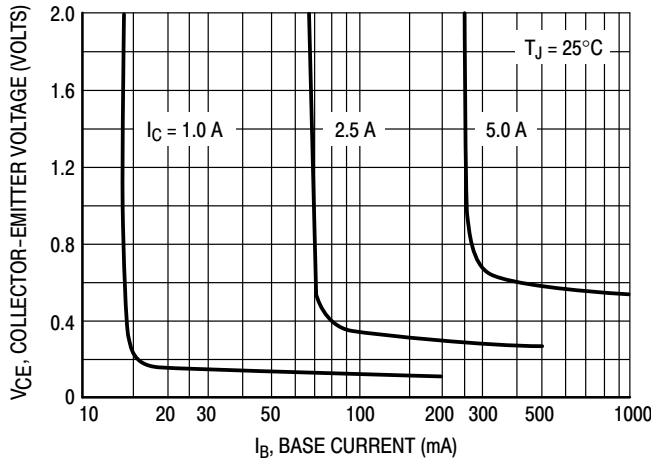

Figure 9. Collector Saturation Region

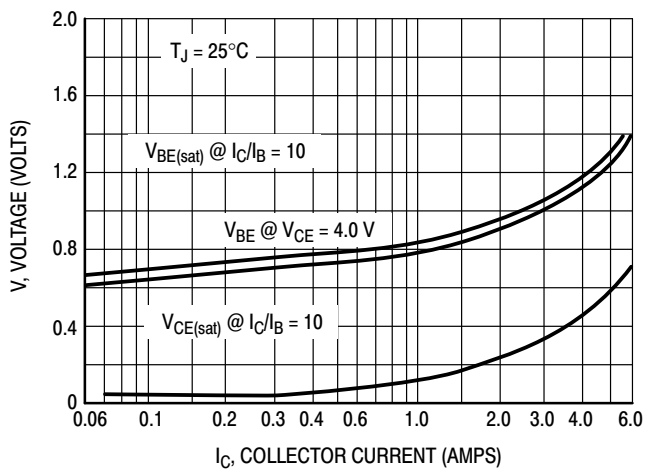

Figure 10. "On" Voltages

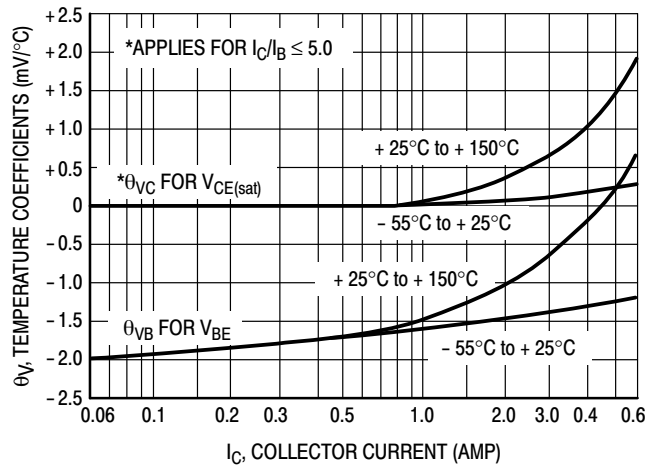

Figure 11. Temperature Coefficients

BD243B, BD243C (NPN) BD244B, BD244C (PNP)

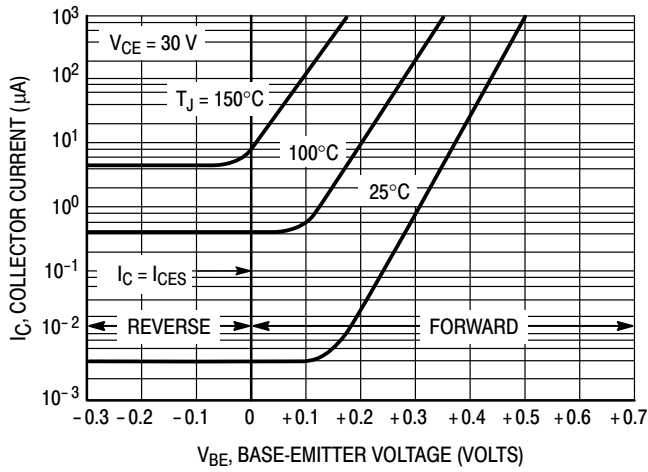

Figure 12. Collector Cut-Off Region

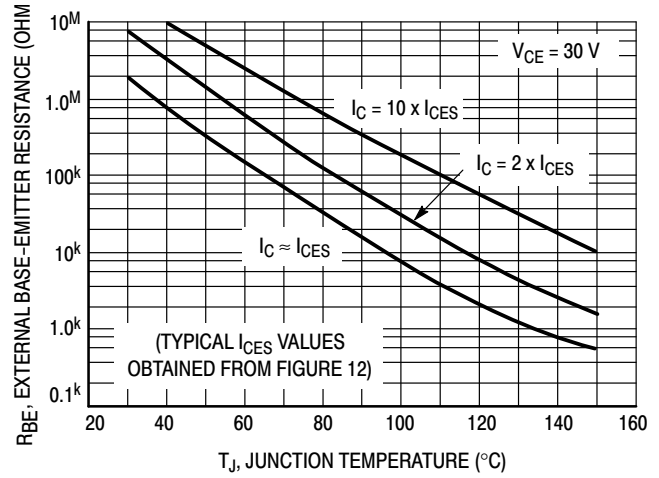

Figure 13. Effects of Base-Emitter Resistance

ORDERING INFORMATION

| Device | Package | Shipping† |
|---------|---------------------|-----------------|
| BD243B | TO-220 | 50 Units / Rail |
| BD243BG | TO-220 (Pb-Free) | |
| BD243C | TO-220 | 50 Units / Rail |
| BD243CG | TO-220 (Pb-Free) | |
| BD244B | TO-220 | 50 Units / Rail |
| BD244BG | TO-220 (Pb-Free) | |
| BD244C | TO-220 | 50 Units / Rail |
| BD244CG | TO-220 (Pb-Free) | |

†For information on tape and reel specifications, including part orientation and tape sizes, please refer to our Tape and Reel Packaging Specifications Brochure, BRD8011/D.

BD243B, BD243C (NPN) BD244B, BD244C (PNP)

PACKAGE DIMENSIONS

TO-220
CASE 221A-09
ISSUE AG

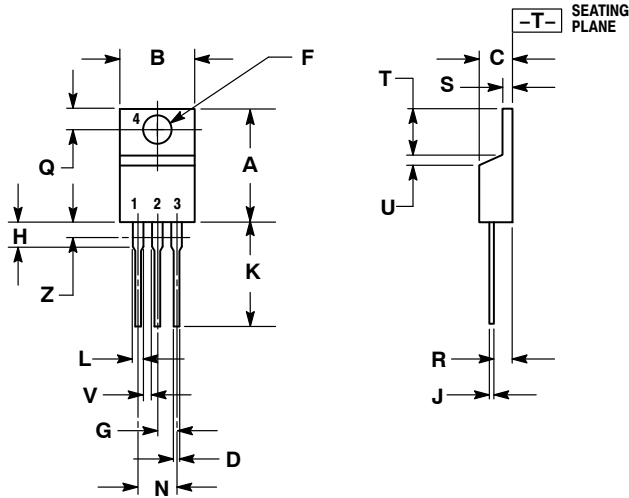

NOTES:

1. DIMENSIONING AND TOLERANCING PER ANSI Y14.5M, 1982.
2. CONTROLLING DIMENSION: INCH.
3. DIMENSION Z DEFINES A ZONE WHERE ALL BODY AND LEAD IRREGULARITIES ARE ALLOWED.

| DIM | INCHES | | MILLIMETERS | |
|-----|--------|-------|-------------|-------|
| | MIN | MAX | MIN | MAX |
| A | 0.570 | 0.620 | 14.48 | 15.75 |
| B | 0.380 | 0.405 | 9.66 | 10.28 |
| C | 0.160 | 0.190 | 4.07 | 4.82 |
| D | 0.025 | 0.036 | 0.64 | 0.91 |
| F | 0.142 | 0.161 | 3.61 | 4.09 |
| G | 0.095 | 0.105 | 2.42 | 2.66 |
| H | 0.110 | 0.161 | 2.80 | 4.10 |
| J | 0.014 | 0.025 | 0.36 | 0.64 |
| K | 0.500 | 0.562 | 12.70 | 14.27 |
| L | 0.045 | 0.060 | 1.15 | 1.52 |
| N | 0.190 | 0.210 | 4.83 | 5.33 |
| Q | 0.100 | 0.120 | 2.54 | 3.04 |
| R | 0.080 | 0.110 | 2.04 | 2.79 |
| S | 0.045 | 0.055 | 1.15 | 1.39 |
| T | 0.235 | 0.255 | 5.97 | 6.47 |
| U | 0.000 | 0.050 | 0.00 | 1.27 |
| V | 0.045 | --- | 1.15 | --- |
| Z | --- | 0.080 | --- | 2.04 |

STYLE 1:

- PIN 1. BASE
2. COLLECTOR
3. EMITTER
4. COLLECTOR

ON Semiconductor and are registered trademarks of Semiconductor Components Industries, LLC (SCILLC). SCILLC reserves the right to make changes without further notice to any products herein. SCILLC makes no warranty, representation or guarantee regarding the suitability of its products for any particular purpose, nor does SCILLC assume any liability arising out of the application or use of any product or circuit, and specifically disclaims any and all liability, including without limitation special, consequential or incidental damages. "Typical" parameters which may be provided in SCILLC data sheets and/or specifications can and do vary in different applications and actual performance may vary over time. All operating parameters, including "Typicals" must be validated for each customer application by customer's technical experts. SCILLC does not convey any license under its patent rights nor the rights of others. SCILLC products are not designed, intended, or authorized for use as components in systems intended for surgical implant into the body, or other applications intended to support or sustain life, or for any other application in which the failure of the SCILLC product could create a situation where personal injury or death may occur. Should Buyer purchase or use SCILLC products for any such unintended or unauthorized application, Buyer shall indemnify and hold SCILLC and its officers, employees, subsidiaries, affiliates, and distributors harmless against all claims, costs, damages, and expenses, and reasonable attorney fees arising out of, directly or indirectly, any claim of personal injury or death associated with such unintended or unauthorized use, even if such claim alleges that SCILLC was negligent regarding the design or manufacture of the part. SCILLC is an Equal Opportunity/Affirmative Action Employer. This literature is subject to all applicable copyright laws and is not for resale in any manner.

PUBLICATION ORDERING INFORMATION

LITERATURE FULFILLMENT:
Literature Distribution Center for ON Semiconductor
P.O. Box 5163, Denver, Colorado 80217 USA
Phone: 303-675-2175 or 800-344-3860 Toll Free USA/Canada
Fax: 303-675-2176 or 800-344-3867 Toll Free USA/Canada
Email: orderlit@onsemi.com

N. American Technical Support: 800-282-9855 Toll Free
USA/Canada
Europe, Middle East and Africa Technical Support:
Phone: 421 33 790 2910
Japan Customer Focus Center
Phone: 81-3-5817-1050

ON Semiconductor Website: www.onsemi.com
Order Literature: <http://www.onsemi.com/orderlit>
For additional information, please contact your local Sales Representative