

CAT808

Low-Power Precision Voltage Detector

Description

The CAT808 is a high-precision voltage detector designed for monitoring single cell and multi-cell batteries. Voltage detection thresholds between 2.0 V and 3.5 V are provided with 0.1 V resolution and $\pm 3.0\%$ accuracy.

The CAT808 open-drain output is active low until the V_{DD} voltage exceeds the detection threshold. A low hysteresis is built into the device to minimize output “chatter”, while V_{DD} passes through the detection threshold, and the output transitions high.

After the CAT808 asserts the output high condition, it continues to monitor V_{DD} until it drops below the detection threshold, when the output goes low until V_{DD} once again exceeds the detection threshold.

Features

- Ultra Low Current Consumption 2.4 μA
- Accurate Voltage Detection Threshold
- Fine Voltage Detection Threshold Resolution
- Open Drain Output (Active Low)
- Industrial Temperature Range -40°C to $+85^{\circ}\text{C}$
- 5-pin TSOT-23
- These Devices are Pb-Free, Halogen Free/BFR Free and are RoHS Compliant

Applications

- Battery-Powered Systems
- Power Supply Monitoring
- Handheld and Portable Equipment
- Processor Supervisor Reset

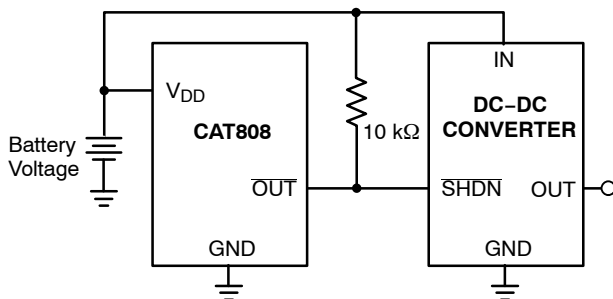

Note: The value of the pull-up resistor is not critical

Figure 1. Typical Application



ON Semiconductor[®]

<http://onsemi.com>



**TSOT-5
TD SUFFIX
CASE 419AE**

MARKING DIAGRAM

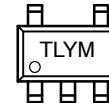

TL = Specific Device Code
Y = Production Year
M = Production Month

PIN CONNECTIONS

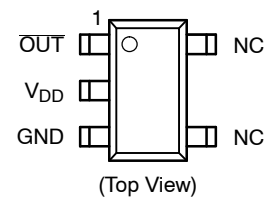

ORDERING INFORMATION

See detailed ordering and shipping information in the package dimensions section on page 6 of this data sheet.

CAT808

Table 1. ABSOLUTE MAXIMUM RATINGS

Parameters	Ratings	Units
Temperature under Bias	-55 to +125	°C
Storage Temperature	-65 to +150	°C
Voltage on any Pin with Respect to GND (Notes 1, 2)	-2.0 to V _{DD} + 2.0	V
V _{DD} with Respect to GND	-2.0 to 7.0	V
Lead Soldering temperature (10 seconds)	+300	°C
Power Dissipation	250	mW

Stresses exceeding Maximum Ratings may damage the device. Maximum Ratings are stress ratings only. Functional operation above the Recommended Operating Conditions is not implied. Extended exposure to stresses above the Recommended Operating Conditions may affect device reliability.

- The Minimum DC input voltage is -0.5 V. During transitions, inputs may undershoot to -2.0 V for periods of less than 20 ns. Maximum DC voltage on output pins is V_{CC} +0.5 V, which may overshoot to V_{CC} +2.0 V for periods of less than 20 ns.
- Latch-up protection is provided for stresses up to 100 mA on all pins from -1 V to V_{CC} +1 V.

Table 2. RECOMMENDED OPERATING CONDITIONS

Parameters	Ratings	Units
V _{DD}	+1.2 to +6.0	V
Operating Temperature Range	-40 to +85	°C

Table 3. DC ELECTRICAL CHARACTERISTICS (T_A = -40°C to +85°C, V_{DD} = 1.2 V to 6.0 V)

Symbol	Parameter	Conditions	Min	Typ	Max	Units	
V _{DET}	Detection Voltage	CAT808Nxxx-25	2.43	2.5	2.57	V	
		CAT808Nxxx-27	2.62	2.7	2.78		
		CAT808Nxxx-32	3.12	3.2	3.28		
		CAT808Nxxx-35	3.42	3.5	3.58		
I _{DD}	Current Consumption	V _{DD} = 4.0 V	-	2.4	5	μA	
		V _{DD} = 5.0 V	-	3.5	7		
		V _{DD} = 6.0 V	-	5	10		
I _{OUT}	Output Sink Current	V _{DS} = 0.5 V	V _{DD} = 1.2 V	0.6	1.4	-	mA
			V _{DD} = 2.4 V	2.9	5	-	
I _{LEAK}	Output Leakage Current	V _{DS} = 5.0 V, V _{DD} = 5.0 V	-	-	1	μA	
T _{PHL/LH}	Response Time	-	-	-	60	μs	
$\frac{\Delta V_{DET}}{\Delta T_A} \cdot V_{DET}(typ)$	Detection Voltage Temperature Coefficient (Note 3)		-	±10	±100	ppm/°C	

- The temperature change ratio in the detection voltage [ppm/°C] is calculated by using the following equation:

$$\frac{\Delta V_{DET}}{\Delta T_A \cdot V_{DET}(typ)} \times 1,000,000 [ppm/°C]$$

CAT808

Operation – Voltage Detector

The CAT808 has an active low output that asserts (pulls low) when the supply voltage drops below the detection threshold voltage (V_{DET}). The open-drain output requires an external pull-up resistor between the output pin and the supply voltage (as shown in the typical application diagram). On power-up, \overline{OUT} is held active low until the supply voltage (V_{DD}) rises above V_{DET} . While V_{DD} is above V_{DET} , \overline{OUT} stays high until V_{DD} drops below V_{DET} , then \overline{OUT} once again goes low.

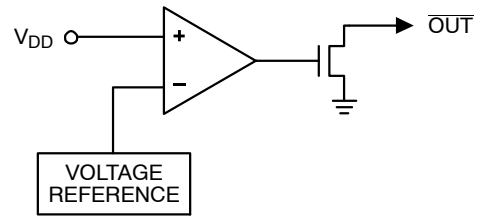
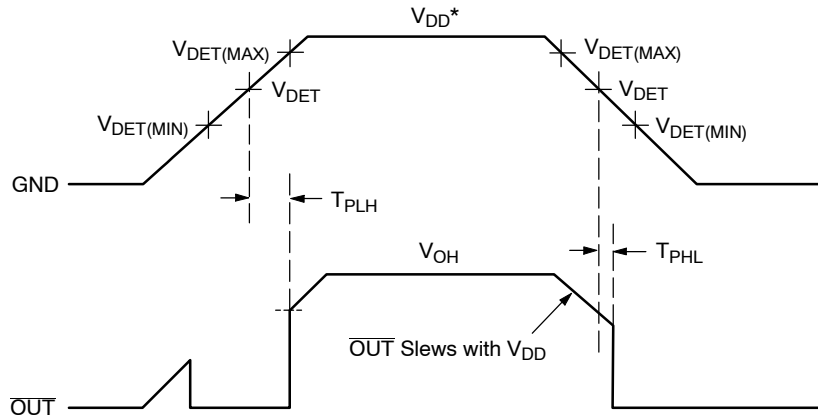

Figure 2. Block Diagram



* Voltage of V_{DD} below 1 volt will not be able to maintain low output.

Figure 3. Timing Diagram

Table 4. PIN FUNCTIONS

Pin	Function
V_{DD}	Voltage Input and Power Supply
GND	Ground Pin
OUT	Active Low Open Drain output
NC	No Connect, the pin is electrically open

CAT808

TYPICAL ELECTRICAL OPERATING CHARACTERISTICS (Typical values at $T_A = 25^\circ\text{C}$)

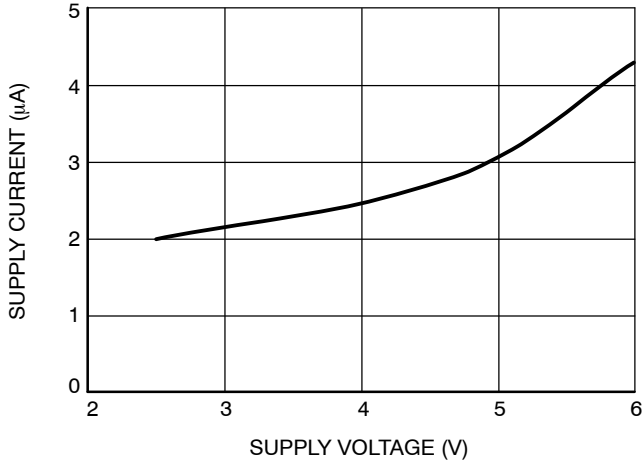

Figure 4. V_{DD} Supply Current vs. V_{DD} Supply Voltage

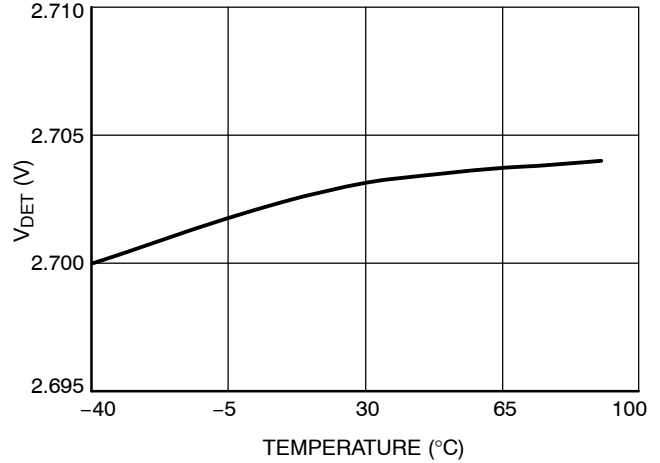

Figure 5. V_{DET} Detection Voltage vs. Temperature

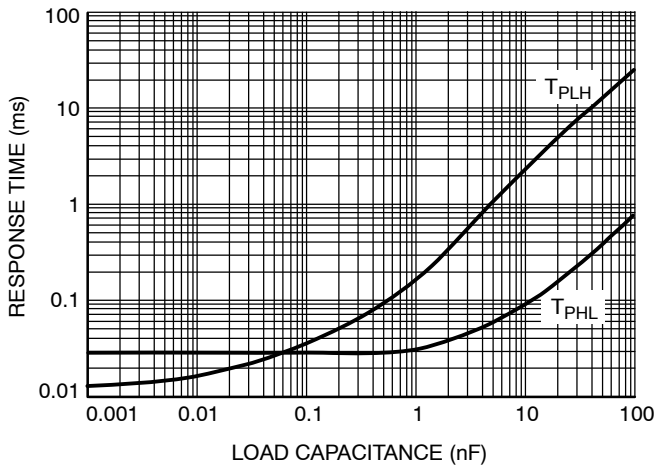

Figure 6. Response Time vs. Load Capacitance

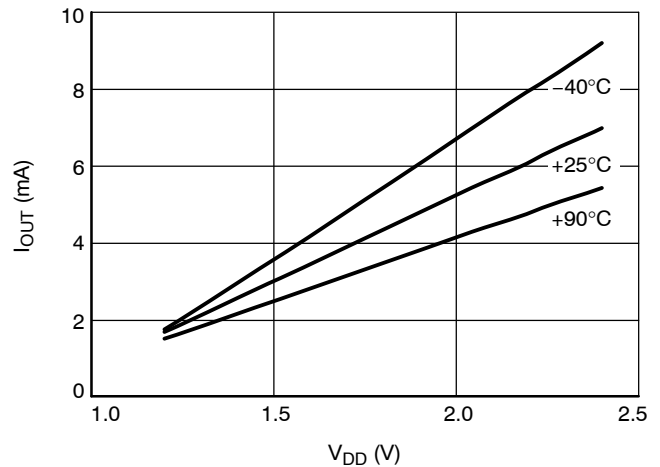
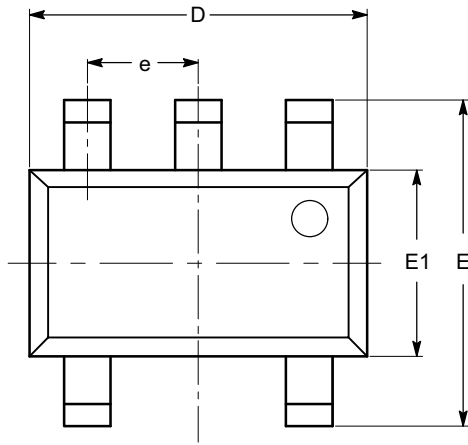

Figure 7. I_{OUT} Transistor Output Current vs. V_{DD} Supply Voltage

CAT808

PACKAGE DIMENSIONS

TSOT-23, 5 LEAD
CASE 419AE-01
ISSUE O



TOP VIEW

SYMBOL	MIN	NOM	MAX
A			1.00
A1	0.01	0.05	0.10
A2	0.80	0.87	0.90
b	0.30		0.45
c	0.12	0.15	0.20
D	2.90 BSC		
E	2.80 BSC		
E1	1.60 BSC		
e	0.95 TYP		
L	0.30	0.40	0.50
L1	0.60 REF		
L2	0.25 BSC		
θ	0°		8°

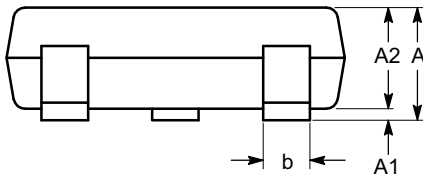

SIDE VIEW

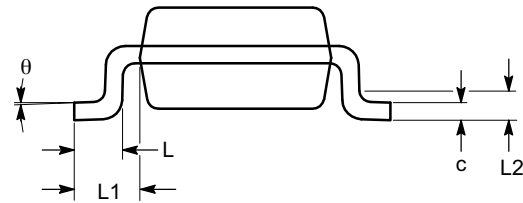

END VIEW

Notes:

- (1) All dimensions are in millimeters. Angles in degrees.
- (2) Complies with JEDEC MO-193.

CAT808

Ordering Information

Table 5. ORDERING INFORMATION

Orderable Part Number	Specific Device Marking	Package	Temperature Range	Lead Finish	Shipping†
CAT808NTDI-25GT3	TL	TSOT-23-5	Industrial	NiPdAu	3000 Units / Tape & Reel
CAT808NTDI-27GT3	TL	TSOT-23-5	Industrial	NiPdAu	3000 Units / Tape & Reel
CAT808NTDI-32GT3	TL	TSOT-23-5	Industrial	NiPdAu	3000 Units / Tape & Reel
CAT808NTDI-35GT3	TL	TSOT-23-5	Industrial	NiPdAu	3000 Units / Tape & Reel

†For information on tape and reel specifications, including part orientation and tape sizes, please refer to our Tape and Reel Packaging Specification Brochure, BRD8011/D.

ON Semiconductor and **ON** are registered trademarks of Semiconductor Components Industries, LLC (SCILLC). SCILLC reserves the right to make changes without further notice to any products herein. SCILLC makes no warranty, representation or guarantee regarding the suitability of its products for any particular purpose, nor does SCILLC assume any liability arising out of the application or use of any product or circuit, and specifically disclaims any and all liability, including without limitation special, consequential or incidental damages. "Typical" parameters which may be provided in SCILLC data sheets and/or specifications can and do vary in different applications and actual performance may vary over time. All operating parameters, including "Typicals" must be validated for each customer application by customer's technical experts. SCILLC does not convey any license under its patent rights nor the rights of others. SCILLC products are not designed, intended, or authorized for use as components in systems intended for surgical implant into the body, or other applications intended to support or sustain life, or for any other application in which the failure of the SCILLC product could create a situation where personal injury or death may occur. Should Buyer purchase or use SCILLC products for any such unintended or unauthorized application, Buyer shall indemnify and hold SCILLC and its officers, employees, subsidiaries, affiliates, and distributors harmless against all claims, costs, damages, and expenses, and reasonable attorney fees arising out of, directly or indirectly, any claim of personal injury or death associated with such unintended or unauthorized use, even if such claim alleges that SCILLC was negligent regarding the design or manufacture of the part. SCILLC is an Equal Opportunity/Affirmative Action Employer. This literature is subject to all applicable copyright laws and is not for resale in any manner.

PUBLICATION ORDERING INFORMATION

LITERATURE FULFILLMENT:

Literature Distribution Center for ON Semiconductor
P.O. Box 5163, Denver, Colorado 80217 USA
Phone: 303-675-2175 or 800-344-3860 Toll Free USA/Canada
Fax: 303-675-2176 or 800-344-3867 Toll Free USA/Canada
Email: orderlit@onsemi.com

N. American Technical Support: 800-282-9855 Toll Free
USA/Canada
Europe, Middle East and Africa Technical Support:
Phone: 421 33 790 2910
Japan Customer Focus Center
Phone: 81-3-5773-3850

ON Semiconductor Website: www.onsemi.com

Order Literature: <http://www.onsemi.com/orderlit>

For additional information, please contact your local Sales Representative

www.BDTIC.com/ON/

CAT808/D