

CAT8836

NanoPower Supervisory Circuit

Description

The CAT8836 is a voltage supervisory circuit intended to provide circuit initialization and start-up timing for DSPs and other processor-based systems.

When system power comes on, CAT8836's output goes active once the supply voltage V_{DD} becomes higher than 1.1 V. Thereafter, the supervisory circuit monitors V_{DD} and keeps the output active as long as V_{DD} remains below the threshold voltage of V_{TH} . After V_{DD} exceeds the monitoring threshold an internal timer delays the return of the output to the inactive state (high) to ensure proper system reset.

The duration of this reset delay is controlled by the CT input. When CT is connected to GND the reset delay is 10 ms, typical, in duration and when connected to V_{DD} , the delay time is typically 200 ms. Whenever the supply voltage drops below the monitoring threshold voltage V_{TH} , the output becomes active (low) again.

Features

- Supply Current: 220 nA (typical)
- Precision Supply Voltage Supervision Range: 1.8 V, 2.5 V, 3.0 V, and 3.3 V
- Power-On Reset Generator with Selectable Delay Time: 10 ms or 200 ms
- Push/Pull $\overline{\text{RESET}}$ (active low) Output
- Manual Reset Input
- Pin-for-Pin Replacement for TPS3836
- TSOT23-5 Package
- Temperature Range: -40°C to $+85^{\circ}\text{C}$
- These Devices are Pb-Free, Halogen Free/BFR Free and are RoHS Compliant

Typical Applications

- Applications Using Low-Power DSPs, Microcontrollers, or Microprocessors
- Portable- and Battery-Powered Equipment
- Intelligent Instruments
- Wireless Communication Systems
- Automotive Systems
- Notebook Computers



ON Semiconductor®

<http://onsemi.com>



TSOT-23
TD SUFFIX
CASE 419AE

PIN CONNECTIONS

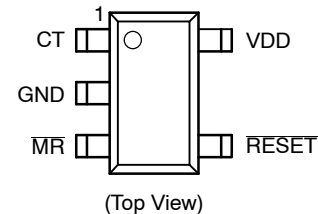

MARKING DIAGRAM

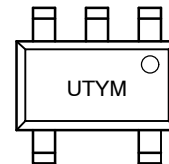

UT = Device Code
Y = Production Year (Last Digit)
M = Production Month: 1-9 (Jan - Sep),
O, N, D (Oct - Dec)

ORDERING INFORMATION

See detailed ordering and shipping information in the package dimensions section on page 7 of this data sheet.

CAT8836

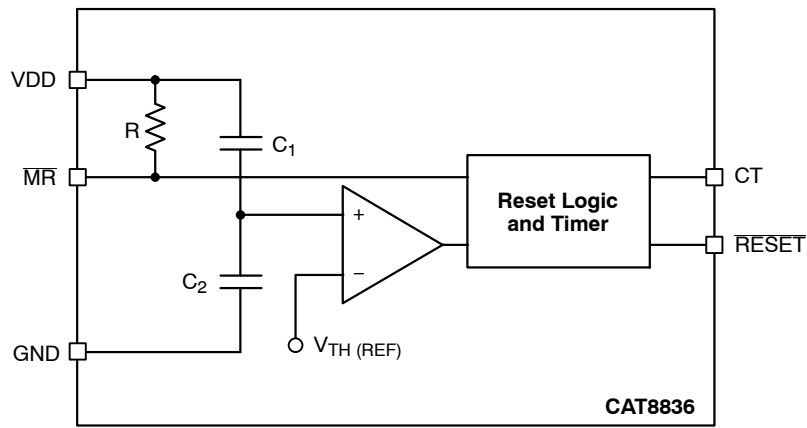

Figure 1. Functional Block Diagram

Table 1. PIN FUNCTION DESCRIPTION

Pin Number	Pin Name	Description
1	CT	Delay select pin for a fixed value of 10 ms or 200 ms.
2	GND	Ground
3	$\overline{\text{MR}}$	Manual Reset
4	$\overline{\text{RESET}}$	Active low Reset. Reset is asserted either if VDD falls below reset threshold or if MR is activated.
5	VDD	Supply Voltage which is monitored

Table 2. ABSOLUTE MAXIMUM RATINGS (Over operating free-air temperature range, unless otherwise noted.)

Parameter	Symbol	Value	Unit
Supply voltage (Note 1)	V_{DD}	7	V
All other pins (Note 1)		-0.3 to 6	V
Maximum low output current	I_{OL}	5	mA
Maximum high output current	I_{OH}	-5	mA
Input clamp current, ($V_I < 0$ or $V_I > V_{DD}$)	I_{IK}	± 10	mA
Output clamp current, ($V_O < 0$ or $V_O > V_{DD}$)	I_{OK}	± 10	mA
Storage temperature range	T_{STG}	-65 to +150	$^{\circ}\text{C}$
Soldering temperature		+260	$^{\circ}\text{C}$

Stresses exceeding Maximum Ratings may damage the device. Maximum Ratings are stress ratings only. Functional operation above the Recommended Operating Conditions is not implied. Extended exposure to stresses above the Recommended Operating Conditions may affect device reliability.

1. All voltages are with respect to GND.

Table 3. RECOMMENDED OPERATING CONDITIONS (Note 2)

Parameter	Symbol	Min	Max	Unit
Supply voltage	V_{DD}	1.6	5.5	V
Voltage range, CT, $\overline{\text{MR}}$ and $\overline{\text{RESET}}$ pins		0	$V_{DD} + 0.3$	V
High-level input voltage	V_{IH}	$0.7 \times V_{DD}$		V
Low-level input voltage	V_{IL}		$0.3 \times V_{DD}$	V
Input transition rise and fall rate at $\overline{\text{MR}}$	$\Delta t/\Delta V$		100	ns/V
Operating temperature range	T_A	-40	+85	$^{\circ}\text{C}$

2. Refer to Electrical Characteristics and Application Information for Safe Operating Area.

CAT8836

Table 4. ELECTRICAL CHARACTERISTICS (Over recommended operating conditions, unless otherwise noted.)

Parameter		Symbol	Test Conditions	Min	Typ	Max	Unit
RESET high-level output voltage		V_{OH}	$V_{DD} = 3.3\text{ V}, I_{OH} = -2\text{ mA}$	$0.8 \times V_{DD}$			V
RESET Low-level output voltage		V_{OL}	$V_{DD} = 1.8\text{ V}, I_{OL} = 1\text{ mA}$			0.4	V
			$V_{DD} = 3.3\text{ V}, I_{OL} = 2\text{ mA}$				
RESET power-up voltage (Note 3)			$V_{DD} \geq 1.1\text{ V}, I_{OL} = 50\text{ }\mu\text{A}$			0.2	V
Negative-going input threshold voltage (Note 4)	CAT8836E18	V_{TH}	$T_A = -40^\circ\text{C to } +85^\circ\text{C}$	1.66	1.71	1.74	V
	CAT8836J25			2.18	2.25	2.29	V
	CAT8836H30			2.70	2.79	2.85	V
	CAT8836L30			2.56	2.64	2.69	V
	CAT8836K33			2.84	2.93	2.99	V
Hysteresis at V_{DD} input		V_{HYS}	$1.7\text{ V} < V_{IT} < 2.5\text{ V}$		30		mV
			$2.5\text{ V} < V_{IT} < 3.5\text{ V}$		40		
Input high-level current	MR (Note 5)	I_{IH}	MR = $0.7 \times V_{DD}$, $V_{DD} = 5.5\text{ V}$	-40	-60	-100	μA
	CT		CT = $V_{DD} = 5.5\text{ V}$	-25		+25	nA
Input low-level current	MR (Note 5)	I_{IL}	MR = 0 V, $V_{DD} = 5.5\text{ V}$	-130	-200	-340	μA
	CT		CT = 0 V, $V_{DD} = 5.5\text{ V}$	-25		+25	nA
Supply current		I_{DD}	$V_{DD} > V_{TH}, V_{DD} < 3\text{ V}$		220	400	nA
			$V_{DD} > V_{TH}, V_{DD} > 3\text{ V}$		250	450	
			$V_{DD} < V_{TH}$		10	15	μA
Internal pull-up resistor at MR		R_{IN}			30		k Ω
Input capacitance at MR and CT		C_I	$V_I = 0\text{ V to } V_{DD}$		5		pF

3. The lowest voltage at which the RESET output becomes active. $t_R, V_{DD} \geq 15\text{ }\mu\text{s/V}$.

4. To ensure best stability of the threshold voltage, a bypass capacitor (ceramic, 0.1 μF) should be placed near the supply terminal.

5. If manual reset is unused, MR should be connected to V_{DD} to minimize current consumption.

Table 5. SWITCHING CHARACTERISTICS (At $T_A = +25^\circ\text{C}$, $R_L = 1\text{ M}\Omega$, and $C_L = 50\text{ pF}$, unless otherwise noted.)

Parameter		Symbol	Test Conditions	Min	Typ	Max	Unit
Delay time		t_{PD}	$V_{DD} \geq V_{TH} + 0.2\text{ V},$ MR = $0.7 \times V_{DD}, \text{CT} = \text{GND}$	5	10	15	ms
			$V_{DD} \geq V_{TH} + 0.2\text{ V},$ MR = $0.7 \times V_{DD}, \text{CT} = V_{DD}$	100	200	300	
Propagation (delay) time, high-to-low-level output	V_{DD} to RESET delay	t_{PHL}	$V_{IL} = V_{TH} - 0.2\text{ V},$ $V_{IH} = V_{TH} + 0.2\text{ V}$			10	μs
			$V_{IL} = 1.6\text{ V}$			50	
Propagation (delay) time, high-to-low-level output	MR to RESET delay	t_{MHL}	$V_{DD} \geq V_{TH} + 0.2\text{ V},$ $V_{IL} = 0.3 \times V_{DD},$ $V_{IH} = 0.7 \times V_{DD}$			100	ns

Table 6. TIMING REQUIREMENTS (At $T_A = +25^\circ\text{C}$, $R_L = 1\text{ M}\Omega$, and $C_L = 50\text{ pF}$, unless otherwise noted.)

Parameter		Symbol	Test Conditions	Min	Typ	Max	Unit
Pulse width	at V_{DD}	t_W	$V_{IH} = V_{TH} + 0.2\text{ V}, V_{IL} = V_{TH} - 0.2\text{ V}$	6			μs
	at MR	t_{WR}	$V_{DD} \geq V_{TH} + 0.2\text{ V}, V_{IL} = 0.3 \times V_{DD}, V_{IH} = 0.7 \times V_{DD}$	1			

CAT8836

Table 7. FUNCTION TABLE

MR	$V_{DD} > V_{TH}$	RESET
L	0	L
L	1	L
H	0	L
H	1	H

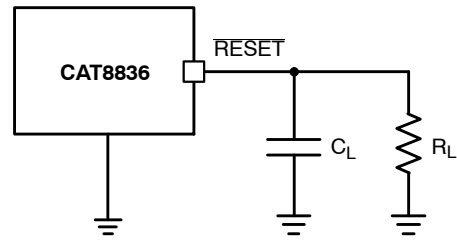

Figure 2. Test Circuit

TIMING DIAGRAM

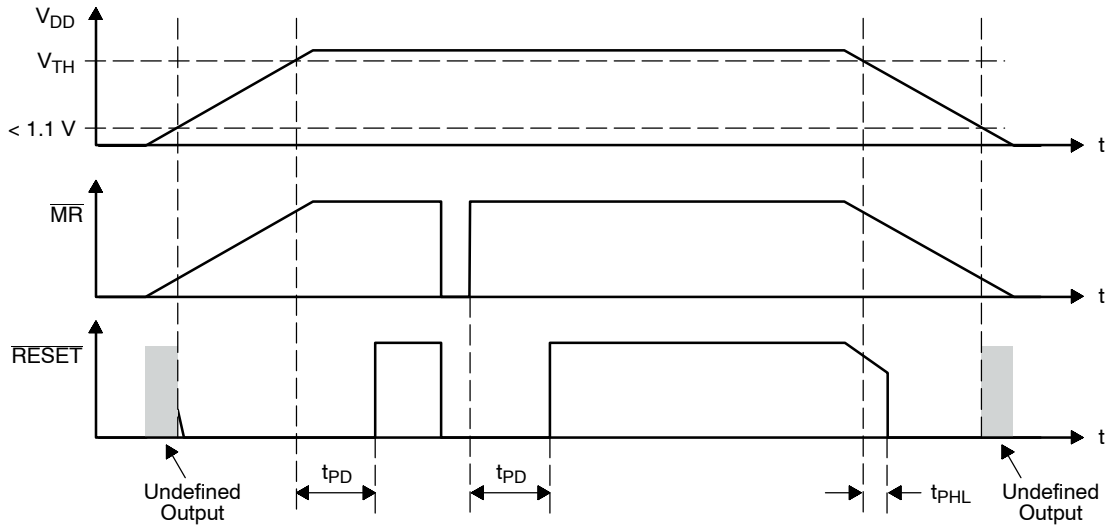

Figure 3. Timing Diagram

TYPICAL CHARACTERISTICS

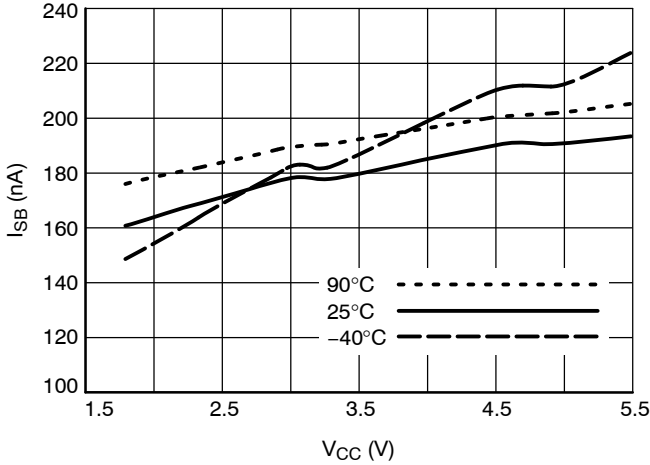

Figure 4. Supply Current vs. Supply Voltage

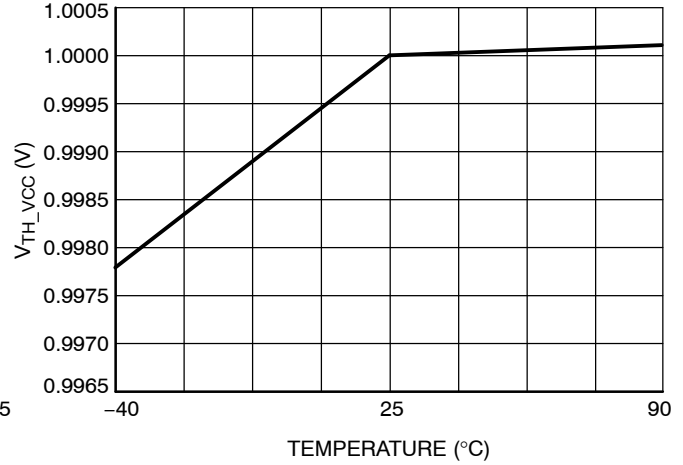

Figure 5. Normalized Reset Threshold Voltage vs. Temperature

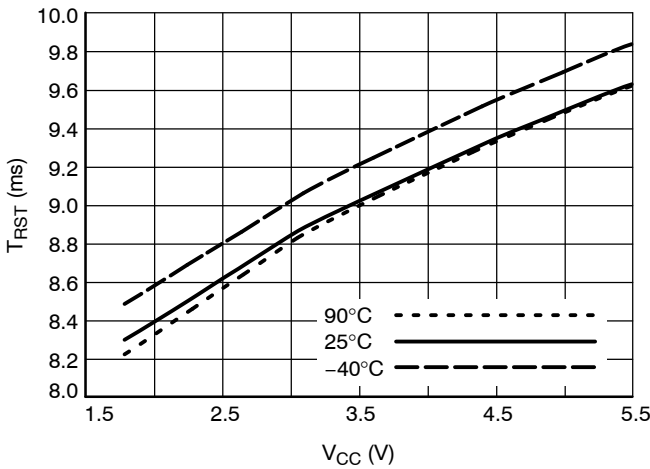

Figure 6. Reset Time Out vs. V_{CC} (CT = 0 V)

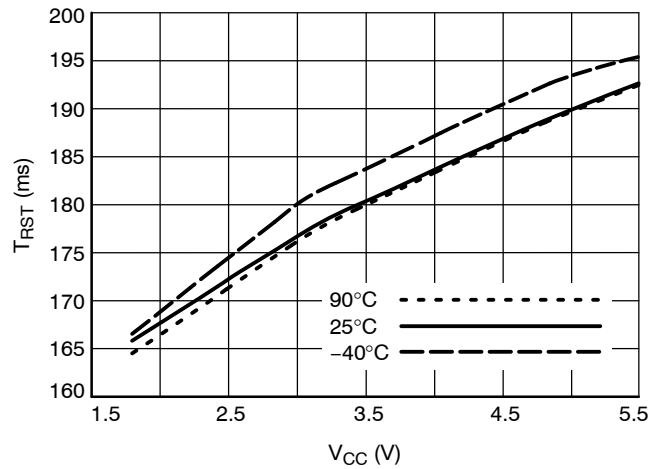

Figure 7. Reset Time Out vs. V_{CC} (CT = 5 V)

Detailed Description

The supervisory circuit monitors V_{DD} and keeps the $\overline{\text{RESET}}$ output active as long as V_{DD} remains below the threshold voltage of V_{TH} . An internal timer delays the return

of the output to the inactive state (high) to ensure proper system reset. The delay time starts after V_{DD} has risen above the threshold.

CAT8836

PACKAGE DIMENSIONS

TSOT-23, 5 LEAD
CASE 419AE-01
ISSUE O

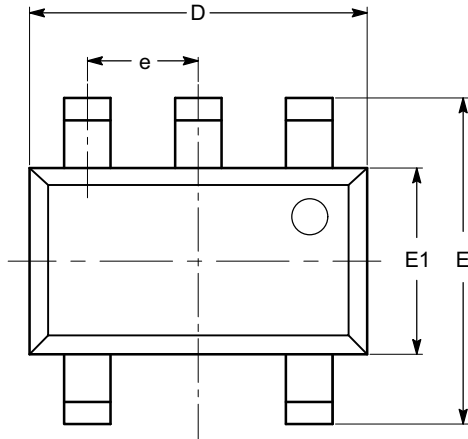

TOP VIEW

SYMBOL	MIN	NOM	MAX
A			1.00
A1	0.01	0.05	0.10
A2	0.80	0.87	0.90
b	0.30		0.45
c	0.12	0.15	0.20
D	2.90 BSC		
E	2.80 BSC		
E1	1.60 BSC		
e	0.95 TYP		
L	0.30	0.40	0.50
L1	0.60 REF		
L2	0.25 BSC		
θ	0°		8°

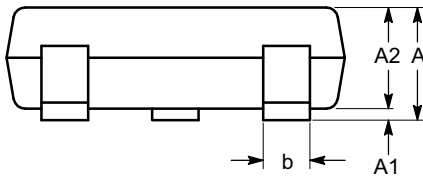

SIDE VIEW

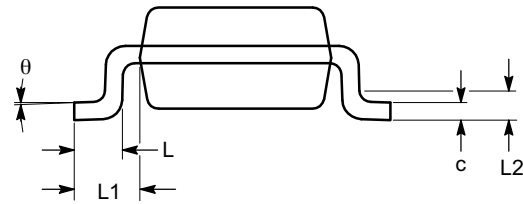

END VIEW

Notes:

- (1) All dimensions are in millimeters. Angles in degrees.
- (2) Complies with JEDEC MO-193.

CAT8836

Table 8. ORDERING INFORMATION

Device	Nominal Supply Voltage	Threshold Level	Marking	Package	Shipping
CAT8836E18TD-GT3	1.8 V	1.71	UTYM	TSOT-23 (Pb-Free)	3000 / Tape & Reel
CAT8836J25TD-GT3	2.5 V	2.25			
CAT8836H30TD-GT3	3.0 V	2.79			
CAT8836L30TD-GT3	3.0 V	2.64			
CAT8836K33TD-GT3	3.3 V	2.93			

Example of Ordering Information (Notes 6 – 9)

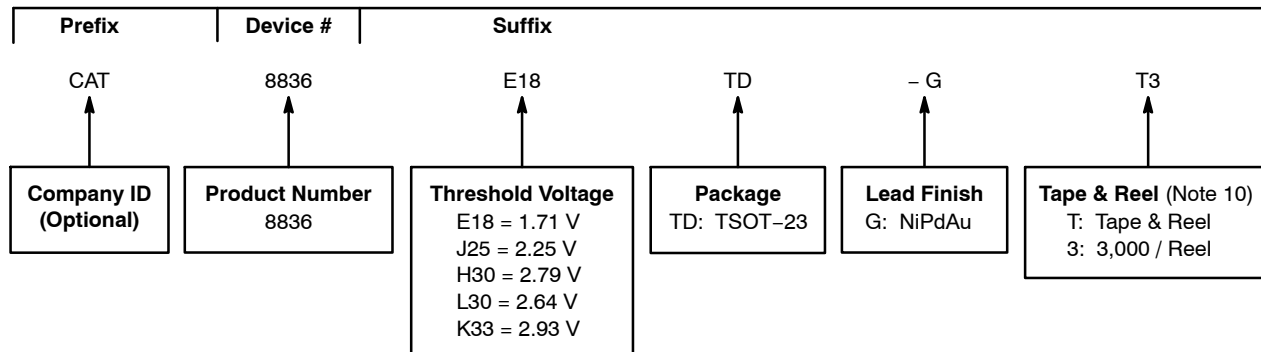

6. All packages are RoHS-compliant (Lead-free, Halogen-free).
7. The standard finish is NiPdAu.
8. The device used in the above example is a CAT8836E18TD-GT3 (CAT8836, 1.71 threshold voltage, TSOT-23, NiPdAu, Tape & Reel, 3,000/Reel).
9. For additional detection voltage, package and temperature options, please contact your nearest ON Semiconductor Sales office.
10. For information on tape and reel specifications, including part orientation and tape sizes, please refer to our Tape and Reel Packaging Specifications Brochure, BRD8011/D.

ON Semiconductor and  are registered trademarks of Semiconductor Components Industries, LLC (SCILLC). SCILLC reserves the right to make changes without further notice to any products herein. SCILLC makes no warranty, representation or guarantee regarding the suitability of its products for any particular purpose, nor does SCILLC assume any liability arising out of the application or use of any product or circuit, and specifically disclaims any and all liability, including without limitation special, consequential or incidental damages. "Typical" parameters which may be provided in SCILLC data sheets and/or specifications can and do vary in different applications and actual performance may vary over time. All operating parameters, including "Typicals" must be validated for each customer application by customer's technical experts. SCILLC does not convey any license under its patent rights nor the rights of others. SCILLC products are not designed, intended, or authorized for use as components in systems intended for surgical implant into the body, or other applications intended to support or sustain life, or for any other application in which the failure of the SCILLC product could create a situation where personal injury or death may occur. Should Buyer purchase or use SCILLC products for any such unintended or unauthorized application, Buyer shall indemnify and hold SCILLC and its officers, employees, subsidiaries, affiliates, and distributors harmless against all claims, costs, damages, and expenses, and reasonable attorney fees arising out of, directly or indirectly, any claim of personal injury or death associated with such unintended or unauthorized use, even if such claim alleges that SCILLC was negligent regarding the design or manufacture of the part. SCILLC is an Equal Opportunity/Affirmative Action Employer. This literature is subject to all applicable copyright laws and is not for resale in any manner.

PUBLICATION ORDERING INFORMATION

LITERATURE FULFILLMENT:
Literature Distribution Center for ON Semiconductor
P.O. Box 5163, Denver, Colorado 80217 USA
Phone: 303-675-2175 or 800-344-3860 Toll Free USA/Canada
Fax: 303-675-2176 or 800-344-3867 Toll Free USA/Canada
Email: orderlit@onsemi.com

N. American Technical Support: 800-282-9855 Toll Free
USA/Canada
Europe, Middle East and Africa Technical Support:
Phone: 421 33 790 2910
Japan Customer Focus Center
Phone: 81-3-5773-3850

ON Semiconductor Website: www.onsemi.com
Order Literature: <http://www.onsemi.com/orderlit>
For additional information, please contact your local Sales Representative