

CM1216

6 and 8-Channel Low Capacitance ESD Arrays

Product Description

The CM1216 family of diode arrays provide sESD protection for electronic components or sub-systems requiring minimal capacitive loading. These devices are ideal for protecting systems with high data and clock rates or for circuits requiring low capacitive loading. Each ESD channel consists of a pair of diodes in series which steer the positive or negative ESD current pulse to either the positive (V_P) or negative (V_N) supply rail. The CM1216 protects against ESD pulses up to ± 15 kV per the IEC 61000-4-2 standard.

This device is particularly well-suited for protecting systems using high-speed ports such as USB2.0, IEEE1394 (Firewire[®], iLink[™]), Serial ATA, DVI, HDMI and corresponding ports in removable storage, digital camcorders, DVD-RW drives and other applications where extremely low loading capacitance with ESD protection are required in a small package footprint.

Features

- Six and Eight Channels of ESD Protection
- Provides ± 15 kV ESD Protection on Each Channel per the IEC 61000-4-2 ESD Requirements
- Channel Loading Capacitance of 1.6 pF Typical
- Channel I/O to GND Capacitance Difference of 0.04 pF Typical
- Mutual Capacitance of 0.13 pF Typical
- Minimal Capacitance Change with Temperature and Voltage
- Each I/O Pin Can Withstand Over 1000 ESD Strikes
- SOIC and MSOP Packages
- These Devices are Pb-Free and are RoHS Compliant

Applications

- IEEE1394 Firewire[®] Ports at 400 Mbps / 800 Mbps
- DVI Ports, HDMI Ports in Notebooks, Set Top Boxes, Digital TVs, LCD Displays
- Serial ATA Ports in Desktop PCs and Hard Disk Drives
- PCI Express Ports
- General Purpose High-Speed Data Line ESD Protection



ON Semiconductor[®]

<http://onsemi.com>

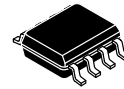

SOIC-8
SM SUFFIX
CASE 751AC

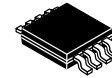

MSOP-8
MR SUFFIX
CASE 846AD

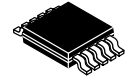

MSOP-10
MR SUFFIX
CASE 846AE

BLOCK DIAGRAM

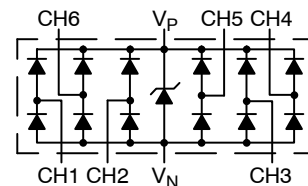

CM1216-06SM
CM1216-06MR

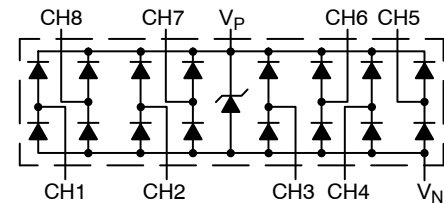

CM1216-08MR

MARKING DIAGRAM

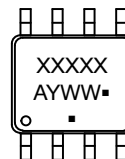

XXXXXX = Specific Device Code
A = Assembly Location
Y = Year
WW = Work Week
▪ = Pb-Free Package

ORDERING INFORMATION

Device	Package	Shipping [†]
CM1216-06SM	SOIC (Pb-Free)	2500/Tape & Reel
CM1216-06MR	MSOP (Pb-Free)	4000/Tape & Reel
CM1216-08MR	MSOP (Pb-Free)	4000/Tape & Reel

[†]For information on tape and reel specifications, including part orientation and tape sizes, please refer to our Tape and Reel Packaging Specification Brochure, BRD8011/D.

CM1216

PACKAGE / PINOUT DIAGRAMS

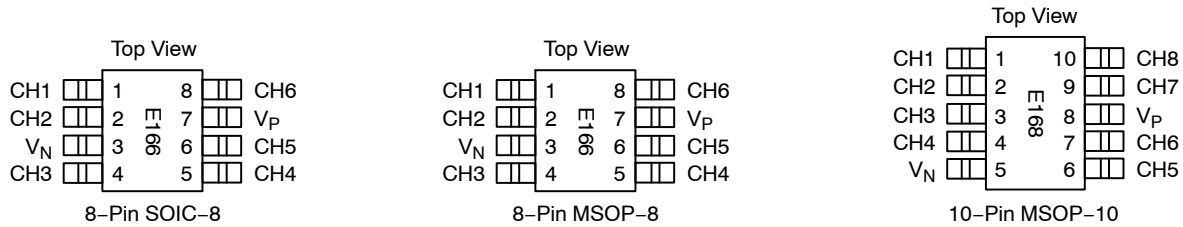

Table 1. PIN DESCRIPTIONS

Pin Name	MSOP-8	SOIC-8	MSOP-10	Type	Description
	Pin No.	Pin No.	Pin No.		
CH1	1	1	1	I/O	ESD Channel
CH2	2	2	2	I/O	ESD Channel
CH3	4	4	3	I/O	ESD Channel
CH4	5	5	4	I/O	ESD Channel
V _N	3	3	5	GND	Negative voltage supply rail
CH5	6	6	6	I/O	ESD Channel
CH6	8	8	7	I/O	ESD Channel
V _P	7	7	8	PWR	Positive voltage supply rail
CH7	-	-	9	I/O	ESD Channel
CH8	-	-	10	I/O	ESD Channel

SPECIFICATIONS

Table 2. ABSOLUTE MAXIMUM RATINGS

Parameter	Rating	Units
Operating Supply Voltage (V _P -V _N)	6	V
Diode Forward DC Current	20	μA
DC Voltage at any Channel Input	(V _N -0.5) to (V _P +0.5)	V
Operating Temperature Range Ambient Junction	-40 to +85 -40 to +125	°C
Storage Temperature Range	-40 to +150	°C

Stresses exceeding Maximum Ratings may damage the device. Maximum Ratings are stress ratings only. Functional operation above the Recommended Operating Conditions is not implied. Extended exposure to stresses above the Recommended Operating Conditions may affect device reliability.

Table 3. STANDARD OPERATING CONDITIONS

Parameter	Rating	Units
Temperature Range (Ambient)	-40 to +85	°C
Package Power Rating MSOP8 Package (CM1216-06MR) SOIC8 Package (CM1216-06SM) MSOP10 Package (CM1216-08MR)	400 600 400	mW

CM1216

Table 4. ELECTRICAL OPERATING CHARACTERISTICS (Note 1)

Symbol	Parameter	Conditions	Min	Typ	Max	Units
V_P	Operating Supply Voltage ($V_P - V_N$)			3.3	5.5	V
I_P	Operating Supply Current	$(V_P - V_N) = 3.3\text{ V}$			8	μA
V_F	Diode Forward Voltage Top Diode Bottom Diode	$I_F = 20\ \mu\text{A}; T_A = 25^\circ\text{C}$	0.6 0.6	0.8 0.8	0.95 0.95	V
I_{LEAK}	Channel Leakage Current	$T_A = 25^\circ\text{C}; V_P = 5\text{ V}, V_N = 0\text{ V}$		± 0.1	± 1.0	μA
C_{IN}	Channel Input Capacitance	At 1 MHz, $V_P = 3.3\text{ V}, V_N = 0\text{ V}, V_{IN} = 1.65\text{ V}$ (Note 2)		1.6	2.0	pF
ΔC_{IN}	Channel Input Capacitance Matching			0.04		pF
C_{MUTUAL}	Mutual Capacitance	$(V_P - V_N) = 3.3\text{ V}$		0.13		pF
V_{ESD}	ESD Protection Peak Discharge Voltage at any channel input, in system, contact discharge per IEC 61000-4-2 standard	$T_A = 25^\circ\text{C}$ (Notes 2 and 3)	± 15			kV
V_{CL}	Channel Clamp Voltage Positive Transients Negative Transients	$I_{PP} = 1\text{ A}, t_P = 8/20\ \mu\text{s}; T_A = 25^\circ\text{C}$		+9.0 -1.5		V
R_{DYN}	Dynamic Resistance Positive transients Negative transients	$I_{PP} = 1\text{ A}, t_P = 8/20\ \mu\text{s}; T_A = 25^\circ\text{C}$		0.6 0.4		Ω

1. All parameters specified at $T_A = -40^\circ\text{C}$ to $+85^\circ\text{C}$ unless otherwise noted.
2. Standard IEC 61000-4-2 with $C_{Discharge} = 150\text{ pF}$, $R_{Discharge} = 330\ \Omega$, $V_P = 3.3\text{ V}$, V_N grounded.
3. From I/O pins to V_P or V_N only. V_P bypassed to V_N with low ESR $0.2\ \mu\text{F}$ ceramic capacitor.

PERFORMANCE CHARACTERISTICS

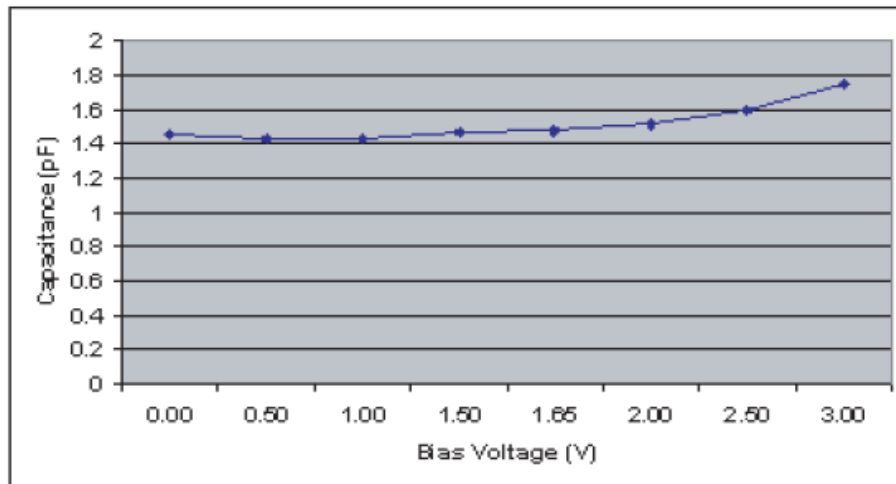

Figure 1. Typical Variation of C_{IN} vs. V_{IN}
($f = 1\text{ MHz}, V_P = 3.3\text{ V}, V_N = 0\text{ V}, 0.1\ \mu\text{F}$ Chip Capacitor between V_P and $V_N, T_A = 25^\circ\text{C}$)

APPLICATION INFORMATION

Design Considerations

In order to realize the maximum protection against ESD pulses, care must be taken in the PCB layout to minimize parasitic series inductances on the Supply/Ground rails as well as the signal trace segment between the signal input (typically a connector) and the ESD protection device. Refer to Application of Positive ESD Pulse between Input Channel and Ground, which illustrates an example of a positive ESD pulse striking an input channel. The parasitic series inductance back to the power supply is represented by L_1 and L_2 . The voltage V_{CL} on the line being protected is:

$$V_{CL} = \text{Fwd voltage drop of } D_1 + V_{SUPPLY} + L_1 \times d(I_{ESD}) / dt + L_2 \times d(I_{ESD}) / dt$$

where I_{ESD} is the ESD current pulse, and V_{SUPPLY} is the positive supply voltage.

An ESD current pulse can rise from zero to its peak value in a very short time. As an example, a level 4 contact discharge per the IEC61000-4-2 standard results in a current pulse that rises from zero to 30 Amps in 1 ns. Here $d(I_{ESD})/dt$ can be approximated by $\Delta I_{ESD}/\Delta t$, or $30/(1 \times 10^{-9})$. So just 10 nH of series inductance (L_1 and L_2 combined) will lead to a 300 V increment in V_{CL} !

Similarly for negative ESD pulses, parasitic series inductance from the V_N pin to the ground rail will lead to drastically increased negative voltage on the line being protected.

The CM1213 has an integrated Zener diode between V_P and V_N . This greatly reduces the effect of supply rail inductance L_2 on V_{CL} by clamping V_P at the breakdown voltage of the Zener diode. However, for the lowest possible V_{CL} , especially when V_P is biased at a voltage significantly below the Zener breakdown voltage, it is recommended that a 0.22 μF ceramic chip capacitor be connected between V_P and the ground plane.

As a general rule, the ESD Protection Array should be located as close as possible to the point of entry of expected electrostatic discharges. The power supply bypass capacitor mentioned above should be as close to the V_P pin of the Protection Array as possible, with minimum PCB trace lengths to the power supply, ground planes and between the signal input and the ESD device to minimize stray series inductance.

Additional Information

See also ON Semiconductor Application Note, "Design Considerations for ESD Protection", in the Applications section.

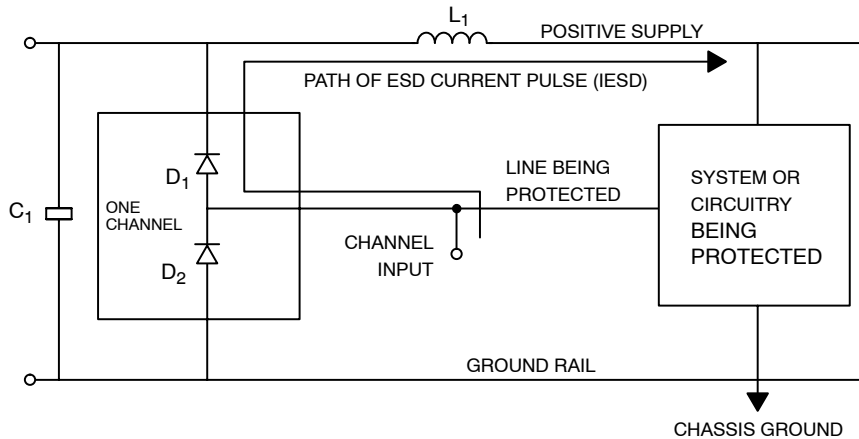
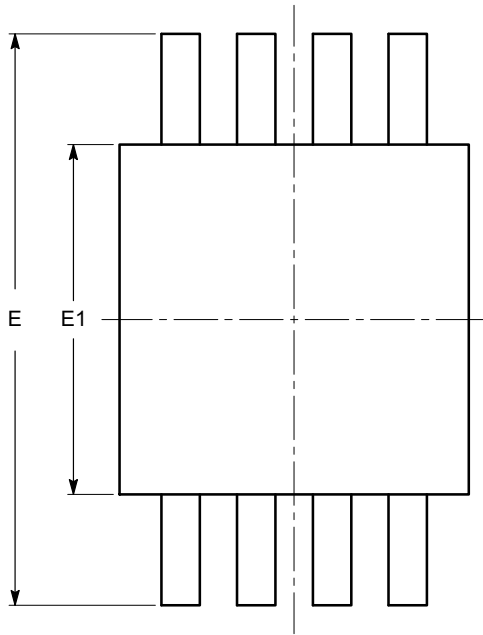

Figure 2. Application of Positive ESD Pulse between Input Channel and Ground

CM1216

PACKAGE DIMENSIONS

MSOP 8, 3x3
CASE 846AD-01
ISSUE O



TOP VIEW

SYMBOL	MIN	NOM	MAX
A			1.10
A1	0.05	0.10	0.15
A2	0.75	0.85	0.95
b	0.22		0.38
c	0.13		0.23
D	2.90	3.00	3.10
E	4.80	4.90	5.00
E1	2.90	3.00	3.10
e	0.65 BSC		
L	0.40	0.60	0.80
L1	0.95 REF		
L2	0.25 BSC		
θ	0°		6°

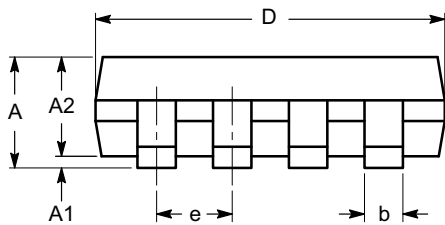

SIDE VIEW

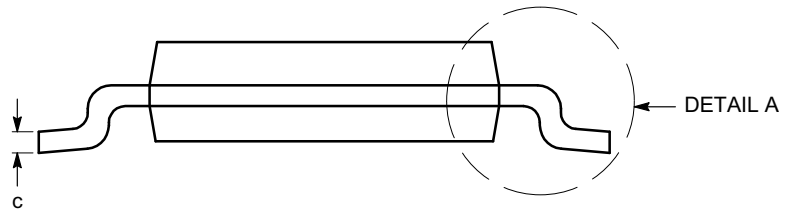

END VIEW

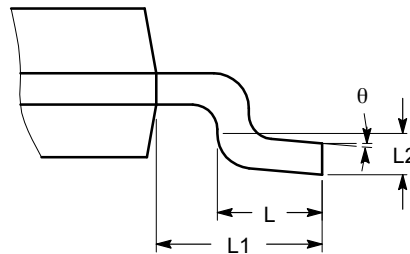

DETAIL A

Notes:

- (1) All dimensions are in millimeters. Angles in degrees.
- (2) Complies with JEDEC MO-187.

CM1216

PACKAGE DIMENSIONS

MSOP 10, 3x3
CASE 846AE-01
ISSUE O

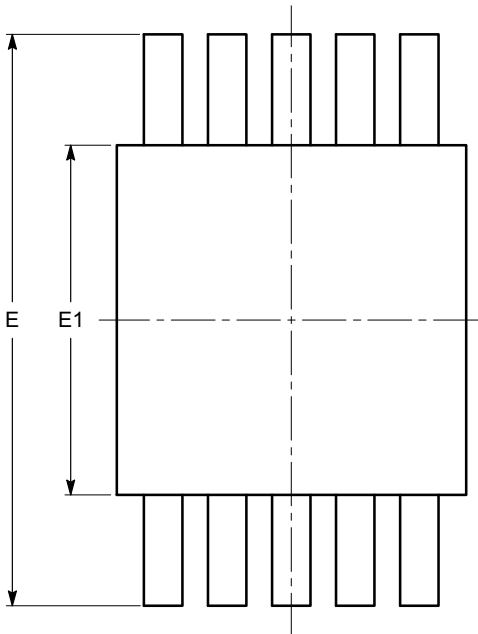

TOP VIEW

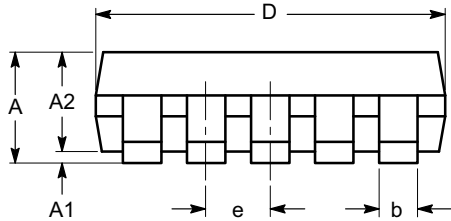

SIDE VIEW

SYMBOL	MIN	NOM	MAX
A			1.10
A1	0.00	0.05	0.15
A2	0.75	0.85	0.95
b	0.17		0.27
c	0.13		0.23
D	2.90	3.00	3.10
E	4.75	4.90	5.05
E1	2.90	3.00	3.10
e	0.50 BSC		
L	0.40	0.60	0.80
L1	0.95 REF		
L2	0.25 BSC		
θ	0°		8°

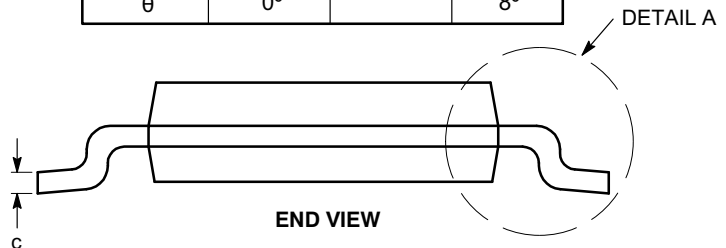

END VIEW

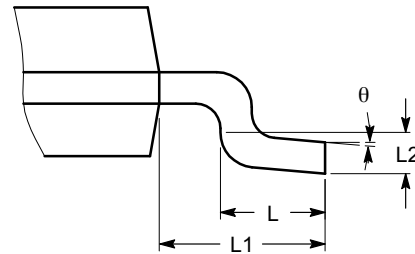

DETAIL A

Notes:

- (1) All dimensions are in millimeters. Angles in degrees.
- (2) Complies with JEDEC MO-187.

FireWire is a registered trademark of Apple Computer, Inc.
iLink is a trademark of S. J. Electro Systems, Inc.

ON Semiconductor and are registered trademarks of Semiconductor Components Industries, LLC (SCILLC). SCILLC reserves the right to make changes without further notice to any products herein. SCILLC makes no warranty, representation or guarantee regarding the suitability of its products for any particular purpose, nor does SCILLC assume any liability arising out of the application or use of any product or circuit, and specifically disclaims any and all liability, including without limitation special, consequential or incidental damages. "Typical" parameters which may be provided in SCILLC data sheets and/or specifications can and do vary in different applications and actual performance may vary over time. All operating parameters, including "Typicals" must be validated for each customer application by customer's technical experts. SCILLC does not convey any license under its patent rights nor the rights of others. SCILLC products are not designed, intended, or authorized for use as components in systems intended for surgical implant into the body, or other applications intended to support or sustain life, or for any other application in which the failure of the SCILLC product could create a situation where personal injury or death may occur. Should Buyer purchase or use SCILLC products for any such unintended or unauthorized application, Buyer shall indemnify and hold SCILLC and its officers, employees, subsidiaries, affiliates, and distributors harmless against all claims, costs, damages, and expenses, and reasonable attorney fees arising out of, directly or indirectly, any claim of personal injury or death associated with such unintended or unauthorized use, even if such claim alleges that SCILLC was negligent regarding the design or manufacture of the part. SCILLC is an Equal Opportunity/Affirmative Action Employer. This literature is subject to all applicable copyright laws and is not for resale in any manner.

PUBLICATION ORDERING INFORMATION

LITERATURE FULFILLMENT:
Literature Distribution Center for ON Semiconductor
P.O. Box 5163, Denver, Colorado 80217 USA
Phone: 303-675-2175 or 800-344-3860 Toll Free USA/Canada
Fax: 303-675-2176 or 800-344-3867 Toll Free USA/Canada
Email: orderlit@onsemi.com

N. American Technical Support: 800-282-9855 Toll Free
USA/Canada
Europe, Middle East and Africa Technical Support:
Phone: 421 33 790 2910
Japan Customer Focus Center
Phone: 81-3-5773-3850

ON Semiconductor Website: www.onsemi.com
Order Literature: <http://www.onsemi.com/orderlit>
For additional information, please contact your local Sales Representative