

CM1234

PicoGuard[®] XS ESD Clamp Array for High Speed Data Line Protection

Product Description

The *PicoGuard XS* (Xtreme Speed) protection family is specifically designed for next generation deep sub-micron high speed data line protection.

The CM1234 is ideal for protecting systems with high data and clock rates or for circuits requiring low capacitive loading and tightly controlled signal skews (with channel-to-channel matching at 2% max deviation).

The device is particularly well-suited for protecting systems using high-speed ports such as DVI or HDMI, along with corresponding ports in removable storage, digital camcorders, DVD-RW drives and other applications where extremely low loading capacitance with ESD protection are required.

The CM1234 also features easily routed “pass-through” pinouts in a RoHS compliant (lead-free), 16-lead WDFN, small footprint package.

Features

- ESD Protection for 4 Pairs of Differential Channels
- ESD Protection to IEC61000-4-2 Level 4
 - ±15 kV Contact Discharge
 - ±20 kV Air Discharge
- Pass-through Impedance Matched Clamp Architecture
- Flow-through Routing for High-speed Signal Integrity
- Minimal Line Capacitance Change with Temperature and Voltage
- 100 Ω Matched Impedance for Each Paired Differential Channel
- Each I/O Pin can Withstand Over 1000 ESD Strikes*
- RoHS Compliant (lead-free) WDFN-16 Package

Applications

- DVI Ports, HDMI Ports in Notebooks, Set Top Boxes, Digital TVs, and LCD Displays
- General Purpose High-speed Data Line ESD Protection

*Standard test condition is IEC61000-4-2 level 4 test circuit with each pin subjected to ±8 kV contact discharge for 1000 pulses. Discharges are timed at 1 second intervals and all 1000 strikes are completed in one continuous test run. The part is then subjected to standard production test to verify that all of the tested parameters are within spec after the 1000 strikes.



ON Semiconductor[®]

<http://onsemi.com>

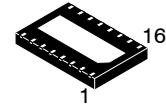

WDFN16
DE SUFFIX
CASE 511AY

PINOUT DIAGRAM

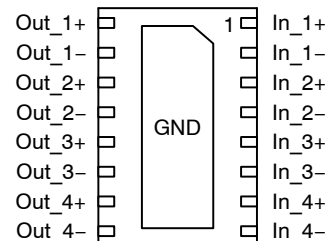

(Bottom View)

ORDERING INFORMATION

See detailed ordering and shipping information in the package dimensions section on page 8 of this data sheet.

CM1234

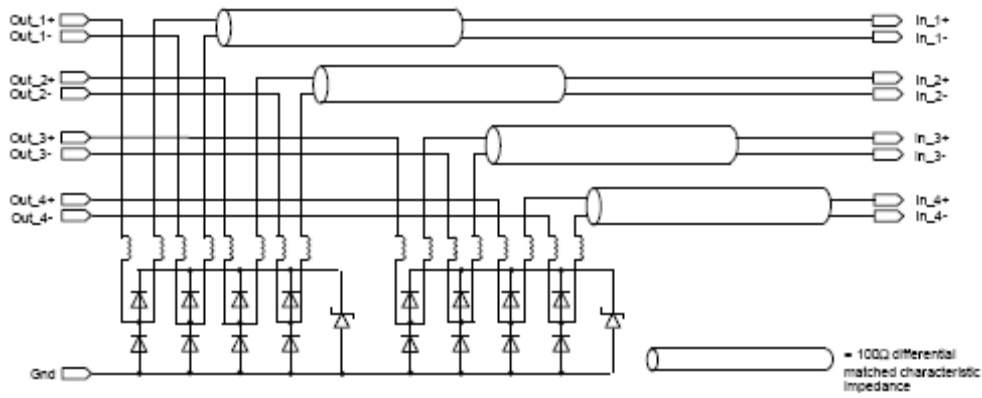

Figure 1. Block Diagram

PicoGuard XS ESD Protection Architecture

Conceptually, an ESD protection device performs the following actions upon an ESD strike discharge into a protected ASIC (see Figure 2):

1. When an ESD potential is applied to the system under test (contact or air-discharge), Kirchoff's Current Law (KCL) dictates that the Electrical Overstress (EOS) currents will immediately divide throughout the circuit, based on the dynamic impedance of each path.
2. Ideally, the classic shunt ESD clamp will switch within 1 ns to a low-impedance path and return the majority of the EOS current to the chassis shield/reference ground. In actuality, if the ESD component's response time (t_{CLAMP}) is slower than the ASIC it is protecting, or if the Dynamic Clamping Resistance (R_{DYN}) is not significantly lower than the ASIC's I/O cell circuitry, then the ASIC will have to absorb a large amount of the EOS energy, and be more likely to fail.
3. Subsequent to the ESD/EOS event, both devices must immediately return to their original specifications, and be ready for an additional strike. Any deterioration in parasitics or clamping capability should be considered a failure, since it can then affect signal integrity or subsequent protection capability. (This is known as "multi-strike" capability.)

In the CM1234 *PicoGuard XS* architecture, the signal line leading the connector to the ASIC routes through the CM1234 chip which provides 100 Ω matched differential

channel characteristic impedance that helps optimize 100 Ω load impedance applications such as the HDMI high speed data lines.

NOTE: When each of the channels are used individually for single-ended signal lines protection, the individual channel provides 50 Ω characteristic impedance matching.

The load impedance matching feature of the CM1234 helps to simplify system designer's PCB layout considerations in impedance matching and also eliminates associated passive components.

The route through the *PicoGuard XS* architecture enables the CM1234 to provide matched impedance for the signal path between the connector and the ASIC. Besides this function, this circuit arrangement also changes the way the parasitic inductance interacts with the ESD protection circuit and helps reduce the $I_{RESIDUAL}$ current to the ASIC.

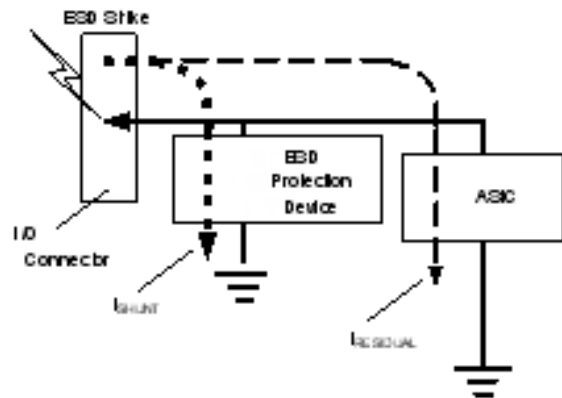

Figure 2. Standard ESD Protection Device Block Diagram

The PicoGuard XS Architecture Advantages

Figure 3 illustrates a standard ESD protection device. The inductor element represents the parasitic inductance arising from the bond wire and the PCB trace leading to the ESD protection diodes.

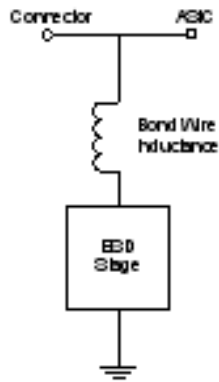

Figure 3. Standard ESD Protection Model

Figure 4 illustrates a standard ESD protection device. The inductor element represents the parasitic inductance arising from the bond wire and the PCB trace leading to the ESD protection diodes.

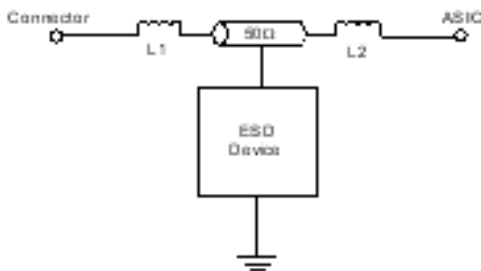

Figure 4. CM1234 PicoGuard XS ESD Protection Model

CM1234 Inductor Elements

In the CM1234 *PicoGuard XS* architecture, the inductor elements and ESD protection diodes interact differently compared to the standard ESD model.

In the standard ESD protection device model, the inductive element presents high impedance against high slew rate strike voltage, i.e. during an ESD strike. The impedance increases the resistance of the conduction path

leading to the ESD protection element. This limits the speed that the ESD pulse can discharge through the ESD protection element.

In the *PicoGuard XS* architecture, the inductive elements are in series to the conduction path leading to the protected device. The elements actually help to limit the current and voltage striking the protected device.

First the reactance of the inductive element, L1, on the connector side when an ESD strike occurs, acts in the opposite direction of the ESD striking current. This helps limit the peak striking voltage. Then the reactance of the inductive element, L2, on the ASIC side forces this limited ESD strike current to be shunted through the ESD protection diodes. At the same time, the voltage drop across both series element acts to lower the clamping voltage at the protected device terminal.

Through this arrangement, the inductive elements also tune the impedance of the ESD protection element by cancelling the capacitive load presented by the ESD diodes to the signal line. This improves the signal integrity and makes the overall ESD protection device more transparent to the high bandwidth data signals passing through the channel.

The innovative *PicoGuard XS* architecture turns the disadvantages of the parasitic inductive elements into useful components that help to limit the ESD current strike to the protected device and also improves the signal integrity of the system by balancing the capacitive loading effects of the ESD diodes. At the same time, this architecture provides an impedance matched signal path for 50 Ω loading applications.

Board designs can take advantage of precision internal component matching for improved signal integrity, which is not otherwise possible with discrete components at the system level. This helps to simplify the PCB layout considerations by the system designer and eliminates the associated passive components for load matching that is normally required with standard ESD protection circuits.

Each ESD channel consists of a pair of diodes in series which steer the positive or negative ESD current pulse to either the Zener diode or to ground. This embedded Zener diode also serves to eliminate the need for a separate bypass capacitor to absorb positive ESD strikes to ground. The CM1234 protects against ESD pulses up to ±18 kv contact per the IEC 61000-4-2 standard.

CM1234

PIN DESCRIPTIONS

Pin	Name	Description
1	In_1+	Bidirectional Clamp to ASIC (inside system)
2	In_1-	Bidirectional Clamp to ASIC (inside system)
3	In_2+	Bidirectional Clamp to ASIC (inside system)
4	In_2-	Bidirectional Clamp to ASIC (inside system)
5	In_3+	Bidirectional Clamp to ASIC (inside system)
6	In_3-	Bidirectional Clamp to ASIC (inside system)
7	In_4+	Bidirectional Clamp to ASIC (inside system)
8	In_4-	Bidirectional Clamp to ASIC (inside system)
9	Out_4-	Bidirectional Clamp to Connector (outside system)
10	Out_4+	Bidirectional Clamp to Connector (outside system)
11	Out_3-	Bidirectional Clamp to Connector (outside system)
12	Out_3+	Bidirectional Clamp to Connector (outside system)
13	Out_2-	Bidirectional Clamp to Connector (outside system)
14	Out_2+	Bidirectional Clamp to Connector (outside system)
15	Out_1-	Bidirectional Clamp to Connector (outside system)
16	Out_1+	Bidirectional Clamp to Connector (outside system)
PAD	GND	Ground return to shield

Specifications

Table 1. ABSOLUTE MAXIMUM RATINGS

Parameter	Rating	Units
Operating Temperature Range	-40 to +85	°C
Storage Temperature Range	-65 to +150	°C
Breakdown Voltage (Positive)	6	V

Stresses exceeding Maximum Ratings may damage the device. Maximum Ratings are stress ratings only. Functional operation above the Recommended Operating Conditions is not implied. Extended exposure to stresses above the Recommended Operating Conditions may affect device reliability.

Table 2. ELECTRICAL OPERATING CHARACTERISTICS

(All parameters specified at $T_A = -40^{\circ}\text{C}$ to $+85^{\circ}\text{C}$ unless otherwise noted.)

Symbol	Parameter	Conditions	Min	Typ	Max	Units
V_{IN}	I/O Voltage Relative to GND		-0.5		5.5	V
I_{IN}	Continuous Current through signal pins (IN to OUT) 1000 Hr			100		mA
I_F	Channel Leakage Current	$T_A = 25^{\circ}\text{C}; V_N = 0\text{ V}, V_{TEST} = 5\text{ V}$		0.1	1.0	μA
V_{ESD}	ESD Protection – Peak Discharge Voltage at any channel input, in system: a) Contact discharge per IEC 61000-4-2 Standard and b) Air discharge per IEC 61000-4-2 Standard	$T_A = 25^{\circ}\text{C}$ $T_A = 25^{\circ}\text{C}$	± 15 ± 20			kV
I_{RES}	Residual ESD Peak Current on RDUP (Resistance of Device Under Protection)	IEC 61000-4-2 8 kV; RDUP = 5 Ω , $T_A = 25^{\circ}\text{C}$		2.5		A
V_{CL}	Channel Clamp Voltage (Channel clamp voltage per IEC 61000-4-5 Standard) Positive Transients Negative Transients	$I_{PP} = 1\text{ A}, T_A = 25^{\circ}\text{C}, t_p = 8/20\ \mu\text{S}$		+9 -1.5		V
R_{DYN}	Dynamic Resistance Positive Transients Negative Transients	$I_{PP} = 1\text{ A}, T_A = 25^{\circ}\text{C}, t_p = 8/20\ \mu\text{S}$		0.44 0.38		Ω
Z_o	Differential Channels pair characteristic impedance	$T_R = 200\text{ ps}$		100		Ω
ΔZ_o	Channel-to-Channel Impedance Match (Differential)	$T_R = 200\text{ ps}$		2		%
$Z_{CHANNEL}$	Individual Channel Characteristic Impedance in Single-ended Connection	$T_R = 200\text{ ps}$		50		Ω
$\Delta Z_{CHANNEL}$	Channel-to-Channel Impedance Match (Individual)	$T_R = 200\text{ ps}$		2		%

Performance Information

Graphical Comparison and Test Setup

Figure 5 shows that the CM1234 (*PicoGuard XS* ESD protector) lowers the peak voltage and clamping voltage by 45% across a wide range of loading conditions in comparison to a standard ESD protection device. Figure 6 also indicates that the DUP/ASIC protected by the CM1234 dissipates less energy than a standard ESD protection device. This data was derived using the test setups shown in Figure 7.

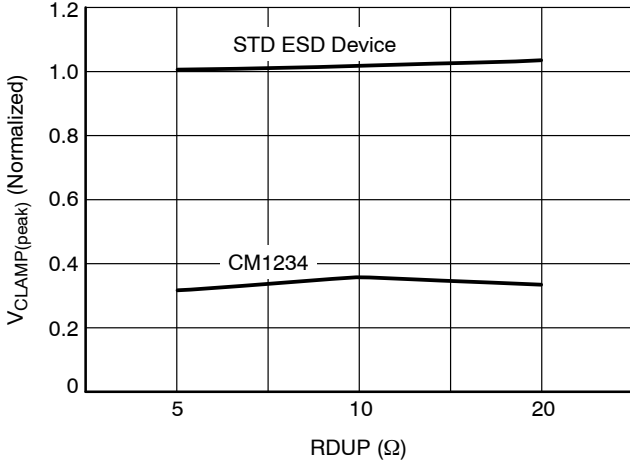

Figure 5. Normalized VPeak (8 KV IEC-61000 4-2 ESD Contact Strike) vs. Loading (RDUP)*

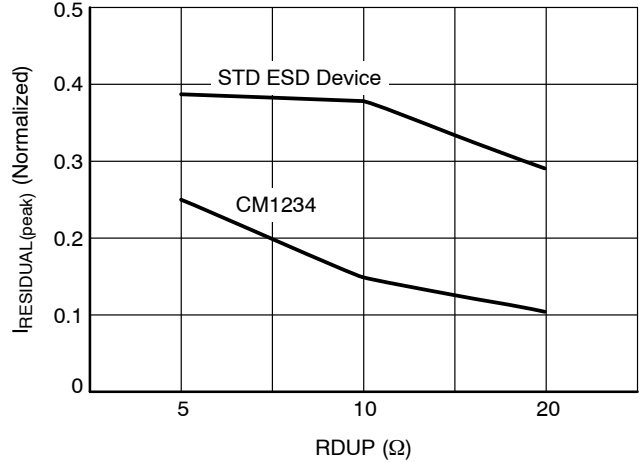

Figure 6. Normalized Residual Current into DUP vs. RDUP*

*RDUP is the emulated Dynamic Resistance (load) of the Device Under Protection (DUP).

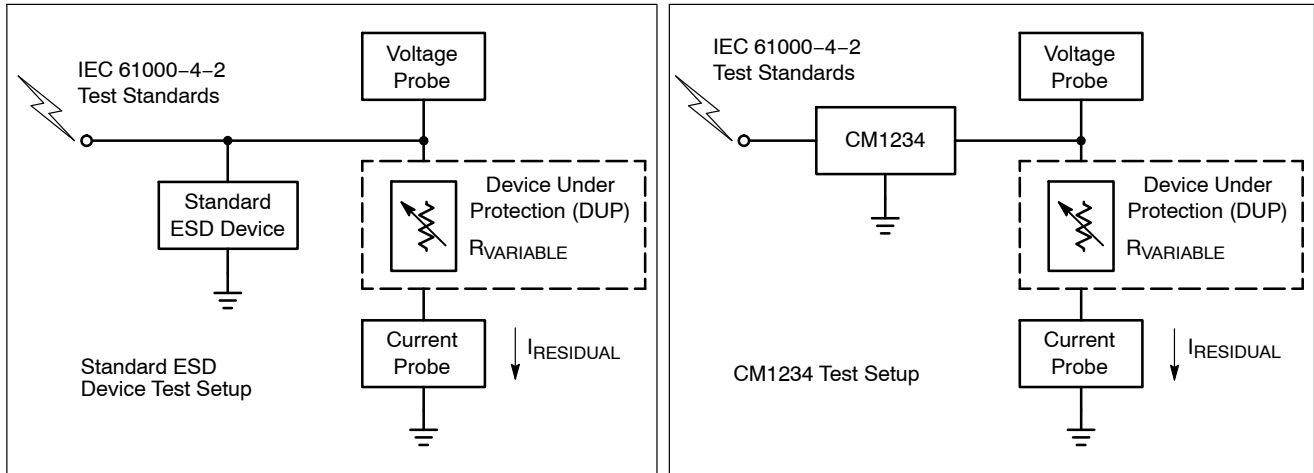

Figure 7. Test Setups: Standard Device (Left) and CM1234 (Right)

CM1234

CM1234 Application and Guidelines

As a general rule, the CM1234 ESD protection array should be located as close as possible to the point of entry of expected electrostatic discharges with minimum PCB trace lengths to the ground planes and between the signal input and the ESD device to minimize stray series inductance.

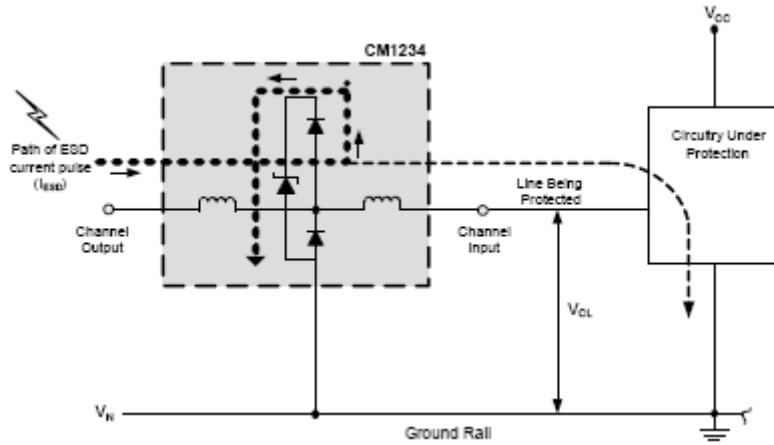

Figure 8. Application of Positive ESD Pulse Between Input Channel and Ground

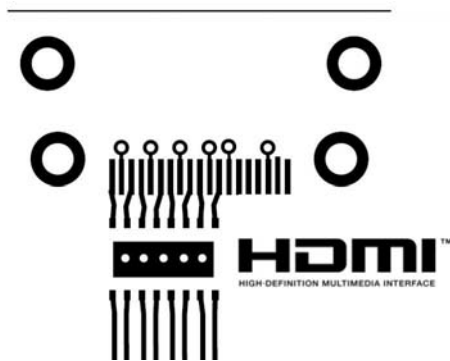

Figure 9. Typical PCB Layout

Additional Information

See also ON Semiconductor Application Note “Design Considerations for ESD Protection,” in the Applications section at www.onsemi.com.

CM1234

Ordering Information

PART NUMBERING INFORMATION

Pin	Package	Ordering Part Number (Lead-Free Finish)	Part Marking
16	WDFN-16	CM1234-08DE	CM1234-08

NOTE: Parts are shipped in Tape & Reel form unless otherwise specified.

TAPE AND REEL SPECIFICATIONS †

Part Number	Package Size (mm)	Pocket Size (mm) $B_0 \times A_0 \times K_0$	Tape Width W	Reel Diameter	Qty per Reel	P_0	P_1
CM1234	6.00 X 4.00 X 0.75	6.30 X 4.30 X 1.10	12 mm	330 mm (13")	3000	4 mm	8 mm

†For information on tape and reel specifications, including part orientation and tape sizes, please refer to our Tape and Reel Packaging Specifications Brochure, BRD8011/D.

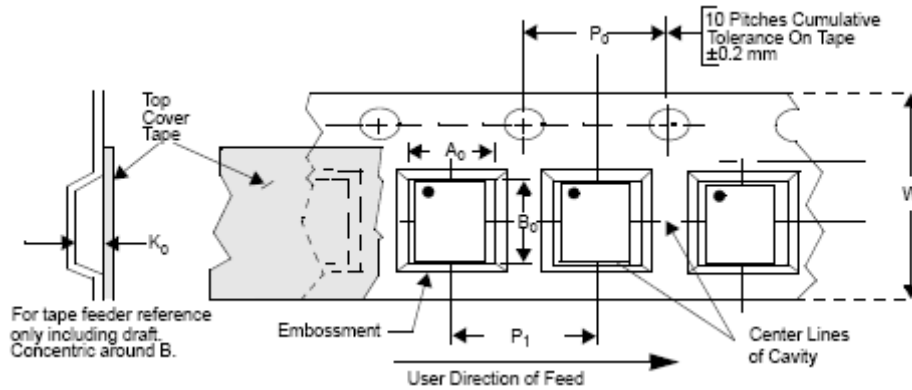

CM1234

PACKAGE DIMENSIONS

WDFN16, 6x4, 0.75P
CASE 511AY-01
ISSUE O

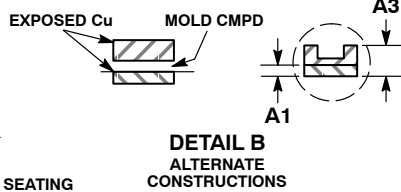
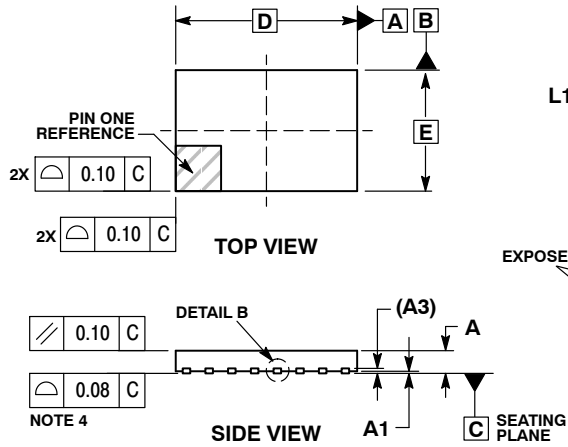

- NOTES:
1. DIMENSIONING AND TOLERANCING PER ASME Y14.5M, 1994.
 2. CONTROLLING DIMENSION: MILLIMETERS.
 3. DIMENSION b APPLIES TO PLATED TERMINAL AND IS MEASURED BETWEEN 0.15 AND 0.30 MM FROM TERMINAL TIP.
 4. COPLANARITY APPLIES TO THE EXPOSED PAD AS WELL AS THE TERMINALS.

MILLIMETERS		
DIM	MIN	MAX
A	0.70	0.80
A1	0.00	0.05
A3	0.20	REF
b	0.20	0.30
D	6.00	BSC
D2	5.05	5.15
E	4.00	BSC
E2	1.75	1.85
e	0.75	BSC
K	0.70	REF
L	0.35	0.45
L1	---	0.15

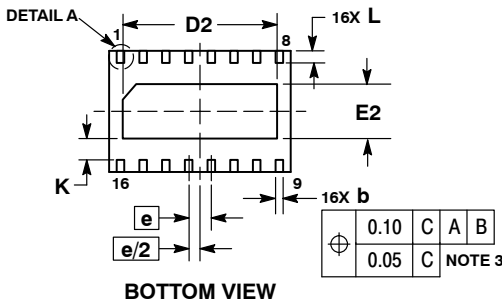

RECOMMENDED SOLDERING FOOTPRINT*

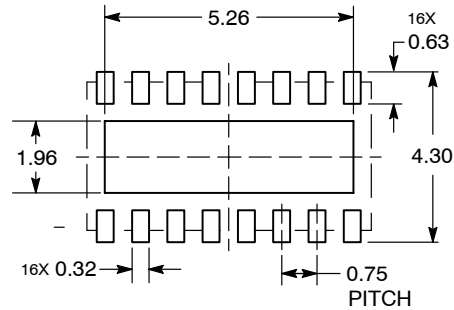

DIMENSION: MILLIMETERS

*For additional information on our Pb-Free strategy and soldering details, please download the ON Semiconductor Soldering and Mounting Techniques Reference Manual, SOLDERRM/D.

PicoGuard is a registered trademark of Semiconductor Components Industries, LLC.

ON Semiconductor and are registered trademarks of Semiconductor Components Industries, LLC (SCILLC). SCILLC reserves the right to make changes without further notice to any products herein. SCILLC makes no warranty, representation or guarantee regarding the suitability of its products for any particular purpose, nor does SCILLC assume any liability arising out of the application or use of any product or circuit, and specifically disclaims any and all liability, including without limitation special, consequential or incidental damages. "Typical" parameters which may be provided in SCILLC data sheets and/or specifications can and do vary in different applications and actual performance may vary over time. All operating parameters, including "Typicals" must be validated for each customer application by customer's technical experts. SCILLC does not convey any license under its patent rights nor the rights of others. SCILLC products are not designed, intended, or authorized for use as components in systems intended for surgical implant into the body, or other applications intended to support or sustain life, or for any other application in which the failure of the SCILLC product could create a situation where personal injury or death may occur. Should Buyer purchase or use SCILLC products for any such unintended or unauthorized application, Buyer shall indemnify and hold SCILLC and its officers, employees, subsidiaries, affiliates, and distributors harmless against all claims, costs, damages, and expenses, and reasonable attorney fees arising out of, directly or indirectly, any claim of personal injury or death associated with such unintended or unauthorized use, even if such claim alleges that SCILLC was negligent regarding the design or manufacture of the part. SCILLC is an Equal Opportunity/Affirmative Action Employer. This literature is subject to all applicable copyright laws and is not for resale in any manner.

PUBLICATION ORDERING INFORMATION

LITERATURE FULFILLMENT:
Literature Distribution Center for ON Semiconductor
P.O. Box 5163, Denver, Colorado 80217 USA
Phone: 303-675-2175 or 800-344-3860 Toll Free USA/Canada
Fax: 303-675-2176 or 800-344-3867 Toll Free USA/Canada
Email: orderlit@onsemi.com

N. American Technical Support: 800-282-9855 Toll Free USA/Canada
Europe, Middle East and Africa Technical Support:
Phone: 421 33 790 2910
Japan Customer Focus Center
Phone: 81-3-5773-3850

ON Semiconductor Website: www.onsemi.com
Order Literature: <http://www.onsemi.com/orderlit>
For additional information, please contact your local Sales Representative