

# CM1263-06DE

## Low Capacitance ESD Protection for High-Speed Serial Interfaces

### Features

- 6 Channels of ESD Protection
- 1 pF Loading Capacitance per Channel Typical
- $\pm 8$  kV ESD Protection (IEC 61000-4-2, Contact Discharge)
- $\pm 15$  kV ESD Protection (IEC 61000-4-2, Air Discharge)
- These Devices are Pb-Free and are RoHS Compliant

### Applications

- LCD and Camera Data Lines in Wireless Handsets that Use High-Speed Serial Interfaces such as MDDI, MIPI, MVI and MPL
- I/O Port Protection for Mobile Handsets, Notebook Computers, PDAs, etc.
- Wireless Handsets
- Handheld PCs/PDAs
- LCD and Camera Modules



ON Semiconductor®

<http://onsemi.com>



UDFN12  
DE SUFFIX  
CASE 517BD

### BLOCK DIAGRAM

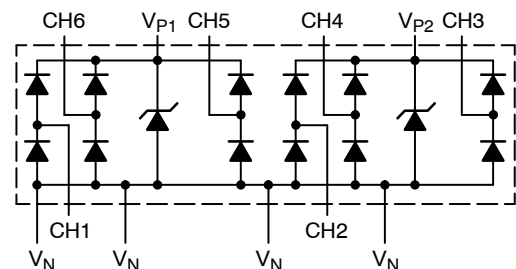

### MARKING DIAGRAM

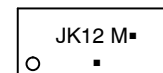

1

JK12 = Specific Device Code  
M = Month Code  
■ = Pb-Free Package

### ORDERING INFORMATION

Device	Package	Shipping†
CM1263-06DE	UDFN (Pb-Free)	3000/Tape & Reel

†For information on tape and reel specifications, including part orientation and tape sizes, please refer to our Tape and Reel Packaging Specification Brochure, BRD8011/D.

Table 1. PIN DESCRIPTIONS

Pin	Description
1	$V_N^*$
2	(CH1) ESD Channel #1
3	$V_N^*$
4	$V_N^*$
5	(CH2) ESD Channel #2
6	$V_N^*$
7	(CH3) ESD Channel #3
8	$V_{P2}$ for Channels 2, 3, and 4
9	(CH4) ESD Channel #4
10	(CH5) ESD Channel #5
11	$V_{P1}$ for Channels 1, 5, and 6
12	(CH6) ESD Channel #6
DAP*	Backside, GND Pad, $V_N^*$

PACKAGE / PINOUT DIAGRAM

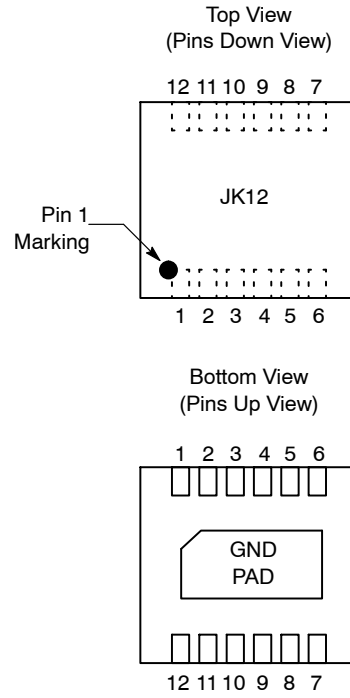

12-Lead UDFN Package

# CM1263–06DE

## SPECIFICATIONS

**Table 2. ABSOLUTE MAXIMUM RATINGS**

Parameter	Rating	Units
Operating Supply Voltage ( $V_P - V_N$ )	6.0	V
Operating Temperature Range	-40 to +85	°C
Storage Temperature Range	-65 to +150	°C
DC Voltage at any channel input	$(V_N - 0.5)$ to $(V_P + 0.5)$	V

Stresses exceeding Maximum Ratings may damage the device. Maximum Ratings are stress ratings only. Functional operation above the Recommended Operating Conditions is not implied. Extended exposure to stresses above the Recommended Operating Conditions may affect device reliability.

**Table 3. ELECTRICAL OPERATING CHARACTERISTICS** (Note 1)

Symbol	Parameter	Conditions	Min	Typ	Max	Units
$V_P$	Operating Supply Voltage ( $V_P - V_N$ )			3.3	5.5	V
$I_P$	Operating Supply Current	$V_P = 3.3$ V, $V_N = 0$ V (per $V_P$ pin)			8.0	$\mu$ A
$V_F$	Diode Forward Voltage Top Diode Bottom Diode	$T_A = 25^\circ\text{C}$ , $I_F = 8$ mA, $V_P = 3.3$ V, $V_N = 0$ V	0.60 0.60	0.80 0.80	0.95 0.95	V
$I_{LEAK}$	Channel Leakage Current	$T_A = 25^\circ\text{C}$ ; $V_P = 3.3$ V, $V_N = 0$ V (Channel 1)			250	nA
		$V_P = 3.3$ V, $V_N = 0$ V (Channels 1–6)			1000	nA
$I_R$	Reverse (Leakage Current)	$V_P = \text{floating}$ ; $V_N = 0$ V (per channel)			1000	nA
$C_{IN}$	Channel Input Capacitance	At 1 MHz, $V_P = 3.3$ V, $V_N = 0$ V, $V_{IN} = 0$ V		0.88	1.2	pF
$\Delta C_{IN}$	Channel Input Capacitance Matching	At 1 MHz, $V_P = 3.3$ V, $V_N = 0$ V, $V_{IN} = 0$ V		0.02		pF
$C_{MUTUAL}$	Mutual Capacitance between signal pin and adjacent signal pin	At 1 MHz, $V_P = 3.3$ V, $V_N = 0$ V, $V_{IN} = 0$ V		0.11		pF
$V_{ESD}$	ESD Protection Peak Discharge Voltage at any channel input, in system a) Contact discharge per IEC 61000–4–2 standard b) Air discharge per IEC 61000–4–2 standard	$T_A = 25^\circ\text{C}$ (Notes 2 and 3)	$\pm 8$ $\pm 15$			kV
$V_{CL}$	Channel Clamp Voltage Positive Transients Negative Transients	$T_A = 25^\circ\text{C}$ , $I_{PP} = 1$ A, $t_p = 8/20$ $\mu$ S (Note 3)		+9.96 -1.6		V
$R_{DYN}$	Dynamic Resistance Positive Transients Negative Transients	$T_A = 25^\circ\text{C}$ , $I_{PP} = 1$ A, $t_p = 8/20$ $\mu$ S Any I/O pin to Ground (Note 3)		0.96 0.5		$\Omega$

1. All parameters specified at  $T_A = -40^\circ\text{C}$  to  $+85^\circ\text{C}$  unless otherwise noted.
2. Standard IEC 61000–4–2 with  $C_{Discharge} = 150$  pF,  $R_{Discharge} = 330$   $\Omega$ ,  $V_P = 3.3$  V,  $V_N$  grounded.
3. These measurements performed with no external capacitor on  $V_P$  ( $V_P$  floating).

# CM1263-06DE

## PACKAGE DIMENSIONS

UDFN12, 2.5x1.35, 0.4P  
CASE 517BD-01  
ISSUE O

SCALE 4:1

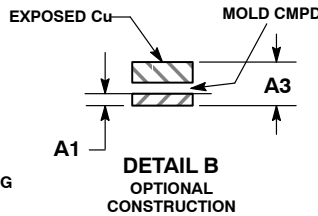
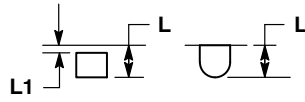
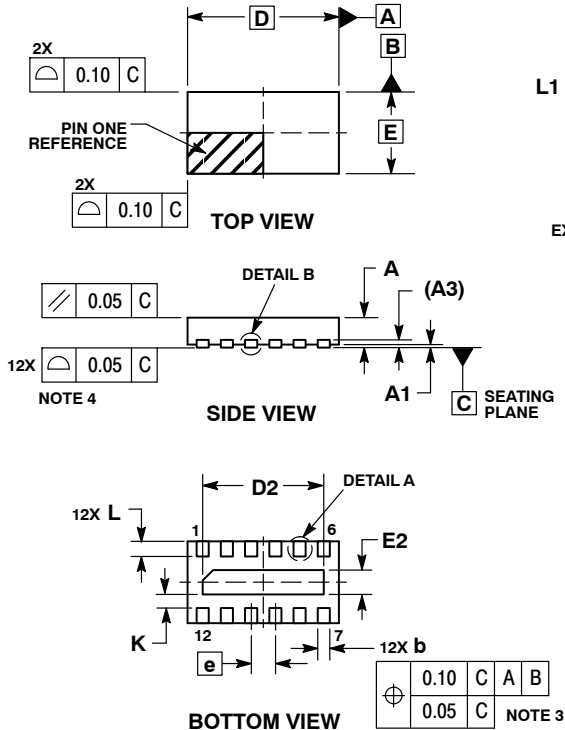

- NOTES:
1. DIMENSIONING AND TOLERANCING PER ASME Y14.5M, 1994.
  2. CONTROLLING DIMENSION: MILLIMETERS.
  3. DIMENSION b APPLIES TO PLATED TERMINAL AND IS MEASURED BETWEEN 0.15 AND 0.25 mm FROM THE TERMINAL TIP.
  4. COPLANARITY APPLIES TO THE EXPOSED PAD AS WELL AS THE TERMINALS.

DIM	MILLIMETERS	
	MIN	MAX
A	0.45	0.55
A1	0.00	0.05
A3	0.13	REF
b	0.15	0.25
D	2.50	BSC
D2	1.90	2.10
E	1.35	BSC
E2	0.30	0.50
e	0.40	BSC
K	0.15	---
L	0.20	0.30
L1	---	0.05

### RECOMMENDED SOLDERING FOOTPRINT\*

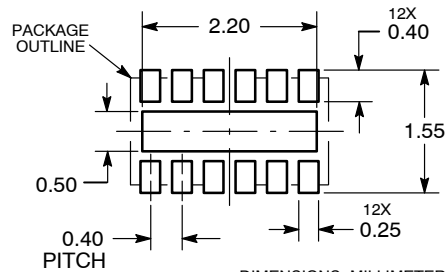

\*For additional information on our Pb-Free strategy and soldering details, please download the ON Semiconductor Soldering and Mounting Techniques Reference Manual, SOLDERRM/D.

ON Semiconductor and are registered trademarks of Semiconductor Components Industries, LLC (SCILLC). SCILLC reserves the right to make changes without further notice to any products herein. SCILLC makes no warranty, representation or guarantee regarding the suitability of its products for any particular purpose, nor does SCILLC assume any liability arising out of the application or use of any product or circuit, and specifically disclaims any and all liability, including without limitation special, consequential or incidental damages. "Typical" parameters which may be provided in SCILLC data sheets and/or specifications can and do vary in different applications and actual performance may vary over time. All operating parameters, including "Typicals" must be validated for each customer application by customer's technical experts. SCILLC does not convey any license under its patent rights nor the rights of others. SCILLC products are not designed, intended, or authorized for use as components in systems intended for surgical implant into the body, or other applications intended to support or sustain life, or for any other application in which the failure of the SCILLC product could create a situation where personal injury or death may occur. Should Buyer purchase or use SCILLC products for any such unintended or unauthorized application, Buyer shall indemnify and hold SCILLC and its officers, employees, subsidiaries, affiliates, and distributors harmless against all claims, costs, damages, and expenses, and reasonable attorney fees arising out of, directly or indirectly, any claim of personal injury or death associated with such unintended or unauthorized use, even if such claim alleges that SCILLC was negligent regarding the design or manufacture of the part. SCILLC is an Equal Opportunity/Affirmative Action Employer. This literature is subject to all applicable copyright laws and is not for resale in any manner.

### PUBLICATION ORDERING INFORMATION

**LITERATURE FULFILLMENT:**  
Literature Distribution Center for ON Semiconductor  
P.O. Box 5163, Denver, Colorado 80217 USA  
Phone: 303-675-2175 or 800-344-3860 Toll Free USA/Canada  
Fax: 303-675-2176 or 800-344-3867 Toll Free USA/Canada  
Email: orderlit@onsemi.com

**N. American Technical Support:** 800-282-9855 Toll Free  
USA/Canada  
**Europe, Middle East and Africa Technical Support:**  
Phone: 421 33 790 2910  
**Japan Customer Focus Center**  
Phone: 81-3-5773-3850

**ON Semiconductor Website:** [www.onsemi.com](http://www.onsemi.com)  
**Order Literature:** <http://www.onsemi.com/orderlit>  
For additional information, please contact your local Sales Representative