

# MBRAF440T3G

## Surface Mount Schottky Power Rectifier

This device employs the Schottky Barrier principle in a large area metal-to-silicon power diode. State-of-the-art geometry features epitaxial construction with oxide passivation and metal overlay contact. Ideally suited for low voltage, high frequency rectification, or as free wheeling and polarity protection diodes in surface mount applications where compact size and weight are critical to the system.

### Features

- Low Profile Package for Space Constrained Applications
- Rectangular Package for Automated Handling
- Highly Stable Oxide Passivated Junction
- 150°C Operating Junction Temperature
- Guard-Ring for Stress Protection
- These are Pb-Free and Halide-Free Devices

### Mechanical Characteristics

- Case: Epoxy, Molded, Epoxy Meets UL 94, V-0
- Weight: 95 mg (approximately)
- Finish: All External Surfaces Corrosion Resistant and Terminal Leads are Readily Solderable
- Lead and Mounting Surface Temperature for Soldering Purposes: 260°C Max. for 10 Seconds
- Cathode Polarity Band
- Device Meets MSL 1 Requirements
- ESD Ratings: Machine Model = A  
Human Body Model = 1B



**ON Semiconductor®**

<http://onsemi.com>

**SCHOTTKY BARRIER  
RECTIFIER  
4.0 AMPERE  
40 VOLTS**

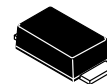

**SMA-FL  
CASE 403AA  
STYLE 6**

### MARKING DIAGRAM



RAF = Specific Device Code  
A = Assembly Location  
Y = Year  
WW = Work Week  
▪ = Pb-Free Package  
(Note: Microdot may be in either location)

### ORDERING INFORMATION

Device	Package	Shipping <sup>†</sup>
MBRAF440T3G	SMA-FL (Pb-Free)	5000 / Tape & Reel

<sup>†</sup>For information on tape and reel specifications, including part orientation and tape sizes, please refer to our Tape and Reel Packaging Specification Brochure, BRD8011/D.

# MBRAF440T3G

## MAXIMUM RATINGS

Rating	Symbol	Value	Unit
Peak Repetitive Reverse Voltage Working Peak Reverse Voltage DC Blocking Voltage	$V_{RRM}$ $V_{RWM}$ $V_R$	40	V
Average Rectified Forward Current (At Rated $V_R$ , $T_L = 107^\circ\text{C}$ )	$I_O$	4.0	A
Non-Repetitive Peak Surge Current (Surge Applied at Rated Load Conditions Halfwave, Single Phase, 60 Hz)	$I_{FSM}$	100	A
Storage/Operating Case Temperature	$T_{stg}, T_C$	-55 to +150	$^\circ\text{C}$
Operating Junction Temperature (Note 1)	$T_J$	-55 to +150	$^\circ\text{C}$
Voltage Rate of Change (Rated $V_R$ , $T_J = 25^\circ\text{C}$ )	dv/dt	10,000	V/ $\mu\text{s}$

Stresses exceeding Maximum Ratings may damage the device. Maximum Ratings are stress ratings only. Functional operation above the Recommended Operating Conditions is not implied. Extended exposure to stresses above the Recommended Operating Conditions may affect device reliability.

1. The heat generated must be less than the thermal conductivity from Junction-to-Ambient:  $dP_D/dT_J < 1/R_{\theta JA}$ .

## THERMAL CHARACTERISTICS

Characteristic	Symbol	Value	Unit
Thermal Resistance – Junction-to-Lead (Note 2)	$R_{\theta JL}$	25	$^\circ\text{C}/\text{W}$
Thermal Resistance – Junction-to-Ambient (Note 2)	$R_{\theta JA}$	90	

2. 1 inch square pad size (1 × 0.5 inch) for each lead on FR4 board.

## ELECTRICAL CHARACTERISTICS

Characteristic	Symbol	Value		Unit
		$T_J = 25^\circ\text{C}$	$T_J = 100^\circ\text{C}$	
Maximum Instantaneous Forward Voltage (Note 3) ( $I_F = 4.0\text{ A}$ )	$V_F$	0.485	0.435	V
Maximum Instantaneous Reverse Current ( $V_R = 40\text{ V}$ )	$I_R$	0.3	15	mA

3. Pulse Test: Pulse Width  $\leq 250\ \mu\text{s}$ , Duty Cycle  $\leq 2.0\%$ .

# MBRAF440T3G

## TYPICAL CHARACTERISTICS

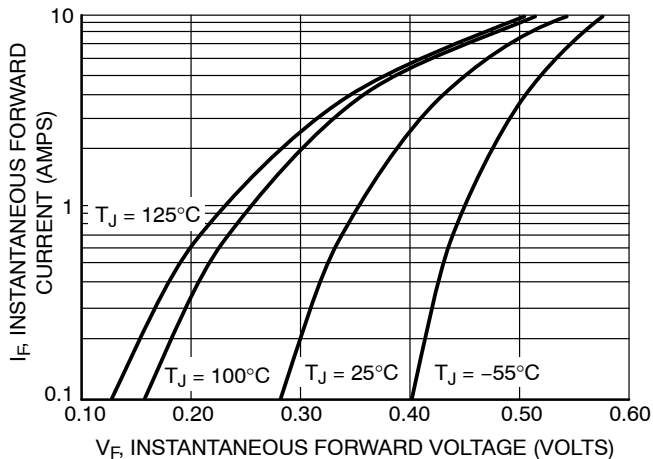

Figure 1. Typical Forward Voltage

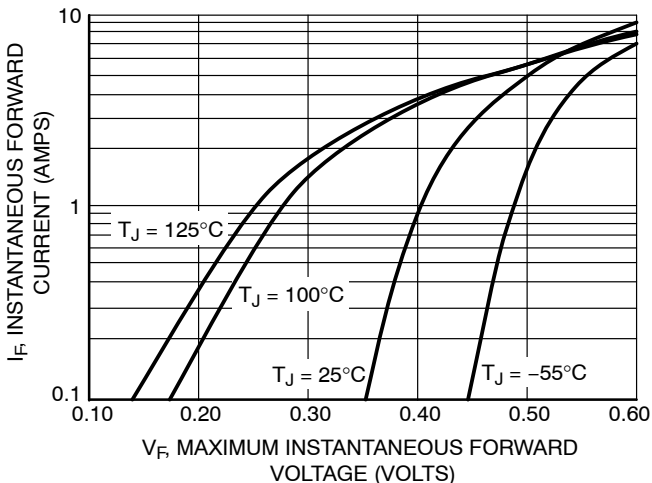

Figure 2. Maximum Forward Voltage

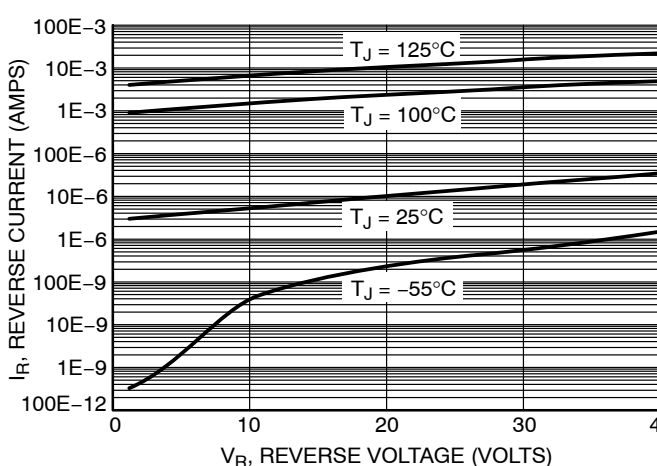

Figure 3. Typical Reverse Current

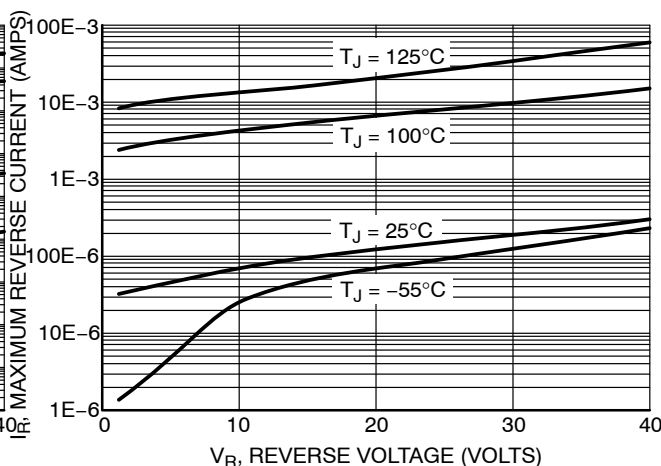

Figure 4. Maximum Reverse Current

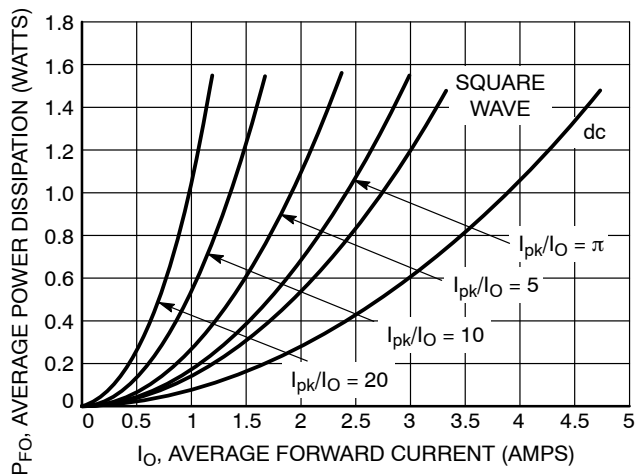

Figure 5. Forward Power Dissipation

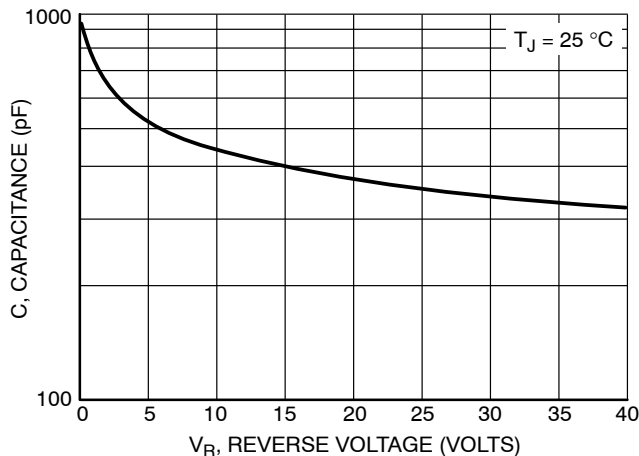

Figure 6. Capacitance

# MBRAF440T3G

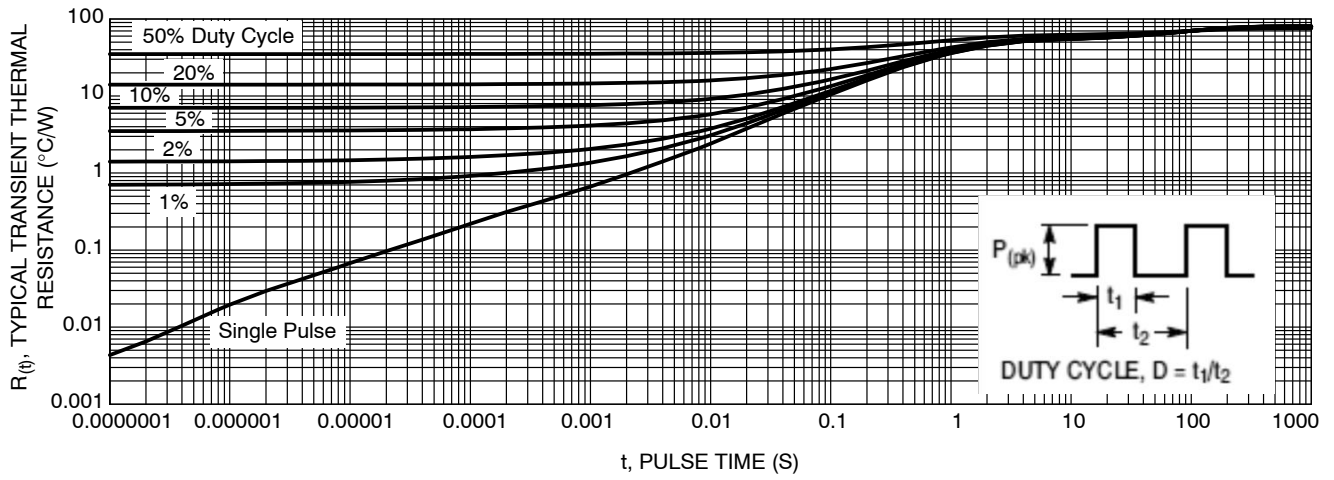
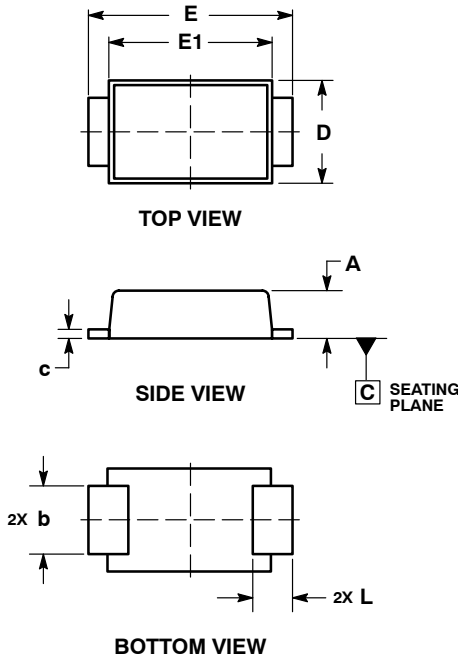

Figure 7. Typical Transient Thermal Response, Junction-to-Ambient

# MBRAF440T3G

## PACKAGE DIMENSIONS

SMA-FL  
CASE 403AA  
ISSUE O



- NOTES:
1. DIMENSIONING AND TOLERANCING PER ASME Y14.5M, 1994.
  2. CONTROLLING DIMENSION: MILLIMETERS.

MILLIMETERS		
DIM	MIN	MAX
A	0.90	1.10
b	1.25	1.65
c	0.15	0.30
D	2.40	2.80
E	4.80	5.40
E1	4.00	4.60
L	0.70	1.10

### RECOMMENDED SOLDER FOOTPRINT\*

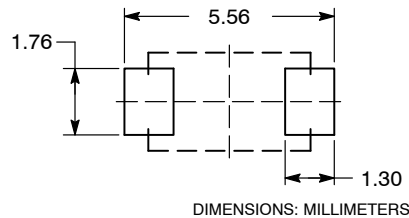

\*For additional information on our Pb-Free strategy and soldering details, please download the ON Semiconductor Soldering and Mounting Techniques Reference Manual, SOLDERRM/D.

ON Semiconductor and  are registered trademarks of Semiconductor Components Industries, LLC (SCILLC). SCILLC owns the rights to a number of patents, trademarks, copyrights, trade secrets, and other intellectual property. A listing of SCILLC's product/patent coverage may be accessed at [www.onsemi.com/site/pdf/Patent-Marking.pdf](http://www.onsemi.com/site/pdf/Patent-Marking.pdf). SCILLC reserves the right to make changes without further notice to any products herein. SCILLC makes no warranty, representation or guarantee regarding the suitability of its products for any particular purpose, nor does SCILLC assume any liability arising out of the application or use of any product or circuit, and specifically disclaims any and all liability, including without limitation special, consequential or incidental damages. "Typical" parameters which may be provided in SCILLC data sheets and/or specifications can and do vary in different applications and actual performance may vary over time. All operating parameters, including "Typicals" must be validated for each customer application by customer's technical experts. SCILLC does not convey any license under its patent rights nor the rights of others. SCILLC products are not designed, intended, or authorized for use as components in systems intended for surgical implant into the body, or other applications intended to support or sustain life, or for any other application in which the failure of the SCILLC product could create a situation where personal injury or death may occur. Should Buyer purchase or use SCILLC products for any such unintended or unauthorized application, Buyer shall indemnify and hold SCILLC and its officers, employees, subsidiaries, affiliates, and distributors harmless against all claims, costs, damages, and expenses, and reasonable attorney fees arising out of, directly or indirectly, any claim of personal injury or death associated with such unintended or unauthorized use, even if such claim alleges that SCILLC was negligent regarding the design or manufacture of the part. SCILLC is an Equal Opportunity/Affirmative Action Employer. This literature is subject to all applicable copyright laws and is not for resale in any manner.

### PUBLICATION ORDERING INFORMATION

**LITERATURE FULFILLMENT:**  
Literature Distribution Center for ON Semiconductor  
P.O. Box 5163, Denver, Colorado 80217 USA  
**Phone:** 303-675-2175 or 800-344-3860 Toll Free USA/Canada  
**Fax:** 303-675-2176 or 800-344-3867 Toll Free USA/Canada  
**Email:** [orderlit@onsemi.com](mailto:orderlit@onsemi.com)

**N. American Technical Support:** 800-282-9855 Toll Free  
USA/Canada  
**Europe, Middle East and Africa Technical Support:**  
Phone: 421 33 790 2910  
**Japan Customer Focus Center**  
Phone: 81-3-5817-1050

**ON Semiconductor Website:** [www.onsemi.com](http://www.onsemi.com)  
**Order Literature:** <http://www.onsemi.com/orderlit>  
For additional information, please contact your local Sales Representative