

# MC33269, NCV33269

## 800 mA, Adjustable Output, Low Dropout Voltage Regulator

The MC33269/NCV33269 series are low dropout, medium current, fixed and adjustable, positive voltage regulators specifically designed for use in low input voltage applications. These devices offer the circuit designer an economical solution for precision voltage regulation, while keeping power losses to a minimum.

The regulator consists of a 1.0 V dropout composite PNP-NPN pass transistor, current limiting, and thermal shutdown.

### Features

- 3.3 V, 5.0 V, 12 V and Adjustable Versions  
2.85 V version available as MC34268
- Space Saving DPAK, SO-8 and SOT-223 Power Packages
- 1.0 V Dropout
- Output Current in Excess of 800 mA
- Thermal Protection
- Short Circuit Protection
- Output Trimmed to 1.0% Tolerance
- NCV Prefix for Automotive and Other Applications Requiring Unique Site and Control Change Requirements; AEC-Q100 Qualified and PPAP Capable
- These are Pb-Free Devices

### DEVICE TYPE/NOMINAL OUTPUT VOLTAGE

MC33269D	Adj	MC33269D-5.0	5.0 V
NCV33269D*	Adj	MC33269DT-5.0	5.0 V
MC33269DT	Adj	NCV33269DT-5.0*	5.0 V
NCV33269DTRK*	Adj	NCV33269DTRK-5.0*	5.0 V
MC33269T	3.3 V	MC33269T-5.0	5.0 V
MC33269D-3.3	3.3 V	MC33269D-012	12 V
MC33269DT-3.3	3.3 V	MC33269DT-012	12 V
NCV33269DTRK-3.3*	3.3 V	NCV33269DTRK-012*	12 V
MC33269T-3.3	3.3 V	MC33269T-012	12 V
MC33269ST-3.3			

\*NCV Prefix for Automotive and Other Applications Requiring Unique Site and Control Change Requirements; AEC-Q100 Qualified and PPAP Capable.



ON Semiconductor®

<http://onsemi.com>

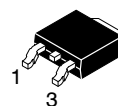
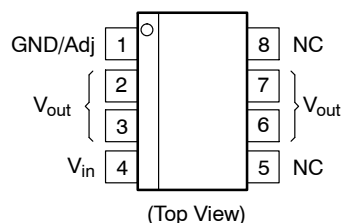

DPAK  
DT SUFFIX  
CASE 369C

1. GND/Adj
2.  $V_{out}$
3.  $V_{in}$

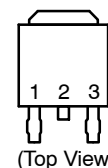

SOT-223  
ST SUFFIX  
CASE 318E

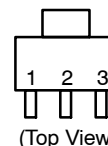

Heatsink surface (shown as terminal 4 in case outline drawing) is connected to Pin 2.

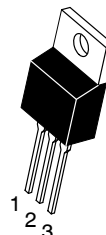

TO-220AB  
T SUFFIX  
CASE 221AB

1. GND/Adj
2.  $V_{out}$
3.  $V_{in}$

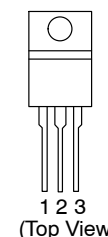

Heatsink surface (shown as terminal 4 in case outline drawing) is connected to Pin 2.

### ORDERING INFORMATION

See detailed ordering and shipping information in the package dimensions section on page 7 of this data sheet.

### DEVICE MARKING INFORMATION

See general marking information in the device marking section on page 8 of this data sheet.

# MC33269, NCV33269

## MAXIMUM RATINGS

Rating	Symbol	Value	Unit
Power Supply Input Voltage	$V_{in}$	20	V
Power Dissipation			
Case 369C (DPAK) $T_A = 25^\circ\text{C}$	$P_D$	Internally Limited	W
Thermal Resistance, Junction-to-Ambient	$\theta_{JA}$	92	$^\circ\text{C/W}$
Thermal Resistance, Junction-to-Case	$\theta_{JC}$	6.0	$^\circ\text{C/W}$
Case 751 (SO-8) $T_A = 25^\circ\text{C}$	$P_D$	Internally Limited	W
Thermal Resistance, Junction-to-Ambient	$\theta_{JA}$	160	$^\circ\text{C/W}$
Thermal Resistance, Junction-to-Case	$\theta_{JC}$	25	$^\circ\text{C/W}$
Case 221A (TO-220) $T_A = 25^\circ\text{C}$	$P_D$	Internally Limited	W
Thermal Resistance, Junction-to-Ambient	$\theta_{JA}$	65	$^\circ\text{C/W}$
Thermal Resistance, Junction-to-Case	$\theta_{JC}$	5.0	$^\circ\text{C/W}$
Case 318E (SOT-223) $T_A = 25^\circ\text{C}$	$P_D$	Internally Limited	W
Thermal Resistance, Junction-to-Ambient	$\theta_{JA}$	156	$^\circ\text{C/W}$
Thermal Resistance, Junction-to-Case	$\theta_{JC}$	15	$^\circ\text{C/W}$
Operating Die Junction Temperature Range	$T_J$	-40 to +150	$^\circ\text{C}$
Operating Ambient Temperature Range MC33269 NCV33269	$T_A$	-40 to +125 -40 to +125	$^\circ\text{C}$
Storage Temperature	$T_{stg}$	-55 to +150	$^\circ\text{C}$
Electrostatic Discharge Sensitivity (ESD) Human Body Model (HBM) Machine Model (MM)	ESD	4000 400	V

Stresses exceeding Maximum Ratings may damage the device. Maximum Ratings are stress ratings only. Functional operation above the Recommended Operating Conditions is not implied. Extended exposure to stresses above the Recommended Operating Conditions may affect device reliability.

## ELECTRICAL CHARACTERISTICS ( $C_O = 10 \mu\text{F}$ , $T_A = 25^\circ\text{C}$ , for min/max values $T_A = -40^\circ\text{C}$ to $+125^\circ\text{C}$ , unless otherwise noted.)

Characteristic	Symbol	Min	Typ	Max	Unit
Output Voltage ( $I_{out} = 10 \text{ mA}$ , $T_A = 25^\circ\text{C}$ ) 3.3 Suffix ( $V_{CC} = 5.3 \text{ V}$ ) 5.0 Suffix ( $V_{CC} = 7.0 \text{ V}$ ) 12 Suffix ( $V_{CC} = 14 \text{ V}$ )	$V_O$	3.27 4.95 11.88	3.3 5.0 12	3.33 5.05 12.12	V
Output Voltage (Line, Load and Temperature) (Note 1) ( $1.25 \text{ V} \leq V_{in} - V_{out} \leq 15 \text{ V}$ , $I_{out} = 500 \text{ mA}$ ) ( $1.35 \text{ V} \leq V_{in} - V_{out} \leq 10 \text{ V}$ , $I_{out} = 800 \text{ mA}$ ) 3.3 Suffix 5.0 Suffix 12 Suffix	$V_O$	3.23 4.9 11.76	3.3 5.0 12	3.37 5.1 12.24	V
Reference Voltage for Adjustable Voltage ( $I_{out} = 10 \text{ mA}$ , $V_{in} - V_{out} = 2.0 \text{ V}$ , $T_A = 25^\circ\text{C}$ )	$V_{ref}$	1.235	1.25	1.265	V
Reference Voltage (Line, Load and Temperature) (Note 1) for Adjustable Voltage ( $1.25 \text{ V} \leq V_{in} - V_{out} \leq 15 \text{ V}$ , $I_{out} = 500 \text{ mA}$ ) ( $1.35 \text{ V} \leq V_{in} - V_{out} \leq 10 \text{ V}$ , $I_{out} = 800 \text{ mA}$ )	$V_{ref}$	1.225	1.25	1.275	V
Line Regulation ( $I_{out} = 10 \text{ mA}$ , $V_{in} = [V_{out} + 1.5 \text{ V}]$ to $V_{in} = 20 \text{ V}$ , $T_A = 25^\circ\text{C}$ )	$Reg_{line}$	-	-	0.3	%
Load Regulation ( $V_{in} = V_{out} + 3.0 \text{ V}$ , $I_{out} = 10 \text{ mA}$ to $800 \text{ mA}$ , $T_A = 25^\circ\text{C}$ )	$Reg_{load}$	-	-	0.5	%
Dropout Voltage ( $I_{out} = 500 \text{ mA}$ ) ( $I_{out} = 800 \text{ mA}$ )	$V_{in} - V_{out}$	-	1.0 1.1	1.25 1.35	V
Ripple Rejection (10 $V_{pp}$ , 120 Hz Sinewave; $I_{out} = 500 \text{ mA}$ )	RR	55	-	-	dB
Current Limit ( $V_{in} - V_{out} = 10 \text{ V}$ )	$I_{Limit}$	800	-	-	mA
Quiescent Current (Fixed Output) ( $1.5 \text{ V} \leq V_{out} \leq 3.3 \text{ V}$ ) ( $5 \text{ V} \leq V_{out} \leq 12 \text{ V}$ )	$I_Q$	-	5.5	8.0 20	mA
Minimum Required Load Current Fixed Output Voltage Adjustable Voltage	$I_{Load}$	- 8.0	-	0	mA
Adjustment Pin Current	$I_{Adj}$	-	-	120	$\mu\text{A}$

1. The MC33269-12,  $V_{in} - V_{out}$  is limited to 8.0 V maximum, because of the 20 V maximum rating applied to  $V_{in}$ .

MC33269, NCV33269

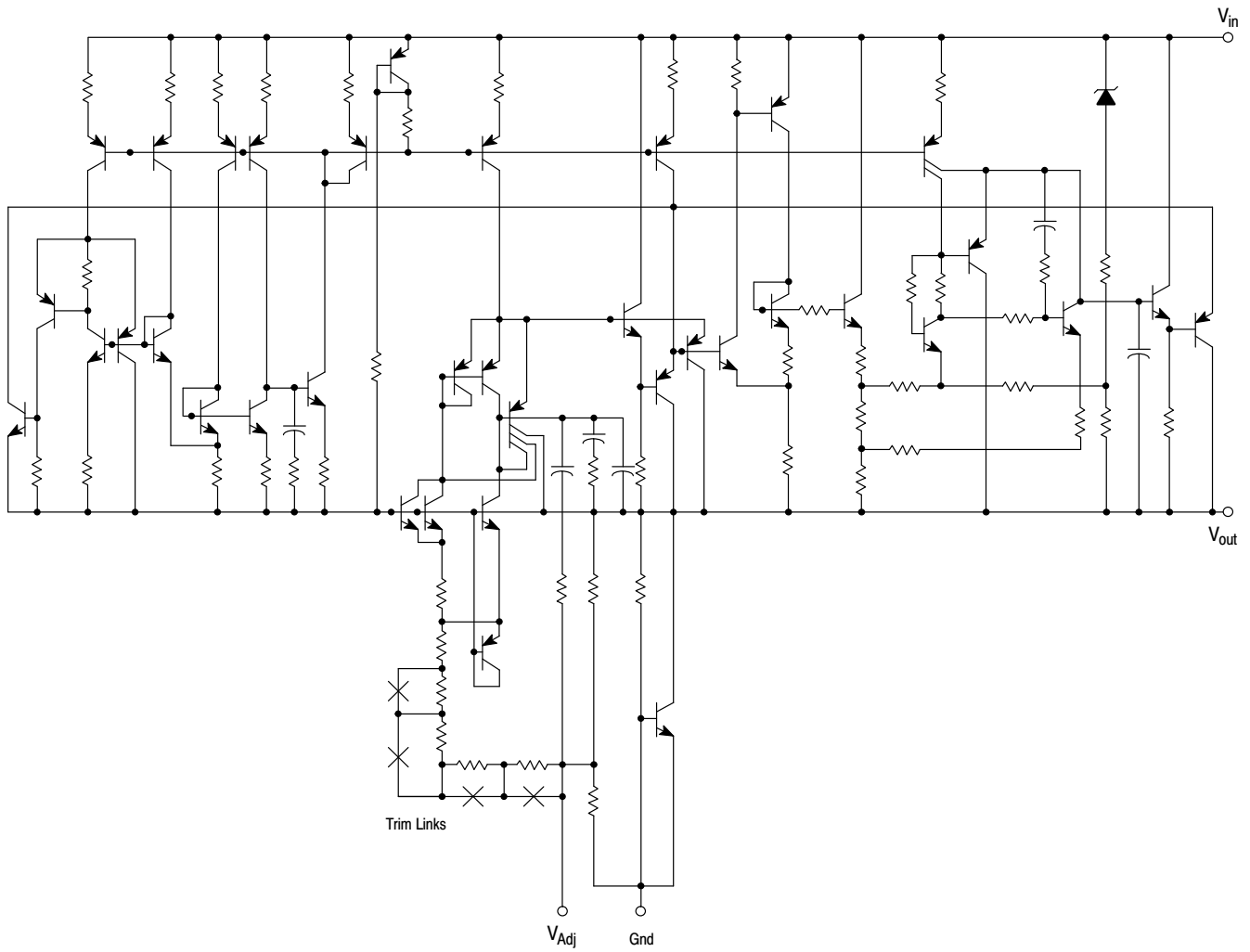

This device contains 38 active transistors.

Figure 1. Internal Schematic

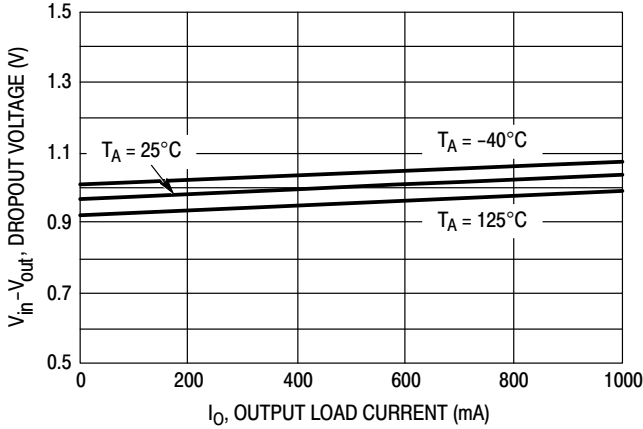

Figure 2. Dropout Voltage versus Output Load Current

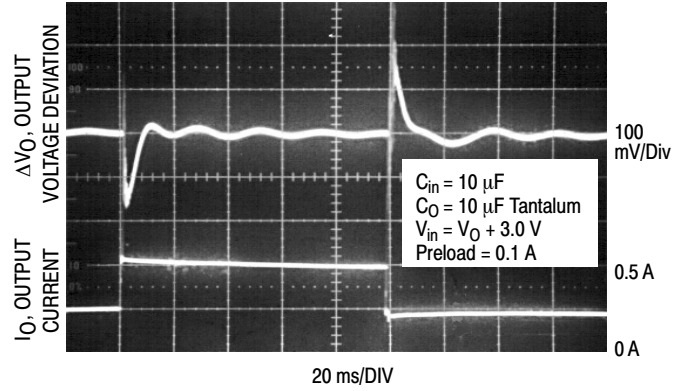

Figure 3. Transient Load Regulation

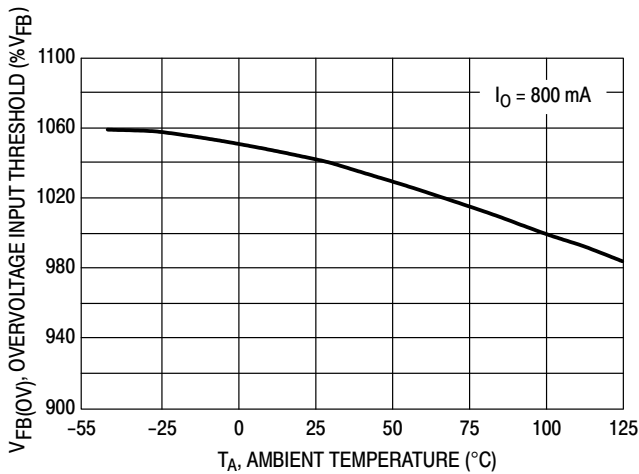

Figure 4. Dropout Voltage versus Temperature

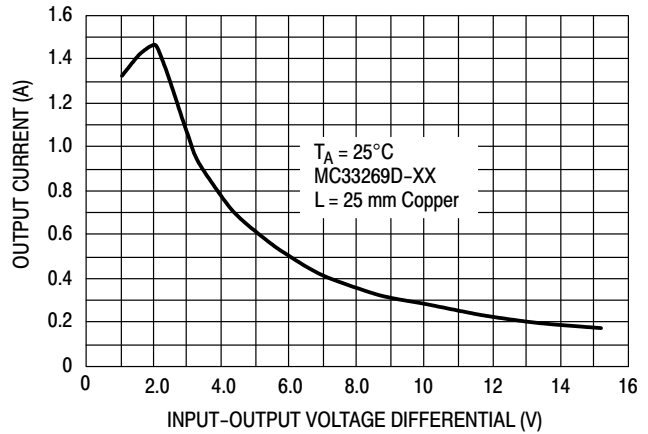

Figure 5. MC33269-XX Output DC Current versus Input-Output Differential Voltage

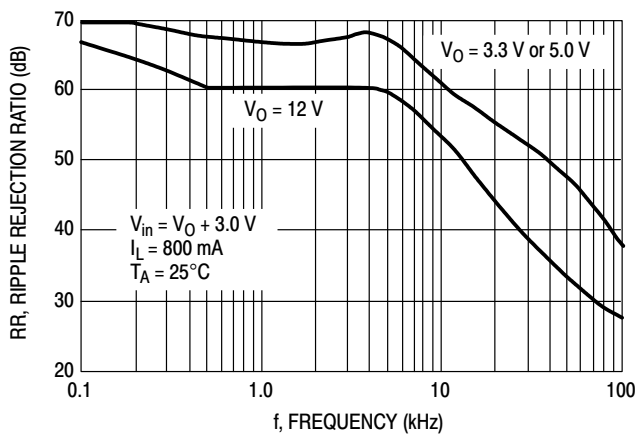

Figure 6. MC33269 Ripple Rejection versus Frequency

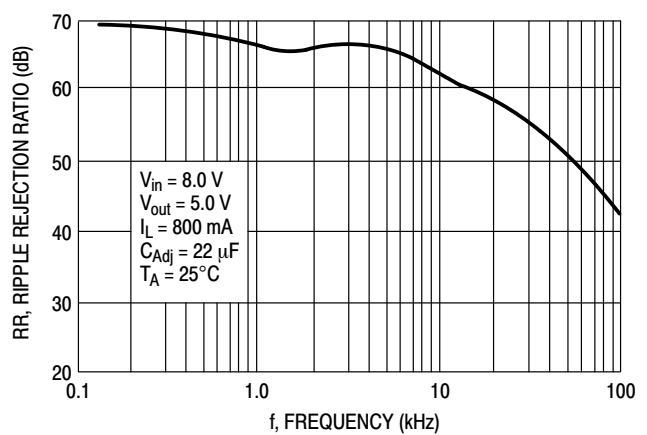

Figure 7. MC33269-ADJ Ripple Rejection versus Frequency

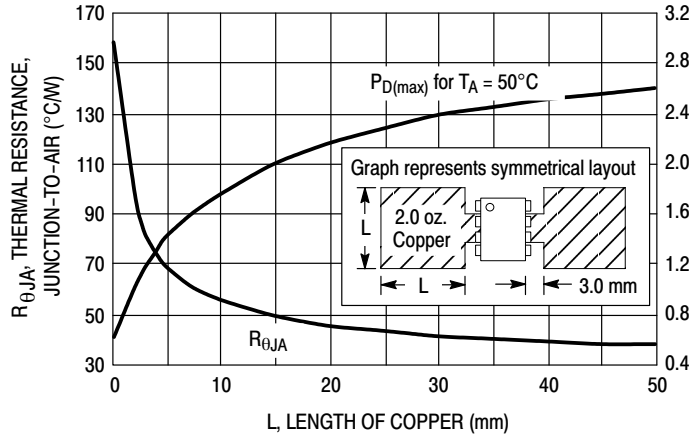

Figure 8. SOP-8 Thermal Resistance and Maximum Power Dissipation versus P.C.B. Copper Length

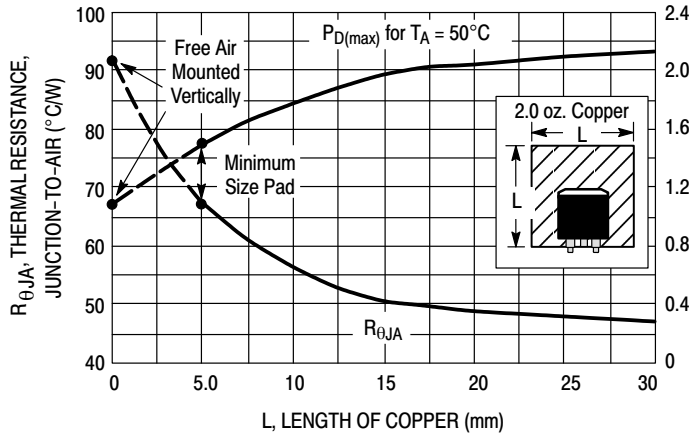

Figure 9. DPAK Thermal Resistance and Maximum Power Dissipation versus P.C.B. Copper Length

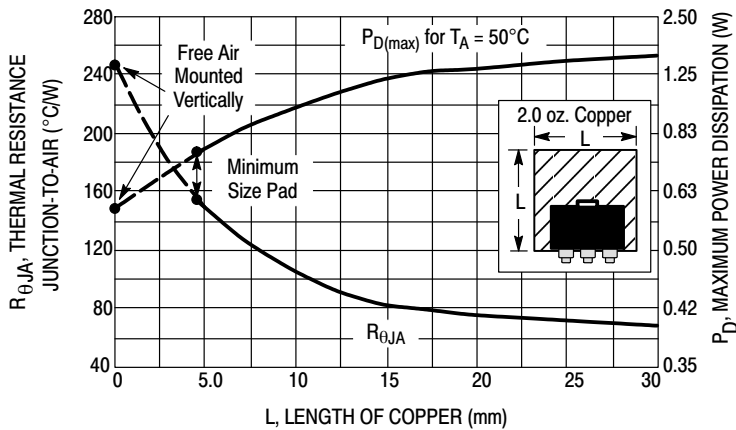

Figure 10. SOT-223 Thermal Resistance and Maximum Power Dissipation versus P.C.B. Copper Length

APPLICATIONS INFORMATION

Figures 11 through 15 are typical application circuits. The output current capability of the regulator is in excess of 800 mA, with a typical dropout voltage of less than 1.0 V. Internal protective features include current and thermal limiting.

\* The MC33269 requires an external output capacitor for stability. The capacitor should be at least 10 μF with an equivalent series resistance (ESR) of less than 10 Ω but greater than 0.2 Ω over the anticipated operating temperature range. With economical electrolytic capacitors, cold temperature operation can pose a problem. As temperature decreases, the capacitance also decreases and the ESR increases, which could cause the circuit to oscillate. Also capacitance and ESR of a solid tantalum capacitor is more stable over temperature. The use of a low ESR ceramic capacitor placed within close proximity to the output of the device could cause instability.

\*\* An input bypass capacitor is recommended to improve transient response or if the regulator is connected to the

supply input filter with long wire lengths. This will reduce the circuit's sensitivity to the input line impedance at high frequencies. A 0.33 μF or larger tantalum, mylar, ceramic, or other capacitor having low internal impedance at high frequencies should be chosen. The bypass capacitor should be mounted with shortest possible lead or track length directly across the regulator's input terminals. **Applications should be tested over all operating conditions to insure stability.**

Internal thermal limiting circuitry is provided to protect the integrated circuit in the event that the maximum junction temperature is exceeded. When activated, typically at 170°C, the output is disabled. There is no hysteresis built into the thermal limiting circuit. As a result, if the device is overheating, the output will appear to be oscillating. This feature is provided to prevent catastrophic failures from accidental device overheating. **It is not intended to be used as a substitute for proper heat-sinking.**

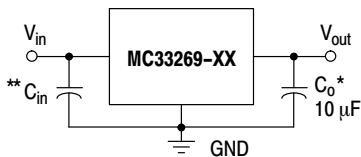

An input capacitor is not necessary for stability, however it will improve the overall performance.

Figure 11. Typical Fixed Output Application

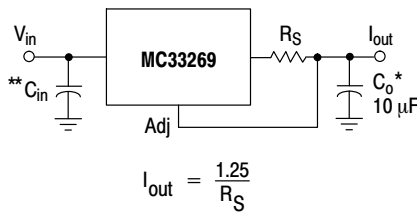

$$I_{out} = \frac{1.25}{R_S}$$

Figure 13. Current Regulator

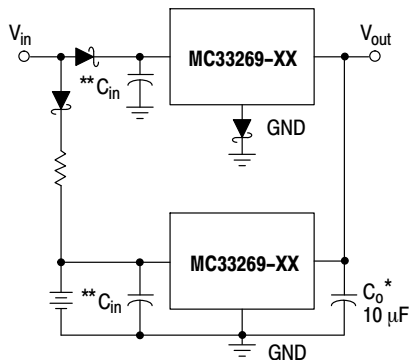

The Schottky diode in series with the ground leg of the upper regulator shifts its output voltage higher by the forward voltage drop of the diode. This will cause the lower device to remain off until the input voltage is removed.

Figure 14. Battery Backed-Up Power Supply

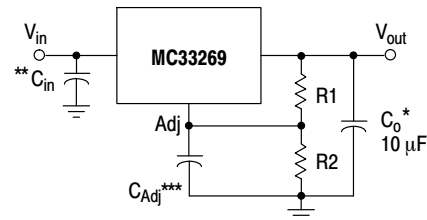

$$V_{out} = 1.25 \left( 1 + \frac{R2}{R1} \right) + I_{Adj} R2$$

\*\*\*C<sub>Adj</sub> is optional, however it will improve the ripple rejection. The MC34269 develops a 1.25 V reference voltage between the output and the adjust terminal. Resistor R1, operates with constant current to flow through it and resistor R2. This current should be set such that the Adjust Pin current causes negligible drop across resistor R2. The total current with minimum load should be greater than 8.0 mA.

Figure 12. Typical Adjustable Output Application

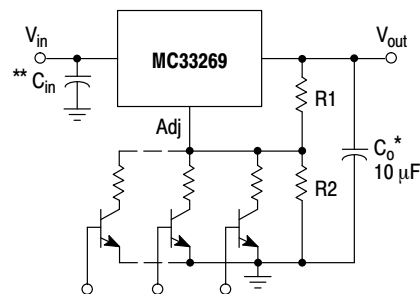

R<sub>2</sub> sets the maximum output voltage. Each transistor reduces the output voltage when turned on.

Figure 15. Digitally Controlled Voltage Regulator

## MC33269, NCV33269

### ORDERING INFORMATION

Device	Package	Shipping Information†
MC33269DG	SO-8 (Pb-Free)	98 Units / Rail
MC33269DR2G	SO-8 (Pb-Free)	2500 Units / Tape & Reel
MC33269DTG	DPAK (Pb-Free)	75 Units / Rail
MC33269DTRKG	DPAK (Pb-Free)	2500 Units / Tape & Reel
MC33269TG	TO-220 (Pb-Free)	50 Units / Rail
MC33269D-3.3G	SO-8 (Pb-Free)	98 Units / Rail
MC33269DR2-3.3G	SO-8 (Pb-Free)	2500 Units / Tape & Reel
MC33269DT-3.3G	DPAK (Pb-Free)	75 Units / Rail
MC33269DTRK-3.3G	DPAK (Pb-Free)	2500 Units / Tape & Reel
MC33269ST-3.3T3G	SOT-223 (Pb-Free)	4000 Units / Tape & Reel
MC33269T-3.3G	TO-220 (Pb-Free)	50 Units / Rail
MC33269D-5.0G	SO-8 (Pb-Free)	98 Units / Rail
MC33269DR2-5.0G	SO-8 (Pb-Free)	2500 Units / Tape & Reel
MC33269DT-5.0G	DPAK (Pb-Free)	75 Units / Rail
NCV33269DT-5.0G*	DPAK (Pb-Free)	75 Units / Rail
MC33269DTRK-5.0G	DPAK (Pb-Free)	2500 Units / Tape & Reel
MC33269T-5.0G	TO-220 (Pb-Free)	50 Units / Rail
MC33269D-012G	SO-8 (Pb-Free)	98 Units / Rail
MC33269DR2-012G	SO-8 (Pb-Free)	2500 Units / Tape & Reel
MC33269DT-012G	DPAK (Pb-Free)	75 Units / Rail
MC33269DTRK-012G	DPAK (Pb-Free)	2500 Units / Tape & Reel
MC33269T-012G	TO-220 (Pb-Free)	50 Units / Rail
NCV33269DR2G*	SO-8 (Pb-Free)	2500 Units / Tape & Reel
NCV33269DTRKG*	DPAK (Pb-Free)	2500 Units / Tape & Reel
NCV33269DTRK3.3G*	DPAK (Pb-Free)	2500 Units / Tape & Reel
NCV33269DTRK5.0G*	DPAK (Pb-Free)	2500 Units / Tape & Reel
NCV33269DTRK-12G*	DPAK (Pb-Free)	2500 Units / Tape & Reel

†For information on tape and reel specifications, including part orientation and tape sizes, please refer to our Tape and Reel Packaging Specifications Brochure, BRD8011/D.

\*NCV Prefix for Automotive and Other Applications Requiring Unique Site and Control Change Requirements; AEC-Q100 Qualified and PPAP Capable.

# MC33269, NCV33269

## MARKING DIAGRAMS

### SO-8 D SUFFIX CASE 751

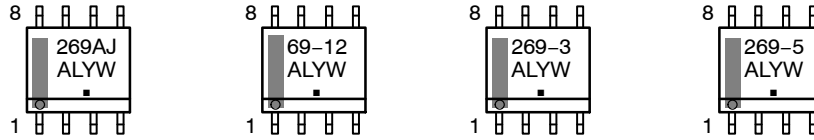

### DPAK DT SUFFIX CASE 369C

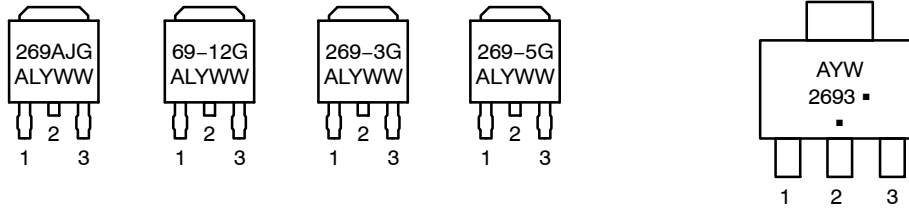

### TO-220AB T SUFFIX CASE 221A

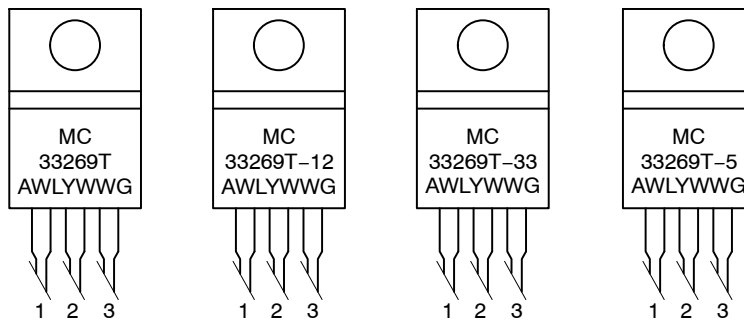

A = Assembly Location  
 L, WL = Wafer Lot  
 Y = Year  
 W, WW = Work Week  
 G = Pb-Free Package  
 ■ = Pb-Free Package  
 (Note: Microdot may be in either location)



# MC33269, NCV33269

## PACKAGE DIMENSIONS

SO-8  
D SUFFIX  
CASE 751-07  
ISSUE AK

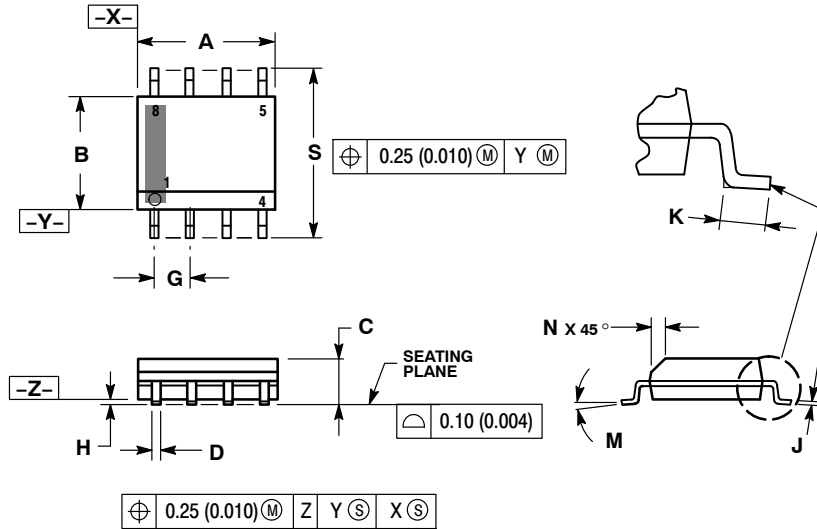

NOTES:

1. DIMENSIONING AND TOLERANCING PER ANSI Y14.5M, 1982.
2. CONTROLLING DIMENSION: MILLIMETER.
3. DIMENSION A AND B DO NOT INCLUDE MOLD PROTRUSION.
4. MAXIMUM MOLD PROTRUSION 0.15 (0.006) PER SIDE.
5. DIMENSION D DOES NOT INCLUDE DAMBAR PROTRUSION. ALLOWABLE DAMBAR PROTRUSION SHALL BE 0.127 (0.005) TOTAL IN EXCESS OF THE D DIMENSION AT MAXIMUM MATERIAL CONDITION.
6. 751-01 THRU 751-06 ARE OBSOLETE. NEW STANDARD IS 751-07.

DIM	MILLIMETERS		INCHES	
	MIN	MAX	MIN	MAX
A	4.80	5.00	0.189	0.197
B	3.80	4.00	0.150	0.157
C	1.35	1.75	0.053	0.069
D	0.33	0.51	0.013	0.020
G	1.27 BSC		0.050 BSC	
H	0.10	0.25	0.004	0.010
J	0.19	0.25	0.007	0.010
K	0.40	1.27	0.016	0.050
M	0°	8°	0°	8°
N	0.25	0.50	0.010	0.020
S	5.80	6.20	0.228	0.244

### SOLDERING FOOTPRINT\*

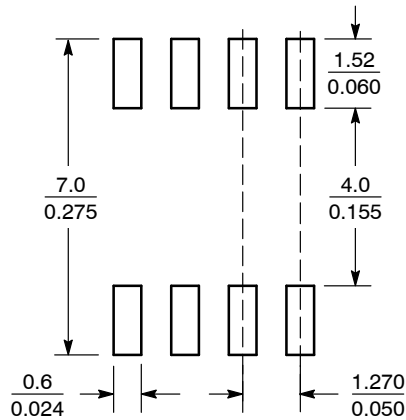

SCALE 6:1 ( $\frac{\text{mm}}{\text{inches}}$ )

\*For additional information on our Pb-Free strategy and soldering details, please download the ON Semiconductor Soldering and Mounting Techniques Reference Manual, SOLDERRM/D.

# MC33269, NCV33269

## PACKAGE DIMENSIONS

DPAK  
DT SUFFIX  
CASE 369C  
ISSUE D

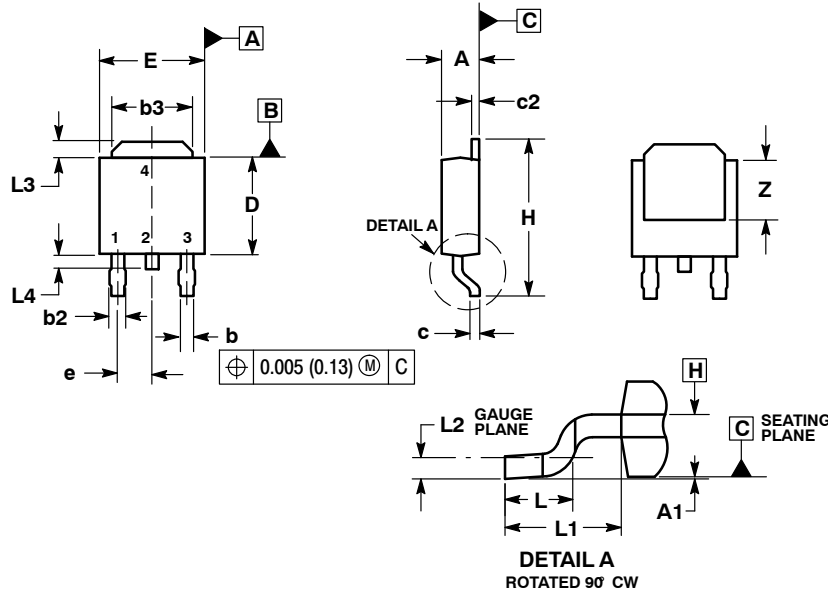

NOTES:

1. DIMENSIONING AND TOLERANCING PER ASME Y14.5M, 1994.
2. CONTROLLING DIMENSION: INCHES.
3. THERMAL PAD CONTOUR OPTIONAL WITHIN DIMENSIONS b3, L3 and Z.
4. DIMENSIONS D AND E DO NOT INCLUDE MOLD FLASH, PROTRUSIONS, OR BURRS. MOLD FLASH, PROTRUSIONS, OR GATE BURRS SHALL NOT EXCEED 0.006 INCHES PER SIDE.
5. DIMENSIONS D AND E ARE DETERMINED AT THE OUTERMOST EXTREMES OF THE PLASTIC BODY.
6. DATUMS A AND B ARE DETERMINED AT DATUM PLANE H.

DIM	INCHES		MILLIMETERS	
	MIN	MAX	MIN	MAX
A	0.086	0.094	2.18	2.38
A1	0.000	0.005	0.00	0.13
b	0.025	0.035	0.63	0.89
b2	0.030	0.045	0.76	1.14
b3	0.180	0.215	4.57	5.46
c	0.018	0.024	0.46	0.61
c2	0.018	0.024	0.46	0.61
D	0.235	0.245	5.97	6.22
E	0.250	0.265	6.35	6.73
e	0.090 BSC		2.29 BSC	
H	0.370	0.410	9.40	10.41
L	0.055	0.070	1.40	1.78
L1	0.108 REF		2.74 REF	
L2	0.020 BSC		0.51 BSC	
L3	0.035	0.050	0.89	1.27
L4	---	0.040	---	1.01
Z	0.155	---	3.93	---

### SOLDERING FOOTPRINT\*

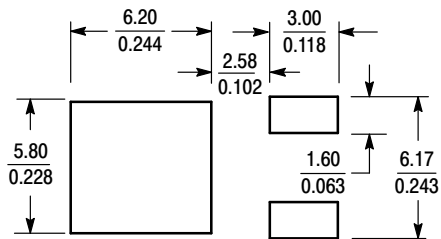

SCALE 3:1  $\left(\frac{\text{mm}}{\text{inches}}\right)$

\*For additional information on our Pb-Free strategy and soldering details, please download the ON Semiconductor Soldering and Mounting Techniques Reference Manual, SOLDERRM/D.

# MC33269, NCV33269

## PACKAGE DIMENSIONS

SOT-223  
ST SUFFIX  
CASE 318E-04  
ISSUE N

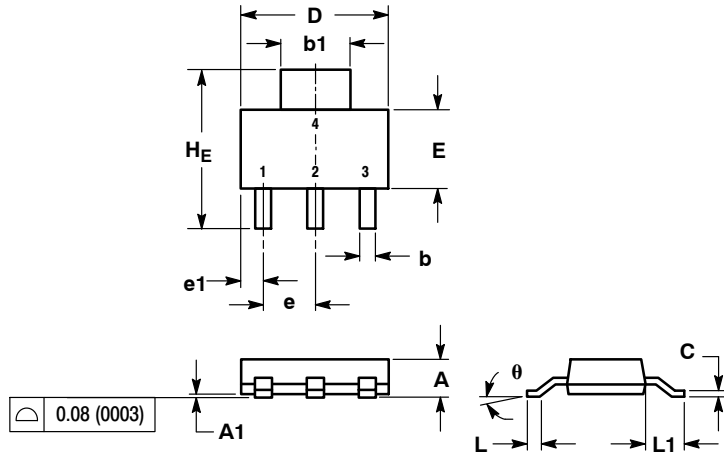

NOTES:  
1. DIMENSIONING AND TOLERANCING PER ANSI Y14.5M, 1982.  
2. CONTROLLING DIMENSION: INCH.

DIM	MILLIMETERS			INCHES		
	MIN	NOM	MAX	MIN	NOM	MAX
A	1.50	1.63	1.75	0.060	0.064	0.068
A1	0.02	0.06	0.10	0.001	0.002	0.004
b	0.60	0.75	0.89	0.024	0.030	0.035
b1	2.90	3.06	3.20	0.115	0.121	0.126
c	0.24	0.29	0.35	0.009	0.012	0.014
D	6.30	6.50	6.70	0.249	0.256	0.263
E	3.30	3.50	3.70	0.130	0.138	0.145
e	2.20	2.30	2.40	0.087	0.091	0.094
e1	0.85	0.94	1.05	0.033	0.037	0.041
L	0.20	---	---	0.008	---	---
L1	1.50	1.75	2.00	0.060	0.069	0.078
HE	6.70	7.00	7.30	0.264	0.276	0.287
theta	0°	-	10°	0°	-	10°

### SOLDERING FOOTPRINT\*

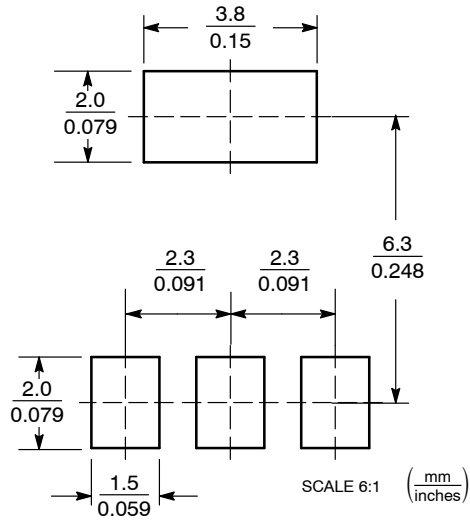

\*For additional information on our Pb-Free strategy and soldering details, please download the ON Semiconductor Soldering and Mounting Techniques Reference Manual, SOLDERRM/D.

# MC33269, NCV33269

## PACKAGE DIMENSIONS

TO-220, SINGLE GAUGE  
T SUFFIX  
CASE 221AB  
ISSUE A

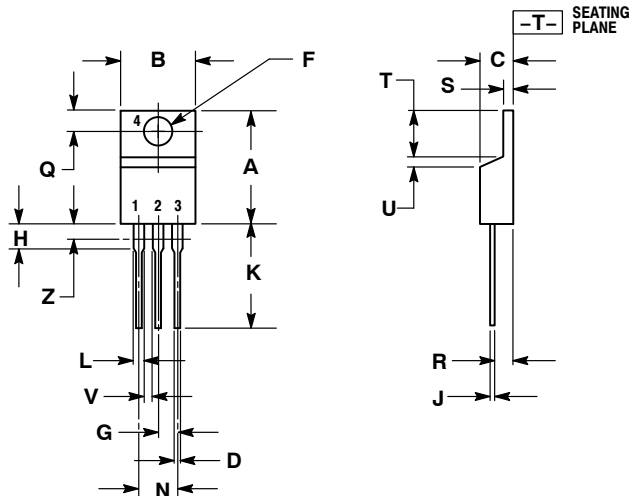

NOTES:

1. DIMENSIONING AND TOLERANCING PER ANSI Y14.5M, 1982.
2. CONTROLLING DIMENSION: INCHES.
3. DIMENSION Z DEFINES A ZONE WHERE ALL BODY AND LEAD IRREGULARITIES ARE ALLOWED.
4. PRODUCT SHIPPED PRIOR TO 2008 HAD DIMENSIONS S = 0.045 - 0.055 INCHES (1.143 - 1.397 MM)

DIM	INCHES		MILLIMETERS	
	MIN	MAX	MIN	MAX
A	0.570	0.620	14.48	15.75
B	0.380	0.405	9.66	10.28
C	0.160	0.190	4.07	4.82
D	0.025	0.035	0.64	0.88
F	0.142	0.147	3.61	3.73
G	0.095	0.105	2.42	2.66
H	0.110	0.155	2.80	3.93
J	0.018	0.025	0.46	0.64
K	0.500	0.562	12.70	14.27
L	0.045	0.060	1.15	1.52
N	0.190	0.210	4.83	5.33
Q	0.100	0.120	2.54	3.04
R	0.080	0.110	2.04	2.79
S	0.020	0.024	0.508	0.61
T	0.235	0.255	5.97	6.47
U	0.000	0.050	0.00	1.27
V	0.045	---	1.15	---
Z	---	0.080	---	2.04

ON Semiconductor and are registered trademarks of Semiconductor Components Industries, LLC (SCILLC). SCILLC owns the rights to a number of patents, trademarks, copyrights, trade secrets, and other intellectual property. A listing of SCILLC's product/patent coverage may be accessed at [www.onsemi.com/site/pdf/Patent-Marking.pdf](http://www.onsemi.com/site/pdf/Patent-Marking.pdf). SCILLC reserves the right to make changes without further notice to any products herein. SCILLC makes no warranty, representation or guarantee regarding the suitability of its products for any particular purpose, nor does SCILLC assume any liability arising out of the application or use of any product or circuit, and specifically disclaims any and all liability, including without limitation special, consequential or incidental damages. "Typical" parameters which may be provided in SCILLC data sheets and/or specifications can and do vary in different applications and actual performance may vary over time. All operating parameters, including "Typicals" must be validated for each customer application by customer's technical experts. SCILLC does not convey any license under its patent rights nor the rights of others. SCILLC products are not designed, intended, or authorized for use as components in systems intended for surgical implant into the body, or other applications intended to support or sustain life, or for any other application in which the failure of the SCILLC product could create a situation where personal injury or death may occur. Should Buyer purchase or use SCILLC products for any such unintended or unauthorized application, Buyer shall indemnify and hold SCILLC and its officers, employees, subsidiaries, affiliates, and distributors harmless against all claims, costs, damages, and expenses, and reasonable attorney fees arising out of, directly or indirectly, any claim of personal injury or death associated with such unintended or unauthorized use, even if such claim alleges that SCILLC was negligent regarding the design or manufacture of the part. SCILLC is an Equal Opportunity/Affirmative Action Employer. This literature is subject to all applicable copyright laws and is not for resale in any manner.

### PUBLICATION ORDERING INFORMATION

**LITERATURE FULFILLMENT:**

Literature Distribution Center for ON Semiconductor  
P.O. Box 5163, Denver, Colorado 80217 USA  
Phone: 303-675-2175 or 800-344-3860 Toll Free USA/Canada  
Fax: 303-675-2176 or 800-344-3867 Toll Free USA/Canada  
Email: [orderlit@onsemi.com](mailto:orderlit@onsemi.com)

**N. American Technical Support:** 800-282-9855 Toll Free  
USA/Canada  
**Europe, Middle East and Africa Technical Support:**  
Phone: 421 33 790 2910  
**Japan Customer Focus Center**  
Phone: 81-3-5817-1050

**ON Semiconductor Website:** [www.onsemi.com](http://www.onsemi.com)

**Order Literature:** <http://www.onsemi.com/orderlit>

For additional information, please contact your local Sales Representative