

# MJE200 - NPN, MJE210 - PNP

Preferred Device

## Complementary Silicon Power Plastic Transistors

These devices are designed for low voltage, low-power, high-gain audio amplifier applications.

### Features

- Collector-Emitter Sustaining Voltage -  
 $V_{CEO(sus)} = 25 \text{ Vdc (Min) @ } I_C = 10 \text{ mAdc}$
- High DC Current Gain -  
 $h_{FE} = 70 \text{ (Min) @ } I_C = 500 \text{ mAdc}$   
 $= 45 \text{ (Min) @ } I_C = 2.0 \text{ Adc}$   
 $= 10 \text{ (Min) @ } I_C = 5.0 \text{ Adc}$
- Low Collector-Emitter Saturation Voltage -  
 $V_{CE(sat)} = 0.3 \text{ Vdc (Max) @ } I_C = 500 \text{ mAdc}$   
 $= 0.75 \text{ Vdc (Max) @ } I_C = 2.0 \text{ Adc}$
- High Current-Gain - Bandwidth Product -  
 $f_T = 65 \text{ MHz (Min) @ } I_C$   
 $= 100 \text{ mAdc}$
- Annular Construction for Low Leakage -  
 $I_{CBO} = 100 \text{ nAdc @ Rated } V_{CB}$
- Pb-Free Packages are Available\*

### MAXIMUM RATINGS

Rating	Symbol	Value	Unit
Collector-Emitter Voltage	$V_{CEO}$	40	Vdc
Collector-Base Voltage	$V_{CB}$	25	Vdc
Emitter-Base Voltage	$V_{EB}$	8.0	Vdc
Collector Current - Continuous - Peak	$I_C$	5.0 10	Adc
Base Current	$I_B$	1.0	Adc
Total Power Dissipation @ $T_C = 25^\circ\text{C}$ Derate above $25^\circ\text{C}$	$P_D$	15 0.12	W mW/ $^\circ\text{C}$
Total Power Dissipation @ $T_C = 25^\circ\text{C}$ Derate above $25^\circ\text{C}$	$P_D$	1.5 0.012	W mW/ $^\circ\text{C}$
Operating and Storage Junction Temperature Range	$T_J, T_{stg}$	-65 to +150	$^\circ\text{C}$

### THERMAL CHARACTERISTICS

Characteristic	Symbol	Max	Unit
Thermal Resistance, Junction-to-Case	$\theta_{JC}$	8.34	$^\circ\text{C/W}$
Thermal Resistance, Junction-to-Ambient	$\theta_{JA}$	83.4	$^\circ\text{C/W}$

Stresses exceeding Maximum Ratings may damage the device. Maximum Ratings are stress ratings only. Functional operation above the Recommended Operating Conditions is not implied. Extended exposure to stresses above the Recommended Operating Conditions may affect device reliability.

\*For additional information on our Pb-Free strategy and soldering details, please download the ON Semiconductor Soldering and Mounting Techniques Reference Manual, SOLDERRM/D.



ON Semiconductor®

<http://onsemi.com>

**5.0 AMPERES  
POWER TRANSISTORS  
COMPLEMENTARY SILICON  
25 VOLTS, 15 WATTS**

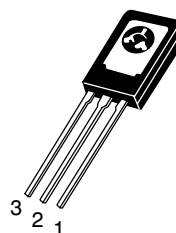

TO-225  
CASE 77  
STYLE 1

### MARKING DIAGRAM

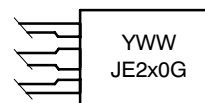

Y = Year  
WW = Work Week  
JE2x0 = Device Code  
x = 0 or 1  
G = Pb-Free Package

### ORDERING INFORMATION

Device	Package	Shipping
MJE200	TO-225	500 Units/Box
MJE200G	TO-225 (Pb-Free)	500 Units/Box
MJE210	TO-225	500 Units/Box
MJE210G	TO-225 (Pb-Free)	500 Units/Box
MJE210T	TO-225	50 Units/Rail
MJE210TG	TO-225 (Pb-Free)	50 Units/Rail

Preferred devices are recommended choices for future use and best overall value.

# MJE200 – NPN,      MJE210 – PNP

## ELECTRICAL CHARACTERISTICS (T<sub>C</sub> = 25°C unless otherwise noted)

Characteristic	Symbol	Min	Max	Unit
----------------	--------	-----	-----	------

### OFF CHARACTERISTICS

Collector-Emitter Sustaining Voltage (Note 1) (I <sub>C</sub> = 10 mA, I <sub>B</sub> = 0)	V <sub>CEO(sus)</sub>	25	-	Vdc
Collector Cutoff Current (V <sub>CB</sub> = 40 Vdc, I <sub>E</sub> = 0) (V <sub>CB</sub> = 40 Vdc, I <sub>E</sub> = 0, T <sub>J</sub> = 125°C)	I <sub>CBO</sub>	-	100	nAdc
		-	100	μAdc
Emitter Cutoff Current (V <sub>BE</sub> = 8.0 Vdc, I <sub>C</sub> = 0)	I <sub>EBO</sub>	-	100	nAdc

### ON CHARACTERISTICS

DC Current Gain (Note 1) (I <sub>C</sub> = 500 mA, V <sub>CE</sub> = 1.0 Vdc) (I <sub>C</sub> = 2.0 Adc, V <sub>CE</sub> = 1.0 Vdc) (I <sub>C</sub> = 5.0 Adc, V <sub>CE</sub> = 2.0 Vdc)	h <sub>FE</sub>	70	-	-
		45	180	
		10	-	
Collector-Emitter Saturation Voltage (Note 1) (I <sub>C</sub> = 500 mA, I <sub>B</sub> = 50 mA) (I <sub>C</sub> = 2.0 Adc, I <sub>B</sub> = 200 mA) (I <sub>C</sub> = 5.0 Adc, I <sub>B</sub> = 1.0 Adc)	V <sub>CE(sat)</sub>	-	0.3	Vdc
		-	0.75	
		-	1.8	
Base-Emitter Saturation Voltage (Note 1) (I <sub>C</sub> = 5.0 Adc, I <sub>B</sub> = 1.0 Adc)	V <sub>BE(sat)</sub>	-	2.5	Vdc
Base-Emitter On Voltage (Note 1) (I <sub>C</sub> = 2.0 Adc, V <sub>CE</sub> = 1.0 Vdc)	V <sub>BE(on)</sub>	-	1.6	Vdc

### DYNAMIC CHARACTERISTICS

Current-Gain – Bandwidth Product (Note 2) (I <sub>C</sub> = 100 mA, V <sub>CE</sub> = 10 Vdc, f <sub>test</sub> = 10 MHz)	f <sub>T</sub>	65	-	MHz
Output Capacitance (V <sub>CB</sub> = 10 Vdc, I <sub>E</sub> = 0, f = 0.1 MHz)	C <sub>ob</sub>	-	80	pF
		MJE200 MJE210	-	120

1. Pulse Test: Pulse Width = 300 μs, Duty Cycle ≈ 2.0%.
2. f<sub>T</sub> = |h<sub>FE</sub>| • f<sub>test</sub>.

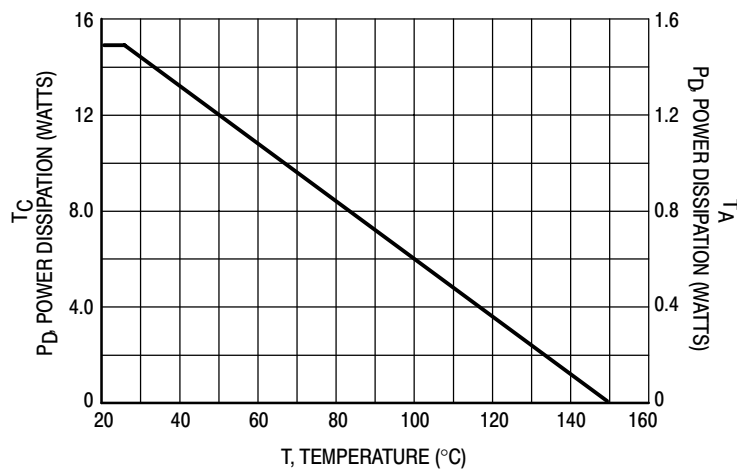

**Figure 1. Power Derating**

**MJE200 - NPN,**

**MJE210 - PNP**

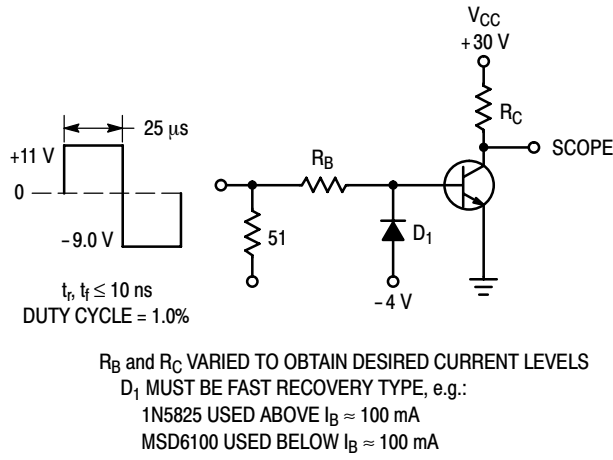

**Figure 2. Switching Time Test Circuit**

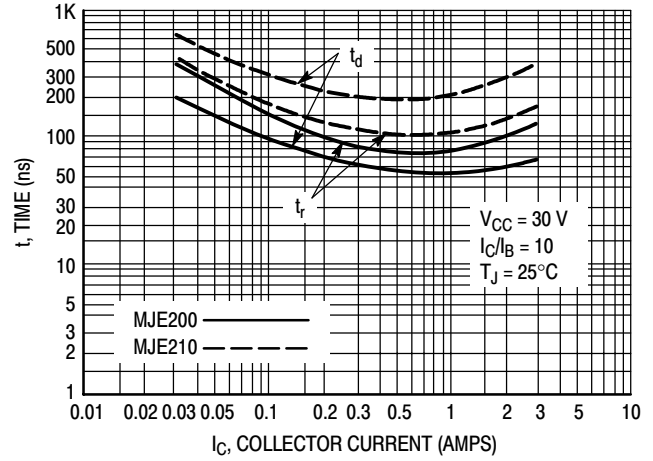

**Figure 3. Turn-On Time**

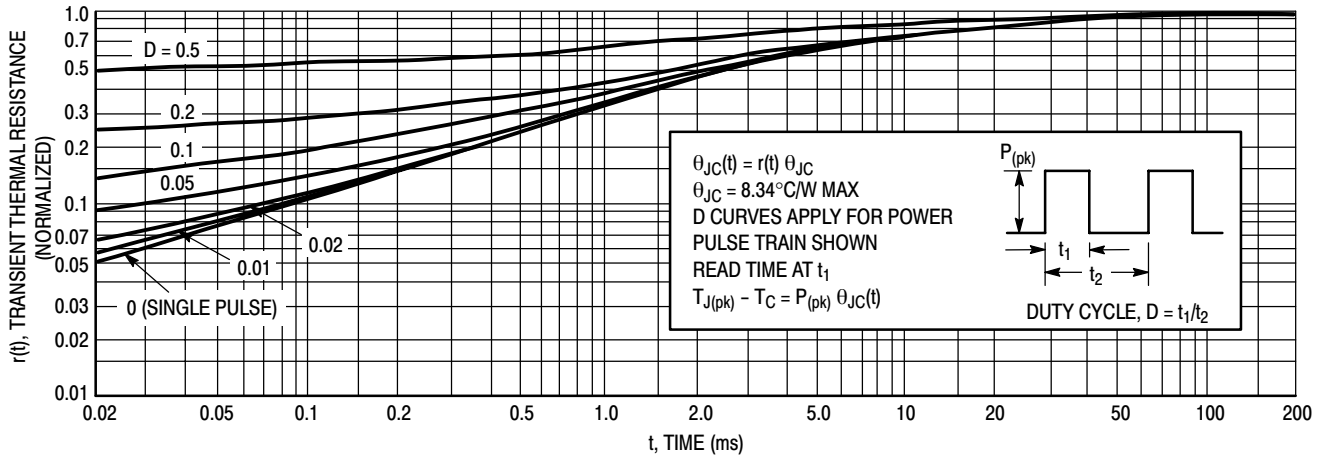

**Figure 4. Thermal Response**

## MJE200 - NPN,

## MJE210 - PNP

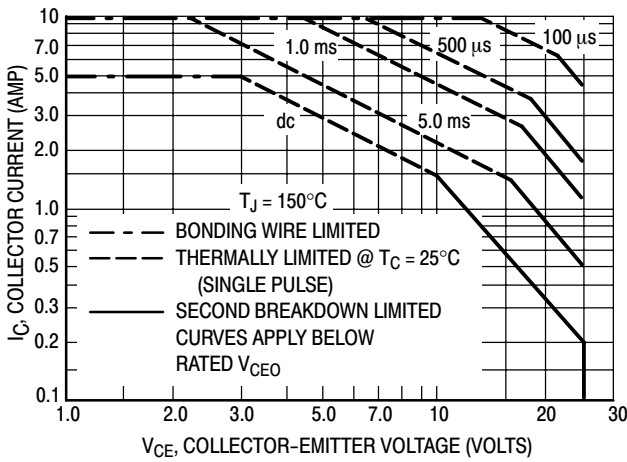

Figure 5. Active Region Safe Operating Area

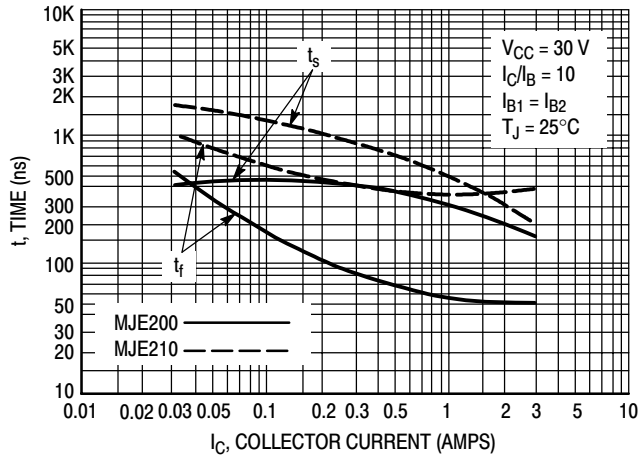

Figure 6. Turn-Off Time

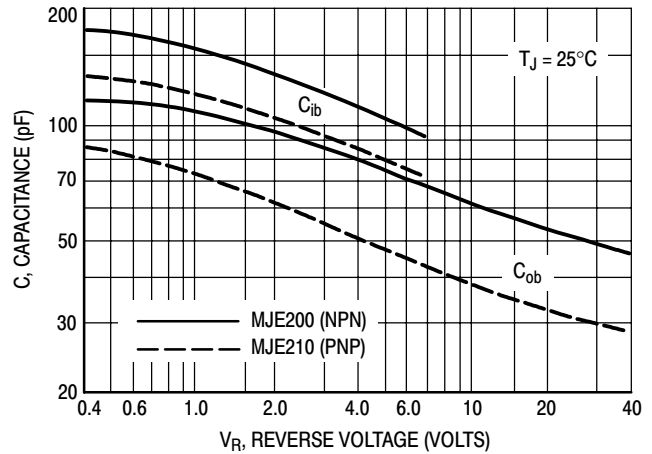

Figure 7. Capacitance

There are two limitations on the power handling ability of a transistor: average junction temperature and second breakdown. Safe operating area curves indicate  $I_C - V_{CE}$  limits of the transistor that must be observed for reliable operation; i.e., the transistor must not be subjected to greater dissipation than the curves indicate.

The data of Figure 5 is based on  $T_{J(pk)} = 150^\circ\text{C}$ ;  $T_C$  is variable depending on conditions. Second breakdown pulse limits are valid for duty cycles to 10% provided  $T_{J(pk)} \leq 150^\circ\text{C}$ .  $T_{J(pk)}$  may be calculated from the data in Figure 4. At high case temperatures, thermal limitations will reduce the power that can be handled to values less than the limitations imposed by second breakdown.

## MJE200 - NPN,

## MJE210 - PNP

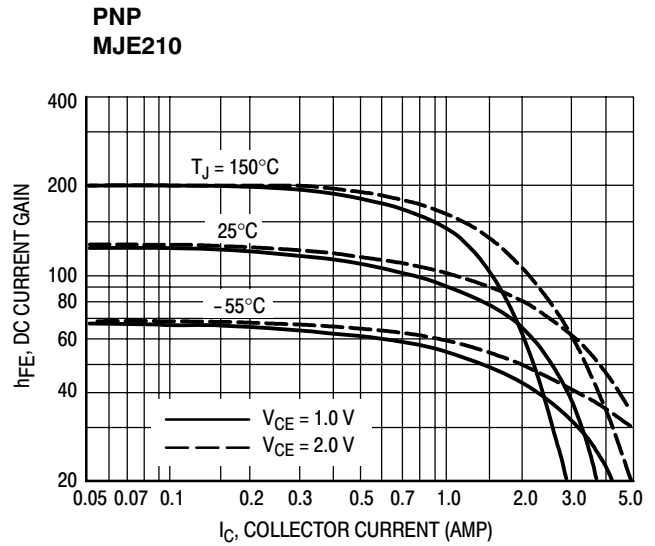
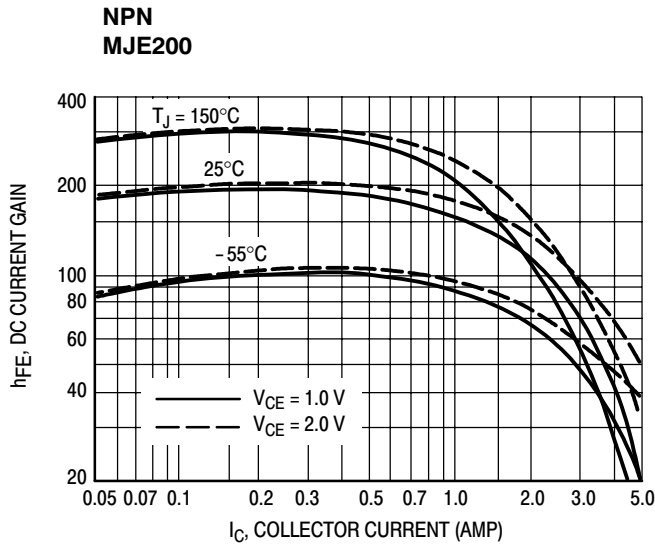

Figure 8. DC Current Gain

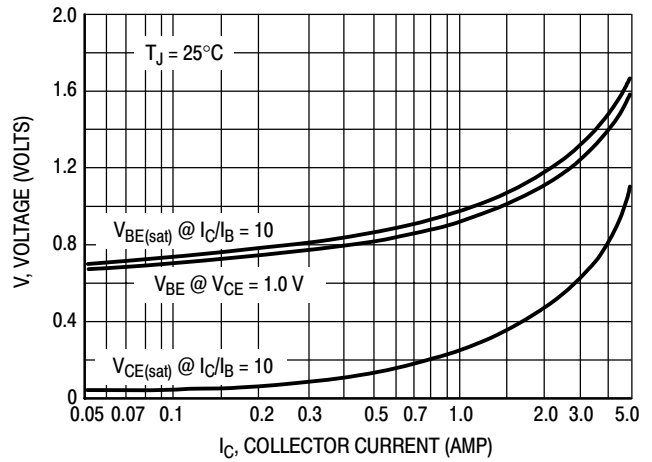
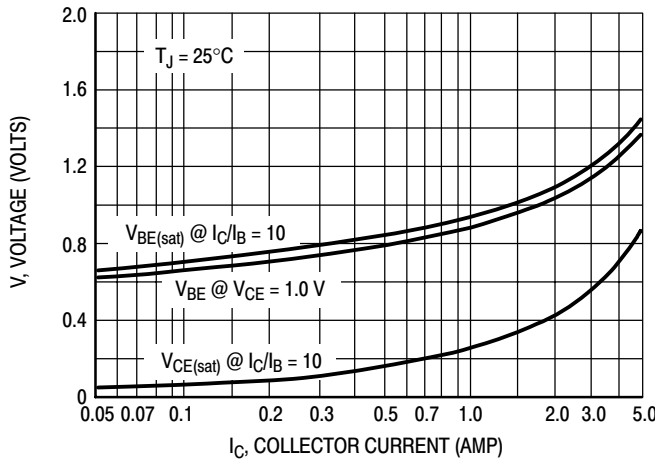

Figure 9. "On" Voltage

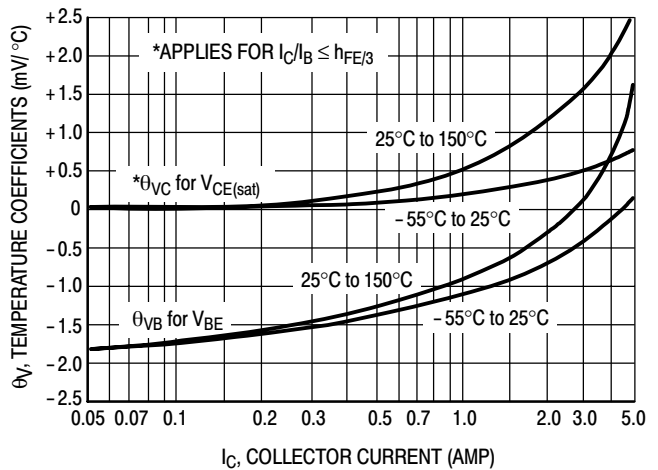
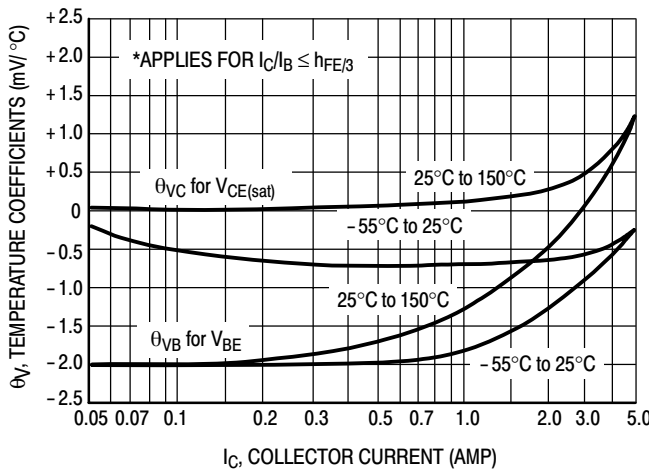
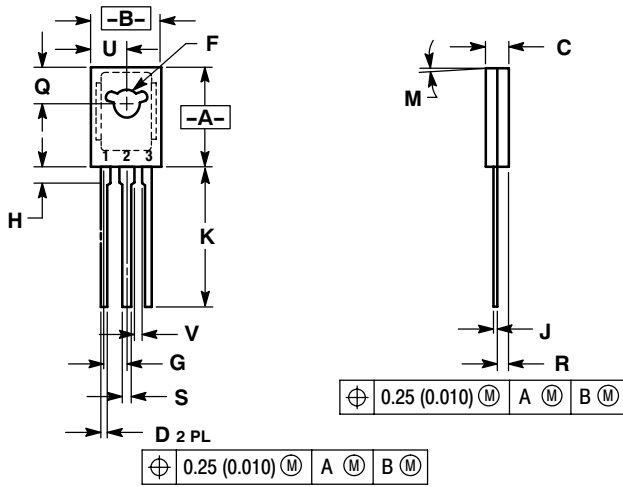

Figure 10. Temperature Coefficients

# MJE200 - NPN, MJE210 - PNP

## PACKAGE DIMENSIONS

TO-225  
CASE 77-09  
ISSUE Z



NOTES:

1. DIMENSIONING AND TOLERANCING PER ANSI Y14.5M, 1982.
2. CONTROLLING DIMENSION: INCH.
3. 077-01 THRU -08 OBSOLETE, NEW STANDARD 077-09.

DIM	INCHES		MILLIMETERS	
	MIN	MAX	MIN	MAX
A	0.425	0.435	10.80	11.04
B	0.295	0.305	7.50	7.74
C	0.095	0.105	2.42	2.66
D	0.020	0.026	0.51	0.66
F	0.115	0.130	2.93	3.30
G	0.094 BSC		2.39 BSC	
H	0.050	0.095	1.27	2.41
J	0.015	0.025	0.39	0.63
K	0.575	0.655	14.61	16.63
M	5° TYP		5° TYP	
Q	0.148	0.158	3.76	4.01
R	0.045	0.065	1.15	1.65
S	0.025	0.035	0.64	0.88
U	0.145	0.155	3.69	3.93
V	0.040	---	1.02	---

STYLE 1:

1. EMITTER
2. COLLECTOR
3. BASE

ON Semiconductor and are registered trademarks of Semiconductor Components Industries, LLC (SCILLC). SCILLC reserves the right to make changes without further notice to any products herein. SCILLC makes no warranty, representation or guarantee regarding the suitability of its products for any particular purpose, nor does SCILLC assume any liability arising out of the application or use of any product or circuit, and specifically disclaims any and all liability, including without limitation special, consequential or incidental damages. "Typical" parameters which may be provided in SCILLC data sheets and/or specifications can and do vary in different applications and actual performance may vary over time. All operating parameters, including "Typicals" must be validated for each customer application by customer's technical experts. SCILLC does not convey any license under its patent rights nor the rights of others. SCILLC products are not designed, intended, or authorized for use as components in systems intended for surgical implant into the body, or other applications intended to support or sustain life, or for any other application in which the failure of the SCILLC product could create a situation where personal injury or death may occur. Should Buyer purchase or use SCILLC products for any such unintended or unauthorized application, Buyer shall indemnify and hold SCILLC and its officers, employees, subsidiaries, affiliates, and distributors harmless against all claims, costs, damages, and expenses, and reasonable attorney fees arising out of, directly or indirectly, any claim of personal injury or death associated with such unintended or unauthorized use, even if such claim alleges that SCILLC was negligent regarding the design or manufacture of the part. SCILLC is an Equal Opportunity/Affirmative Action Employer. This literature is subject to all applicable copyright laws and is not for resale in any manner.

### PUBLICATION ORDERING INFORMATION

LITERATURE FULFILLMENT:

Literature Distribution Center for ON Semiconductor  
P.O. Box 5163, Denver, Colorado 80217 USA  
Phone: 303-675-2175 or 800-344-3860 Toll Free USA/Canada  
Fax: 303-675-2176 or 800-344-3867 Toll Free USA/Canada  
Email: [orderlit@onsemi.com](mailto:orderlit@onsemi.com)

N. American Technical Support: 800-282-9855 Toll Free  
USA/Canada  
Europe, Middle East and Africa Technical Support:  
Phone: 421 33 790 2910  
Japan Customer Focus Center  
Phone: 81-3-5773-3850

ON Semiconductor Website: [www.onsemi.com](http://www.onsemi.com)

Order Literature: <http://www.onsemi.com/orderlit>

For additional information, please contact your local Sales Representative