

NSS40301MZ4

Preferred Device

Bipolar Power Transistors 40 V, 3.0 A, Low $V_{CE(sat)}$ NPN Transistor

ON Semiconductor's e²PowerEdge family of low $V_{CE(sat)}$ transistors are surface mount devices featuring ultra low saturation voltage ($V_{CE(sat)}$) and high current gain capability. These are designed for use in low voltage, high speed switching applications where affordable efficient energy control is important.

Typical applications are DC-DC converters and power management in portable and battery powered products such as cellular and cordless phones, PDAs, computers, printers, digital cameras and MP3 players. Other applications are low voltage motor controls in mass storage products such as disc drives and tape drives. In the automotive industry they can be used in air bag deployment and in the instrument cluster. The high current gain allows e²PowerEdge devices to be driven directly from PMU's control outputs, and the Linear Gain (Beta) makes them ideal components in analog amplifiers.

- These are Pb-Free Devices



ON Semiconductor®

<http://onsemi.com>

**NPN TRANSISTOR
3.0 AMPERES
40 VOLTS, 2.0 WATTS**

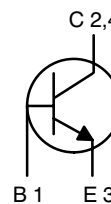

Schematic

www.BDTIC.com/ON

MARKING DIAGRAM



SOT-223
CASE 318E
STYLE 1

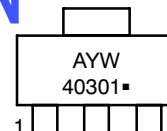

A = Assembly Location
Y = Year
W = Work Week
40301 = Specific Device Code
▪ = Pb-Free Package

PIN ASSIGNMENT

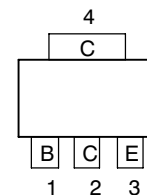

Top View Pinout

ORDERING INFORMATION

See detailed ordering and shipping information in the package dimensions section on page 2 of this data sheet.

Preferred devices are recommended choices for future use and best overall value.

NSS40301MZ4

MAXIMUM RATINGS (T_C = 25°C unless otherwise noted)

Rating	Symbol	Value	Unit
Collector-Emitter Voltage	V _{CEO}	40	Vdc
Collector-Base Voltage	V _{CB}	40	Vdc
Emitter-Base Voltage	V _{EB}	6.0	Vdc
Base Current - Continuous	I _B	1.0	Adc
Collector Current - Continuous - Peak	I _C	3.0 5.0	Adc
Total Power Dissipation Total P _D @ T _A = 25°C mounted on 1" sq. (645 sq. mm) Collector pad on FR-4 bd material Total P _D @ T _A = 25°C mounted on 0.012" sq. (7.6 sq. mm) Collector pad on FR-4 bd material	P _D	2.0 0.80	W
Operating and Storage Junction Temperature Range	T _J , T _{stg}	-55 to +150	°C

Stresses exceeding Maximum Ratings may damage the device. Maximum Ratings are stress ratings only. Functional operation above the Recommended Operating Conditions is not implied. Extended exposure to stresses above the Recommended Operating Conditions may affect device reliability.

THERMAL CHARACTERISTICS

Characteristic	Symbol	Max	Unit
Thermal Resistance, Junction-to-Case - Junction-to-Ambient on 1" sq. (645 sq. mm) Collector pad on FR-4 bd material - Junction-to-Ambient on 0.012" sq. (7.6 sq. mm) Collector pad on FR-4 bd material	R _{θJA} R _{θJA}	64 155	°C/W
Maximum Lead Temperature for Soldering Purposes, 1/8" from case for 5 seconds	T _L	260	°C

ORDERING INFORMATION

Device	Package	Shipping†
NSS40301MZ4T1G	SOT-223 (Pb-Free)	1000 / Tape & Reel
NSS40301MZ4T3G	SOT-223 (Pb-Free)	4000 / Tape & Reel

†For information on tape and reel specifications, including part orientation and tape sizes, please refer to our Tape and Reel Packaging Specifications Brochure, BRD8011/D.

NSS40301MZ4

ELECTRICAL CHARACTERISTICS ($T_C = 25^\circ\text{C}$ unless otherwise noted)

Characteristic	Symbol	Min	Typ	Max	Unit
----------------	--------	-----	-----	-----	------

OFF CHARACTERISTICS

Collector-Emitter Sustaining Voltage ($I_C = 10\text{ mA}$, $I_B = 0\text{ A}$)	$V_{CE(sus)}$	40			Vdc
Emitter-Base Voltage ($I_E = 50\text{ }\mu\text{A}$, $I_C = 0\text{ A}$)	V_{EBO}	6.0			Vdc
Collector Cutoff Current ($V_{CB} = 40\text{ Vdc}$)	I_{CBO}			100	nA
Emitter Cutoff Current ($V_{BE} = 6.0\text{ Vdc}$)	I_{EBO}			100	nA

ON CHARACTERISTICS (Note 1)

Collector-Emitter Saturation Voltage ($I_C = 0.5\text{ A}$, $I_B = 50\text{ mA}$) ($I_C = 1.0\text{ A}$, $I_B = 20\text{ mA}$) ($I_C = 3.0\text{ A}$, $I_B = 0.3\text{ A}$)	$V_{CE(sat)}$			0.050 0.100 0.200	Vdc
Base-Emitter Saturation Voltage ($I_C = 1.0\text{ A}$, $I_B = 0.1\text{ A}$)	$V_{BE(sat)}$			1.0	Vdc
Base-Emitter On Voltage ($I_C = 1.0\text{ A}$, $V_{CE} = 2.0\text{ Vdc}$)	$V_{BE(on)}$			0.9	Vdc
DC Current Gain ($I_C = 0.5\text{ A}$, $V_{CE} = 1.0\text{ Vdc}$) ($I_C = 1.0\text{ A}$, $V_{CE} = 1.0\text{ Vdc}$) ($I_C = 3.0\text{ A}$, $V_{CE} = 1.0\text{ Vdc}$)	h_{FE}	220 200 100		500	

DYNAMIC CHARACTERISTICS

Output Capacitance ($V_{CB} = 10\text{ Vdc}$, $r = 1.0\text{ MHz}$)	C_{ob}		25		pF
Input Capacitance ($V_{EB} = 5.0\text{ Vdc}$, $f = 1.0\text{ MHz}$)	C_{ib}		170		pF
Current-Gain - Bandwidth Product (Note 2) ($I_C = 500\text{ mA}$, $V_{CE} = 10\text{ V}$, $F_{test} = 1.0\text{ MHz}$)	f_T		215		MHz

1. Pulse Test: Pulse Width $\leq 300\text{ }\mu\text{s}$, Duty Cycle $\leq 2\%$.
2. $f_T = |h_{FE}| \cdot f_{test}$

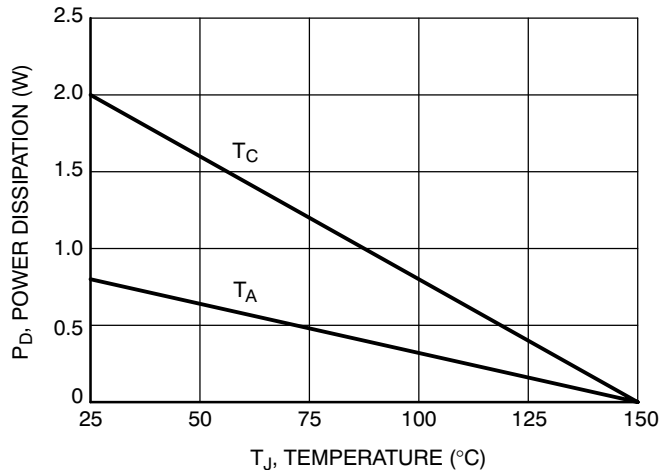

Figure 1. Power Derating

NSS40301MZ4

TYPICAL CHARACTERISTICS

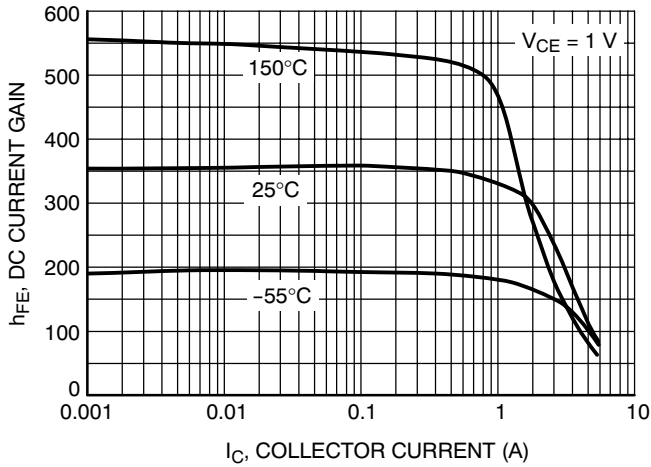

Figure 2. DC Current Gain

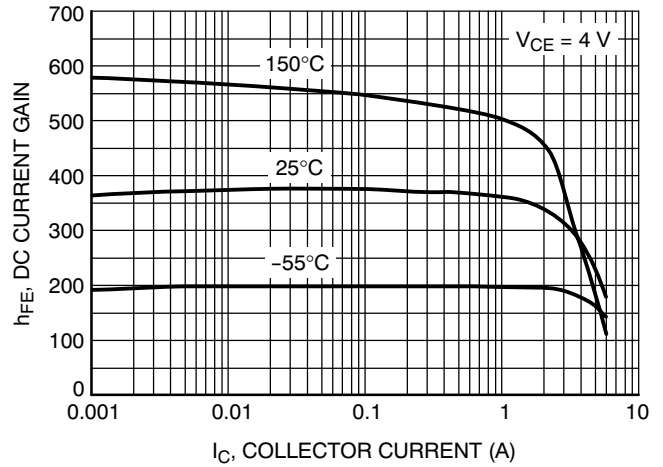

Figure 3. DC Current Gain

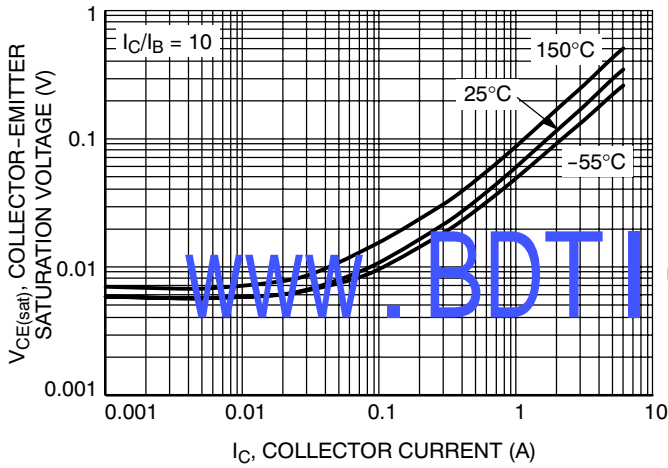

Figure 4. Collector-Emitter Saturation Voltage

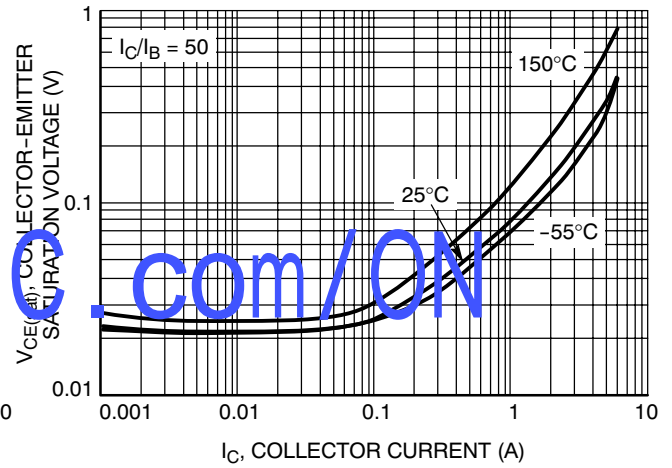

Figure 5. Collector-Emitter Saturation Voltage

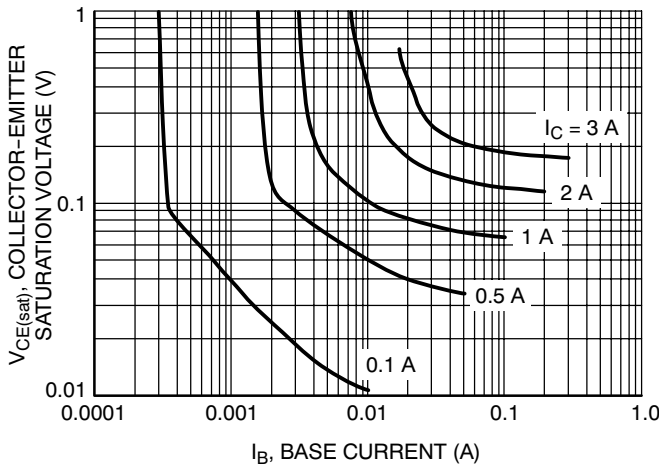

Figure 6. Collector Saturation Region

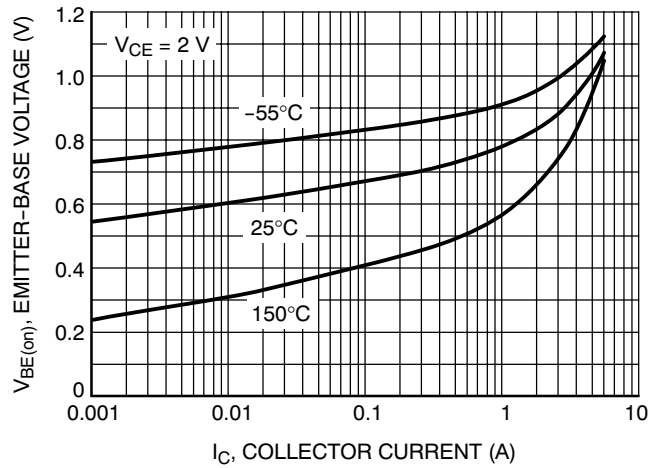

Figure 7. $V_{BE(on)}$ Voltage

TYPICAL CHARACTERISTICS

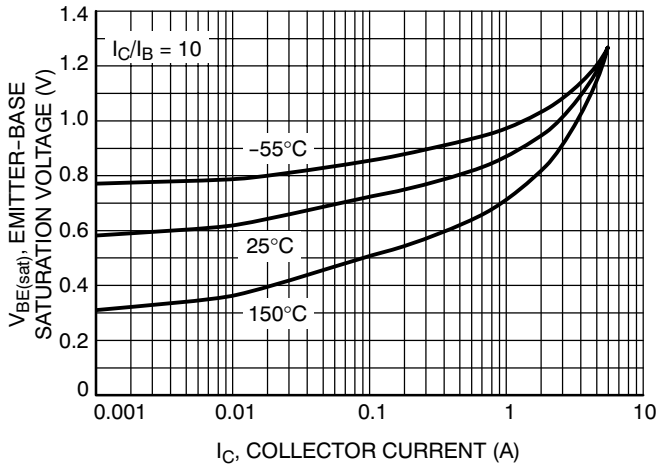

Figure 8. Base-Emitter Saturation Voltage

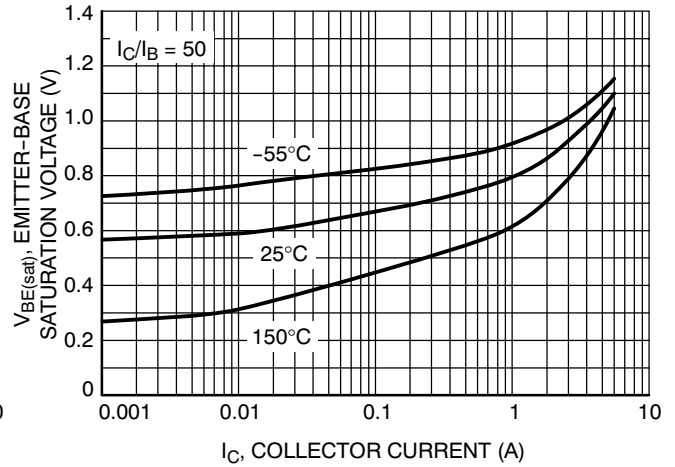

Figure 9. Base-Emitter Saturation Voltage

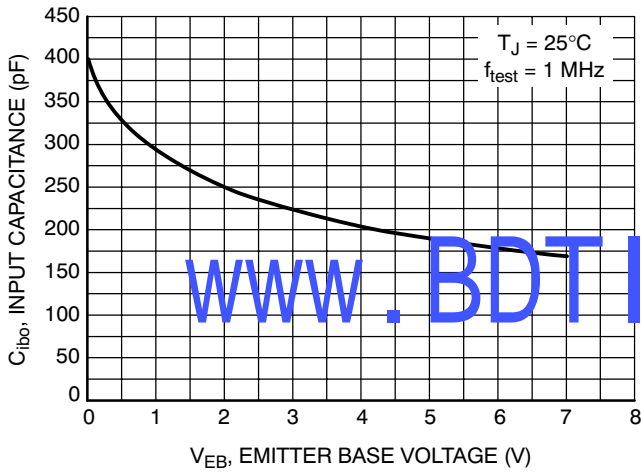

Figure 10. Input Capacitance

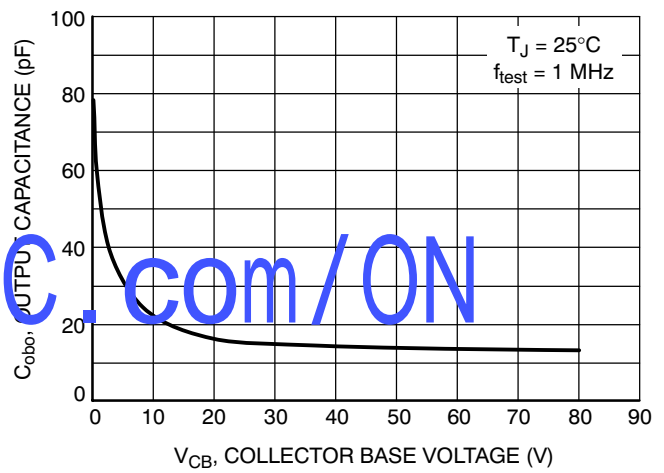

Figure 11. Output Capacitance

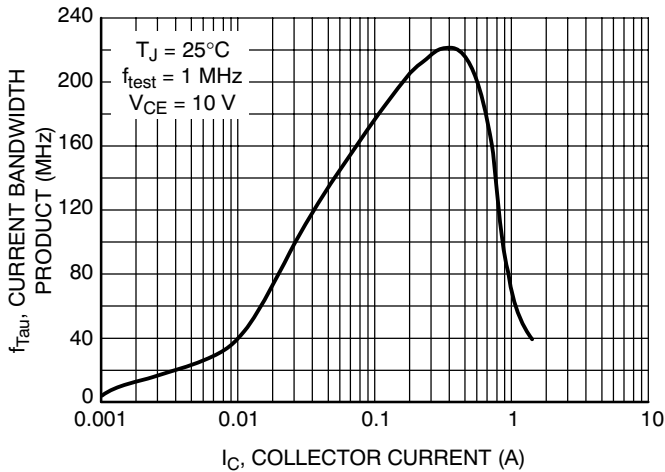

Figure 12. Current-Gain Bandwidth Product

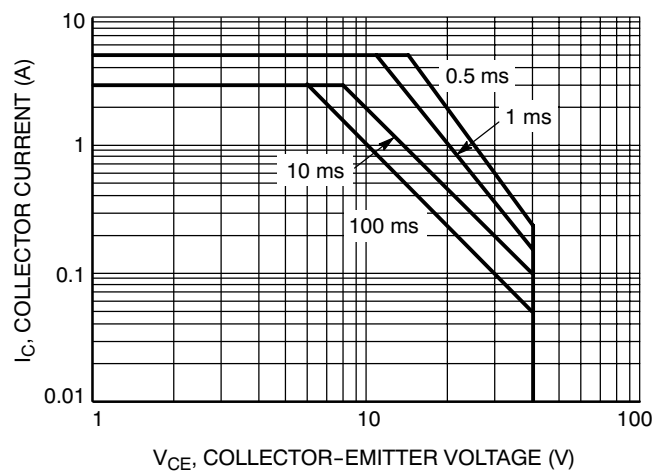
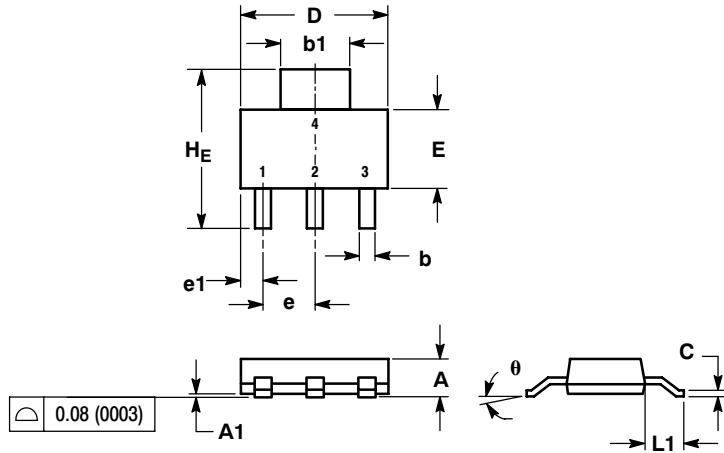

Figure 13. Safe Operating Area

NSS40301MZ4

PACKAGE DIMENSIONS

SOT-223 (TO-261)
CASE 318E-04
ISSUE L



- NOTES:
1. DIMENSIONING AND TOLERANCING PER ANSI Y14.5M, 1982.
2. CONTROLLING DIMENSION: INCH.

DIM	MILLIMETERS			INCHES		
	MIN	NOM	MAX	MIN	NOM	MAX
A	1.50	1.63	1.75	0.060	0.064	0.068
A1	0.02	0.06	0.10	0.001	0.002	0.004
b	0.60	0.75	0.89	0.024	0.030	0.035
b1	2.90	3.06	3.20	0.115	0.121	0.126
c	0.24	0.29	0.35	0.009	0.012	0.014
D	6.30	6.50	6.70	0.249	0.256	0.263
E	3.30	3.50	3.70	0.130	0.138	0.145
e	2.20	2.30	2.40	0.087	0.091	0.094
e1	0.85	0.94	1.05	0.033	0.037	0.041
L1	1.50	1.75	2.00	0.060	0.069	0.078
HE	6.70	7.00	7.30	0.264	0.276	0.287
θ	0°	-	10°	0°	-	10°

SOLDERING FOOTPRINT*

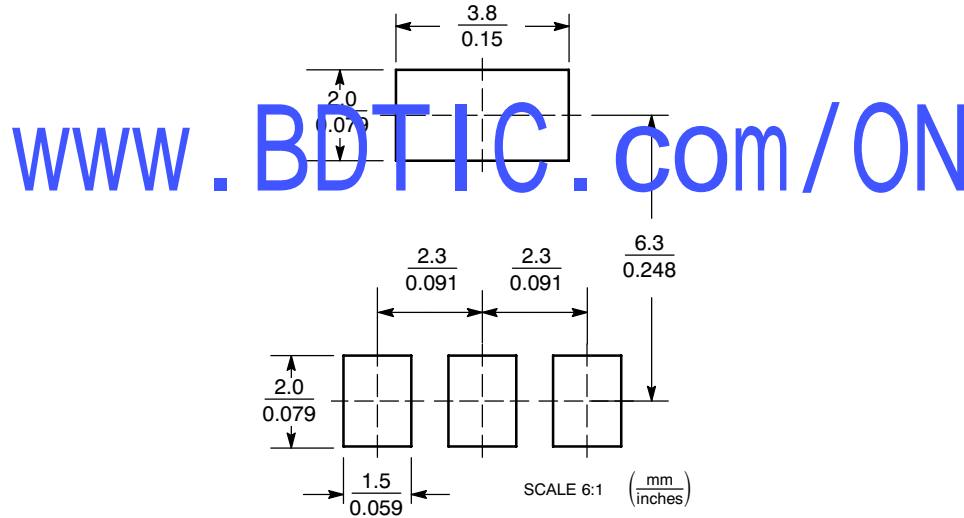

*For additional information on our Pb-Free strategy and soldering details, please download the ON Semiconductor Soldering and Mounting Techniques Reference Manual, SOLDERRM/D.

ON Semiconductor and are registered trademarks of Semiconductor Components Industries, LLC (SCILLC). SCILLC reserves the right to make changes without further notice to any products herein. SCILLC makes no warranty, representation or guarantee regarding the suitability of its products for any particular purpose, nor does SCILLC assume any liability arising out of the application or use of any product or circuit, and specifically disclaims any and all liability, including without limitation special, consequential or incidental damages. "Typical" parameters which may be provided in SCILLC data sheets and/or specifications can and do vary in different applications and actual performance may vary over time. All operating parameters, including "Typicals" must be validated for each customer application by customer's technical experts. SCILLC does not convey any license under its patent rights nor the rights of others. SCILLC products are not designed, intended, or authorized for use as components in systems intended for surgical implant into the body, or other applications intended to support or sustain life, or for any other application in which the failure of the SCILLC product could create a situation where personal injury or death may occur. Should Buyer purchase or use SCILLC products for any such unintended or unauthorized application, Buyer shall indemnify and hold SCILLC and its officers, employees, subsidiaries, affiliates, and distributors harmless against all claims, costs, damages, and expenses, and reasonable attorney fees arising out of, directly or indirectly, any claim of personal injury or death associated with such unintended or unauthorized use, even if such claim alleges that SCILLC was negligent regarding the design or manufacture of the part. SCILLC is an Equal Opportunity/Affirmative Action Employer. This literature is subject to all applicable copyright laws and is not for resale in any manner.

PUBLICATION ORDERING INFORMATION

LITERATURE FULFILLMENT:
Literature Distribution Center for ON Semiconductor
RD, Box 5163, Denver, Colorado 80217 USA
Phone: 303-675-2175 or 800-344-3860 Toll Free USA/Canada
Fax: 303-675-2176 or 800-344-3867 Toll Free USA/Canada
Email: orderlit@onsemi.com

N. American Technical Support: 800-282-9855 Toll Free
USA/Canada
Europe, Middle East and Africa Technical Support:
Phone: 421 33 790 2910
Japan Customer Focus Center
Phone: 81-3-5773-3850

ON Semiconductor Website: www.onsemi.com
Order Literature: <http://www.onsemi.com/orderlit>
For additional information, please contact your local Sales Representative