

## DDR2 Unbuffered SODIMM

200pin Unbuffered SODIMM based on 1Gb E-die  
64-bit Non-ECC

**60FBGA & 84FBGA with Lead-Free and Halogen-Free  
(RoHS compliant)**

INFORMATION IN THIS DOCUMENT IS PROVIDED IN RELATION TO SAMSUNG PRODUCTS, AND IS SUBJECT TO CHANGE WITHOUT NOTICE. NOTHING IN THIS DOCUMENT SHALL BE CONSTRUED AS GRANTING ANY LICENSE, EXPRESS OR IMPLIED, BY ESTOPPEL OR OTHERWISE, TO ANY INTELLECTUAL PROPERTY RIGHTS IN SAMSUNG PRODUCTS OR TECHNOLOGY. ALL INFORMATION IN THIS DOCUMENT IS PROVIDED ON AS "AS IS" BASIS WITHOUT GUARANTEE OR WARRANTY OF ANY KIND.

1. For updates or additional information about Samsung products, contact your nearest Samsung office.
2. Samsung products are not intended for use in life support, critical care, medical, safety equipment, or similar applications where Product failure could result in loss of life or personal or physical harm, or any military or defense application, or any governmental procurement to which special terms or provisions may apply.

\* Samsung Electronics reserves the right to change products or specification without notice.

**Table of Contents**

<b>1.0 DDR2 Unbuffered SODIMM Ordering Information</b> .....	<b>4</b>
<b>2.0 Features</b> .....	<b>4</b>
<b>3.0 Address Configuration</b> .....	<b>4</b>
<b>4.0 Pin Configurations (Front side/Back side)</b> .....	<b>5</b>
<b>5.0 Pin Description</b> .....	<b>5</b>
<b>6.0 Input/Output Function Description</b> .....	<b>6</b>
<b>7.0 Functional Block Diagram :</b> .....	<b>7</b>
7.1 2GB, 256Mx64 Module - M470T5663EH3 .....	<b>7</b>
7.2 1GB, 128Mx64 Module - M470T2864EH3 .....	<b>8</b>
7.3 1GB, 128Mx64 Module - M470T2863EH3 .....	<b>9</b>
7.4 512MB, 64Mx64 Module - M470T6464EHS.....	<b>10</b>
<b>8.0 Absolute Maximum DC Ratings</b> .....	<b>11</b>
<b>9.0 AC &amp; DC Operating Conditions</b> .....	<b>11</b>
9.1 Recommended DC Operating Conditions (SSTL - 1.8) .....	<b>11</b>
9.2 Operating Temperature Condition .....	<b>12</b>
9.3 Input DC Logic Level .....	<b>12</b>
9.4 Input AC Logic Level .....	<b>12</b>
9.5 AC Input Test Conditions .....	<b>12</b>
<b>10.0 IDD Specification Parameters Definition</b> .....	<b>13</b>
<b>11.0 Operating Current Table :</b> .....	<b>14</b>
11.1 M470T5663EH3 : 256Mx64 2GB Module .....	<b>14</b>
11.2 M470T2864EH3 : 128Mx64 1GB Module .....	<b>14</b>
11.3 M470T2863EH3: 128Mx64 1GB Module .....	<b>15</b>
11.4 M470T6464EHS: 64Mx64 512MB Module .....	<b>15</b>
<b>12.0 Input/Output Capacitance</b> .....	<b>16</b>
<b>13.0 Electrical Characteristics &amp; AC Timing for DDR2-800/667</b> .....	<b>16</b>
13.1 Refresh Parameters by Device Density .....	<b>16</b>
13.2 Speed Bins and CL, tRCD, tRP, tRC and tRAS for Corresponding Bin .....	<b>16</b>
13.3 Timing Parameters by Speed Grade .....	<b>17</b>
<b>14.0 Physical Dimensions :</b> .....	<b>19</b>
14.1 128Mbx8 based 256Mx64 Module (2 Rank) .....	<b>19</b>
14.2 64Mbx16 based 128Mx64 Module (2 Rank).....	<b>20</b>
14.3 128Mbx8 based 128Mx64 Module (1 Rank) .....	<b>21</b>
14.4 64Mbx16 based 64Mx64 Module (1 Rank).....	<b>22</b>

**Revision History**

Revision	Month	Year	History
1.0	August	2008	- Initial Release

### 1.0 DDR2 Unbuffered SODIMM Ordering Information

Part Number	Density	Organization	Component Composition	Number of Rank	Height
M470T5663EH3-C(L)E7/F7/E6	2GB	256Mx64	128Mx8(K4T1G084QE-HC(L)E7/F7/E6)*16	2	30mm
M470T2864EH3-C(L)E7/F7/E6	1GB	128Mx64	64Mx16(K4T1G164QE-HC(L)E7/F7/E6)*8	2	30mm
M470T2863EH3-C(L)E7/F7/E6	1GB	128Mx64	128Mx8(K4T1G084QE-HC(L)E7/F7/E6)*8	1	30mm
M470T6464EHS-C(L)E7/F7/E6	512MB	64Mx64	64Mx16(K4T1G164QE-HC(L)E7/F7/E6)*4	1	30mm

Note :

1. "H" of Part number(12th digit) stands for Lead-Free, Halogen-Free, and RoHS compliant products.
2. "3" of Part number(13th digit) stands for Dummy Pad PCB products.

### 2.0 Features

- Performance range

	E7 (DDR2-800)	F7 (DDR2-800)	E6 (DDR2-667)	Unit
Speed@CL3	400	-	400	Mbps
Speed@CL4	533	533	533	Mbps
Speed@CL5	800	667	667	Mbps
Speed@CL6	-	800	-	Mbps
CL-tRCD-tRP	5-5-5	6-6-6	5-5-5	CK

- JEDEC standard  $V_{DD} = 1.8V \pm 0.1V$  Power Supply
- $V_{DDQ} = 1.8V \pm 0.1V$
- 333MHz  $f_{CK}$  for 667Mb/sec/pin, 400MHz  $f_{CK}$  for 800Mb/sec/pin
- 8 Banks
- Posted  $\overline{CAS}$
- Programmable  $\overline{CAS}$  Latency: 3, 4, 5, 6
- Programmable Additive Latency: 0, 1, 2, 3, 4, 5
- Write Latency(WL) = Read Latency(RL) -1
- Burst Length: 4, 8(Interleave/Nibble sequential)
- Programmable Sequential / Interleave Burst Mode
- Bi-directional Differential Data-Strobe (Single-ended data-strobe is an optional feature)
- Off-Chip Driver(OCD) Impedance Adjustment
- On Die Termination with selectable values(50/75/150 ohms or disable)
- Average Refresh Period 7.8us at lower than a  $T_{CASE} 85^{\circ}C$ , 3.9us at  $85^{\circ}C < T_{CASE} \leq 95^{\circ}C$   
- Support High Temperature Self-Refresh rate enable feature
- Package: 60ball FBGA - 128Mx8 and 84ball FBGA - 64Mx16
- All of base components are Lead-Free, Halogen-Free, and RoHS compliant

Note : For detailed DDR2 SDRAM operation, please refer to Samsung's Device operation & Timing diagram.

### 3.0 Address Configuration

Organization	Row Address	Column Address	Bank Address	Auto Precharge
128Mx8(1Gb) based Module	A0-A13	A0-A9	BA0-BA2	A10
64Mx16(1Gb) based Module	A0-A12	A0-A9	BA0-BA2	A10

4.0 Pin Configurations (Front side/Back side)

Pin	Front	Pin	Back	Pin	Front	Pin	Back	Pin	Front	Pin	Back	Pin	Front	Pin	Back
1	V <sub>REF</sub>	2	V <sub>SS</sub>	51	DQS2	52	DM2	101	A1	102	A0	151	DQ42	152	DQ46
3	V <sub>SS</sub>	4	DQ4	53	V <sub>SS</sub>	54	V <sub>SS</sub>	103	V <sub>DD</sub>	104	V <sub>DD</sub>	153	DQ43	154	DQ47
5	DQ0	6	DQ5	55	DQ18	56	DQ22	105	A10/AP	106	BA1	155	V <sub>SS</sub>	156	V <sub>SS</sub>
7	DQ1	8	V <sub>SS</sub>	57	DQ19	58	DQ23	107	BA0	108	RAS	157	DQ48	158	DQ52
9	V <sub>SS</sub>	10	DM0	59	V <sub>SS</sub>	60	V <sub>SS</sub>	109	WE	110	S <sub>0</sub>	159	DQ49	160	DQ53
11	DQS0	12	V <sub>SS</sub>	61	DQ24	62	DQ28	111	V <sub>DD</sub>	112	V <sub>DD</sub>	161	V <sub>SS</sub>	162	V <sub>SS</sub>
13	DQS0	14	DQ6	63	DQ25	64	DQ29	113	CAS	114	ODT0	163	NC, TEST	164	CK1
15	V <sub>SS</sub>	16	DQ7	65	V <sub>SS</sub>	66	V <sub>SS</sub>	115	NC/S <sub>1</sub>	116	A13	165	V <sub>SS</sub>	166	CK1
17	DQ2	18	V <sub>SS</sub>	67	DM3	68	DQS3	117	V <sub>DD</sub>	118	V <sub>DD</sub>	167	DQS6	168	V <sub>SS</sub>
19	DQ3	20	DQ12	69	NC	70	DQS3	119	NC/ODT1	120	NC	169	DQS6	170	DM6
21	V <sub>SS</sub>	22	DQ13	71	V <sub>SS</sub>	72	V <sub>SS</sub>	121	V <sub>SS</sub>	122	V <sub>SS</sub>	171	V <sub>SS</sub>	172	V <sub>SS</sub>
23	DQ8	24	V <sub>SS</sub>	73	DQ26	74	DQ30	123	DQ32	124	DQ36	173	DQ50	174	DQ54
25	DQ9	26	DM1	75	DQ27	76	DQ31	125	DQ33	126	DQ37	175	DQ51	176	DQ55
27	V <sub>SS</sub>	28	V <sub>SS</sub>	77	V <sub>SS</sub>	78	V <sub>SS</sub>	127	V <sub>SS</sub>	128	V <sub>SS</sub>	177	V <sub>SS</sub>	178	V <sub>SS</sub>
29	DQS1	30	CK0	79	CKE0	80	NC/CKE1	129	DQS4	130	DM4	179	DQ56	180	DQ60
31	DQS1	32	CK0	81	V <sub>DD</sub>	82	V <sub>DD</sub>	131	DQS4	132	V <sub>SS</sub>	181	DQ57	182	DQ61
33	V <sub>SS</sub>	34	V <sub>SS</sub>	83	NC	84	NC	133	V <sub>SS</sub>	134	DQ38	183	V <sub>SS</sub>	184	V <sub>SS</sub>
35	DQ10	36	DQ14	85	BA2	86	NC	135	DQ34	136	DQ39	185	DM7	186	DQS7
37	DQ11	38	DQ15	87	V <sub>DD</sub>	88	V <sub>DD</sub>	137	DQ35	138	V <sub>SS</sub>	187	V <sub>SS</sub>	188	DQS7
39	V <sub>SS</sub>	40	V <sub>SS</sub>	89	A12	90	A11	139	V <sub>SS</sub>	140	DQ44	189	DQ58	190	V <sub>SS</sub>
41	V <sub>SS</sub>	42	V <sub>SS</sub>	91	A9	92	A7	141	DQ40	142	DQ45	191	DQ59	192	DQ62
43	DQ16	44	DQ20	93	A8	94	A6	143	DQ41	144	V <sub>SS</sub>	193	V <sub>SS</sub>	194	DQ63
45	DQ17	46	DQ21	95	V <sub>DD</sub>	96	V <sub>DD</sub>	145	V <sub>SS</sub>	146	DQS5	195	SDA	196	V <sub>SS</sub>
47	V <sub>SS</sub>	48	V <sub>SS</sub>	97	A5	98	A4	147	DM5	148	DQS5	197	SCL	198	SA0
49	DQS2	50	NC	99	A3	100	A2	149	V <sub>SS</sub>	150	V <sub>SS</sub>	199	V <sub>DDSPD</sub>	200	SA1

Note : NC = No Connect; NC, TEST(pin 163)is for bus analysis tool and is not connected on normal memory modules.

5.0 Pin Description

Pin Name	Description	Pin Name	Description
CK0,CK1	Clock Inputs, positive line	SDA	SPD Data Input/Output
CK0,CK1	Clock Inputs, negative line	SA1,SA0	SPD address
CKE0,CKE1	Clock Enables	DQ0~DQ63	Data Input/Output
RAS	Row Address Strobe	DM0~DM7	Data Masks
CAS	Column Address Strobe	DQS0~DQS7	Data strobes
WE	Write Enable	DQS0~DQS7	Data strobes complement
S0,S1	Chip Selects	TEST	Logic Analyzer specific test pin (No connect on So-DIMM)
A0~A9, A11~A13	Address Inputs	V <sub>DD</sub>	Core and I/O Power
A10/AP	Address Input/Autoprecharge	V <sub>SS</sub>	Ground
BA0~BA2	SDRAM Bank Address	V <sub>REF</sub>	Input/Output Reference
ODT0,ODT1	On-die termination control	V <sub>DDSPD</sub>	SPD Power
SCL	Serial Presence Detect (SPD) Clock Input	NC	Spare pins, No connect
CK0,CK1	Clock Inputs, positive line	SDA	SPD Data Input/Output

\*The V<sub>DD</sub> and V<sub>DDQ</sub> pins are tied to the single power-plane on PCB.

**6.0 Input/Output Function Description**

Symbol	Type	Description
$\overline{CK0-CK1}$ $\overline{CK0-CK1}$	Input	The system clock inputs. All address and command lines are sampled on the cross point of the rising edge of CK and falling edge of CK. A Delay Locked Loop (DLL) circuit is driven from the clock input and output timing for read operations is synchronized to the input clock.
CKE0-CKE1	Input	Activates the DDR2 SDRAM CK signal when high and deactivates the CK signal when low. By deactivating the clocks, CKE low initiates the Power Down mode or the Self Refresh mode.
$\overline{S0-S1}$	Input	Enables the associated DDR2 SDRAM command decoder when low and disables the command decoder when high. When the command decoder is disabled, new commands are ignored but previous operations continue. Rank 0 is selected by $\overline{S0}$ , Rank 1 is selected by $\overline{S1}$ . Ranks are also called "Physical banks".
$\overline{RAS}$ , $\overline{CAS}$ , $\overline{WE}$	Input	When sampled at the cross point of the rising edge of CK and falling edge of CK, $\overline{CAS}$ , $\overline{RAS}$ , and $\overline{WE}$ define the operation to be executed by the SDRAM.
BA0~BA2	Input	Selects which DDR2 SDRAM internal bank is activated.
ODT0~ODT1	Input	Asserts on-die termination for DQ, DM, DQS, and $\overline{DQS}$ signals if enabled via the DDR2 SDRAM Extended Mode Register Set (EMRS).
A0~A9, A10/AP, A11~A13	Input	During a Bank Activate command cycle, defines the row address when sampled at the cross point of the rising edge of CK and falling edge of CK. During a Read or Write command cycle, defines the column address when sampled at the cross point of the rising edge of CK and falling edge of CK. In addition to the column address, AP is used to invoke autoprecharge operation at the end of the burst read or write cycle. If AP is high, autoprecharge is selected and BA0-BAn defines the bank to be precharged. If AP is low, autoprecharge is disabled. During a Precharge command cycle, AP is used in conjunction with BA0-BAn to control which bank(s) to precharge. If AP is high, all banks will be precharged regardless of the state of BA0-BAn inputs. If AP is low, then BA0-BAn are used to define which bank to precharge.
DQ0~DQ63	In/Out	Data Input/Output pins.
DM0~DM7	Input	The data write masks, associated with one data byte. In Write mode, DM operates as a byte mask by allowing input data to be written if it is low but blocks the write operation if it is high. In Read mode, DM lines have no effect.
$\overline{DQS0-DQS7}$ $\overline{DQS0-DQS7}$	In/Out	The data strobes, associated with one data byte, sourced with data transfers. In Write mode, the data strobe is sourced by the controller and is centered in the data window. In Read mode, the data strobe is sourced by the DDR2 SDRAMs and is sent at the leading edge of the data window. $\overline{DQS}$ signals are complements, and timing is relative to the crosspoint of respective DQS and $\overline{DQS}$ . If the module is to be operated in single ended strobe mode, all $\overline{DQS}$ signals must be tied on the system board to $V_{SS}$ and DDR2 SDRAM mode registers programmed appropriately.
$V_{DD}$ , $V_{DDSPD}$ , $V_{SS}$	Supply	Power supplies for core, I/O, Serial Presence Detect, and ground for the module.
SDA	In/Out	This is a bidirectional pin used to transfer data into or out of the SPD EEPROM. A resistor must be connected to $V_{DD}$ to act as a pull up.
SCL	Input	This signal is used to clock data into and out of the SPD EEPROM. A resistor may be connected from SCL to $V_{DD}$ to act as a pull up.
SA0~SA1	Input	Address pins used to select the Serial Presence Detect base address.
TEST	In/Out	The TEST pin is reserved for bus analysis tools and is not connected on normal memory modules (SODIMMs).

7.0 Functional Block Diagram :

7.1 2GB, 256Mx64 Module - M470T5663EH3

(Populated as 2 ranks of x8 DDR2 SDRAMs)

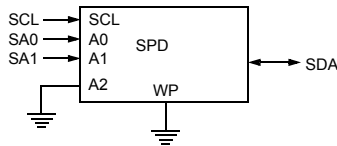
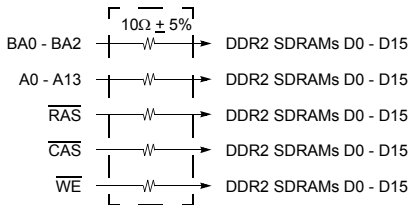
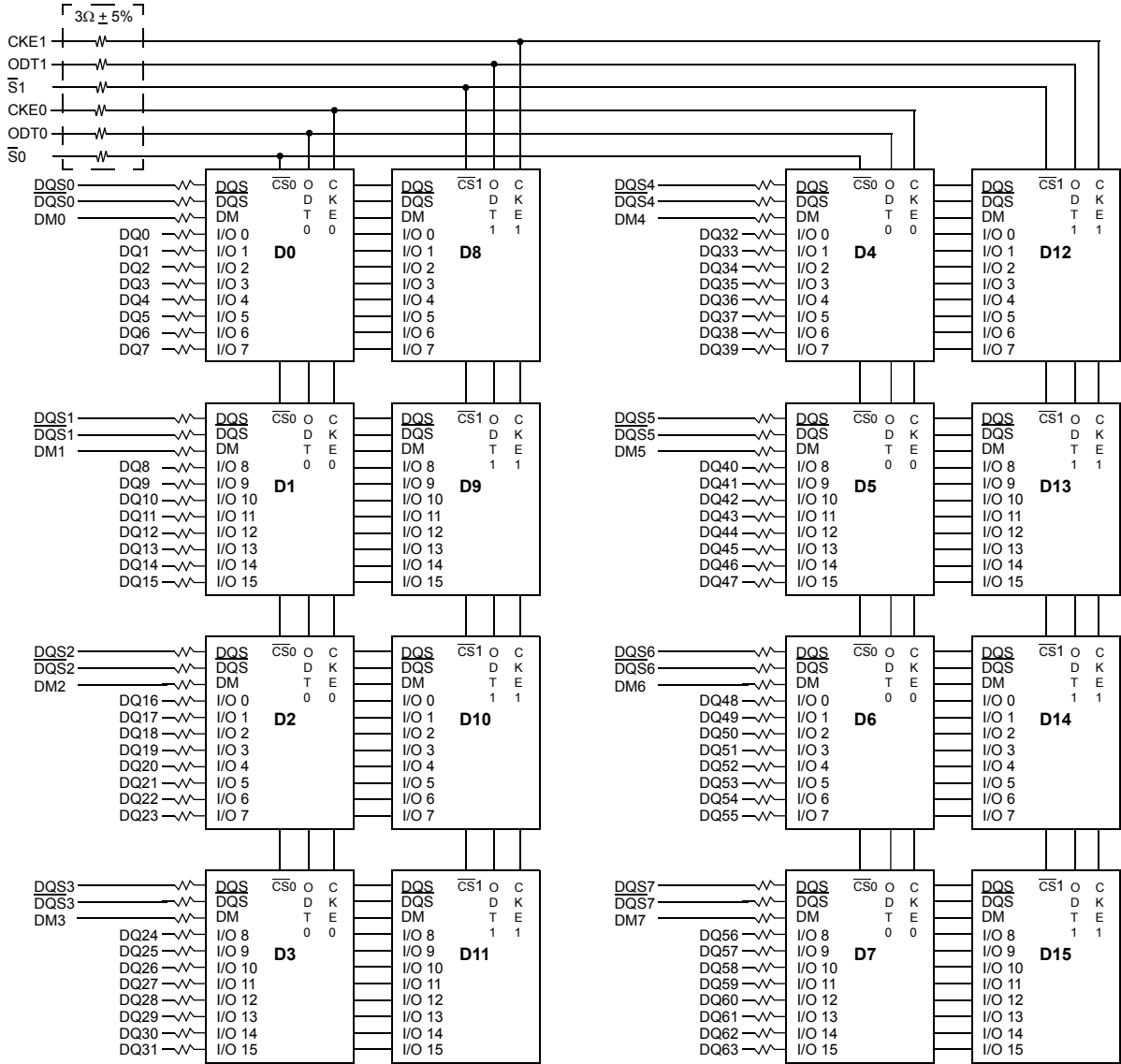

* Clock Wiring	
Clock Input	DDR2 SDRAMs
*CK0/CK0	8 DDR2 SDRAMs
*CK1/CK1	8 DDR2 SDRAMs

\* Wire per Clock Loading Table/Wiring Diagrams

Note :

1. DQ,DM, DQS/DQS resistors : 22 Ohms ± 5%.
2. BAx, Ax, RAS, CAS, WE resistors : 10.0 Ohms ± 5%.

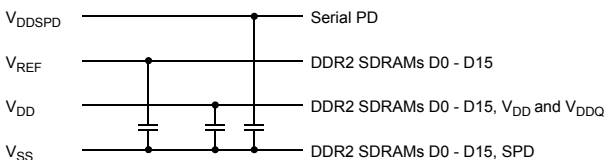

7.2 1GB, 128Mx64 Module - M470T2864EH3

(Populated as 2 rank of x16 DDR2 SDRAMs)

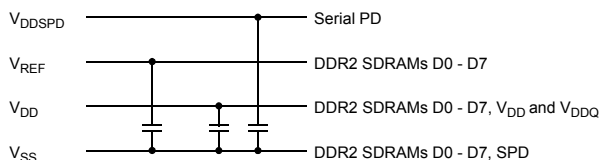
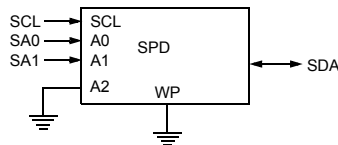
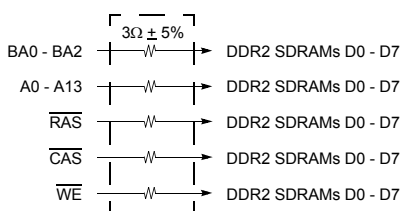
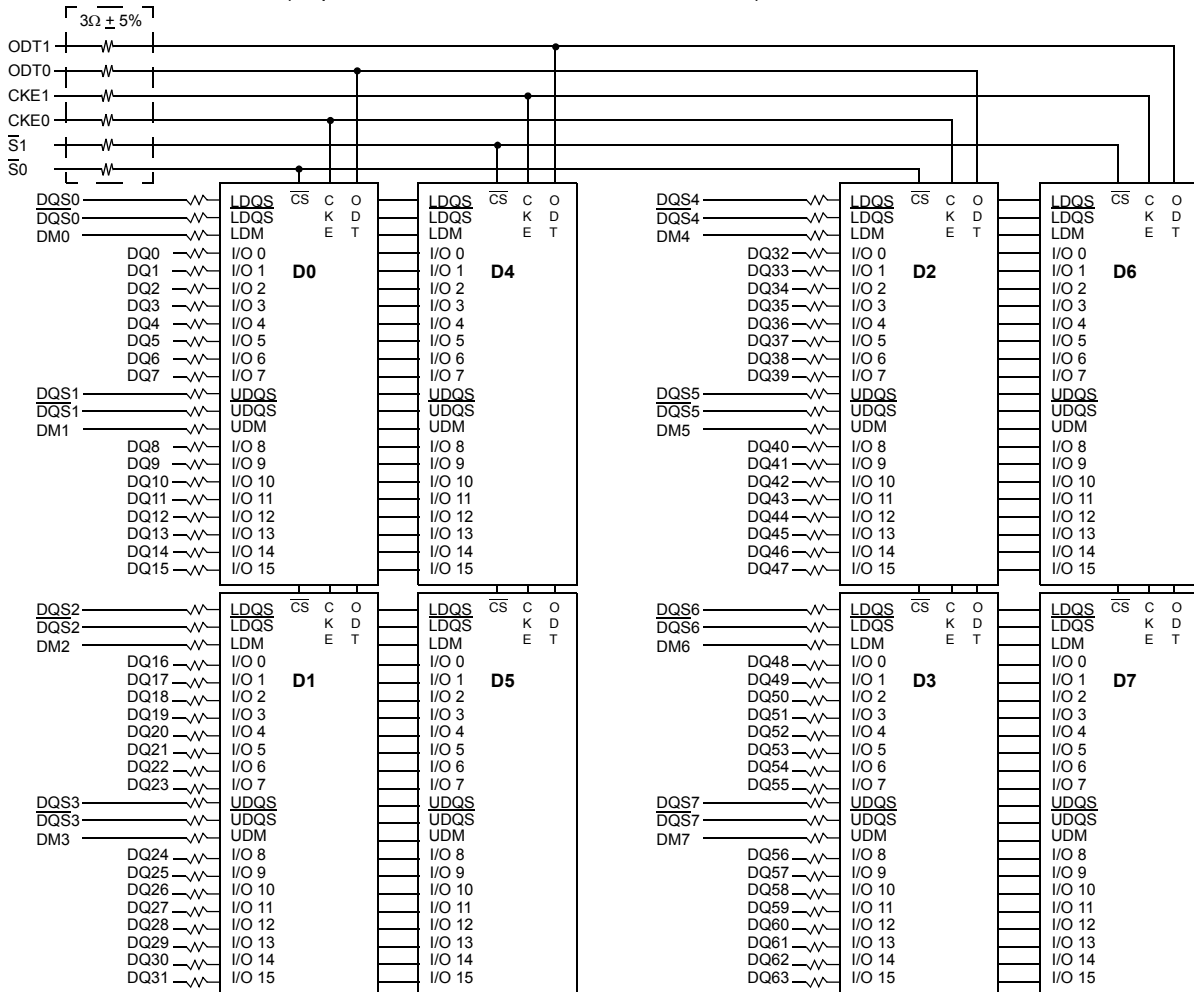

* Clock Wiring	
Clock Input	DDR2 SDRAMs
*CK0/CK0	4 DDR2 SDRAMs
*CK1/CK1	4 DDR2 SDRAMs

\* Wire per Clock Loading Table/Wiring Diagrams

Note :

1. DQ,DM, DQS/DQS resistors : 22 Ohms ± 5%.
2. BAx, Ax, RAS, CAS, WE resistors : 3.0 Ohms ± 5%.



7.3 1GB, 128Mx64 Module - M470T2863EH3

(Populated as 1 rank of x8 DDR2 SDRAMs)

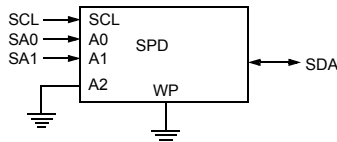
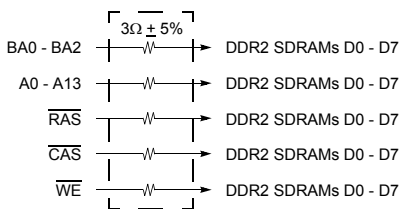
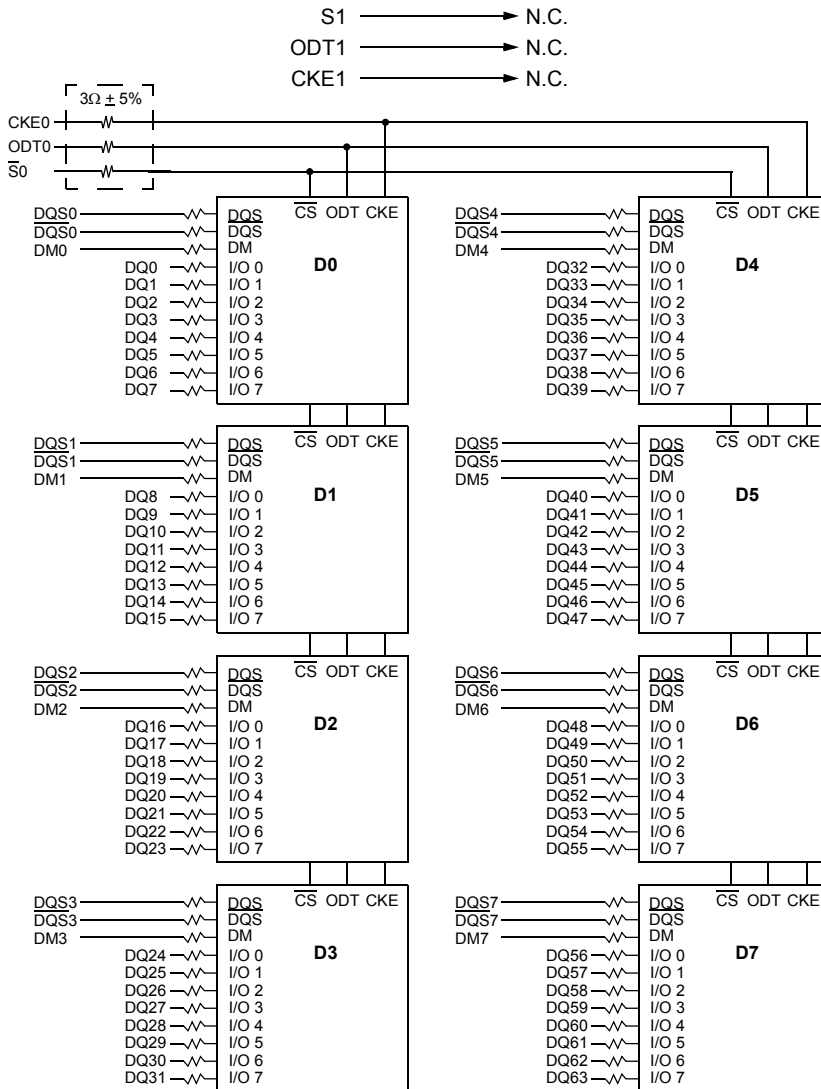

* Clock Wiring	
Clock Input	DDR2 SDRAMs
*CK0/CK0	4 DDR2 SDRAMs
*CK1/CK1	4 DDR2 SDRAMs

\* Wire per Clock Loading Table/Wiring Diagrams

Note :

1. DQ,DM, DQS/DQS resistors : 22 Ohms ± 5%.
2. BAx, Ax, RAS, CAS, WE resistors : 3.0 Ohms ± 5%.

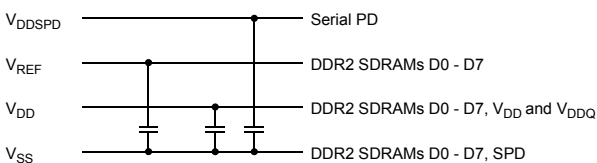

7.4 512MB, 64Mx64 Module - M470T6464EHS

(Populated as 1 rank of x16 DDR2 SDRAMs)

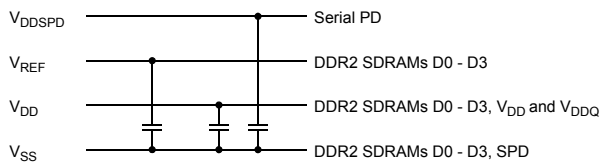
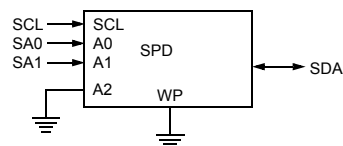
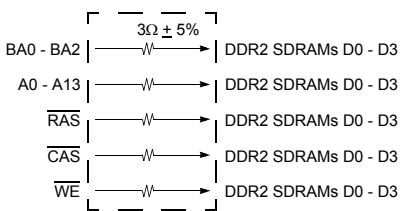
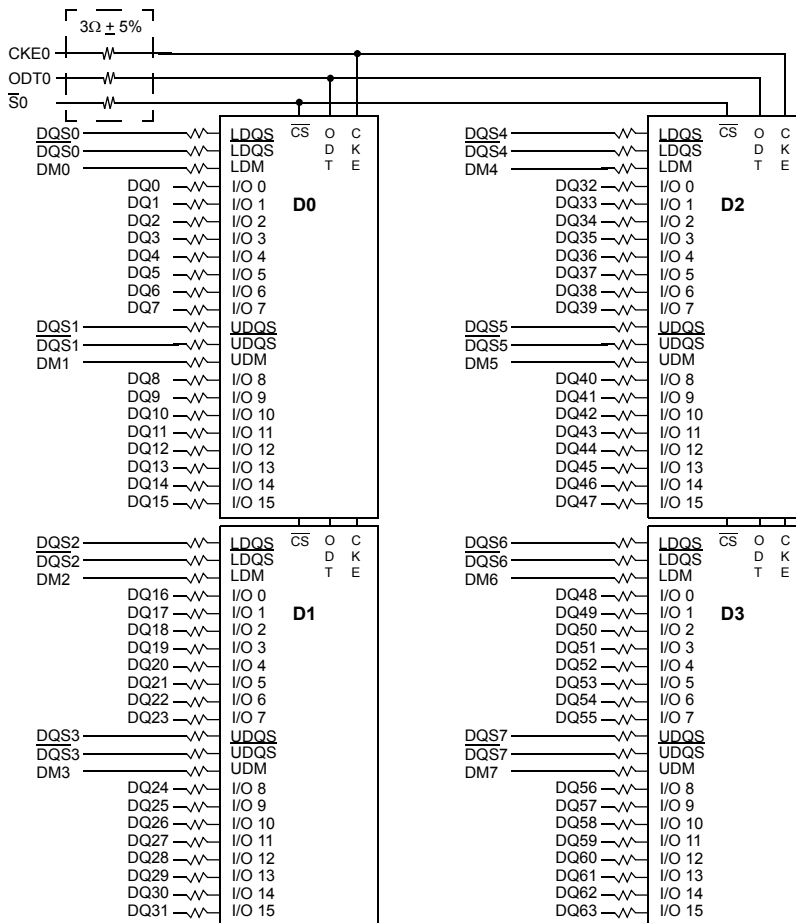

* Clock Wiring	
Clock Input	DDR2 SDRAMs
*CK0/CK0	2 DDR2 SDRAMs
*CK1/CK1	2 DDR2 SDRAMs

\* Wire per Clock Loading Table/Wiring Diagrams

Note :

1. DQ, DM, DQS/DQS resistors : 22 Ohms ± 5%.
2. BAx, Ax, RAS, CAS, WE resistors : 3.0 Ohms ± 5%.

## 8.0 Absolute Maximum DC Ratings

Symbol	Parameter	Rating	Units	Notes
V <sub>DD</sub>	Voltage on V <sub>DD</sub> pin relative to V <sub>SS</sub>	- 1.0 V ~ 2.3 V	V	1
V <sub>DDQ</sub>	Voltage on V <sub>DDQ</sub> pin relative to V <sub>SS</sub>	- 0.5 V ~ 2.3 V	V	1
V <sub>DDL</sub>	Voltage on V <sub>DDL</sub> pin relative to V <sub>SS</sub>	- 0.5 V ~ 2.3 V	V	1
V <sub>IN</sub> , V <sub>OUT</sub>	Voltage on any pin relative to V <sub>SS</sub>	- 0.5 V ~ 2.3 V	V	1
T <sub>STG</sub>	Storage Temperature	-55 to +100	°C	1, 2

Note :

- Stresses greater than those listed under "Absolute Maximum Ratings" may cause permanent damage to the device. This is a stress rating only and functional operation of the device at these or any other conditions above those indicated in the operational sections of this specification is not implied. Exposure to absolute maximum rating conditions for extended periods may affect reliability.
- Storage Temperature is the case surface temperature on the center/top side of the DRAM. For the measurement conditions, please refer to JESD51-2 standard.

## 9.0 AC & DC Operating Conditions

### 9.1 Recommended DC Operating Conditions (SSTL - 1.8)

Symbol	Parameter	Rating			Units	Notes
		Min.	Typ.	Max.		
V <sub>DD</sub>	Supply Voltage	1.7	1.8	1.9	V	
V <sub>DDL</sub>	Supply Voltage for DLL	1.7	1.8	1.9	V	4
V <sub>DDQ</sub>	Supply Voltage for Output	1.7	1.8	1.9	V	4
V <sub>REF</sub>	Input Reference Voltage	0.49*V <sub>DDQ</sub>	0.50*V <sub>DDQ</sub>	0.51*V <sub>DDQ</sub>	mV	1,2
V <sub>TT</sub>	Termination Voltage	V <sub>REF</sub> -0.04	V <sub>REF</sub>	V <sub>REF</sub> +0.04	V	3

Symbol	Parameter	Rating		Units	Notes
		Min.	Max.		
V <sub>DDSPD</sub>	Core Supply Voltage	1.7	3.6	V	5

Note : There is no specific device V<sub>DD</sub> supply voltage requirement for SSTL-1.8 compliance. However under all conditions V<sub>DDQ</sub> must be less than or equal to V<sub>DD</sub>.

- The value of V<sub>REF</sub> may be selected by the user to provide optimum noise margin in the system. Typically the value of V<sub>REF</sub> is expected to be about 0.5 x V<sub>DDQ</sub> of the transmitting device and V<sub>REF</sub> is expected to track variations in V<sub>DDQ</sub>.
- Peak to peak AC noise on V<sub>REF</sub> may not exceed +/-2% V<sub>REF</sub>(DC).
- V<sub>TT</sub> of transmitting device must track V<sub>REF</sub> of receiving device.
- AC parameters are measured with V<sub>DD</sub>, V<sub>DDQ</sub> and V<sub>DDL</sub> tied together.
- SODIMMs that include an optional temperature sensor may require a restricted V<sub>DDSPD</sub> operating voltage range for proper operation of the temperature sensor. Refer to the thermal sensor specification for details regarding the supported voltage range. All other functions of the SODIMM SPD are supported across the full V<sub>DDSPD</sub> range.

9.2 Operating Temperature Condition

Symbol	Parameter	Rating	Units	Notes
T <sub>OPER</sub>	Operating Temperature	0 to 95	°C	1, 2

Note :

1. Operating Temperature is the case surface temperature on the center/top side of the DRAM. For the measurement conditions, please refer to JESD51.2 standard.
2. At 85 - 95 °C operation temperature range, doubling refresh commands in frequency to a 32ms period ( tREFI=3.9 us ) is required, and to enter to self refresh mode at this temperature range, an EMRS command is required to change internal refresh rate.

9.3 Input DC Logic Level

Symbol	Parameter	Min.	Max.	Units	Notes
V <sub>IH</sub> (DC)	DC input logic high	V <sub>REF</sub> + 0.125	V <sub>DDQ</sub> + 0.3	V	
V <sub>IL</sub> (DC)	DC input logic low	- 0.3	V <sub>REF</sub> - 0.125	V	

9.4 Input AC Logic Level

Symbol	Parameter	DDR2-667, DDR2-800		Units
		Min.	Max.	
V <sub>IH</sub> (AC)	AC input logic high	V <sub>REF</sub> + 0.200		V
V <sub>IL</sub> (AC)	AC input logic low		V <sub>REF</sub> - 0.200	V

9.5 AC Input Test Conditions

Symbol	Condition	Value	Units	Notes
V <sub>REF</sub>	Input reference voltage	0.5 * V <sub>DDQ</sub>	V	1
V <sub>SWING</sub> (MAX)	Input signal maximum peak to peak swing	1.0	V	1
SLEW	Input signal minimum slew rate	1.0	V/ns	2, 3

Note:

1. Input waveform timing is referenced to the input signal crossing through the V<sub>IH/IL</sub>(AC) level applied to the device under test.
2. The input signal minimum slew rate is to be maintained over the range from V<sub>REF</sub> to V<sub>IH</sub>(AC) min for rising edges and the range from V<sub>REF</sub> to V<sub>IL</sub>(AC) max for falling edges as shown in the below figure.
3. AC timings are referenced with input waveforms switching from V<sub>IL</sub>(AC) to V<sub>IH</sub>(AC) on the positive transitions and V<sub>IH</sub>(AC) to V<sub>IL</sub>(AC) on the negative transitions.

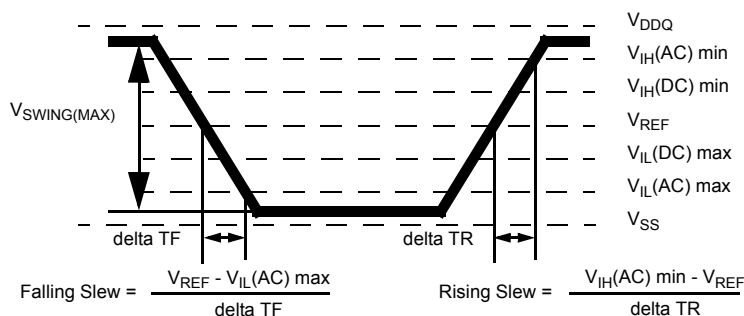

< AC Input Test Signal Waveform >

### 10.0 IDD Specification Parameters Definition

(IDD values are for full operating range of Voltage and Temperature)

Symbol	Proposed Conditions	Units	Note
IDD0	<b>Operating one bank active-precharge current;</b> tCK = tCK(IDD), tRC = tRC(IDD), tRAS = tRASmin(IDD); CKE is HIGH, $\overline{CS}$ is HIGH between valid commands; Address bus inputs are SWITCHING; Data bus inputs are SWITCHING	mA	
IDD1	<b>Operating one bank active-read-precharge current;</b> IOUT = 0mA; BL = 4, CL = CL(IDD), AL = 0; tCK = tCK(IDD), tRC = tRC(IDD), tRAS = tRASmin(IDD), tRCD = tRCD(IDD); CKE is HIGH, $\overline{CS}$ is HIGH between valid commands; Address bus inputs are SWITCHING; Data pattern is same as IDD4W	mA	
IDD2P	<b>Precharge power-down current;</b> All banks idle; tCK = tCK(IDD); CKE is LOW; Other control and address bus inputs are STABLE; Data bus inputs are FLOATING	mA	
IDD2Q	<b>Precharge quiet standby current;</b> All banks idle; tCK = tCK(IDD); CKE is HIGH, $\overline{CS}$ is HIGH; Other control and address bus inputs are STABLE; Data bus inputs are FLOATING	mA	
IDD2N	<b>Precharge standby current;</b> All banks idle; tCK = tCK(IDD); CKE is HIGH, $\overline{CS}$ is HIGH; Other control and address bus inputs are SWITCHING; Data bus inputs are SWITCHING	mA	
IDD3P	<b>Active power-down current;</b> All banks open; tCK = tCK(IDD); CKE is LOW; Other control and address bus inputs are STABLE; Data bus inputs are FLOATING	Fast PDN Exit MRS(12) = 0	mA
		Slow PDN Exit MRS(12) = 1	mA
IDD3N	<b>Active standby current;</b> All banks open; tCK = tCK(IDD), tRAS = tRASmax(IDD), tRP = tRP(IDD); CKE is HIGH, $\overline{CS}$ is HIGH between valid commands; Other control and address bus inputs are SWITCHING; Data bus inputs are SWITCHING	mA	
IDD4W	<b>Operating burst write current;</b> All banks open, Continuous burst writes; BL = 4, CL = CL(IDD), AL = 0; tCK = tCK(IDD), tRAS = tRASmax(IDD), tRP = tRP(IDD); CKE is HIGH, $\overline{CS}$ is HIGH between valid commands; Address bus inputs are SWITCHING; Data bus inputs are SWITCHING	mA	
IDD4R	<b>Operating burst read current;</b> All banks open, Continuous burst reads, IOUT = 0mA; BL = 4, CL = CL(IDD), AL = 0; tCK = tCK(IDD), tRAS = tRASmax(IDD), tRP = tRP(IDD); CKE is HIGH, $\overline{CS}$ is HIGH between valid commands; Address bus inputs are SWITCHING; Data pattern is same as IDD4W	mA	
IDD5B	<b>Burst auto refresh current;</b> tCK = tCK(IDD); Refresh command at every tRFC(IDD) interval; CKE is HIGH, $\overline{CS}$ is HIGH between valid commands; Other control and address bus inputs are SWITCHING; Data bus inputs are SWITCHING	mA	
IDD6	<b>Self refresh current;</b> CK and $\overline{CK}$ at 0V; CKE ≤ 0.2V; Other control and address bus inputs are FLOATING; Data bus inputs are FLOATING	Normal	mA
		Low Power	mA
IDD7	<b>Operating bank interleave read current;</b> All bank interleaving reads, IOUT = 0mA; BL = 4, CL = CL(IDD), AL = tRCD(IDD)-1*tCK(IDD); tCK = tCK(IDD), tRC = tRC(IDD), tRRD = tRRD(IDD), tFAW = tFAW(IDD), tRCD = 1*tCK(IDD); CKE is HIGH, $\overline{CS}$ is HIGH between valid commands; Address bus inputs are STABLE during DESELECTs; Data pattern is same as IDD4R; Refer to the following page for detailed timing conditions	mA	

**11.0 Operating Current Table :**

**11.1 M470T5663EH3 : 256Mx64 2GB Module**

(TA=0°C, V<sub>DD</sub>= 1.9V)

Symbol	800@CL=5		800@CL=6		667@CL=5		Units	Notes
	CE7	LE7	CF7	LF7	CE6	LE6		
IDD0	776		776		720		mA	
IDD1	856		856		800		mA	
IDD2P	160	80	160	80	160	80	mA	
IDD2Q	400		400		400		mA	
IDD2N	512		512		480		mA	
IDD3P-F	448		448		432		mA	
IDD3P-S	240		240		240		mA	
IDD3N	576		576		536		mA	
IDD4W	1,016		1,016		960		mA	
IDD4R	1,256		1,256		1,160		mA	
IDD5	1,072		1,072		1,120		mA	
IDD6	160	80	160	80	160	128	mA	
IDD7	1,856		1,856		1,720		mA	

\* Module IDD was calculated on the basis of component IDD and can be differently measured according to DQ loading cap.

**11.2 M470T2864EH3 : 128Mx64 1GB Module**

(TA=0°C, V<sub>DD</sub>= 1.9V)

Symbol	800@CL=5		800@CL=6		667@CL=5		Units	Notes
	CE7	LE7	CF7	LF7	CE6	LE6		
IDD0	320		320		308		mA	
IDD1	344		344		328		mA	
IDD2P	80	40	80	40	80	40	mA	
IDD2Q	184		184		184		mA	
IDD2N	224		224		216		mA	
IDD3P-F	208		208		200		mA	
IDD3P-S	120		120		120		mA	
IDD3N	260		260		248		mA	
IDD4W	400		400		368		mA	
IDD4R	472		472		428		mA	
IDD5	592		592		568		mA	
IDD6	80	40	80	40	80	40	mA	
IDD7	792		792		728		mA	

\* Module IDD was calculated on the basis of component IDD and can be differently measured according to DQ loading cap.

**11.3 M470T2863EH3: 128Mx64 1GB Module**

(TA=0°C, V<sub>DD</sub>= 1.9V)

Symbol	800@CL=5		800@CL=6		667@CL=5		Units	Notes
	CE7	LE7	CF7	LF7	CE6	LE6		
IDD0	520		520		480		mA	
IDD1	600		600		560		mA	
IDD2P	80	40	80	40	80	40	mA	
IDD2Q	200		200		200		mA	
IDD2N	256		256		240		mA	
IDD3P-F	224		224		216		mA	
IDD3P-S	120		120		120		mA	
IDD3N	320		320		296		mA	
IDD4W	760		760		720		mA	
IDD4R	1,000		1,000		920		mA	
IDD5	816		816		880		mA	
IDD6	80	40	80	40	80	64	mA	
IDD7	1,600		1,600		1,480		mA	

\* Module IDD was calculated on the basis of component IDD and can be differently measured according to DQ loading cap.

**11.4 M470T6464EHS: 64Mx64 512MB Module**

(TA=0°C, V<sub>DD</sub>= 1.9V)

Symbol	800@CL=5		800@CL=6		667@CL=5		Units	Notes
	CE7	LE7	CF7	LF7	CE6	LE6		
IDD0	208		208		200		mA	
IDD1	232		232		220		mA	
IDD2P	40	20	40	20	40	20	mA	
IDD2Q	92		92		92		mA	
IDD2N	112		112		108		mA	
IDD3P-F	104		104		100		mA	
IDD3P-S	60		60		60		mA	
IDD3N	148		148		140		mA	
IDD4W	288		288		260		mA	
IDD4R	360		360		320		mA	
IDD5	480		480		460		mA	
IDD6	40	20	40	20	40	20	mA	
IDD7	680		680		620		mA	

\* Module IDD was calculated on the basis of component IDD and can be differently measured according to DQ loading cap.

12.0 Input/Output Capacitance

(V<sub>DD</sub>=1.8V, V<sub>DDQ</sub>=1.8V, TA=25°C)

Parameter	Symbol	Min	Max	Min	Max	Units
Non-ECC		M470T5663EH3		M470T2864EH3		
Input capacitance, CK and $\overline{CK}$	CCK	-	48	-	32	pF
Input capacitance, CKE, $\overline{CS}$ , Addr, $\overline{RAS}$ , $\overline{CAS}$ , $\overline{WE}$	CI	-	42	-	34	
Input/output capacitance, DQ, DM, DQS, $\overline{DQS}$	CIO	-	9	-	9	
Non-ECC	Symbol	M470T2863EH3		M470T6464EHS		Units
Input capacitance, CK and $\overline{CK}$	CCK	-	32	-	24	pF
Input capacitance, CKE, $\overline{CS}$ , Addr, $\overline{RAS}$ , $\overline{CAS}$ , $\overline{WE}$	CI	-	42	-	34	
Input/output capacitance, DQ, DM, DQS, $\overline{DQS}$	CIO	-	5.5	-	5.5	

\* DM is internally loaded to match DQ and DQS identically.

13.0 Electrical Characteristics & AC Timing for DDR2-800/667

(0 °C ≤ T<sub>OPER</sub> ≤ 95 °C; V<sub>DDQ</sub> = 1.8V ± 0.1V; V<sub>DD</sub> = 1.8V ± 0.1V)

13.1 Refresh Parameters by Device Density

Parameter	Symbol	256Mb	512Mb	1Gb	2Gb	4Gb	Units	
Refresh to active/Refresh command time	tRFC	75	105	127.5	195	327.5	ns	
Average periodic refresh interval	tREFI	0 °C ≤ T <sub>CASE</sub> ≤ 85 °C	7.8	7.8	7.8	7.8	7.8	μs
		85 °C < T <sub>CASE</sub> ≤ 95 °C	3.9	3.9	3.9	3.9	3.9	μs

13.2 Speed Bins and CL, tRCD, tRP, tRC and tRAS for Corresponding Bin

Speed	DDR2-800(E7)		DDR2-800(F7)		DDR2-667(E6)		Units
Bin(CL - tRCD - tRP)	5 - 5 - 5		6 - 6 - 6		5 - 5 - 5		
Parameter	min	max	min	max	min	max	
tCK, CL=3	5	8	-	-	5	8	ns
tCK, CL=4	3.75	8	3.75	8	3.75	8	ns
tCK, CL=5	2.5	8	3	8	3	8	ns
tCK, CL=6	-	-	2.5	8	-	-	ns
tRCD	12.5	-	15	-	15	-	ns
tRP	12.5	-	15	-	15	-	ns
tRC	57.5	-	60	-	60	-	ns
tRAS	45	70000	45	70000	45	70000	ns



**13.3 Timing Parameters by Speed Grade**

(Refer to notes for informations related to this table at the component datasheet)

Parameter	Symbol	DDR2-800		DDR2-667		Units	Notes
		min	max	min	max		
DQ output access time from CK/ $\overline{\text{CK}}$	tAC	-400	400	-450	450	ps	40
DQS output access time from CK/ $\overline{\text{CK}}$	tDQSCK	-350	350	-400	400	ps	40
Average clock HIGH pulse width	tCH(avg)	0.48	0.52	0.48	0.52	tCK(avg)	35,36
Average clock LOW pulse width	tCL(avg)	0.48	0.52	0.48	0.52	tCK(avg)	35,36
CK half pulse period	tHP	Min(tCL(abs), tCH(abs))	x	Min(tCL(abs), tCH(abs))	x	ps	37
Average clock period	tCK(avg)	2500	8000	3000	8000	ps	35,36
DQ and DM input hold time	tDH(base)	125	x	175	x	ps	6,7,8,21,28,31
DQ and DM input setup time	tDS(base)	50	x	100	x	ps	6,7,8,20,28,31
Control & Address input pulse width for each input	tIPW	0.6	x	0.6	x	tCK(avg)	
DQ and DM input pulse width for each input	tDIPW	0.35	x	0.35	x	tCK(avg)	
Data-out high-impedance time from CK/ $\overline{\text{CK}}$	tHZ	x	tAC(max)	x	tAC(max)	ps	18,40
DQS/ $\overline{\text{DQS}}$ low-impedance time from CK/ $\overline{\text{CK}}$	tLZ(DQS)	tAC(min)	tAC(max)	tAC(min)	tAC(max)	ps	18,40
DQ low-impedance time from CK/ $\overline{\text{CK}}$	tLZ(DQ)	2* tAC(min)	tAC(max)	2* tAC(min)	tAC(max)	ps	18,40
DQS-DQ skew for DQS and associated DQ signals	tDQSQ	x	200	x	240	ps	13
DQ hold skew factor	tQHS	x	300	x	340	ps	38
DQ/DQS output hold time from DQS	tQH	tHP - tQHS	x	tHP - tQHS	x	ps	39
DQS latching rising transitions to associated clock edges	tDQSS	- 0.25	0.25	-0.25	0.25	tCK(avg)	30
DQS input HIGH pulse width	tDQSH	0.35	x	0.35	x	tCK(avg)	
DQS input LOW pulse width	tDQSL	0.35	x	0.35	x	tCK(avg)	
DQS falling edge to CK setup time	tDSS	0.2	x	0.2	x	tCK(avg)	30
DQS falling edge hold time from CK	tDSH	0.2	x	0.2	x	tCK(avg)	30
Mode register set command cycle time	tMRD	2	x	2	x	nCK	
MRS command to ODT update delay	tMOD	0	12	0	12	ns	32
Write postamble	tWPST	0.4	0.6	0.4	0.6	tCK(avg)	10
Write preamble	tWPRE	0.35	x	0.35	x	tCK(avg)	
Address and control input hold time	tIH(base)	250	x	275	x	ps	5,7,9,23,29
Address and control input setup time	tIS(base)	175	x	200	x	ps	5,7,9,22,29
Read preamble	tRPRE	0.9	1.1	0.9	1.1	tCK(avg)	19,41
Read postamble	tRPST	0.4	0.6	0.4	0.6	tCK(avg)	19,42
Activate to activate command period for 1KB page size products	tRRD	7.5	x	7.5	x	ns	4,32
Activate to activate command period for 2KB page size products	tRRD	10	x	10	x	ns	4,32

Parameter	Symbol	DDR2-800		DDR2-667		Units	Notes
		min	max	min	max		
Four Activate Window for 1KB page size products	tFAW	35	x	37.5	x	ns	32
Four Activate Window for 2KB page size products	tFAW	45	x	50	x	ns	32
$\overline{\text{CAS}}$ to $\overline{\text{CAS}}$ command delay	tCCD	2	x	2	x	nCK	
Write recovery time	tWR	15	x	15	x	ns	32
Auto precharge write recovery + precharge time	tDAL	WR + tnRP	x	WR + tnRP	x	nCK	33
Internal write to read command delay	tWTR	7.5	x	7.5	x	ns	24,32
Internal read to precharge command delay	tRTP	7.5	x	7.5	x	ns	3,32
Exit self refresh to a non-read command	tXSNR	tRFC + 10	x	tRFC + 10	x	ns	32
Exit self refresh to a read command	tXSRD	200	x	200	x	nCK	
Exit precharge power down to any command	tXP	2	x	2	x	nCK	
Exit active power down to read command	tXARD	2	x	2	x	nCK	1
Exit active power down to read command (slow exit, lower power)	tXARDS	8 - AL	x	7 - AL	x	nCK	1,2
CKE minimum pulse width (HIGH and LOW pulse width)	tCKE	3	x	3	x	nCK	27
ODT turn-on delay	tAOND	2	2	2	2	nCK	16
ODT turn-on	tAON	tAC(min)	tAC(max)+0.7	tAC(min)	tAC(max)+0.7	ns	6,16,40
ODT turn-on (Power-Down mode)	tAONPD	tAC(min)+2	2*tCK(avg)+tAC(max)+1	tAC(min)+2	2*tCK(avg)+tAC(max)+1	ns	
ODT turn-off delay	tAOFD	2.5	2.5	2.5	2.5	nCK	17,45
ODT turn-off	tAOF	tAC(min)	tAC(max)+0.6	tAC(min)	tAC(max)+0.6	ns	17,43,45
ODT turn-off (Power-Down mode)	tAOFPD	tAC(min)+2	2.5*tCK(avg)+tAC(max)+1	tAC(min)+2	2.5*tCK(avg)+tAC(max)+1	ns	
ODT to power down entry latency	tANPD	3	x	3	x	nCK	
ODT power down exit latency	tAXPD	8	x	8	x	nCK	
OCD drive mode output delay	tOIT	0	12	0	12	ns	32
Minimum time clocks remains ON after CKE asynchronously drops LOW	tDelay	tIS+tCK(avg)+tIH	x	tIS+tCK(avg)+tIH	x	ns	15

**14.0 Physical Dimensions :**

**14.1 128Mbx8 based 256Mx64 Module (2 Rank)  
- M470T5663EH3**

Units : Millimeters

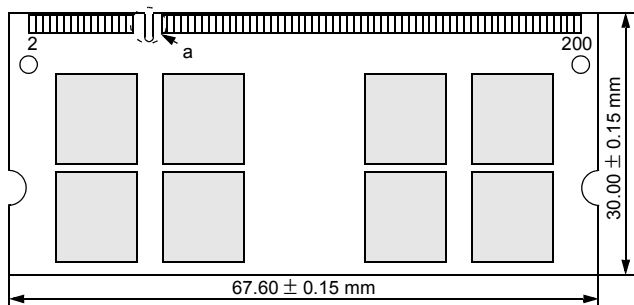
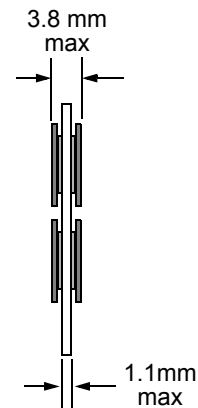
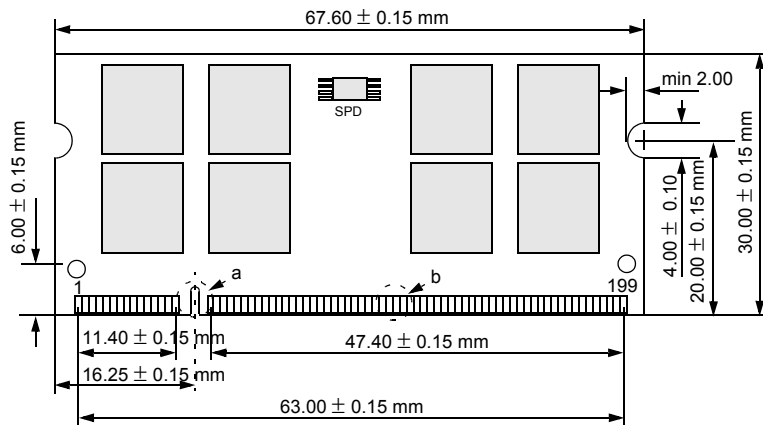

**DETAIL a**

**DETAIL b**

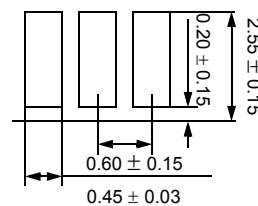
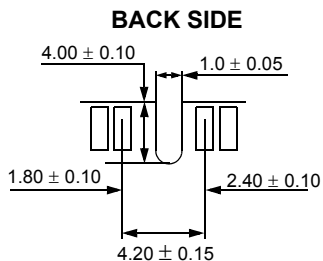
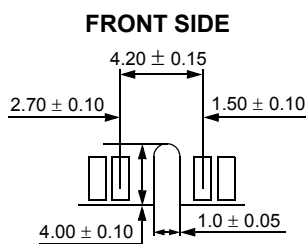

The used device is 128M x8 DDR2 SDRAM, FBGA.  
DDR2 SDRAM Part NO : K4T1G084QE

**14.2 64Mbx16 based 128Mx64 Module (2 Rank)  
- M470T2864EH3**

Units : Millimeters

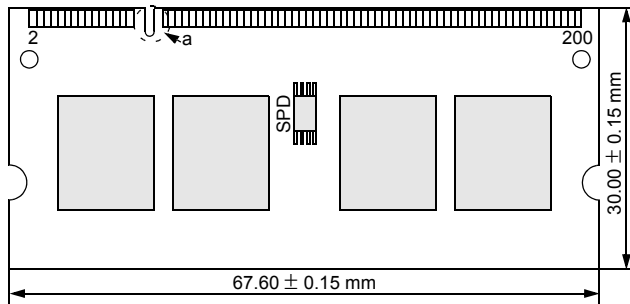
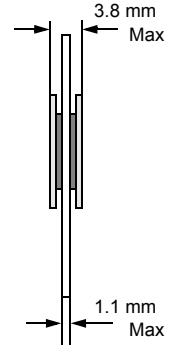
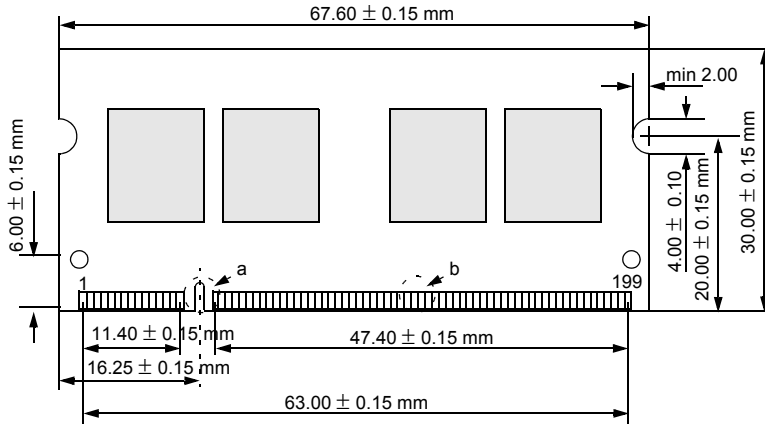

**DETAIL a**

**DETAIL b**

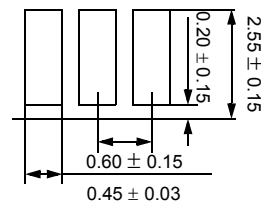
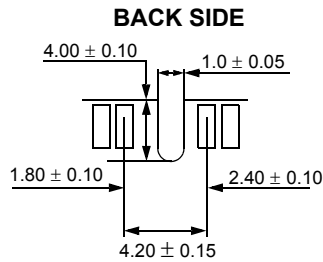
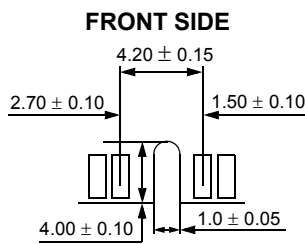

The used device is 64M x16 DDR2 SDRAM, FBGA.  
DDR2 SDRAM Part NO : K4T1G164QE

14.3 128Mbx8 based 128Mx64 Module (1 Rank)

Units : Millimeters

- M470T2863EH3

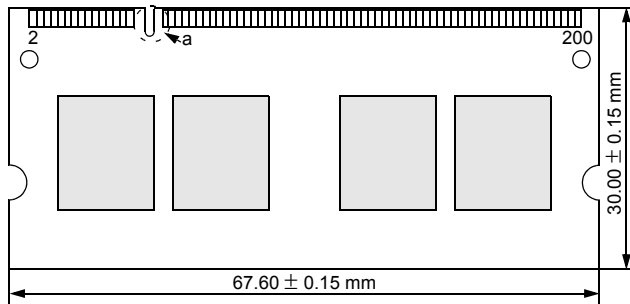
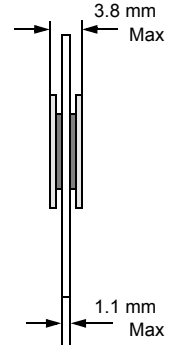
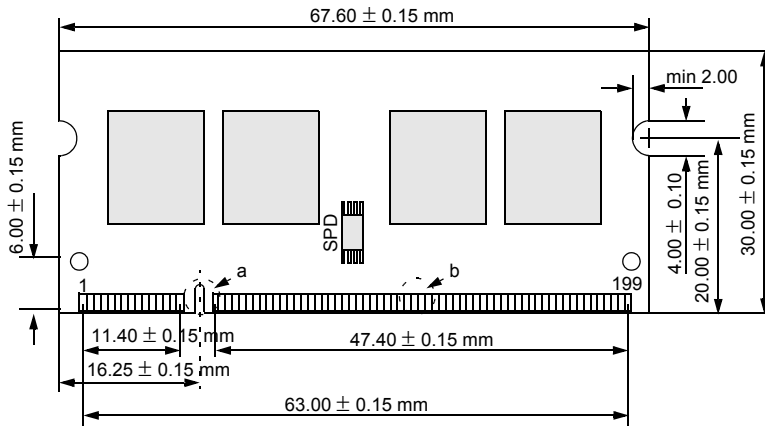

DETAIL a

DETAIL b

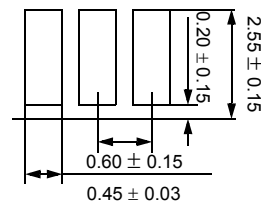
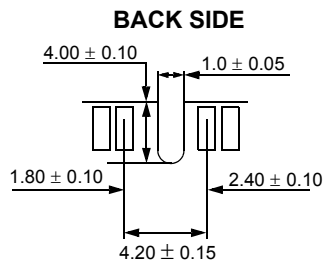
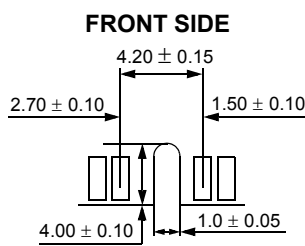

The used device is 128M x8 DDR2 SDRAM, FBGA.  
DDR2 SDRAM Part NO : K4T1G084QE

14.4 64Mbx16 based 64Mx64 Module (1 Rank)

Units : Millimeters

- M470T6464EHS

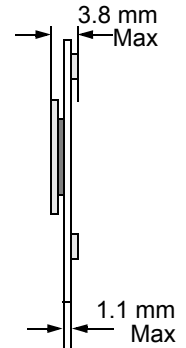
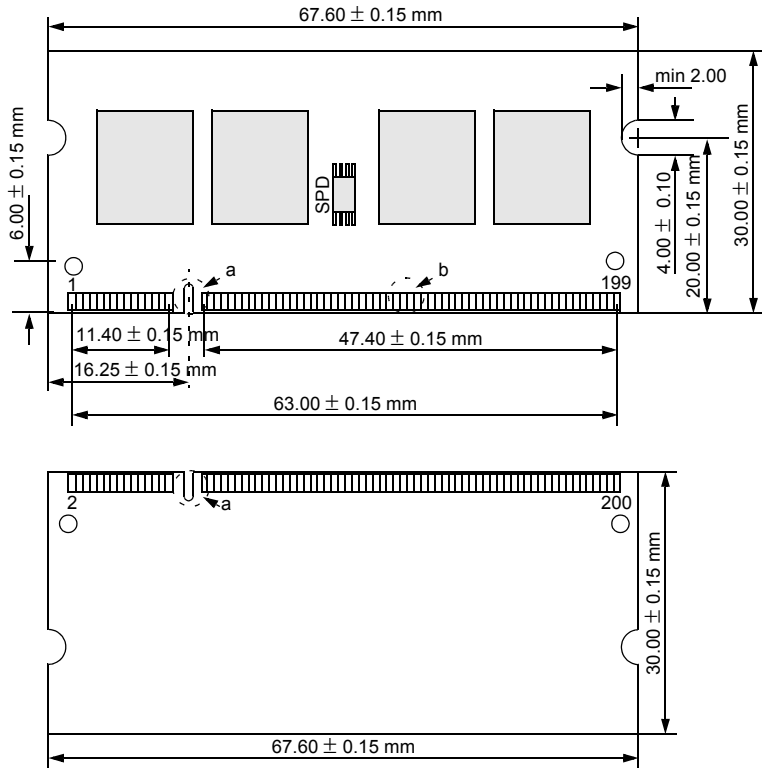

DETAIL a

DETAIL b

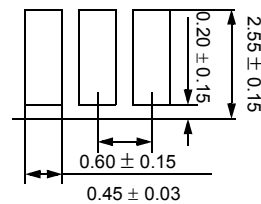
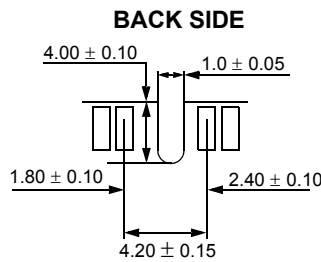
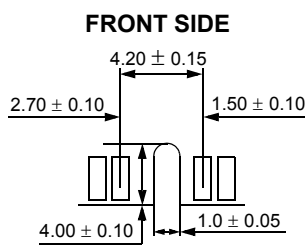

The used device is 64M x16 DDR2 SDRAM, FBGA.  
DDR2 SDRAM Part NO : K4T1G164QE