

# 204pin Unbuffered SODIMM based on 2Gb D-die

78FBGA with Lead-Free & Halogen-Free  
(RoHS compliant)

## datasheet

SAMSUNG ELECTRONICS RESERVES THE RIGHT TO CHANGE PRODUCTS, INFORMATION AND SPECIFICATIONS WITHOUT NOTICE.

Products and specifications discussed herein are for reference purposes only. All information discussed herein is provided on an "AS IS" basis, without warranties of any kind.

This document and all information discussed herein remain the sole and exclusive property of Samsung Electronics. No license of any patent, copyright, mask work, trademark or any other intellectual property right is granted by one party to the other party under this document, by implication, estoppel or otherwise.

Samsung products are not intended for use in life support, critical care, medical, safety equipment, or similar applications where product failure could result in loss of life or personal or physical harm, or any military or defense application, or any governmental procurement to which special terms or provisions may apply.

For updates or additional information about Samsung products, contact your nearest Samsung office.

All brand names, trademarks and registered trademarks belong to their respective owners.

© 2010 Samsung Electronics Co., Ltd. All rights reserved.

## Revision History

<u>Revision No.</u>	<u>History</u>	<u>Draft Date</u>	<u>Remark</u>	<u>Editor</u>
1.0	- First Release	Aug. 2010	-	S.H.Kim
1.01	- Changed note comment on page. 27, 35	Aug. 2010	-	S.H.Kim
1.1	- Corrected IDD current spec.(IDD7)	Sep. 2010	-	S.H.Kim
1.2	- Changed Input/Output capacitance on page 21.	Sep. 2010	-	S.H.Kim
1.3	- Changed 1866 speed bin table on page 26.	Nov. 2010	-	S.H.Kim
1.31	- Corrected typo.	Dec. 2010	-	S.H.Kim

**Table Of Contents**

**204pin Unbuffered SODIMM based on 2Gb D-die**

1. DDR3 Unbuffered SODIMM Ordering Information.....	4
2. Key Features.....	4
3. Address Configuration .....	4
4. x64 DIMM Pin Configurations (Front side/Back Side).....	5
5. Pin Description .....	6
6. Input/Output Functional Description.....	7
7. Function Block Diagram:.....	8
7.1 2GB, 256Mx64 Module (Populated as 1 rank of x8 DDR3 SDRAMs) .....	8
7.2 4GB, 512Mx64 Module (Populated as 2 ranks of x8 DDR3 SDRAMs) .....	9
8. Absolute Maximum Ratings .....	10
8.1 Absolute Maximum DC Ratings.....	10
8.2 DRAM Component Operating Temperature Range .....	10
9. AC & DC Operating Conditions.....	10
9.1 Recommended DC Operating Conditions (SSTL-15).....	10
10. AC & DC Input Measurement Levels .....	11
10.1 AC & DC Logic Input Levels for Single-ended Signals .....	11
10.2 V <sub>REF</sub> Tolerances.....	12
10.3 AC and DC Logic Input Levels for Differential Signals .....	13
10.3.1. Differential Signals Definition .....	13
10.3.2. Differential Swing Requirement for Clock (CK-CK) and Strobe (DQS-DQS) .....	13
10.3.3. Single-ended Requirements for Differential Signals .....	14
10.3.4. Differential Input Cross Point Voltage .....	15
10.4 Slew Rate Definition for Single Ended Input Signals.....	15
10.5 Slew rate definition for Differential Input Signals .....	15
11. AC & DC Output Measurement Levels .....	16
11.1 Single Ended AC and DC Output Levels.....	16
11.2 Differential AC and DC Output Levels .....	16
11.3 Single-ended Output Slew Rate .....	16
11.4 Differential Output Slew Rate .....	17
12. DIMM IDD specification definition .....	18
13. IDD SPEC Table .....	20
14. Input/Output Capacitance .....	21
15. Electrical Characteristics and AC timing .....	22
15.1 Refresh Parameters by Device Density.....	22
15.2 Speed Bins and CL, tRCD, tRP, tRC and tRAS for Corresponding Bin .....	22
15.3 Speed Bins and CL, tRCD, tRP, tRC and tRAS for corresponding Bin .....	22
15.3.1. Speed Bin Table Notes .....	27
16. Timing Parameters by Speed Grade .....	28
16.1 Jitter Notes .....	34
16.2 Timing Parameter Notes.....	35
17. Physical Dimensions :.....	36
17.1 256Mbx8 based 256Mx64 Module (1 Rank) - M471B5773DH0 .....	36
17.2 256Mbx8 based 512Mx64 Module (2 Ranks) - M471B5273DH0 .....	37

## 1. DDR3 Unbuffered SODIMM Ordering Information

Part Number <sup>2</sup>	Density	Organization	Component Composition	Number of Rank	Height
M471B5773DH0-CF8/H9/K0/MA	2GB	256Mx64	256Mx8(K4B2G0846D-HC##)*8	1	30mm
M471B5273DH0-CF8/H9/K0/MA	4GB	512Mx64	256Mx8(K4B2G0846D-HC##)*16	2	30mm

### NOTE :

- "##" - F8/H9/K0/MA
- F8 - 1066Mbps 7-7-7 / H9 - 1333Mbps 9-9-9 / K0 - 1600Mbps 11-11-11 / MA - 1866Mbps 13-13-13
  - DDR3-1866(13-13-13) is backward compatible to DDR3-1600(11-11-11), DDR3-1333(9-9-9), DDR3-1066(7-7-7)
  - DDR3-1600(11-11-11) is backward compatible to DDR3-1333(9-9-9), DDR3-1066(7-7-7)
  - DDR3-1333(9-9-9) is backward compatible to DDR3-1066(7-7-7)

## 2. Key Features

Speed	DDR3-800	DDR3-1066	DDR3-1333	DDR3-1600	DDR3-1866	Unit
	6-6-6	7-7-7	9-9-9	11-11-11	13-13-13	
tCK(min)	2.5	1.875	1.5	1.25	1.07	ns
CAS Latency	6	7	9	11	13	tCK
tRCD(min)	15	13.125	13.5	13.75	13.91	ns
tRP(min)	15	13.125	13.5	13.75	13.91	ns
tRAS(min)	37.5	37.5	36	35	34	ns
tRC(min)	52.5	50.625	49.5	48.75	47.91	ns

- JEDEC standard 1.5V ± 0.075V Power Supply
- $V_{DDQ} = 1.5V \pm 0.075V$
- 400MHz  $f_{CK}$  for 800Mb/sec/pin, 533MHz  $f_{CK}$  for 1066Mb/sec/pin, 667MHz  $f_{CK}$  for 1333Mb/sec/pin, 800MHz  $f_{CK}$  for 1600Mb/sec/pin, 900MHz  $f_{CK}$  for 1866Mb/sec/pin
- 8 independent internal bank
- Programmable CAS Latency: 5,6,7,8,9,10,11,13
- Programmable Additive Latency(Posted CAS) : 0, CL - 2, or CL - 1 clock
- Programmable CAS Write Latency(CWL) = 5 (DDR3-800), 6 (DDR3-1066), 7 (DDR3-1333), 8 (DDR3-1600) and 9 (DDR3-1866)
- Burst Length: 8 (Interleave without any limit, sequential with starting address "000" only), 4 with tCCD = 4 which does not allow seamless read or write [either On the fly using A12 or MRS]
- Bi-directional Differential Data Strobe
- On Die Termination using ODT pin
- Average Refresh Period 7.8us at lower then  $T_{CASE} 85^{\circ}C$ , 3.9us at  $85^{\circ}C < T_{CASE} \leq 95^{\circ}C$
- Asynchronous Reset

## 3. Address Configuration

Organization	Row Address	Column Address	Bank Address	Auto Precharge
256Mx8(2Gb) based Module	A0-A14	A0-A9	BA0-BA2	A10/AP

### 4. x64 DIMM Pin Configurations (Front side/Back Side)

Pin	Front	Pin	Back	Pin	Front	Pin	Back	Pin	Front	Pin	Back
1	V <sub>REFDQ</sub>	2	V <sub>SS</sub>	71	V <sub>SS</sub>	72	V <sub>SS</sub>	139	V <sub>SS</sub>	140	DQ38
3	V <sub>SS</sub>	4	DQ4	KEY				141	DQ34	142	DQ39
5	DQ0	6	DQ5	73	CKE0	74	CKE1	143	DQ35	144	V <sub>SS</sub>
7	DQ1	8	V <sub>SS</sub>	75	V <sub>DD</sub>	76	V <sub>DD</sub>	145	V <sub>SS</sub>	146	DQ44
9	V <sub>SS</sub>	10	$\overline{\text{DQS0}}$	77	NC	78	A15 <sup>3</sup>	147	DQ40	148	DQ45
11	DM0	12	DQS0	79	BA2	80	A14 <sup>3</sup>	149	DQ41	150	V <sub>SS</sub>
13	V <sub>SS</sub>	14	V <sub>SS</sub>	81	V <sub>DD</sub>	82	V <sub>DD</sub>	151	V <sub>SS</sub>	152	$\overline{\text{DQS5}}$
15	DQ2	16	DQ6	83	A12/ $\overline{\text{BC}}$	84	A11	153	DM5	154	DQS5
17	DQ3	18	DQ7	85	A9	86	A7	155	V <sub>SS</sub>	156	V <sub>SS</sub>
19	V <sub>SS</sub>	20	V <sub>SS</sub>	87	V <sub>DD</sub>	88	V <sub>DD</sub>	157	DQ42	158	DQ46
21	DQ8	22	DQ12	89	A8	90	A6	159	DQ43	160	DQ47
23	DQ9	24	DQ13	91	A5	92	A4	161	V <sub>SS</sub>	162	V <sub>SS</sub>
25	V <sub>SS</sub>	26	V <sub>SS</sub>	93	V <sub>DD</sub>	94	V <sub>DD</sub>	163	DQ48	164	DQ52
27	$\overline{\text{DQS1}}$	28	DM1	95	A3	96	A2	165	DQ49	166	DQ53
29	DQS1	30	$\overline{\text{RESET}}$	97	A1	98	A0	167	V <sub>SS</sub>	168	V <sub>SS</sub>
31	V <sub>SS</sub>	32	V <sub>SS</sub>	99	V <sub>DD</sub>	100	V <sub>DD</sub>	169	$\overline{\text{DQS6}}$	170	DM6
33	DQ10	34	DQ14	101	CK0	102	CK1	171	DQS6	172	V <sub>SS</sub>
35	DQ11	36	DQ15	103	$\overline{\text{CK0}}$	104	$\overline{\text{CK1}}$	173	V <sub>SS</sub>	174	DQ54
37	V <sub>SS</sub>	38	V <sub>SS</sub>	105	V <sub>DD</sub>	106	V <sub>DD</sub>	175	DQ50	176	DQ55
39	DQ16	40	DQ20	107	A10/AP	108	BA1	177	DQ51	178	V <sub>SS</sub>
41	DQ17	42	DQ21	109	BA0	110	$\overline{\text{RAS}}$	179	V <sub>SS</sub>	180	DQ60
43	V <sub>SS</sub>	44	V <sub>SS</sub>	111	V <sub>DD</sub>	112	V <sub>DD</sub>	181	DQ56	182	DQ61
45	$\overline{\text{DQS2}}$	46	DM2	113	$\overline{\text{WE}}$	114	$\overline{\text{S0}}$	183	DQ57	184	V <sub>SS</sub>
47	DQS2	48	V <sub>SS</sub>	115	$\overline{\text{CAS}}$	116	ODT0	185	V <sub>SS</sub>	186	$\overline{\text{DQS7}}$
49	V <sub>SS</sub>	50	DQ22	117	V <sub>DD</sub>	118	V <sub>DD</sub>	187	DM7	188	DQS7
50	DQ18	52	DQ23	119	A13 <sup>3</sup>	120	ODT1	189	V <sub>SS</sub>	190	V <sub>SS</sub>
53	DQ19	54	V <sub>SS</sub>	121	$\overline{\text{S1}}$	122	NC	191	DQ58	192	DQ62
55	V <sub>SS</sub>	56	DQ28	123	V <sub>DD</sub>	124	V <sub>DD</sub>	193	DQ59	194	DQ63
57	DQ24	58	DQ29	125	TEST	126	V <sub>REFCA</sub>	195	V <sub>SS</sub>	196	V <sub>SS</sub>
59	DQ25	60	V <sub>SS</sub>	127	V <sub>SS</sub>	128	V <sub>SS</sub>	197	SA0	198	NC
61	V <sub>SS</sub>	62	$\overline{\text{DQS3}}$	129	DQ32	130	DQ36	199	V <sub>DDSPD</sub>	200	SDA
63	DM3	64	DQS3	131	DQ33	132	DQ37	201	SA1	202	SCL
65	V <sub>SS</sub>	66	V <sub>SS</sub>	133	V <sub>SS</sub>	134	V <sub>SS</sub>	203	V <sub>TT</sub>	204	V <sub>TT</sub>
67	DQ26	68	DQ30	135	$\overline{\text{DQS4}}$	136	DM4				
69	DQ27	70	DQ31	137	DQS4	138	V <sub>SS</sub>				

- NOTE :**  
 1. NC = No Connect, NU = Not Usable, RFU = Reserved Future Use  
 2. TEST(pin 125) is reserved for bus analysis probes and is NC on normal memory modules.  
 3. This address might be connected to NC balls of the DRAMs (depending on density); either way they will be connected to the termination resistor.

SAMSUNG ELECTRONICS CO., Ltd. reserves the right to change products and specifications without notice.



## 5. Pin Description

Pin Name	Description	Number	Pin Name	Description	Number
CK0, CK1	Clock Inputs, positive line	2	DQ0-DQ63	Data Input/Output	64
$\overline{\text{CK0}}, \overline{\text{CK1}}$	Clock Inputs, negative line	2	DM0-DM7	Data Masks/ Data strobes, Termination data strobes	8
CKE0, CKE1	Clock Enables	2	DQS0-DQS7	Data strobes	8
$\overline{\text{RAS}}$	Row Address Strobe	1	$\overline{\text{DQS0}}-\overline{\text{DQS7}}$	Data strobes complement	8
$\overline{\text{CAS}}$	Column Address Strobe	1	$\overline{\text{RESET}}$	Reset Pin	1
$\overline{\text{WE}}$	Write Enable	1	TEST	Logic Analyzer specific test pin (No connect on SODIMM)	1
$\overline{\text{S0}}, \overline{\text{S1}}$	Chip Selects	2	V <sub>DD</sub>	Core and I/O Power	18
A0-A9, A11, A13-A15	Address Inputs	14	V <sub>SS</sub>	Ground	52
A10/AP	Address Input/Autoprecharge	1	V <sub>REFDQ</sub> V <sub>REFCA</sub>	Input/Output Reference	2
A12/ $\overline{\text{BC}}$	Address Input/Burst chop	1	V <sub>DDSPD</sub>	SPD and Temp sensor Power	1
BA0-BA2	SDRAM Bank Addresses	3	V <sub>TT</sub>	Termination Voltage	2
ODT0, ODT1	On-die termination control	2	NC	Reserved for future use	3
SCL	Serial Presence Detect (SPD) Clock Input	1		Total	204
SDA	SPD Data Input/Output	1			
SA0-SA1	SPD Address	2			

**NOTE:**

\*The V<sub>DD</sub> and V<sub>DDQ</sub> pins are tied common to a single power-plane on these designs.

## 6. Input/Output Functional Description

Symbol	Type	Function
$\overline{CK0-CK1}$ $\overline{CK0-CK1}$	Input	The system clock inputs. All address and command lines are sampled on the cross point of the rising edge of CK and falling edge of CK. A Delay Locked Loop (DLL) circuit is driven from the clock inputs and output timing for read operations is synchronized to the input clock.
CKE0-CKE1	Input	Activates the DDR3 SDRAM CK signal when high and deactivates the CK signal when low. By deactivating the clocks, CKE low initiates the Power Down mode or the Self Refresh mode.
$\overline{S0-S1}$	Input	Enables the associated DDR3 SDRAM command decoder when low and disables the command decoder when high. When the command decoder is disabled, new commands are ignored but previous operations continue. Rank 0 is selected by $\overline{S0}$ ; Rank 1 is selected by $\overline{S1}$ .
$\overline{RAS}$ , $\overline{CAS}$ , $\overline{WE}$	Input	When sampled at the cross point of the rising edge of CK and falling edge of $\overline{CK}$ , signals $\overline{CAS}$ , $\overline{RAS}$ , and $\overline{WE}$ define the operation to be executed by the SDRAM.
BA0-BA2	Input	Selects which DDR3 SDRAM internal bank of eight is activated.
ODT0-ODT1	Input	Asserts on-die termination for DQ, DM, DQS, and DQS signals if enabled via the DDR3 SDRAM mode register.
A0-A9, A10/AP, A11 A12/BC A13-A15	Input	During a Bank Activate command cycle, defines the row address when sampled at the cross point of the rising edge of CK and falling edge of CK. During a Read or Write command cycle, defines the column address when sampled at the cross point of the rising edge of CK and falling edge of $\overline{CK}$ . In addition to the column address, AP is used to invoke autoprecharge operation at the end of the burst read or write cycle. If AP is high, autoprecharge is selected and BA0-BAn defines the bank to be precharged. If AP is low, autoprecharge is disabled. During a Precharge command cycle, AP is used in conjunction with BA0-BAn to control which bank(s) to precharge. If AP is high, all banks will be precharged regardless of the state of BA0-BAn inputs. If AP is low, then BA0-BAn are used to define which bank to precharge. A12(BC) is sampled during READ and WRITE commands to determine if burst chop (on-the fly) will be performed (HIGH, no burst chop; LOW, burst chopped)
DQ0-DQ63	I/O	Data Input/Output pins.
DM0-DM7	Input	The data write masks, associated with one data byte. In Write mode, DM operates as a byte mask by allowing input data to be written if it is low but blocks the write operation if it is high. In Read mode, DM lines have no effect.
$\overline{DQS0-DQS7}$ $\overline{DQS0-DQS7}$	I/O	The data strobes, associated with one data byte, sourced with data transfers. In Write mode, the data strobe is sourced by the controller and is centered in the data window. In Read mode, the data strobe is sourced by the DDR3 SDRAMs and is sent at the leading edge of the data window. DQS signals are complements, and timing is relative to the crosspoint of respective DQS and $\overline{DQS}$ .
$V_{DD}$ , $V_{DDSPD}$ , $V_{SS}$	Supply	Power supplies for core, I/O, Serial Presence Detect, Temp sensor, and ground for the module.
$V_{REFDQ}$ , $V_{REFCA}$	Supply	Reference voltage for SSTL15 inputs.
SDA	I/O	This is a bidirectional pin used to transfer data into or out of the SPD EEPROM and Temp sensor. A resistor must be connected from the SDA bus line to $V_{DDSPD}$ on the system planar to act as a pull up.
SCL	Input	This signal is used to clock data into and out of the SPD EEPROM and Temp sensor.
SA0-SA1	Input	Address pins used to select the Serial Presence Detect and Temp sensor base address.
TEST	I/O	The TEST pin is reserved for bus analysis tools and is not connected on normal memory modules
$\overline{RESET}$	Input	$\overline{RESET}$ In Active Low This signal resets the DDR3 SDRAM

## 7. Function Block Diagram:

### 7.1 2GB, 256Mx64 Module (Populated as 1 rank of x8 DDR3 SDRAMs)

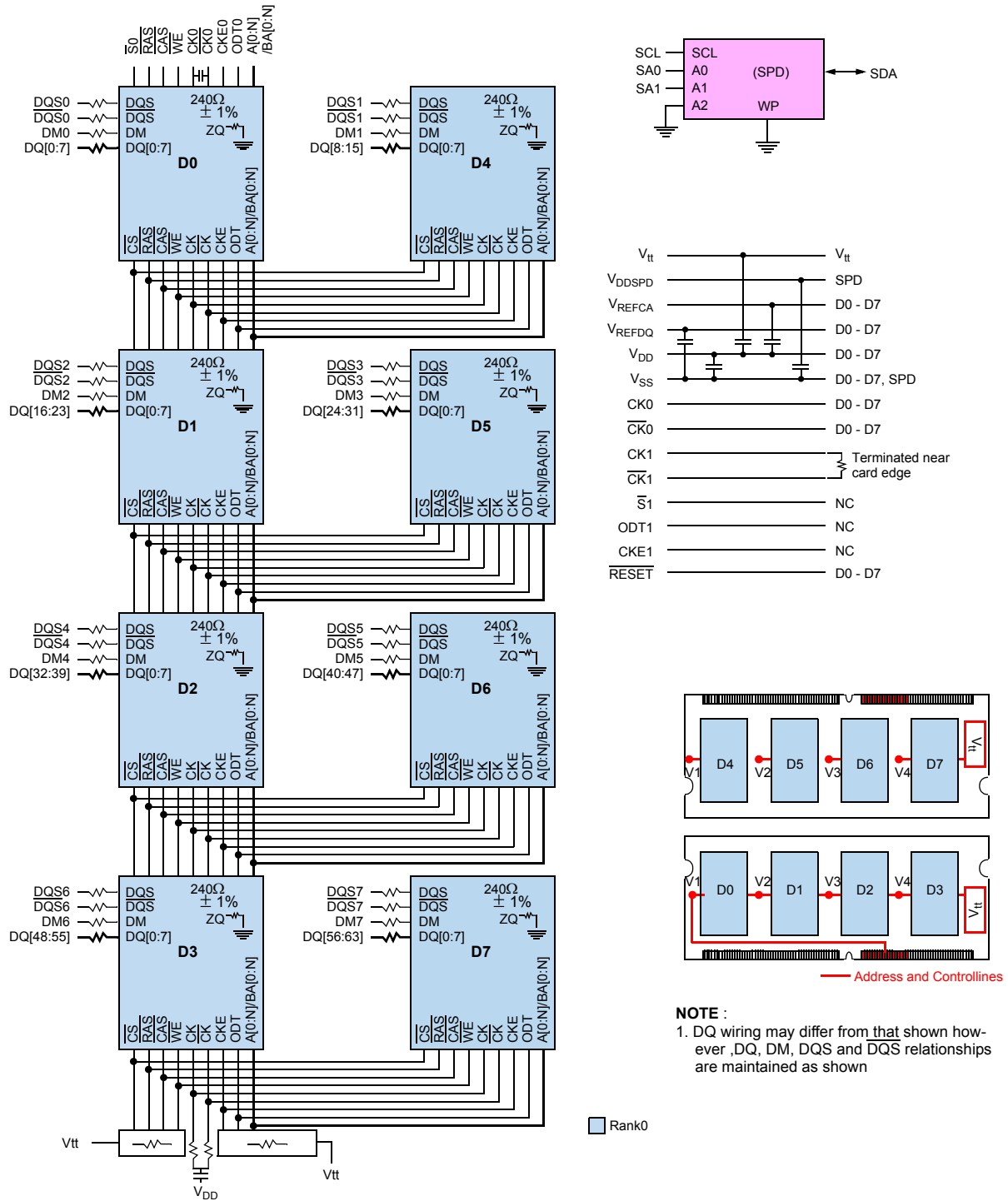



7.2 4GB, 512Mx64 Module (Populated as 2 ranks of x8 DDR3 SDRAMs)

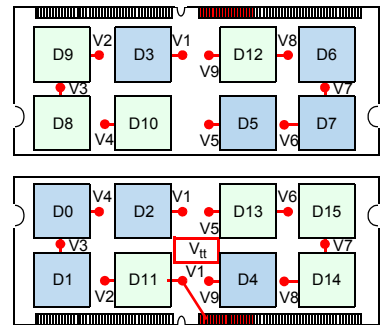
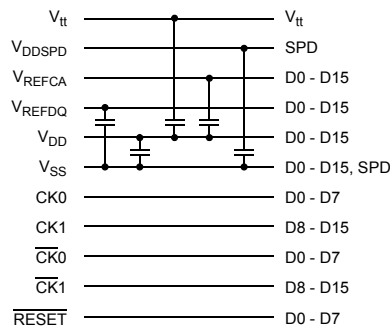
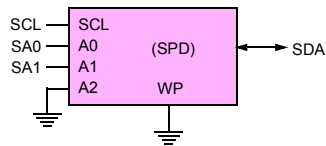
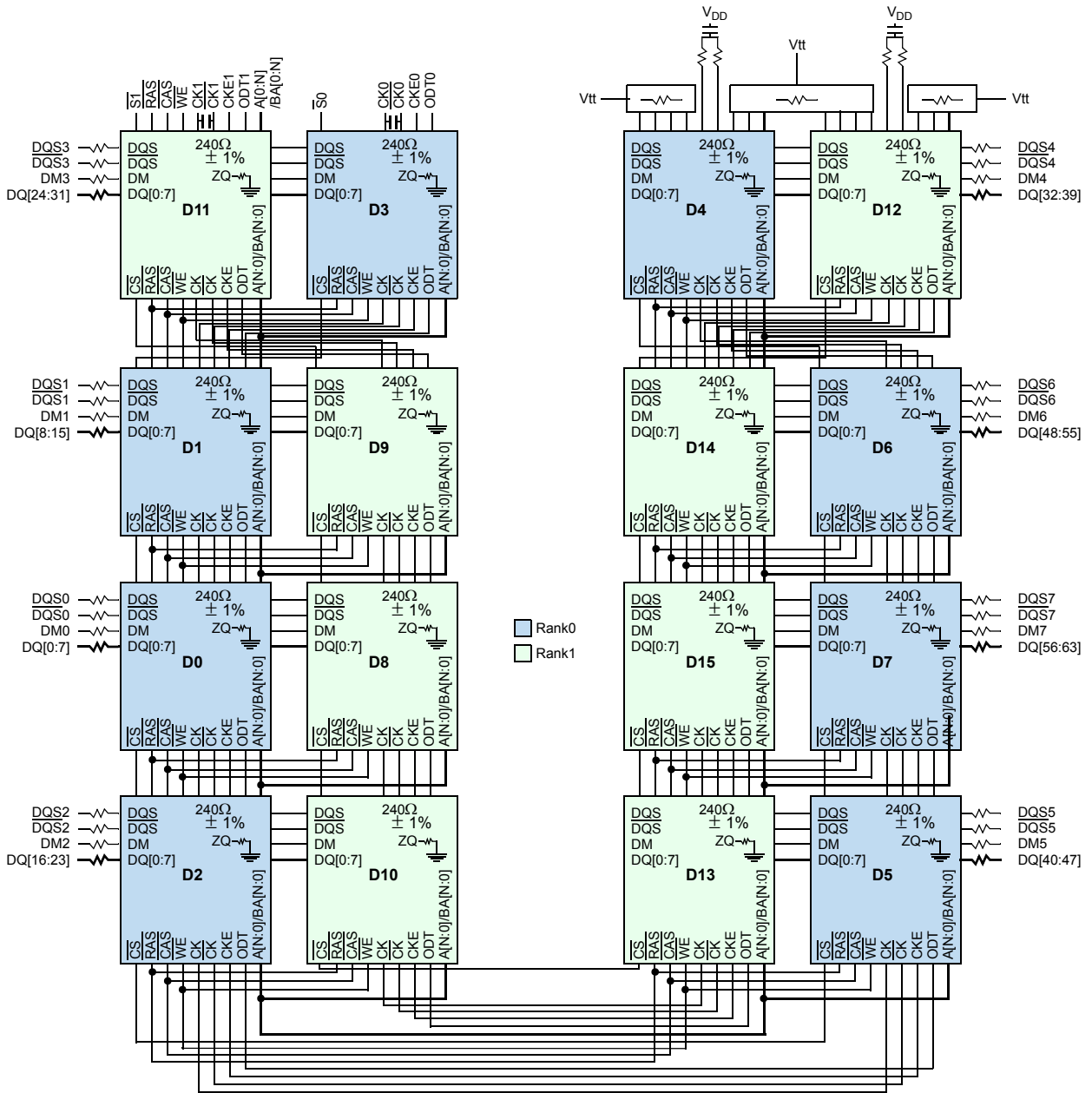

— Address and Control lines

## 8. Absolute Maximum Ratings

### 8.1 Absolute Maximum DC Ratings

Symbol	Parameter	Rating	Units	NOTE
$V_{DD}$	Voltage on $V_{DD}$ pin relative to $V_{SS}$	-0.4 V ~ 1.975 V	V	1,3
$V_{DDQ}$	Voltage on $V_{DDQ}$ pin relative to $V_{SS}$	-0.4 V ~ 1.975 V	V	1,3
$V_{IN}, V_{OUT}$	Voltage on any pin relative to $V_{SS}$	-0.4 V ~ 1.975 V	V	1
$T_{STG}$	Storage Temperature	-55 to +100	°C	1, 2

- NOTE :**
- Stresses greater than those listed under "Absolute Maximum Ratings" may cause permanent damage to the device. This is a stress rating only and functional operation of the device at these or any other conditions above those indicated in the operational sections of this specification is not implied. Exposure to absolute maximum rating conditions for extended periods may affect reliability.
  - Storage Temperature is the case surface temperature on the center/top side of the DRAM. For the measurement conditions, please refer to JESD51-2 standard.
  - $V_{DD}$  and  $V_{DDQ}$  must be within 300mV of each other at all times; and  $V_{REF}$  must be not greater than  $0.6 \times V_{DDQ}$ . When  $V_{DD}$  and  $V_{DDQ}$  are less than 500mV;  $V_{REF}$  may be equal to or less than 300mV.

### 8.2 DRAM Component Operating Temperature Range

Symbol	Parameter	rating	Unit	NOTE
$T_{OPER}$	Operating Temperature Range	0 to 95	°C	1, 2, 3

- NOTE :**
- Operating Temperature  $T_{OPER}$  is the case surface temperature on the center/top side of the DRAM. For measurement conditions, please refer to the JEDEC document JESD51-2.
  - The Normal Temperature Range specifies the temperatures where all DRAM specifications will be supported. During operation, the DRAM case temperature must be maintained between 0-85°C under all operating conditions
  - Some applications require operation of the Extended Temperature Range between 85°C and 95°C case temperature. Full specifications are guaranteed in this range, but the following additional conditions apply:
    - Refresh commands must be doubled in frequency, therefore reducing the refresh interval  $t_{REFI}$  to 3.9 $\mu$ s.
    - If Self-Refresh operation is required in the Extended Temperature Range, then it is mandatory to either use the Manual Self-Refresh mode with Extended Temperature Range capability (MR2 A6 = 0b and MR2 A7 = 1b), in this case  $I_{DD6}$  current can be increased around 10~20% than normal Temperature range.

## 9. AC & DC Operating Conditions

### 9.1 Recommended DC Operating Conditions (SSTL-15)

Symbol	Parameter	Rating			Units	NOTE
		Min.	Typ.	Max.		
$V_{DD}$	Supply Voltage	1.425	1.5	1.575	V	1,2
$V_{DDQ}$	Supply Voltage for Output	1.425	1.5	1.575	V	1,2

- NOTE:**
- Under all conditions  $V_{DDQ}$  must be less than or equal to  $V_{DD}$ .
  - $V_{DDQ}$  tracks with  $V_{DD}$ . AC parameters are measured with  $V_{DD}$  and  $V_{DDQ}$  tied together.

## 10. AC & DC Input Measurement Levels

### 10.1 AC & DC Logic Input Levels for Single-ended Signals

[ Table 1 ] Single-ended AC & DC input levels for Command and Address

Symbol	Parameter	DDR3-800/1066/1333/1600		DDR3-1866		Unit	NOTE
		Min.	Max.	Min.	Max.		
V <sub>IH,CA</sub> (DC100)	DC input logic high	V <sub>REF</sub> + 100	V <sub>DD</sub>	V <sub>REF</sub> + 100	V <sub>DD</sub>	mV	1,5
V <sub>IL,CA</sub> (DC100)	DC input logic low	V <sub>SS</sub>	V <sub>REF</sub> - 100	V <sub>SS</sub>	V <sub>REF</sub> - 100	mV	1,6
V <sub>IH,CA</sub> (AC175)	AC input logic high	V <sub>REF</sub> + 175	Note 2	-	-	mV	1,2,7
V <sub>IL,CA</sub> (AC175)	AC input logic low	Note 2	V <sub>REF</sub> - 175	-	-	mV	1,2,8
V <sub>IH,CA</sub> (AC150)	AC input logic high	V <sub>REF</sub> +150	Note 2	-	-	mV	1,2,7
V <sub>IL,CA</sub> (AC150)	AC input logic low	Note 2	V <sub>REF</sub> -150	-	-	mV	1,2,8
V <sub>IH,CA</sub> (AC135)	AC input logic high	-	-	V <sub>REF</sub> + 135	Note 2	mV	1,2,7
V <sub>IL,CA</sub> (AC135)	AC input logic low	-	-	Note 2	V <sub>REF</sub> - 135	mV	1,2,8
V <sub>IH,CA</sub> (AC125)	AC input logic high	-	-	V <sub>REF</sub> +125	Note 2	mV	1,2,7
V <sub>IL,CA</sub> (AC125)	AC input logic low	-	-	Note 2	V <sub>REF</sub> -125	mV	1,2,8
V <sub>REFCA</sub> (DC)	Reference Voltage for ADD, CMD inputs	0.49*V <sub>DD</sub>	0.51*V <sub>DD</sub>	0.49*V <sub>DD</sub>	0.51*V <sub>DD</sub>	V	3,4

**NOTE :**

- For input only pins except  $\overline{\text{RESET}}$ , V<sub>REF</sub> = V<sub>REFCA</sub>(DC)
- See 'Overshoot/Undershoot Specification' on page 18.
- The AC peak noise on V<sub>REF</sub> may not allow V<sub>REF</sub> to deviate from V<sub>REF</sub>(DC) by more than ± 1% V<sub>DD</sub> (for reference : approx. ± 15mV)
- For reference : approx. V<sub>DD</sub>/2 ± 15mV
- V<sub>IH</sub>(dc) is used as a simplified symbol for V<sub>IH,CA</sub>(DC100)
- V<sub>IL</sub>(dc) is used as a simplified symbol for V<sub>IL,CA</sub>(DC100)
- V<sub>IH</sub>(ac) is used as a simplified symbol for V<sub>IH,CA</sub>(AC175), V<sub>IH,CA</sub>(AC150), V<sub>IH,CA</sub>(AC135) and V<sub>IH,CA</sub>(AC125); V<sub>IH,CA</sub>(AC175) value is used when V<sub>REF</sub> + 175mV is referenced, V<sub>IH,CA</sub>(AC150) value is used when V<sub>REF</sub> + 150mV is referenced, V<sub>IH,CA</sub>(AC135) value is used when V<sub>REF</sub> + 135mV is referenced and V<sub>IH,CA</sub>(AC125) value is used when V<sub>REF</sub> + 125mV is referenced.
- V<sub>IL</sub>(ac) is used as a simplified symbol for V<sub>IL,CA</sub>(AC175) and V<sub>IL,CA</sub>(AC150), V<sub>IL,CA</sub>(AC135) and V<sub>IL,CA</sub>(AC125); V<sub>IL,CA</sub>(AC175) value is used when V<sub>REF</sub> - 175mV is referenced, V<sub>IL,CA</sub>(AC150) value is used when V<sub>REF</sub> - 150mV is referenced, V<sub>IL,CA</sub>(AC135) value is used when V<sub>REF</sub> - 135mV is referenced and V<sub>IL,CA</sub>(AC125) value is used when V<sub>REF</sub> - 125mV is referenced.

[ Table 2 ] Single-ended AC & DC input levels for DQ and DM

Symbol	Parameter	DDR3-800/1066		DDR3-1333/1600		DDR3-1866		Unit	NOTE
		Min.	Max.	Min.	Max.	Min.	Max.		
V <sub>IH,DQ</sub> (DC100)	DC input logic high	V <sub>REF</sub> + 100	V <sub>DD</sub>	V <sub>REF</sub> + 100	V <sub>DD</sub>	V <sub>REF</sub> + 100	V <sub>DD</sub>	mV	1,5
V <sub>IL,DQ</sub> (DC100)	DC input logic low	V <sub>SS</sub>	V <sub>REF</sub> - 100	V <sub>SS</sub>	V <sub>REF</sub> - 100	V <sub>SS</sub>	V <sub>REF</sub> - 100	mV	1,6
V <sub>IH,DQ</sub> (AC175)	AC input logic high	V <sub>REF</sub> + 175	NOTE 2	-	-	-	-	mV	1,2,7
V <sub>IL,DQ</sub> (AC175)	AC input logic low	NOTE 2	V <sub>REF</sub> - 175	-	-	-	-	mV	1,2,8
V <sub>IH,DQ</sub> (AC150)	AC input logic high	V <sub>REF</sub> + 150	NOTE 2	V <sub>REF</sub> + 150	NOTE 2	-	-	mV	1,2,7
V <sub>IL,DQ</sub> (AC150)	AC input logic low	NOTE 2	V <sub>REF</sub> - 150	NOTE 2	V <sub>REF</sub> - 150	-	-	mV	1,2,8
V <sub>IH,DQ</sub> (AC135)	AC input logic high	-	-	-	-	V <sub>REF</sub> + 135	NOTE 2	mV	1,2,7
V <sub>IL,DQ</sub> (AC135)	AC input logic low	-	-	-	-	NOTE 2	V <sub>REF</sub> - 135	mV	1,2,8
V <sub>REFDQ</sub> (DC)	Reference Voltage for DQ, DM inputs	0.49*V <sub>DD</sub>	0.51*V <sub>DD</sub>	0.49*V <sub>DD</sub>	0.51*V <sub>DD</sub>	0.49*V <sub>DD</sub>	0.51*V <sub>DD</sub>	V	3,4

**NOTE :**

- For input only pins except  $\overline{\text{RESET}}$ , V<sub>REF</sub> = V<sub>REFDQ</sub>(DC)
- See 'Overshoot/Undershoot Specification' on page 18.
- The AC peak noise on V<sub>REF</sub> may not allow V<sub>REF</sub> to deviate from V<sub>REF</sub>(DC) by more than ± 1% V<sub>DD</sub> (for reference : approx. ± 15mV)
- For reference : approx. V<sub>DD</sub>/2 ± 15mV
- V<sub>IH</sub>(dc) is used as a simplified symbol for V<sub>IH,DQ</sub>(DC100)
- V<sub>IL</sub>(dc) is used as a simplified symbol for V<sub>IL,DQ</sub>(DC100)
- V<sub>IH</sub>(ac) is used as a simplified symbol for V<sub>IH,DQ</sub>(AC175), V<sub>IH,DQ</sub>(AC150) and V<sub>IH,DQ</sub>(AC135) ; V<sub>IH,DQ</sub>(AC175) value is used when V<sub>REF</sub> + 175mV is referenced, V<sub>IH,DQ</sub>(AC150) value is used when V<sub>REF</sub> + 150mV is referenced.
- V<sub>IL</sub>(ac) is used as a simplified symbol for V<sub>IL,DQ</sub>(AC175), V<sub>IL,DQ</sub>(AC150) ; V<sub>IL,DQ</sub>(AC175) value is used when V<sub>REF</sub> - 175mV is referenced, V<sub>IL,DQ</sub>(AC150) value is used when V<sub>REF</sub> - 150mV is referenced.

## 10.2 V<sub>REF</sub> Tolerances.

The dc-tolerance limits and ac-noise limits for the reference voltages V<sub>REFCA</sub> and V<sub>REFDQ</sub> are illustrate in Figure 1. It shows a valid reference voltage V<sub>REF</sub>(t) as a function of time. (V<sub>REF</sub> stands for V<sub>REFCA</sub> and V<sub>REFDQ</sub> likewise).

V<sub>REF</sub>(DC) is the linear average of V<sub>REF</sub>(t) over a very long period of time (e.g. 1 sec). This average has to meet the min/max requirements of V<sub>REF</sub>. Furthermore V<sub>REF</sub>(t) may temporarily deviate from V<sub>REF</sub>(DC) by no more than ± 1% V<sub>DD</sub>.

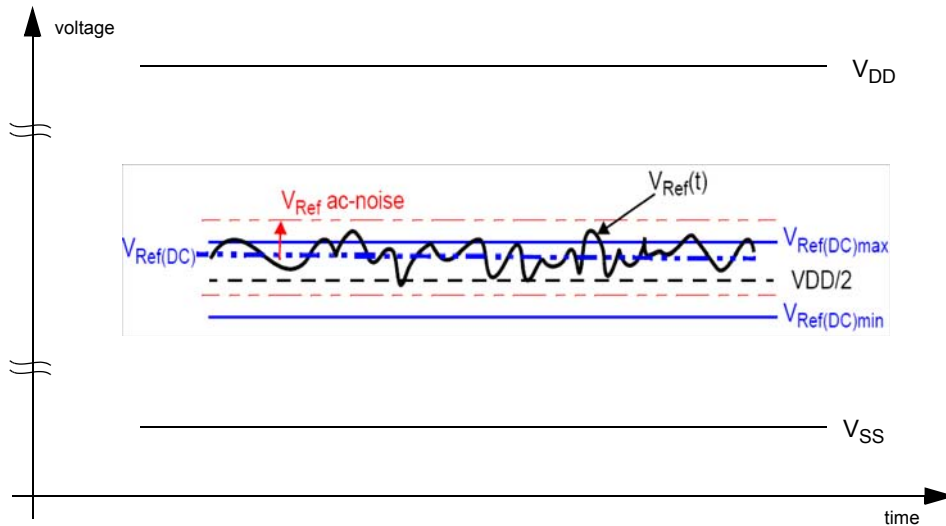

**Figure 1. Illustration of VREF(DC) tolerance and VREF ac-noise limits**

The voltage levels for setup and hold time measurements V<sub>IH</sub>(AC), V<sub>IH</sub>(DC), V<sub>IL</sub>(AC) and V<sub>IL</sub>(DC) are dependent on V<sub>REF</sub>.

"V<sub>REF</sub>" shall be understood as V<sub>REF</sub>(DC), as defined in Figure 1.

This clarifies, that dc-variations of V<sub>REF</sub> affect the absolute voltage a signal has to reach to achieve a valid high or low level and therefore the time to which setup and hold is measured. System timing and voltage budgets need to account for V<sub>REF</sub>(DC) deviations from the optimum position within the data-eye of the input signals.

This also clarifies that the DRAM setup/hold specification and derating values need to include time and voltage associated with V<sub>REF</sub> ac-noise. Timing and voltage effects due to ac-noise on V<sub>REF</sub> up to the specified limit (+/-1% of V<sub>DD</sub>) are included in DRAM timings and their associated deratings.

### 10.3 AC and DC Logic Input Levels for Differential Signals

#### 10.3.1 Differential Signals Definition

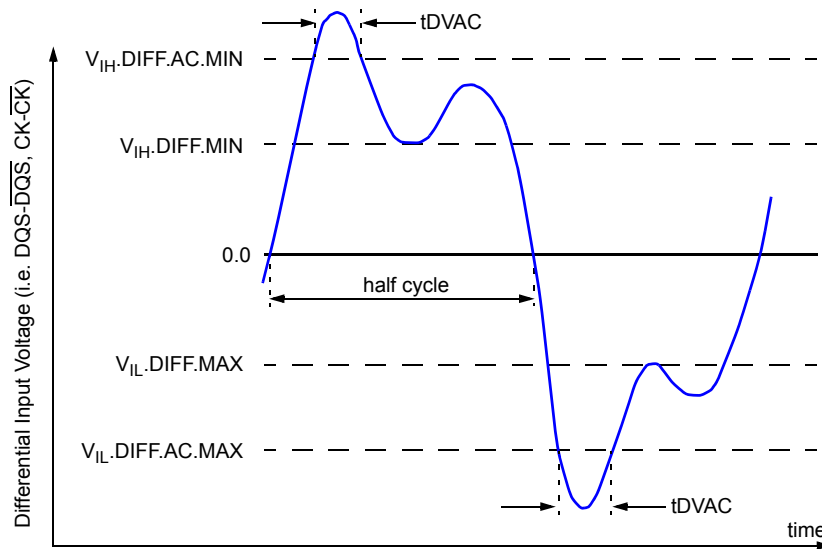

Figure 2. Definition of differential ac-swing and "time above ac level" tDVAC

#### 10.3.2 Differential Swing Requirement for Clock (CK-CK) and Strobe (DQS-DQS)

Symbol	Parameter	DDR3-800/1066/1333/1600/1866		unit	NOTE
		min	max		
$V_{IHdiff}$	differential input high	+0.2	NOTE 3	V	1
$V_{ILdiff}$	differential input low	NOTE 3	-0.2	V	1
$V_{IHdiff(AC)}$	differential input high ac	$2 \times (V_{IH(AC)} - V_{REF})$	NOTE 3	V	2
$V_{ILdiff(AC)}$	differential input low ac	NOTE 3	$2 \times (V_{IL(AC)} - V_{REF})$	V	2

- NOTE :**
- Used to define a differential signal slew-rate.
  - for CK - CK use  $V_{IH}/V_{IL(AC)}$  of ADD/CMD and  $V_{REFCA}$ ; for DQS - DQS use  $V_{IH}/V_{IL(AC)}$  of DQs and  $V_{REFDQ}$ ; if a reduced ac-high or ac-low level is used for a signal group, then the reduced level applies also here.
  - These values are not defined, however they single-ended signals CK, CK, DQS, DQS need to be within the respective limits ( $V_{IH(DC)}$  max,  $V_{IL(DC)}$  min) for single-ended signals as well as the limitations for overshoot and undershoot. Refer to "overshoot and Undershoot Specification"

[ Table 3 ] Allowed time before ringback (tDVAC) for CK - CK and DQS - DQS.

Slew Rate [V/ns]	tDVAC [ps] @ $ V_{IH/Ldiff(AC)}  = 350mV$		tDVAC [ps] @ $ V_{IH/Ldiff(AC)}  = 300mV$		tDVAC [ps] @ $ V_{IH/Ldiff(AC)}  = 270mV$		tDVAC [ps] @ $ V_{IH/Ldiff(AC)}  = 250mV$	
	min	max	min	max	min	max	min	max
> 4.0	75	-	175	-	TBD	-	TBD	-
4.0	57	-	170	-	TBD	-	TBD	-
3.0	50	-	167	-	TBD	-	TBD	-
2.0	38	-	163	-	TBD	-	TBD	-
1.8	34	-	162	-	TBD	-	TBD	-
1.6	29	-	161	-	TBD	-	TBD	-
1.4	22	-	159	-	TBD	-	TBD	-
1.2	13	-	155	-	TBD	-	TBD	-
1.0	0	-	150	-	TBD	-	TBD	-
< 1.0	0	-	150	-	TBD	-	TBD	-

10.3.3 Single-ended Requirements for Differential Signals

Each individual component of a differential signal (CK, DQS,  $\overline{CK}$ ,  $\overline{DQS}$ ) has also to comply with certain requirements for single-ended signals. CK and  $\overline{CK}$  have to approximately reach  $V_{SEHmin} / V_{SELmax}$  (approximately equal to the ac-levels ( $V_{IH(AC)} / V_{IL(AC)}$ ) for ADD/CMD signals) in every half-cycle. DQS,  $\overline{DQS}$  have to reach  $V_{SEHmin} / V_{SELmax}$  (approximately the ac-levels ( $V_{IH(AC)} / V_{IL(AC)}$ ) for DQ signals) in every half-cycle proceeding and following a valid transition. Note that the applicable ac-levels for ADD/CMD and DQ's might be different per speed-bin etc. E.g. if  $V_{IH150(AC)}/V_{IL150(AC)}$  is used for ADD/CMD signals, then these ac-levels apply also for the single-ended signals CK and  $\overline{CK}$ .

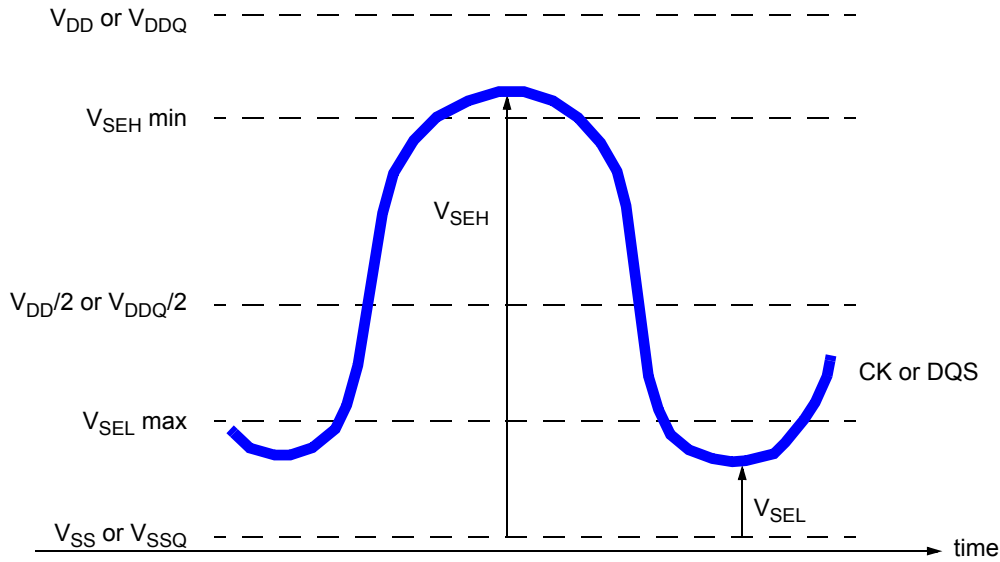

Figure 3. Single-ended requirement for differential signals

Note that while ADD/CMD and DQ signal requirements are with respect to  $V_{REF}$ , the single-ended components of differential signals have a requirement with respect to  $V_{DD}/2$ ; this is nominally the same. The transition of single-ended signals through the ac-levels is used to measure setup time. For single-ended components of differential signals the requirement to reach  $V_{SELmax}$ ,  $V_{SEHmin}$  has no bearing on timing, but adds a restriction on the common mode characteristics of these signals.

[ Table 4 ] Single-ended levels for CK, DQS,  $\overline{CK}$ ,  $\overline{DQS}$

Symbol	Parameter	DDR3-800/1066/1333/1600/1866		Unit	NOTE
		Min	Max		
$V_{SEH}$	Single-ended high-level for strobes	$(V_{DD}/2)+0.175$	NOTE3	V	1, 2
	Single-ended high-level for CK, $\overline{CK}$	$(V_{DD}/2)+0.175$	NOTE3	V	1, 2
$V_{SEL}$	Single-ended low-level for strobes	NOTE3	$(V_{DD}/2)-0.175$	V	1, 2
	Single-ended low-level for CK, $\overline{CK}$	NOTE3	$(V_{DD}/2)-0.175$	V	1, 2

- NOTE :**
- For CK,  $\overline{CK}$  use  $V_{IH}/V_{IL(AC)}$  of ADD/CMD; for strobes (DQS,  $\overline{DQS}$ ) use  $V_{IH}/V_{IL(AC)}$  of DQs.
  - $V_{IH(AC)}/V_{IL(AC)}$  for DQs is based on  $V_{REFDQ}$ ;  $V_{IH(AC)}/V_{IL(AC)}$  for ADD/CMD is based on  $V_{REFCA}$ ; if a reduced ac-high or ac-low level is used for a signal group, then the reduced level applies also here
  - These values are not defined, however the single-ended signals CK,  $\overline{CK}$ , DQS,  $\overline{DQS}$  need to be within the respective limits ( $V_{IH(DC)}$  max,  $V_{IL(DC)}$  min) for single-ended signals as well as the limitations for overshoot and undershoot. Refer to "Overshoot and Undershoot Specification"

### 10.3.4 Differential Input Cross Point Voltage

To guarantee tight setup and hold times as well as output skew parameters with respect to clock and strobe, each cross point voltage of differential input signals (CK,  $\overline{\text{CK}}$  and DQS,  $\overline{\text{DQS}}$ ) must meet the requirements in below table. The differential input cross point voltage  $V_{IX}$  is measured from the actual cross point of true and complement signal to the mid level between of  $V_{DD}$  and  $V_{SS}$ .

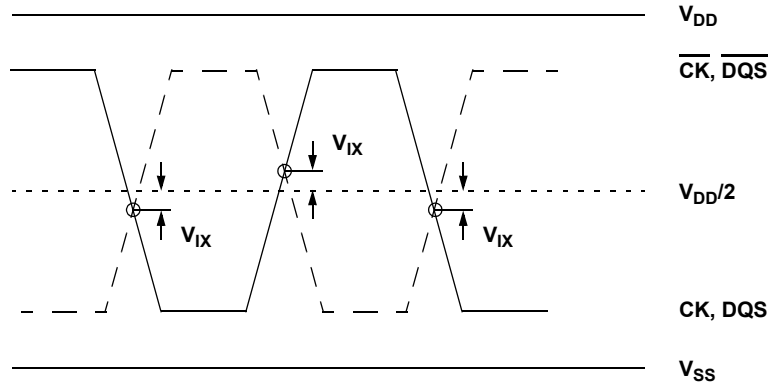

Figure 4.  $V_{IX}$  Definition

[ Table 5 ] Cross point voltage for differential input signals (CK, DQS)

Symbol	Parameter	DDR3-800/1066/1333/1600/1866		Unit	NOTE
		Min	Max		
$V_{IX}$	Differential Input Cross Point Voltage relative to $V_{DD}/2$ for CK, $\overline{\text{CK}}$	-150	150	mV	2
		-175	175	mV	1
$V_{IX}$	Differential Input Cross Point Voltage relative to $V_{DD}/2$ for DQS, $\overline{\text{DQS}}$	-150	150	mV	2

**NOTE :**  
 1. Extended range for  $V_{IX}$  is only allowed for clock and if single-ended clock input signals CK and  $\overline{\text{CK}}$  are monotonic, have a single-ended swing  $V_{SEL} / V_{SEH}$  of at least  $V_{DD}/2 \pm 250$  mV, and the differential slew rate of CK- $\overline{\text{CK}}$  is larger than 3 V/ ns.  
 2. The relation between  $V_{IX}$  Min/Max and  $V_{SEL}/V_{SEH}$  should satisfy following.  
 $(V_{DD}/2) + V_{IX}(\text{Min}) - V_{SEL} \geq 25\text{mV}$   
 $V_{SEH} - ((V_{DD}/2) + V_{IX}(\text{Max})) \geq 25\text{mV}$

### 10.4 Slew Rate Definition for Single Ended Input Signals

See "Address / Command Setup, Hold and Derating" for single-ended slew rate definitions for address and command signals.  
 See "Data Setup, Hold and Slew Rate Derating" for single-ended slew rate definitions for data signals.

### 10.5 Slew rate definition for Differential Input Signals

Input slew rate for differential signals (CK,  $\overline{\text{CK}}$  and DQS,  $\overline{\text{DQS}}$ ) are defined and measured as shown in below.

[ Table 6 ] Differential input slew rate definition

Description	Measured		Defined by
	From	To	
Differential input slew rate for rising edge (CK- $\overline{\text{CK}}$ and DQS- $\overline{\text{DQS}}$ )	$V_{ILdiffmax}$	$V_{IHdiffmin}$	$\frac{V_{IHdiffmin} - V_{ILdiffmax}}{\text{Delta TRdiff}}$
Differential input slew rate for falling edge (CK- $\overline{\text{CK}}$ and DQS- $\overline{\text{DQS}}$ )	$V_{IHdiffmin}$	$V_{ILdiffmax}$	$\frac{V_{IHdiffmin} - V_{ILdiffmax}}{\text{Delta TFdiff}}$

**NOTE :** The differential signal (i.e. CK -  $\overline{\text{CK}}$  and DQS -  $\overline{\text{DQS}}$ ) must be linear between these thresholds

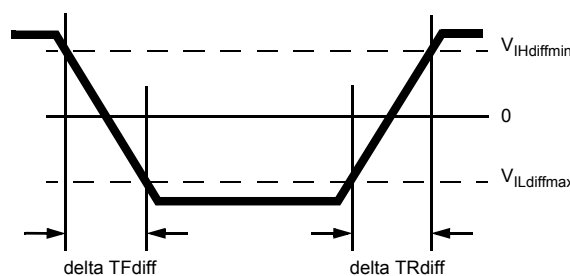

Figure 5. Differential input slew rate definition for DQS,  $\overline{\text{DQS}}$  and CK,  $\overline{\text{CK}}$

## 11. AC & DC Output Measurement Levels

### 11.1 Single Ended AC and DC Output Levels

[ Table 7 ] Single Ended AC and DC output levels

Symbol	Parameter	DDR3-800/1066/1333/1600/1866	Units	NOTE
V <sub>OH(DC)</sub>	DC output high measurement level (for IV curve linearity)	0.8 x V <sub>DDQ</sub>	V	
V <sub>OM(DC)</sub>	DC output mid measurement level (for IV curve linearity)	0.5 x V <sub>DDQ</sub>	V	
V <sub>OL(DC)</sub>	DC output low measurement level (for IV curve linearity)	0.2 x V <sub>DDQ</sub>	V	
V <sub>OH(AC)</sub>	AC output high measurement level (for output SR)	V <sub>TT</sub> + 0.1 x V <sub>DDQ</sub>	V	1
V <sub>OL(AC)</sub>	AC output low measurement level (for output SR)	V <sub>TT</sub> - 0.1 x V <sub>DDQ</sub>	V	1

**NOTE** : 1. The swing of +/-0.1 x V<sub>DDQ</sub> is based on approximately 50% of the static single ended output high or low swing with a driver impedance of 40Ω and an effective test load of 25Ω to V<sub>TT</sub>=V<sub>DDQ</sub>/2.

### 11.2 Differential AC and DC Output Levels

[ Table 8 ] Differential AC and DC output levels

Symbol	Parameter	DDR3-800/1066/1333/1600/1866	Units	NOTE
V <sub>OHdiff(AC)</sub>	AC differential output high measurement level (for output SR)	+0.2 x V <sub>DDQ</sub>	V	1
V <sub>OLdiff(AC)</sub>	AC differential output low measurement level (for output SR)	-0.2 x V <sub>DDQ</sub>	V	1

**NOTE** : 1. The swing of +/-0.2xV<sub>DDQ</sub> is based on approximately 50% of the static single ended output high or low swing with a driver impedance of 40Ω and an effective test load of 25Ω to V<sub>TT</sub>=V<sub>DDQ</sub>/2 at each of the differential outputs.

### 11.3 Single-ended Output Slew Rate

With the reference load for timing measurements, output slew rate for falling and rising edges is defined and measured between V<sub>OL(AC)</sub> and V<sub>OH(AC)</sub> for single ended signals as shown in below.

[ Table 9 ] Single ended Output slew rate definition

Description	Measured		Defined by
	From	To	
Single ended output slew rate for rising edge	V <sub>OL(AC)</sub>	V <sub>OH(AC)</sub>	$\frac{V_{OH(AC)} - V_{OL(AC)}}{\Delta TRse}$
Single ended output slew rate for falling edge	V <sub>OH(AC)</sub>	V <sub>OL(AC)</sub>	$\frac{V_{OH(AC)} - V_{OL(AC)}}{\Delta TFse}$

**NOTE** : Output slew rate is verified by design and characterization, and may not be subject to production test.

[ Table 10 ] Single ended output slew rate

Parameter	Symbol	DDR3-800		DDR3-1066		DDR3-1333		DDR3-1600		DDR3-1866		Units
		Min	Max	Min	Max	Min	Max	Min	Max	Min	Max	
Single ended output slew rate	SRQse	2.5	5	2.5	5	2.5	5	2.5	5	2.5	5 <sup>1)</sup>	V/ns

Description : SR : Slew Rate

Q : Query Output (like in DQ, which stands for Data-in, Query-Output)

se : Single-ended Signals

For Ron = RZQ/7 setting

**NOTE** : 1) In two cases, a maximum slew rate of 6V/ns applies for a single DQ signal within a byte lane.

- Case\_1 is defined for a single DQ signal within a byte lane which is switching into a certain direction (either from high to low or low to high) while all remaining DQ signals in the same byte lane are static (i.e they stay at either high or low).
- Case\_2 is defined for a single DQ signals in the same byte lane are switching into the opposite direction (i.e. from low to high or high to low respectively). For the remaining DQ signal switching into the opposite direction, the regular maximum limit of 5 V/ns applies.

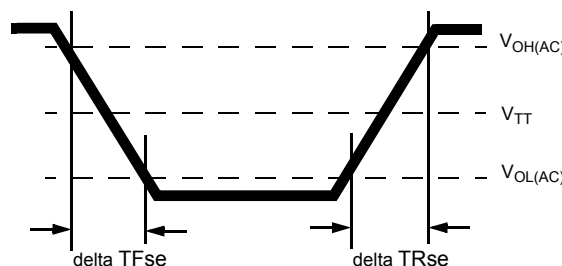

Figure 6. Single-ended Output Slew Rate Definition



### 11.4 Differential Output Slew Rate

With the reference load for timing measurements, output slew rate for falling and rising edges is defined and measured between  $V_{OLdiff}(AC)$  and  $V_{OHdiff}(AC)$  for differential signals as shown in below.

[ Table 11 ] Differential Output slew rate definition

Description	Measured		Defined by
	From	To	
Differential output slew rate for rising edge	$V_{OLdiff}(AC)$	$V_{OHdiff}(AC)$	$\frac{V_{OHdiff}(AC)-V_{OLdiff}(AC)}{\Delta TR_{diff}}$
Differential output slew rate for falling edge	$V_{OHdiff}(AC)$	$V_{OLdiff}(AC)$	$\frac{V_{OHdiff}(AC)-V_{OLdiff}(AC)}{\Delta TF_{diff}}$

**NOTE** : Output slew rate is verified by design and characterization, and may not be subject to production test.

[ Table 12 ] Differential Output slew rate

Parameter	Symbol	DDR3-800		DDR3-1066		DDR3-1333		DDR3-1600		DDR3-1866		Units
		Min	Max	Min	Max	Min	Max	Min	Max	Min	Max	
Differential output slew rate	SRQdiff	5	10	5	10	5	10	5	10	5	12	V/ns

Description : SR : Slew Rate

Q : Query Output (like in DQ, which stands for Data-in, Query-Output)

diff : Differential Signals

For Ron = RZQ/7 setting

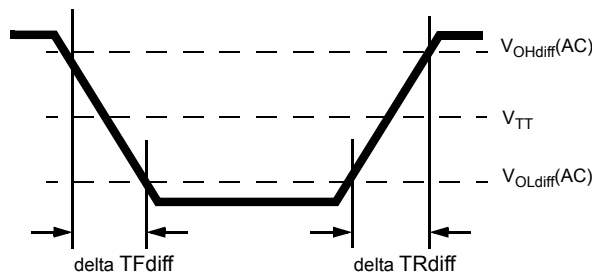

Figure 7. Differential output slew rate definition

## 12. DIMM IDD specification definition

Symbol	Description
IDD0	<b>Operating One Bank Active-Precharge Current</b> <b>CKE:</b> High; <b>External clock:</b> On; <b>tCK, nRC, nRAS, CL:</b> Refer to Component Datasheet for detail pattern ; <b>BL:</b> 8 <sup>1)</sup> ; <b>AL:</b> 0; <b>CS:</b> High between ACT and PRE; <b>Command, Address, Bank Address Inputs:</b> partially toggling ; <b>Data IO:</b> FLOATING; <b>DM:</b> stable at 0; <b>Bank Activity:</b> Cycling with one bank active at a time: 0,0,1,1,2,2,... ; <b>Output Buffer and RTT:</b> Enabled in Mode Registers <sup>2)</sup> ; <b>ODT Signal:</b> stable at 0; <b>Pattern Details:</b> Refer to Component Datasheet for detail pattern
IDD1	<b>Operating One Bank Active-Read-Precharge Current</b> <b>CKE:</b> High; <b>External clock:</b> On; <b>tCK, nRC, nRAS, nRCD, CL:</b> Refer to Component Datasheet for detail pattern ; <b>BL:</b> 8 <sup>1)</sup> ; <b>AL:</b> 0; <b>CS:</b> High between ACT, RD and PRE; <b>Command, Address, Bank Address Inputs, Data IO:</b> partially toggling ; <b>DM:</b> stable at 0; <b>Bank Activity:</b> Cycling with one bank active at a time: 0,0,1,1,2,2,... ; <b>Output Buffer and RTT:</b> Enabled in Mode Registers <sup>2)</sup> ; <b>ODT Signal:</b> stable at 0; <b>Pattern Details:</b> Refer to Component Datasheet for detail pattern
IDD2N	<b>Precharge Standby Current</b> <b>CKE:</b> High; <b>External clock:</b> On; <b>tCK, CL:</b> Refer to Component Datasheet for detail pattern ; <b>BL:</b> 8 <sup>1)</sup> ; <b>AL:</b> 0; <b>CS:</b> stable at 1; <b>Command, Address, Bank Address Inputs:</b> partially toggling ; <b>Data IO:</b> FLOATING; <b>DM:</b> stable at 0; <b>Bank Activity:</b> all banks closed; <b>Output Buffer and RTT:</b> Enabled in Mode Registers <sup>2)</sup> ; <b>ODT Signal:</b> stable at 0; <b>Pattern Details:</b> Refer to Component Datasheet for detail pattern
IDD2P0	<b>Precharge Power-Down Current Slow Exit</b> <b>CKE:</b> Low; <b>External clock:</b> On; <b>tCK, CL:</b> Refer to Component Datasheet for detail pattern ; <b>BL:</b> 8 <sup>1)</sup> ; <b>AL:</b> 0; <b>CS:</b> stable at 1; <b>Command, Address, Bank Address Inputs:</b> stable at 0; <b>Data IO:</b> FLOATING; <b>DM:</b> stable at 0; <b>Bank Activity:</b> all banks closed; <b>Output Buffer and RTT:</b> Enabled in Mode Registers <sup>2)</sup> ; <b>ODT Signal:</b> stable at 0; <b>Precharge Power Down Mode:</b> Slow Exit <sup>3)</sup>
IDD2P1	<b>Precharge Power-Down Current Fast Exit</b> <b>CKE:</b> Low; <b>External clock:</b> On; <b>tCK, CL:</b> Refer to Component Datasheet for detail pattern ; <b>BL:</b> 8 <sup>1)</sup> ; <b>AL:</b> 0; <b>CS:</b> stable at 1; <b>Command, Address, Bank Address Inputs:</b> stable at 0; <b>Data IO:</b> FLOATING; <b>DM:</b> stable at 0; <b>Bank Activity:</b> all banks closed; <b>Output Buffer and RTT:</b> Enabled in Mode Registers <sup>2)</sup> ; <b>ODT Signal:</b> stable at 0; <b>Precharge Power Down Mode:</b> Fast Exit <sup>3)</sup>
IDD2Q	<b>Precharge Quiet Standby Current</b> <b>CKE:</b> High; <b>External clock:</b> On; <b>tCK, CL:</b> Refer to Component Datasheet for detail pattern ; <b>BL:</b> 8 <sup>1)</sup> ; <b>AL:</b> 0; <b>CS:</b> stable at 1; <b>Command, Address, Bank Address Inputs:</b> stable at 0; <b>Data IO:</b> FLOATING; <b>DM:</b> stable at 0; <b>Bank Activity:</b> all banks closed; <b>Output Buffer and RTT:</b> Enabled in Mode Registers <sup>2)</sup> ; <b>ODT Signal:</b> stable at 0
IDD3N	<b>Active Standby Current</b> <b>CKE:</b> High; <b>External clock:</b> On; <b>tCK, CL:</b> Refer to Component Datasheet for detail pattern ; <b>BL:</b> 8 <sup>1)</sup> ; <b>AL:</b> 0; <b>CS:</b> stable at 1; <b>Command, Address, Bank Address Inputs:</b> partially toggling ; <b>Data IO:</b> FLOATING; <b>DM:</b> stable at 0; <b>Bank Activity:</b> all banks open; <b>Output Buffer and RTT:</b> Enabled in Mode Registers <sup>2)</sup> ; <b>ODT Signal:</b> stable at 0; <b>Pattern Details:</b> Refer to Component Datasheet for detail pattern
IDD3P	<b>Active Power-Down Current</b> <b>CKE:</b> Low; <b>External clock:</b> On; <b>tCK, CL:</b> Refer to Component Datasheet for detail pattern ; <b>BL:</b> 8 <sup>1)</sup> ; <b>AL:</b> 0; <b>CS:</b> stable at 1; <b>Command, Address, Bank Address Inputs:</b> stable at 0; <b>Data IO:</b> FLOATING; <b>DM:</b> stable at 0; <b>Bank Activity:</b> all banks open; <b>Output Buffer and RTT:</b> Enabled in Mode Registers <sup>2)</sup> ; <b>ODT Signal:</b> stable at 0
IDD4R	<b>Operating Burst Read Current</b> <b>CKE:</b> High; <b>External clock:</b> On; <b>tCK, CL:</b> Refer to Component Datasheet for detail pattern ; <b>BL:</b> 8 <sup>1)</sup> ; <b>AL:</b> 0; <b>CS:</b> High between RD; <b>Command, Address, Bank Address Inputs:</b> partially toggling ; <b>Data IO:</b> seamless read data burst with different data between one burst and the next one ; <b>DM:</b> stable at 0; <b>Bank Activity:</b> all banks open, <b>RD commands cycling through banks:</b> 0,0,1,1,2,2,... ; <b>Output Buffer and RTT:</b> Enabled in Mode Registers <sup>2)</sup> ; <b>ODT Signal:</b> stable at 0; <b>Pattern Details:</b> Refer to Component Datasheet for detail pattern
IDD4W	<b>Operating Burst Write Current</b> <b>CKE:</b> High; <b>External clock:</b> On; <b>tCK, CL:</b> Refer to Component Datasheet for detail pattern ; <b>BL:</b> 8 <sup>1)</sup> ; <b>AL:</b> 0; <b>CS:</b> High between WR; <b>Command, Address, Bank Address Inputs:</b> partially toggling ; <b>Data IO:</b> seamless write data burst with different data between one burst and the next one ; <b>DM:</b> stable at 0; <b>Bank Activity:</b> all banks open, <b>WR commands cycling through banks:</b> 0,0,1,1,2,2,... ; <b>Output Buffer and RTT:</b> Enabled in Mode Registers <sup>2)</sup> ; <b>ODT Signal:</b> stable at HIGH; <b>Pattern Details:</b> Refer to Component Datasheet for detail pattern
IDD5B	<b>Burst Refresh Current</b> <b>CKE:</b> High; <b>External clock:</b> On; <b>tCK, CL, nRFC:</b> Refer to Component Datasheet for detail pattern ; <b>BL:</b> 8 <sup>1)</sup> ; <b>AL:</b> 0; <b>CS:</b> High between REF; <b>Command, Address, Bank Address Inputs:</b> partially toggling ; <b>Data IO:</b> FLOATING; <b>DM:</b> stable at 0; <b>Bank Activity:</b> REF command every nRFC ; <b>Output Buffer and RTT:</b> Enabled in Mode Registers <sup>2)</sup> ; <b>ODT Signal:</b> stable at 0; <b>Pattern Details:</b> Refer to Component Datasheet for detail pattern
IDD6	<b>Self Refresh Current: Normal Temperature Range</b> <b>TCASE:</b> 0 - 85°C; <b>Auto Self-Refresh (ASR):</b> Disabled <sup>4)</sup> ; <b>Self-Refresh Temperature Range (SRT):</b> Normal <sup>5)</sup> ; <b>CKE:</b> Low; <b>External clock:</b> Off; <b>CK and CK:</b> LOW; <b>CL:</b> Refer to Component Datasheet for detail pattern ; <b>BL:</b> 8 <sup>1)</sup> ; <b>AL:</b> 0; <b>CS, Command, Address, Bank Address, Data IO:</b> FLOATING; <b>DM:</b> stable at 0; <b>Bank Activity:</b> Self-Refresh operation; <b>Output Buffer and RTT:</b> Enabled in Mode Registers <sup>2)</sup> ; <b>ODT Signal:</b> FLOATING
IDD6ET	<b>Self-Refresh Current: Extended Temperature Range (optional)<sup>6)</sup></b> <b>TCASE:</b> 0 - 95°C; <b>Auto Self-Refresh (ASR):</b> Disabled <sup>4)</sup> ; <b>Self-Refresh Temperature Range (SRT):</b> Extended <sup>5)</sup> ; <b>CKE:</b> Low; <b>External clock:</b> Off; <b>CK and CK:</b> LOW; <b>CL:</b> Refer to Component Datasheet for detail pattern ; <b>BL:</b> 8 <sup>1)</sup> ; <b>AL:</b> 0; <b>CS, Command, Address, Bank Address, Data IO:</b> FLOATING; <b>DM:</b> stable at 0; <b>Bank Activity:</b> Extended Temperature Self-Refresh operation; <b>Output Buffer and RTT:</b> Enabled in Mode Registers <sup>2)</sup> ; <b>ODT Signal:</b> FLOATING
IDD7	<b>Operating Bank Interleave Read Current</b> <b>CKE:</b> High; <b>External clock:</b> On; <b>tCK, nRC, nRAS, nRCD, nRRD, nFAW, CL:</b> Refer to Component Datasheet for detail pattern ; <b>BL:</b> 8 <sup>1)</sup> ; <b>AL:</b> CL-1; <b>CS:</b> High between ACT and RDA; <b>Command, Address, Bank Address Inputs:</b> partially toggling ; <b>Data IO:</b> read data bursts with different data between one burst and the next one ; <b>DM:</b> stable at 0; <b>Bank Activity:</b> two times interleaved cycling through banks (0, 1, ...7) with different addressing ; <b>Output Buffer and RTT:</b> Enabled in Mode Registers <sup>2)</sup> ; <b>ODT Signal:</b> stable at 0; <b>Pattern Details:</b> Refer to Component Datasheet for detail pattern
IDD8	<b>RESET Low Current</b> <b>RESET :</b> Low; <b>External clock :</b> off; <b>CK and CK :</b> LOW; <b>CKE :</b> FLOATING ; <b>CS, Command, Address, Bank Address, Data IO :</b> FLOATING ; <b>ODT Signal :</b> FLOATING

**NOTE :**

- 1) Burst Length: BL8 fixed by MRS: set MR0 A[1,0]=00B
- 2) Output Buffer Enable: set MR1 A[12] = 0B; set MR1 A[5,1] = 01B; RTT\_Nom enable: set MR1 A[9,6,2] = 011B; RTT\_Wr enable: set MR2 A[10,9] = 10B
- 3) Precharge Power Down Mode: set MR0 A12=0B for Slow Exit or MR0 A12=1B for Fast Exit
- 4) Auto Self-Refresh (ASR): set MR2 A6 = 0B to disable or 1B to enable feature
- 5) Self-Refresh Temperature Range (SRT): set MR2 A7=0B for normal or 1B for extended temperature range
- 6) Refer to DRAM supplier data sheet and/or DIMM SPD to determine if optional features or requirements are supported by DDR3 SDRAM device
- 7) IDD current measure method and detail patterns are described on DDR3 component datasheet
- 8) VDD and VDDQ are merged on module PCB.
- 9) DIMM IDD SPEC is measured with Qoff condition  
(IDDQ values are not considered)

## 13. IDD SPEC Table

### M471B5773DH0 : 2GB (256Mx64) Module

Symbol	CF8 (DDR3-1066@CL=7)	CH9 (DDR3-1333@CL=9)	CK0 (DDR3-1600@CL=11)	CMA (DDR3-1866@CL=13)	Unit	NOTE
IDD0	280	320	360	400	mA	1
IDD1	360	400	440	480	mA	1
IDD2P0(slow exit)	96	96	96	96	mA	
IDD2P1(fast exit)	120	120	120	136	mA	
IDD2N	136	160	160	160	mA	
IDD2Q	136	160	160	160	mA	
IDD3P	136	136	160	160	mA	
IDD3N	240	280	280	296	mA	
IDD4R	520	600	720	800	mA	1
IDD4W	560	640	760	880	mA	1
IDD5B	880	920	960	960	mA	1
IDD6	96	96	96	96	mA	
IDD7	840	1080	1120	1160	mA	1
IDD8	96	96	96	96	mA	

**NOTE :**

1. DIMM IDD SPEC is calculated with considering de-actived rank(IDLE) is IDD2N.

### M471B5273DH0 : 4GB (512Mx64) Module

Symbol	CF8 (DDR3-1066@CL=7)	CH9 (DDR3-1333@CL=9)	CK0 (DDR3-1600@CL=11)	CMA (DDR3-1866@CL=13)	Unit	NOTE
IDD0	416	480	520	560	mA	1
IDD1	496	560	600	640	mA	1
IDD2P0(slow exit)	192	192	192	192	mA	
IDD2P1(fast exit)	240	240	240	272	mA	
IDD2N	272	320	320	320	mA	
IDD2Q	272	320	320	320	mA	
IDD3P	272	272	320	320	mA	
IDD3N	376	440	440	456	mA	
IDD4R	656	760	880	960	mA	1
IDD4W	696	800	920	1040	mA	1
IDD5B	1016	1080	1120	1120	mA	1
IDD6	192	192	192	192	mA	
IDD7	976	1240	1280	1320	mA	1
IDD8	192	192	192	192	mA	

**NOTE :**

1. DIMM IDD SPEC is calculated with considering de-actived rank(IDLE) is IDD2N.

## 14. Input/Output Capacitance

[ Table 13 ] Input/Output Capacitance

Parameter	Symbol	DDR3-800		DDR3-1066		DDR3-1333		DDR3-1600		DDR3-1866		Units	NOTE
		Min	Max	Min	Max	Min	Max	Min	Max	Min	Max		
Input/output capacitance (DQ, DM, DQS, $\overline{DQS}$ , TDQS, $\overline{TDQS}$ )	CIO	1.5	3.0	1.5	2.7	1.5	2.5	1.5	2.3	1.4	2.2	pF	1,2,3
Input capacitance (CK and $\overline{CK}$ )	CCK	0.8	1.6	0.8	1.6	0.8	1.4	0.8	1.4	0.8	1.3	pF	2,3
Input capacitance delta (CK and $\overline{CK}$ )	CDCK	0	0.15	0	0.15	0	0.15	0	0.15	0	0.15	pF	2,3,4
Input capacitance (All other input-only pins)	CI	0.75	1.5	0.75	1.5	0.75	1.3	0.75	1.3	0.75	1.2	pF	2,3,6
Input capacitance delta (DQS and $\overline{DQS}$ )	CDDQS	0	0.2	0	0.2	0	0.15	0	0.15	0	0.15	pF	2,3,5
Input capacitance delta (All control input-only pins)	CDI_CTRL	-0.5	0.3	-0.5	0.3	-0.4	0.2	-0.4	0.2	-0.4	0.2	pF	2,3,7,8
Input capacitance delta (all ADD and CMD input-only pins)	CDI_ADD_CMD	-0.5	0.5	-0.5	0.5	-0.4	0.4	-0.4	0.4	-0.4	0.4	pF	2,3,9,10
Input/output capacitance delta (DQ, DM, DQS, $\overline{DQS}$ , TDQS, $\overline{TDQS}$ )	CDIO	-0.5	0.3	-0.5	0.3	-0.5	0.3	-0.5	0.3	-0.5	0.3	pF	2,3,11
Input/output capacitance of ZQ pin	CZQ	-	3	-	3	-	3	-	3	-	3	pF	2, 3, 12

**NOTE : This parameter is Component Input/Output Capacitance so that is different from Module level Capacitance.**

1. Although the DM, TDQS and  $\overline{TDQS}$  pins have different functions, the loading matches DQ and DQS

2. This parameter is not subject to production test. It is verified by design and characterization.

The capacitance is measured according to JEP147 ("PROCEDURE FOR MEASURING INPUT CAPACITANCE USING A VECTOR NETWORK ANALYZER (VNA)") with  $V_{DD}$ ,  $V_{DDQ}$ ,  $V_{SS}$ ,  $V_{SSQ}$  applied and all other pins floating (except the pin under test, CKE,  $\overline{RESET}$  and ODT as necessary).  $V_{DD}=V_{DDQ}=1.5V$ ,  $V_{BIAS}=V_{DD}/2$  and on-die termination off.

3. This parameter applies to monolithic devices only; stacked/dual-die devices are not covered here

4. Absolute value of  $CCK-\overline{CCK}$

5. Absolute value of  $CIO(DQS)-CIO(\overline{DQS})$

6. CI applies to ODT,  $\overline{CS}$ , CKE, A0-A15, BA0-BA2,  $\overline{RAS}$ ,  $\overline{CAS}$ ,  $\overline{WE}$ .

7. CDI\_CTRL applies to ODT,  $\overline{CS}$  and CKE

8.  $CDI\_CTRL=CI(CTRL)-0.5*(CI(CLK)+CI(\overline{CLK}))$

9. CDI\_ADD\_CMD applies to A0-A15, BA0-BA2,  $\overline{RAS}$ ,  $\overline{CAS}$  and  $\overline{WE}$

10.  $CDI\_ADD\_CMD=CI(ADD\_CMD) - 0.5*(CI(CLK)+CI(\overline{CLK}))$

11.  $CDIO=CIO(DQ,DM) - 0.5*(CIO(DQS)+CIO(\overline{DQS}))$

12. Maximum external load capacitance on ZQ pin: 5pF

## 15. Electrical Characteristics and AC timing

(0 °C < T<sub>CASE</sub> ≤ 95 °C, V<sub>DDQ</sub> = 1.5V ± 0.075V; V<sub>DD</sub> = 1.5V ± 0.075V)

### 15.1 Refresh Parameters by Device Density

Parameter	Symbol	1Gb	2Gb	4Gb	8Gb	Units	NOTE	
All Bank Refresh to active/refresh cmd time	tRFC	110	160	300	350	ns		
Average periodic refresh interval	tREFI	0 °C ≤ T <sub>CASE</sub> ≤ 85°C	7.8	7.8	7.8	7.8	μs	
		85 °C < T <sub>CASE</sub> ≤ 95°C	3.9	3.9	3.9	3.9	μs	1

**NOTE :**  
1. Users should refer to the DRAM supplier data sheet and/or the DIMM SPD to determine if DDR3 SDRAM devices support the following options or requirements referred to in this material.

### 15.2 Speed Bins and CL, tRCD, tRP, tRC and tRAS for Corresponding Bin

Speed	DDR3-800	DDR3-1066	DDR3-1333	DDR3-1600	DDR3-1866	Units	NOTE
Bin (CL - tRCD - tRP)	6-6-6	7-7-7	9-9-9	11-11-11	13-13-13		
Parameter	min	min	min	min	min		
CL	6	7	9	11	13	tCK	
tRCD	15	13.13	13.5	13.75	13.91	ns	
tRP	15	13.13	13.5	13.75	13.91	ns	
tRAS	37.5	37.5	36	35	34	ns	
tRC	52.5	50.63	49.5	48.75	47.91	ns	
tRRD	10	7.5	6.0	6.0	5.0	ns	
tFAW	40	37.5	30	30	27	ns	

### 15.3 Speed Bins and CL, tRCD, tRP, tRC and tRAS for corresponding Bin

DDR3 SDRAM Speed Bins include tCK, tRCD, tRP, tRAS and tRC for each corresponding bin.

[ Table 14 ] DDR3-800 Speed Bins

Speed		DDR3-800		Units	NOTE
CL-nRCD-nRP		6 - 6 - 6			
Parameter	Symbol	min	max		
Internal read command to first data	tAA	15	20	ns	
ACT to internal read or write delay time	tRCD	15	-	ns	
PRE command period	tRP	15	-	ns	
ACT to ACT or REF command period	tRC	52.5	-	ns	
ACT to PRE command period	tRAS	37.5	9*tREFI	ns	
CL = 5	CWL = 5	tCK(AVG)	3.0	3.3	1,2,3,4,10,11
CL = 6	CWL = 5	tCK(AVG)	2.5	3.3	1,2,3
Supported CL Settings			5, 6	nCK	
Supported CWL Settings			5	nCK	

[ Table 15 ] DDR3-1066 Speed Bins

Speed		DDR3-1066		Units	NOTE	
CL-nRCD-nRP		7 - 7 - 7				
Parameter	Symbol	min	max			
Internal read command to first data		tAA	13.125	20	ns	
ACT to internal read or write delay time		tRCD	13.125	-	ns	
PRE command period		tRP	13.125	-	ns	
ACT to ACT or REF command period		tRC	50.625	-	ns	
ACT to PRE command period		tRAS	37.5	9*tREFI	ns	
CL = 5	CWL = 5	tCK(AVG)	3.0	3.3	ns	1,2,3,4,5,10,11
	CWL = 6	tCK(AVG)	Reserved		ns	4
CL = 6	CWL = 5	tCK(AVG)	2.5	3.3	ns	1,2,3,5
	CWL = 6	tCK(AVG)	Reserved		ns	1,2,3,4
CL = 7	CWL = 5	tCK(AVG)	Reserved		ns	4
	CWL = 6	tCK(AVG)	1.875	<2.5	ns	1,2,3,4,9
CL = 8	CWL = 5	tCK(AVG)	Reserved		ns	4
	CWL = 6	tCK(AVG)	1.875	<2.5	ns	1,2,3
Supported CL Settings		5, 6,7,8		nCK		
Supported CWL Settings		5,6		nCK		

[ Table 16 ] DDR3-1333 Speed Bins

Speed		DDR3-1333		Units	NOTE	
CL-nRCD-nRP		9 -9 - 9				
Parameter	Symbol	min	max			
Internal read command to first data	tAA	13.5 (13.125) <sup>9</sup>	20	ns		
ACT to internal read or write delay time	tRCD	13.5 (13.125) <sup>9</sup>	-	ns		
PRE command period	tRP	13.5 (13.125) <sup>9</sup>	-	ns		
ACT to ACT or REF command period	tRC	49.5 (49.125) <sup>9</sup>	-	ns		
ACT to PRE command period	tRAS	36	9*tREFI	ns		
CL = 5	CWL = 5	tCK(AVG)	3.0	3.3	ns	1,2,3,4,6,10,11
	CWL = 6,7	tCK(AVG)	Reserved		ns	4
CL = 6	CWL = 5	tCK(AVG)	2.5	3.3	ns	1,2,3,6
	CWL = 6	tCK(AVG)	Reserved		ns	1,2,3,4,6
	CWL = 7	tCK(AVG)	Reserved		ns	4
CL = 7	CWL = 5	tCK(AVG)	Reserved		ns	4
	CWL = 6	tCK(AVG)	1.875	<2.5	ns	1,2,3,4,6
	CWL = 7	tCK(AVG)	Reserved		ns	1,2,3,4
CL = 8	CWL = 5	tCK(AVG)	Reserved		ns	4
	CWL = 6	tCK(AVG)	1.875	<2.5	ns	1,2,3,6
	CWL = 7	tCK(AVG)	Reserved		ns	1,2,3,4
CL = 9	CWL = 5,6	tCK(AVG)	Reserved		ns	4
	CWL = 7	tCK(AVG)	1.5	<1.875	ns	1,2,3,4,9
CL = 10	CWL = 5,6	tCK(AVG)	Reserved		ns	4
	CWL = 7	tCK(AVG)	Reserved		ns	1,2,3
Supported CL Settings		5,6,7,8,9		nCK		
Supported CWL Settings		5,6,7		nCK		



[ Table 17 ] DDR3-1600 Speed Bins

Speed		DDR3-1600		Units	NOTE	
CL-nRCD-nRP		11-11-11				
Parameter	Symbol	min	max			
Internal read command to first data	tAA	13.75 (13.125) <sup>9</sup>	20	ns		
ACT to internal read or write delay time	tRCD	13.75 (13.125) <sup>9</sup>	-	ns		
PRE command period	tRP	13.75 (13.125) <sup>9</sup>	-	ns		
ACT to ACT or REF command period	tRC	48.75 (48.125) <sup>9</sup>	-	ns		
ACT to PRE command period	tRAS	35	9*tREFI	ns		
CL = 5	CWL = 5	tCK(AVG)	3.0	3.3	ns	1,2,3,4,7,10,11
	CWL = 6,7,8	tCK(AVG)	Reserved		ns	4
CL = 6	CWL = 5	tCK(AVG)	2.5	3.3	ns	1,2,3,7
	CWL = 6	tCK(AVG)	Reserved		ns	1,2,3,4,7
	CWL = 7, 8	tCK(AVG)	Reserved		ns	4
CL = 7	CWL = 5	tCK(AVG)	Reserved		ns	4
	CWL = 6	tCK(AVG)	1.875	<2.5	ns	1,2,3,4,7
	CWL = 7	tCK(AVG)	Reserved		ns	1,2,3,4,7
	CWL = 8	tCK(AVG)	Reserved		ns	4
CL = 8	CWL = 5	tCK(AVG)	Reserved		ns	4
	CWL = 6	tCK(AVG)	1.875	<2.5	ns	1,2,3,7
	CWL = 7	tCK(AVG)	Reserved		ns	1,2,3,4,7
	CWL = 8	tCK(AVG)	Reserved		ns	1,2,3,4
CL = 9	CWL = 5,6	tCK(AVG)	Reserved		ns	4
	CWL = 7	tCK(AVG)	1.5	<1.875	ns	1,2,3,4,7
	CWL = 8	tCK(AVG)	Reserved		ns	1,2,3,4
CL = 10	CWL = 5,6	tCK(AVG)	Reserved		ns	4
	CWL = 7	tCK(AVG)	1.5	<1.875	ns	1,2,3,7
	CWL = 8	tCK(AVG)	Reserved		ns	1,2,3,4
CL = 11	CWL = 5,6,7	tCK(AVG)	Reserved		ns	4
	CWL = 8	tCK(AVG)	1.25	<1.5	ns	1,2,3,9
Supported CL Settings		5,6,7,8,9,10,11		nCK		
Supported CWL Settings		5,6,7,8		nCK		

[ Table 18 ] DDR3-1866 Speed Bins

Speed		DDR3-1866		Units	NOTE	
CL-nRCD-nRP		13-13-13				
Parameter	Symbol	min	max			
Internal read command to first data	tAA	13.91 (13.125) <sup>12</sup>	20	ns		
ACT to internal read or write delay time	tRCD	13.91 (13.125) <sup>12</sup>	-	ns		
PRE command period	tRP	13.91 (13.125) <sup>12</sup>	-	ns		
ACT to ACT or REF command period	tRC	47.91 (47.125) <sup>12</sup>	-	ns		
ACT to PRE command period	tRAS	34	9*tREFI	ns		
CL = 5	CWL = 5	tCK(AVG)	3.0	3.3	ns	1,2,3,4,8,10,11
	CWL = 6,7,8,9	tCK(AVG)	Reserved		ns	4
CL = 6	CWL = 5	tCK(AVG)	2.5	3.3	ns	1,2,3,8
	CWL = 6	tCK(AVG)	Reserved		ns	1,2,3,4,8
	CWL = 7,8,9	tCK(AVG)	Reserved		ns	4
CL = 7	CWL = 5	tCK(AVG)	Reserved		ns	4
	CWL = 6	tCK(AVG)	1.875	2.5	ns	1,2,3,4,8
	CWL = 7,8,9	tCK(AVG)	Reserved		ns	4
CL = 8	CWL = 5	tCK(AVG)	Reserved		ns	4
	CWL = 6	tCK(AVG)	1.875	<2.5	ns	1,2,3,8
	CWL = 7	tCK(AVG)	Reserved		ns	1,2,3,4,8
	CWL = 8,9	tCK(AVG)	Reserved		ns	4
CL = 9	CWL = 5,6	tCK(AVG)	Reserved		ns	4
	CWL = 7	tCK(AVG)	1.5	1.875	ns	1,2,3,4,8
	CWL = 8	tCK(AVG)	Reserved		ns	4
	CWL = 9	tCK(AVG)	Reserved		ns	4
CL = 10	CWL = 5,6	tCK(AVG)	Reserved		ns	4
	CWL = 7	tCK(AVG)	1.5	<1.875	ns	1,2,3,8
	CWL = 8	tCK(AVG)	Reserved		ns	1,2,3,4,8
CL = 11	CWL = 5,6,7	tCK(AVG)	Reserved		ns	4
	CWL = 8	tCK(AVG)	1.25	1.5	ns	1,2,3,4,8
	CWL = 9	tCK(AVG)	Reserved		ns	1,2,3,4
CL = 12	CWL = 5,6,7,8	tCK(AVG)	Reserved		ns	4
	CWL = 9	tCK(AVG)	Reserved		ns	1,2,3,4
CL = 13	CWL = 5,6,7,8	tCK(AVG)	Reserved		ns	4
	CWL = 9	tCK(AVG)	1.07	<1.25	ns	1,2,3,9
Supported CL Settings		5,6,7,8,9,10,11,13		nCK		
Supported CWL Settings		5,6,7,8,9		nCK		

### 15.3.1 Speed Bin Table Notes

Absolute Specification ( $T_{OPER}$ ;  $V_{DDQ} = V_{DD} = 1.5V \pm 0.075V$ );

**NOTE :**

- The CL setting and CWL setting result in tCK(AVG).MIN and tCK(AVG).MAX requirements. When making a selection of tCK(AVG), both need to be fulfilled: Requirements from CL setting as well as requirements from CWL setting.
- tCK(AVG).MIN limits: Since CAS Latency is not purely analog - data and strobe output are synchronized by the DLL - all possible intermediate frequencies may not be guaranteed. An application should use the next smaller JEDEC standard tCK(AVG) value (2.5, 1.875, 1.5, or 1.25 ns) when calculating  $CL [nCK] = tAA [ns] / tCK(AVG) [ns]$ , rounding up to the next "SupportedCL".
- tCK(AVG).MAX limits: Calculate  $tCK(AVG) = tAA.MAX / CL$  SELECTED and round the resulting tCK(AVG) down to the next valid speed bin (i.e. 3.3ns or 2.5ns or 1.875 ns or 1.25 ns). This result is tCK(AVG).MAX corresponding to CL SELECTED.
- "Reserved" settings are not allowed. User must program a different value.
- Any DDR3-1066 speed bin also supports functional operation at lower frequencies as shown in the table which are not subject to Production Tests but verified by Design/Characterization.
- Any DDR3-1333 speed bin also supports functional operation at lower frequencies as shown in the table which are not subject to Production Tests but verified by Design/Characterization.
- Any DDR3-1600 speed bin also supports functional operation at lower frequencies as shown in the table which are not subject to Production Tests but verified by Design/Characterization.
- Any DDR3-1866 speed bin also supports functional operation at lower frequencies as shown in the table which are not subject to Production Tests but verified by Design/Characterization.
- For devices supporting optional downshift to CL=7 and CL=9, tAA/tRCD/tRP min must be 13.125 ns or lower. SPD settings must be programmed to match. For example, DDR3-1333(CL9) devices supporting downshift to DDR3-1066(CL7) should program 13.125 ns in SPD bytes for tAAmin (Byte 16), tRCDmin (Byte 18), and tRPmin (Byte 20). DDR3-1600(CL11) devices supporting downshift to DDR3-1333(CL9) or DDR3-1066(CL7) should program 13.125 ns in SPD bytes for tAAmin (Byte16), tRCDmin (Byte 18), and tRPmin (Byte 20). DDR3-1866(CL13) devices supporting downshift to DDR3-1600(CL11) or DDR3-1333(CL9) or DDR3-1066(CL7) should program 13.125 ns in SPD bytes for tAAmin (Byte16), tRCDmin (Byte 18), and tRPmin (Byte 20). DDR3-1600 devices supporting down binning to DDR3-1333 or DDR3-1066 should program 13.125ns in SPD byte for tAAmin (Byte 16), tRCDmin (Byte 18) and tRPmin (Byte 20). Once tRP (Byte 20) is programmed to 13.125ns, tRCmin (Byte 21,23) also should be programmed accordingly. For example, 49.125ns, (tRASmin + tRPmin = 36ns + 13.125ns) for DDR3-1333 and 48.125ns (tRASmin + tRPmin = 35ns + 13.125ns) for DDR3-1600.
- DDR3 800 AC timing apply if DRAM operates at lower than 800 MT/s data rate.
- For CL5 support DIMM SPD include CL5 on supportable CAS Latency(Byte 14-bit1 set HIGH).
- For devices supporting optional down binning to CL=11, CL=9 and CL=7, tAA/tRCD/tRPmin must be 13.125ns. SPD setting must be programmed to match. For example, DDR3-1866 devices supporting down binning to DDR3-1600 or DDR3-1333 or 1066 should program 13.125ns in SPD bytes for tAAmin(byte16), tRCDmin(Byte18) and tRPmin (byte20). Once tRP (Byte20) is programmed to 13.125ns, tRCmin (Byte21,23) also should be programmed accordingly. For example, 47.125ns (tRASmin + tRPmin = 34ns + 13.125ns)

## 16. Timing Parameters by Speed Grade

[ Table 19 ] Timing Parameters by Speed Bins for DDR3-800 to DDR3-1333

Speed		DDR3-800		DDR3-1066		DDR3-1333		Units	NOTE
Parameter	Symbol	MIN	MAX	MIN	MAX	MIN	MAX		
<b>Clock Timing</b>									
Minimum Clock Cycle Time (DLL off mode)	tCK(DLL_OFF)	8	-	8	-	8	-	ns	6
Average Clock Period	tCK(avg)	See Speed Bins Table						ps	
Clock Period	tCK(abs)	tCK(avg)min + tJIT(per)min	tCK(avg)max + tJIT(per)max	tCK(avg)min + tJIT(per)min	tCK(avg)max + tJIT(per)max	tCK(avg)min + tJIT(per)min	tCK(avg)max + tJIT(per)max	ps	
Average high pulse width	tCH(avg)	0.47	0.53	0.47	0.53	0.47	0.53	tCK(avg)	
Average low pulse width	tCL(avg)	0.47	0.53	0.47	0.53	0.47	0.53	tCK(avg)	
Clock Period Jitter	tJIT(per)	-100	100	-90	90	-80	80	ps	
Clock Period Jitter during DLL locking period	tJIT(per, lck)	-90	90	-80	80	-70	70	ps	
Cycle to Cycle Period Jitter	tJIT(cc)	200		180		160		ps	
Cycle to Cycle Period Jitter during DLL locking period	tJIT(cc, lck)	180		160		140		ps	
Cumulative error across 2 cycles	tERR(2per)	- 147	147	- 132	132	- 118	118	ps	
Cumulative error across 3 cycles	tERR(3per)	- 175	175	- 157	157	- 140	140	ps	
Cumulative error across 4 cycles	tERR(4per)	- 194	194	- 175	175	- 155	155	ps	
Cumulative error across 5 cycles	tERR(5per)	- 209	209	- 188	188	- 168	168	ps	
Cumulative error across 6 cycles	tERR(6per)	- 222	222	- 200	200	- 177	177	ps	
Cumulative error across 7 cycles	tERR(7per)	- 232	232	- 209	209	- 186	186	ps	
Cumulative error across 8 cycles	tERR(8per)	- 241	241	- 217	217	- 193	193	ps	
Cumulative error across 9 cycles	tERR(9per)	- 249	249	- 224	224	- 200	200	ps	
Cumulative error across 10 cycles	tERR(10per)	- 257	257	- 231	231	- 205	205	ps	
Cumulative error across 11 cycles	tERR(11per)	- 263	263	- 237	237	- 210	210	ps	
Cumulative error across 12 cycles	tERR(12per)	- 269	269	- 242	242	- 215	215	ps	
Cumulative error across n = 13, 14 ... 49, 50 cycles	tERR(nper)	tERR(nper)min = (1 + 0.68ln(n))*tJIT(per)min tERR(nper)max = (1 - 0.68ln(n))*tJIT(per)max						ps	24
Absolute clock HIGH pulse width	tCH(abs)	0.43	-	0.43	-	0.43	-	tCK(avg)	25
Absolute clock Low pulse width	tCL(abs)	0.43	-	0.43	-	0.43	-	tCK(avg)	26
<b>Data Timing</b>									
DQS, $\overline{DQS}$ to DQ skew, per group, per access	tDQSQ	-	200	-	150	-	125	ps	13
DQ output hold time from DQS, $\overline{DQS}$	tQH	0.38	-	0.38	-	0.38	-	tCK(avg)	13, g
DQ low-impedance time from CK, $\overline{CK}$	tLZ(DQ)	-800	400	-600	300	-500	250	ps	13,14, f
DQ high-impedance time from CK, $\overline{CK}$	tHZ(DQ)	-	400	-	300	-	250	ps	13,14, f
Data setup time to DQS, $\overline{DQS}$ referenced to $V_{IH}(AC)V_{IL}(AC)$ levels	tDS(base) AC175	75	-	25	-	-	-	ps	d, 17
	tDS(base) AC150	125	-	75	-	30	-	ps	d, 17
Data hold time to DQS, $\overline{DQS}$ referenced to $V_{IH}(AC)V_{IL}(AC)$ levels	tDH(base) DC100	150	-	100	-	65	-	ps	d, 17
DQ and DM Input pulse width for each input	tDIPW	600	-	490	-	400	-	ps	28
<b>Data Strobe Timing</b>									
DQS, $\overline{DQS}$ differential READ Preamble	tRPRE	0.9	NOTE 19	0.9	NOTE 19	0.9	NOTE 19	tCK	13, 19, g
DQS, $\overline{DQS}$ differential READ Postamble	tRPST	0.3	NOTE 11	0.3	NOTE 11	0.3	NOTE 11	tCK	11, 13, b
DQS, $\overline{DQS}$ differential output high time	tQSH	0.38	-	0.38	-	0.4	-	tCK(avg)	13, g
DQS, $\overline{DQS}$ differential output low time	tQSL	0.38	-	0.38	-	0.4	-	tCK(avg)	13, g
DQS, $\overline{DQS}$ differential WRITE Preamble	tWPRE	0.9	-	0.9	-	0.9	-	tCK	
DQS, $\overline{DQS}$ differential WRITE Postamble	tWPST	0.3	-	0.3	-	0.3	-	tCK	
DQS, $\overline{DQS}$ rising edge output access time from rising CK, $\overline{CK}$	tDQSCK	-400	400	-300	300	-255	255	ps	13,f
DQS, $\overline{DQS}$ low-impedance time (Referenced from RL-1)	tLZ(DQS)	-800	400	-600	300	-500	250	ps	13,14,f
DQS, $\overline{DQS}$ high-impedance time (Referenced from RL+BL/2)	tHZ(DQS)	-	400	-	300	-	250	ps	12,13,14
DQS, $\overline{DQS}$ differential input low pulse width	tDQSL	0.45	0.55	0.45	0.55	0.45	0.55	tCK	29, 31
DQS, $\overline{DQS}$ differential input high pulse width	tDQSH	0.45	0.55	0.45	0.55	0.45	0.55	tCK	30, 31
DQS, $\overline{DQS}$ rising edge to CK, $\overline{CK}$ rising edge	tDQSS	-0.25	0.25	-0.25	0.25	-0.25	0.25	tCK(avg)	c
DQS, $\overline{DQS}$ falling edge setup time to CK, $\overline{CK}$ rising edge	tDSS	0.2	-	0.2	-	0.2	-	tCK(avg)	c, 32
DQS, $\overline{DQS}$ falling edge hold time to CK, $\overline{CK}$ rising edge	tDSH	0.2	-	0.2	-	0.2	-	tCK(avg)	c, 32

[ Table 19 ] Timing Parameters by Speed Bins for DDR3-800 to DDR3-1333 (Cont.)

Speed		DDR3-800		DDR3-1066		DDR3-1333		Units	NOTE
Parameter	Symbol	MIN	MAX	MIN	MAX	MIN	MAX		
<b>Command and Address Timing</b>									
DLL locking time	tDLLK	512	-	512	-	512	-	nCK	
internal READ Command to PRECHARGE Command delay	tRTP	max (4nCK,7.5ns)	-	max (4nCK,7.5ns)	-	max (4nCK,7.5ns)	-		e
Delay from start of internal write transaction to internal read command	tWTR	max (4nCK,7.5ns)	-	max (4nCK,7.5ns)	-	max (4nCK,7.5ns)	-		e,18
WRITE recovery time	tWR	15	-	15	-	15	-	ns	e
Mode Register Set command cycle time	tMRD	4	-	4	-	4	-	nCK	
Mode Register Set command update delay	tMOD	max (12nCK,15ns)	-	max (12nCK,15ns)	-	max (12nCK,15ns)	-		
CAS# to CAS# command delay	tCCD	4	-	4	-	4	-	nCK	
Auto precharge write recovery + precharge time	tDAL(min)	WR + roundup (tRP / tCK(AVG))						nCK	
Multi-Purpose Register Recovery Time	tMPRR	1	-	1	-	1	-	nCK	22
ACTIVE to PRECHARGE command period	tRAS	See "Speed Bins and CL, tRCD, tRP, tRC and tRAS for corresponding Bin" on page 42						ns	e
ACTIVE to ACTIVE command period for 1KB page size	tRRD	max (4nCK,10ns)	-	max (4nCK,7.5ns)	-	max (4nCK,6ns)	-		e
ACTIVE to ACTIVE command period for 2KB page size	tRRD	max (4nCK,10ns)	-	max (4nCK,10ns)	-	max (4nCK,7.5ns)	-		e
Four activate window for 1KB page size	tFAW	40	-	37.5	-	30	-	ns	e
Four activate window for 2KB page size	tFAW	50	-	50	-	45	-	ns	e
Command and Address setup time to CK, $\overline{\text{CK}}$ referenced to $V_{IH}(AC) / V_{IL}(AC)$ levels	tIS(base) AC175	200	-	125	-	65	-	ps	b,16
	tIS(base) AC150	200+150	-	125+150	-	65+125	-	ps	b,16,27
Command and Address hold time from CK, $\overline{\text{CK}}$ referenced to $V_{IH}(AC) / V_{IL}(AC)$ levels	tIH(base) DC100	275	-	200	-	140	-	ps	b,16
Control & Address Input pulse width for each input	tIPW	900	-	780	-	620	-	ps	28
<b>Calibration Timing</b>									
Power-up and RESET calibration time	tZQinitl	512	-	512	-	512	-	nCK	
Normal operation Full calibration time	tZQoper	256	-	256	-	256	-	nCK	
Normal operation short calibration time	tZQCS	64	-	64	-	64	-	nCK	23
<b>Reset Timing</b>									
Exit Reset from CKE HIGH to a valid command	tXPR	max(5nCK, tRFC + 10ns)	-	max(5nCK, tRFC + 10ns)	-	max(5nCK, tRFC + 10ns)	-		
<b>Self Refresh Timing</b>									
Exit Self Refresh to commands not requiring a locked DLL	tXS	max(5nCK,tRFC C + 10ns)	-	max(5nCK,tRFC C + 10ns)	-	max(5nCK,tRFC C + 10ns)	-		
Exit Self Refresh to commands requiring a locked DLL	tXSDLL	tDLLK(min)	-	tDLLK(min)	-	tDLLK(min)	-	nCK	
Minimum CKE low width for Self refresh entry to exit timing	tCKESR	tCKE(min) + 1tCK	-	tCKE(min) + 1tCK	-	tCKE(min) + 1tCK	-		
Valid Clock Requirement after Self Refresh Entry (SRE) or Power-Down Entry (PDE)	tCKSRE	max(5nCK, 10ns)	-	max(5nCK, 10ns)	-	max(5nCK, 10ns)	-		
Valid Clock Requirement before Self Refresh Exit (SRX) or Power-Down Exit (PDX) or Reset Exit	tCKSRX	max(5nCK, 10ns)	-	max(5nCK, 10ns)	-	max(5nCK, 10ns)	-		

[ Table 19 ] Timing Parameters by Speed Bins for DDR3-800 to DDR3-1333 (Cont.)

Speed		DDR3-800		DDR3-1066		DDR3-1333		Units	NOTE
Parameter	Symbol	MIN	MAX	MIN	MAX	MIN	MAX		
<b>Power Down Timing</b>									
Exit Power Down with DLL on to any valid command; Exit Pre-charge Power Down with DLL frozen to commands not requiring a locked DLL	tXP	max (3nCK, 7.5ns)	-	max (3nCK, 7.5ns)	-	max (3nCK, 6ns)	-		
Exit Precharge Power Down with DLL frozen to commands requiring a locked DLL	tXPDLL	max (10nCK, 24ns)	-	max (10nCK, 24ns)	-	max (10nCK, 24ns)	-		2
CKE minimum pulse width	tCKE	max (3nCK, 7.5ns)	-	max (3nCK, 5.625ns)	-	max (3nCK, 5.625ns)	-		
Command pass disable delay	tCPDED	1	-	1	-	1	-	nCK	
Power Down Entry to Exit Timing	tPD	tCKE(min)	9*tREFI	tCKE(min)	9*tREFI	tCKE(min)	9*tREFI	tCK	15
Timing of ACT command to Power Down entry	tACTPDEN	1	-	1	-	1	-	nCK	20
Timing of PRE command to Power Down entry	tPRPDEN	1	-	1	-	1	-	nCK	20
Timing of RD/RDA command to Power Down entry	tRDPDEN	RL + 4 + 1	-	RL + 4 + 1	-	RL + 4 + 1	-		
Timing of WR command to Power Down entry (BL8OTF, BL8MRS, BC4OTF)	tWRPDEN	WL + 4 + (tWR/ tCK(avg))	-	WL + 4 + (tWR/ tCK(avg))	-	WL + 4 + (tWR/ tCK(avg))	-	nCK	9
Timing of WRA command to Power Down entry (BL8OTF, BL8MRS, BC4OTF)	tWRAPDEN	WL+4+WR + 1	-	WL+4+WR+1	-	WL+4+WR+1	-	nCK	10
Timing of WR command to Power Down entry (BC4MRS)	tWRPDEN	WL + 2 + (tWR/ tCK(avg))	-	WL + 2 + (tWR/ tCK(avg))	-	WL + 2 + (tWR/ tCK(avg))	-	nCK	9
Timing of WRA command to Power Down entry (BC4MRS)	tWRAPDEN	WL + 2 + WR + 1	-	WL + 2 + WR + 1	-	WL + 2 + WR + 1	-	nCK	10
Timing of REF command to Power Down entry	tREFPDEN	1	-	1	-	1	-		20,21
Timing of MRS command to Power Down entry	tMRSPDEN	tMOD(min)	-	tMOD(min)	-	tMOD(min)	-		
<b>ODT Timing</b>									
ODT high time without write command or with write command and BC4	ODTH4	4	-	4	-	4	-	nCK	
ODT high time with Write command and BL8	ODTH8	6	-	6	-	6	-	nCK	
Asynchronous RTT turn-on delay (Power-Down with DLL frozen)	tAONPD	2	8.5	2	8.5	2	8.5	ns	
Asynchronous RTT turn-off delay (Power-Down with DLL frozen)	tAOFPD	2	8.5	2	8.5	2	8.5	ns	
RTT turn-on	tAON	-400	400	-300	300	-250	250	ps	7,f
RTT_NOM and RTT_WR turn-off time from ODTLoff reference	tAOF	0.3	0.7	0.3	0.7	0.3	0.7	tCK(avg)	8,f
RTT dynamic change skew	tADC	0.3	0.7	0.3	0.7	0.3	0.7	tCK(avg)	f
<b>Write Leveling Timing</b>									
First DQS pulse rising edge after tDQSS margining mode is programmed	tWLMRD	40	-	40	-	40	-	tCK	3
DQS/DQS delay after tDQS margining mode is programmed	tWLDQSEN	25	-	25	-	25	-	tCK	3
Write leveling setup time from rising CK, $\overline{CK}$ crossing to rising DQS, $\overline{DQS}$ crossing	tWLS	325	-	245	-	195	-	ps	
Write leveling hold time from rising DQS, $\overline{DQS}$ crossing to rising CK, $\overline{CK}$ crossing	tWLH	325	-	245	-	195	-	ps	
Write leveling output delay	tWLO	0	9	0	9	0	9	ns	
Write leveling output error	tWLOE	0	2	0	2	0	2	ns	

[ Table 20 ] Timing Parameters by Speed Bins for DDR3-1600, DDR3-1866

Speed		DDR3-1600		DDR3-1866		Units	NOTE
Parameter	Symbol	MIN	MAX	MIN	MAX		
<b>Clock Timing</b>							
Minimum Clock Cycle Time (DLL off mode)	tCK(DLL_OFF)	8	-	8	-	ns	6
Average Clock Period	tCK(avg)	See Speed Bins Table				ps	
Clock Period	tCK(abs)	tCK(avg)min + tJIT(per)min	tCK(avg)max + tJIT(per)max	tCK(avg)min + tJIT(per)min	tCK(avg)max + tJIT(per)max	ps	
Average high pulse width	tCH(avg)	0.47	0.53	0.47	0.53	tCK(avg)	
Average low pulse width	tCL(avg)	0.47	0.53	0.47	0.53	tCK(avg)	
Clock Period Jitter	tJIT(per)	-70	70	-60	60	ps	
Clock Period Jitter during DLL locking period	tJIT(per, lck)	-60	60	-50	50	ps	
Cycle to Cycle Period Jitter	tJIT(cc)	140		120		ps	
Cycle to Cycle Period Jitter during DLL locking period	tJIT(cc, lck)	120		100		ps	
Cumulative error across 2 cycles	tERR(2per)	-103	103	-88	88	ps	
Cumulative error across 3 cycles	tERR(3per)	-122	122	-105	105	ps	
Cumulative error across 4 cycles	tERR(4per)	-136	136	-117	117	ps	
Cumulative error across 5 cycles	tERR(5per)	-147	147	-126	126	ps	
Cumulative error across 6 cycles	tERR(6per)	-155	155	-133	133	ps	
Cumulative error across 7 cycles	tERR(7per)	-163	163	-139	139	ps	
Cumulative error across 8 cycles	tERR(8per)	-169	169	-145	145	ps	
Cumulative error across 9 cycles	tERR(9per)	-175	175	-150	150	ps	
Cumulative error across 10 cycles	tERR(10per)	-180	180	-154	154	ps	
Cumulative error across 11 cycles	tERR(11per)	-184	184	-158	158	ps	
Cumulative error across 12 cycles	tERR(12per)	-188	188	-161	161	ps	
Cumulative error across n = 13, 14 ... 49, 50 cycles	tERR(nper)	tERR(nper)min = (1 + 0.68ln(n))*tJIT(per)min tERR(nper)max = (1 + 0.68ln(n))*tJIT(per)max				ps	24
Absolute clock HIGH pulse width	tCH(abs)	0.43	-	0.43	-	tCK(avg)	25
Absolute clock Low pulse width	tCL(abs)	0.43	-	0.43	-	tCK(avg)	26
<b>Data Timing</b>							
DQS, $\overline{DQS}$ to DQ skew, per group, per access	tDQSQ	-	100	-	85	ps	13
DQ output hold time from DQS, $\overline{DQS}$	tQH	0.38	-	0.38	-	tCK(avg)	13, g
DQ low-impedance time from CK, $\overline{CK}$	tLZ(DQ)	-450	225	-390	195	ps	13,14, f
DQ high-impedance time from CK, $\overline{CK}$	tHZ(DQ)	-	225	-	195	ps	13,14, f
Data setup time to DQS, $\overline{DQS}$ referenced to $V_{IH}(AC)V_{IL}(AC)$ levels	tDS(base) AC150	-	-	TBD	-	ps	d, 17
	tDS(base) AC125	10	-	TBD	-	ps	d, 17
Data hold time to DQS, $\overline{DQS}$ referenced to $V_{IH}(AC)V_{IL}(AC)$ levels	tDH(base) DC100	45	-	TBD	-	ps	d, 17
DQ and DM Input pulse width for each input	tDIPW	360	-	320	-	ps	28
<b>Data Strobe Timing</b>							
DQS, $\overline{DQS}$ differential READ Preamble	tRPRE	0.9	NOTE 19	0.9	NOTE 19	tCK	13, 19, g
DQS, $\overline{DQS}$ differential READ Postamble	tRPST	0.3	NOTE 11	0.3	NOTE 11	tCK	11, 13, b
DQS, $\overline{DQS}$ differential output high time	tQSH	0.4	-	0.4	-	tCK(avg)	13, g
DQS, $\overline{DQS}$ differential output low time	tQSL	0.4	-	0.4	-	tCK(avg)	13, g
DQS, $\overline{DQS}$ differential WRITE Preamble	tWPRE	0.9	-	0.9	-	tCK	
DQS, $\overline{DQS}$ differential WRITE Postamble	tWPST	0.3	-	0.3	-	tCK	
DQS, $\overline{DQS}$ rising edge output access time from rising CK, $\overline{CK}$	tDQSCK	-225	225	-195	195	ps	13,f
DQS, $\overline{DQS}$ low-impedance time (Referenced from RL-1)	tLZ(DQS)	-450	225	-390	195	ps	13,14,f
DQS, $\overline{DQS}$ high-impedance time (Referenced from RL+BL/2)	tHZ(DQS)	-	225	-	195	ps	12,13,14
DQS, $\overline{DQS}$ differential input low pulse width	tDQSL	0.45	0.55	0.45	0.55	tCK	29, 31
DQS, $\overline{DQS}$ differential input high pulse width	tDQSH	0.45	0.55	0.45	0.55	tCK	30, 31
DQS, $\overline{DQS}$ rising edge to CK, $\overline{CK}$ rising edge	tDQSS	-0.27	0.27	-0.27	0.27	tCK(avg)	c
DQS, $\overline{DQS}$ falling edge setup time to CK, $\overline{CK}$ rising edge	tDSS	0.9	NOTE 19	0.18	-	tCK(avg)	c, 32
DQS, $\overline{DQS}$ falling edge hold time to CK, $\overline{CK}$ rising edge	tDSH	0.3	NOTE 11	0.18	-	tCK(avg)	c, 32

[ Table 20 ] Timing Parameters by Speed Bins for DDR3-1600, DDR3-1866 (Cont.)

Speed		DDR3-1600		DDR3-1866		Units	NOTE	
Parameter	Symbol	MIN	MAX	MIN	MAX			
<b>Command and Address Timing</b>								
DLL locking time	tDLLK	512	-	512	-	nCK		
internal READ Command to PRECHARGE Command delay	tRTP	max (4nCK, 7.5ns)	-	max (4nCK, 7.5ns)	-		e	
Delay from start of internal write transaction to internal read command	tWTR	max (4nCK, 7.5ns)	-	max (4nCK, 7.5ns)	-		e, 18	
WRITE recovery time	tWR	15	-	15	-	ns	e	
Mode Register Set command cycle time	tMRD	4	-	4	-	nCK		
Mode Register Set command update delay	tMOD	max (12nCK, 15ns)	-	max (12nCK, 15ns)	-			
CAS# to CAS# command delay	tCCD	4	-	4	-	nCK		
Auto precharge write recovery + precharge time	tDAL(min)			WR + roundup (tRP / tCK(AVG))		nCK		
Multi-Purpose Register Recovery Time	tMPRR	1	-	1	-	nCK	22	
ACTIVE to PRECHARGE command period	tRAS	See "Speed Bins and CL, tRCD, tRP, tRC and tRAS for corresponding Bin" on page 42					ns	e
ACTIVE to ACTIVE command period for 1KB page size	tRRD	max (4nCK, 6ns)	-	max (4nCK, 5ns)	-		e	
ACTIVE to ACTIVE command period for 2KB page size	tRRD	max (4nCK, 7.5ns)	-	max (4nCK, 6ns)	-		e	
Four activate window for 1KB page size	tFAW	30	-	27	-	ns	e	
Four activate window for 2KB page size	tFAW	40	-	35	-	ns	e	
Command and Address setup time to CK, $\overline{\text{CK}}$ referenced to $V_{IH}(\text{AC}) / V_{IL}(\text{AC})$ levels	tIS(base) AC150	45	-	TBD	-	ps	b, 16	
	tIS(base) AC125	45+125	-	TBD	-	ps	b, 16, 27	
Command and Address hold time from CK, $\overline{\text{CK}}$ referenced to $V_{IH}(\text{AC}) / V_{IL}(\text{AC})$ levels	tIH(base) DC100	120	-	TBD	-	ps	b, 16	
Control & Address Input pulse width for each input	tIPW	560	-	535	-	ps	28	
<b>Calibration Timing</b>								
Power-up and RESET calibration time	tZQinitl	512	-	max(512nCK, 640ns)	-	nCK		
Normal operation Full calibration time	tZQoper	256	-	max(256nCK, 320ns)	-	nCK		
Normal operation short calibration time	tZQCS	64	-	max(64nCK, 80ns)	-	nCK	23	
<b>Reset Timing</b>								
Exit Reset from CKE HIGH to a valid command	tXPR	max(5nCK, tRFC + 10ns)	-	max(5nCK, tRFC + 10ns)	-			
<b>Self Refresh Timing</b>								
Exit Self Refresh to commands not requiring a locked DLL	tXS	max(5nCK, tRFC + 10ns)	-	max(5nCK, tRFC + 10ns)	-			
Exit Self Refresh to commands requiring a locked DLL	tXSDLL	tDLLK(min)	-	tDLLK(min)	-	nCK		
Minimum CKE low width for Self refresh entry to exit timing	tCKESR	tCKE(min) + 1tCK	-	tCKE(min) + 1nCK	-			
Valid Clock Requirement after Self Refresh Entry (SRE) or Power-Down Entry (PDE)	tCKSRE	max(5nCK, 10ns)	-	max(5nCK, 10ns)	-			
Valid Clock Requirement before Self Refresh Exit (SRX) or Power-Down Exit (PDX) or Reset Exit	tCKSRX	max(5nCK, 10ns)	-	max(5nCK, 10ns)	-			



[ Table 20 ] Timing Parameters by Speed Bins for DDR3-1600, DDR3-1866 (Cont.)

Speed		DDR3-1600		DDR3-1866		Units	NOTE
Parameter	Symbol	MIN	MAX	MIN	MAX		
<b>Power Down Timing</b>							
Exit Power Down with DLL on to any valid command; Exit Precharge Power Down with DLL frozen to commands not requiring a locked DLL	tXP	max (3nCK,6ns)	-	max(3nCK,6ns)	-		
Exit Precharge Power Down with DLL frozen to commands requiring a locked DLL	tXPDLL	max (10nCK,24ns)	-	max(10nCK,24ns)	-		2
CKE minimum pulse width	tCKE	max (3nCK,5ns)	-	max(3nCK,5ns)	-		
Command pass disable delay	tCPDED	1	-	2	-	nCK	
Power Down Entry to Exit Timing	tPD	tCKE(min)	9*tREFI	tCKE(min)	9*tREFI	tCK	15
Timing of ACT command to Power Down entry	tACTPDEN	1	-	1	-	nCK	20
Timing of PRE command to Power Down entry	tPRPDEN	1	-	1	-	nCK	20
Timing of RD/RDA command to Power Down entry	tRDPDEN	RL + 4 + 1	-	RL + 4 + 1	-		
Timing of WR command to Power Down entry (BL8OTF, BL8MRS, BC4OTF)	tWRPDEN	WL + 4 +(tWR/ tCK(avg))	-	WL + 4 +(tWR/ tCK(avg))	-	nCK	9
Timing of WRA command to Power Down entry (BL8OTF, BL8MRS, BC4OTF)	tWRAPDEN	WL + 4 +WR +1	-	WL + 4 +WR +1	-	nCK	10
Timing of WR command to Power Down entry (BC4MRS)	tWRPDEN	WL + 2 +(tWR/ tCK(avg))	-	WL + 2 +(tWR/ tCK(avg))	-	nCK	9
Timing of WRA command to Power Down entry (BC4MRS)	tWRAPDEN	WL +2 +WR +1	-	WL +2 +WR +1	-	nCK	10
Timing of REF command to Power Down entry	tREFPDEN	1	-	1	-		20,21
Timing of MRS command to Power Down entry	tMRSPDEN	tMOD(min)	-	tMOD(min)	-		
<b>ODT Timing</b>							
ODT high time without write command or with write command and BC4	ODTH4	4	-	4	-	nCK	
ODT high time with Write command and BL8	ODTH8	6	-	6	-	nCK	
Asynchronous RTT turn-on delay (Power-Down with DLL frozen)	tAONPD	2	8.5	2	8.5	ns	
Asynchronous RTT turn-off delay (Power-Down with DLL frozen)	tAOFPD	2	8.5	2	8.5	ns	
RTT turn-on	tAON	-225	225	-195	195	ps	7,f
RTT_NOM and RTT_WR turn-off time from ODTLoff reference	tAOF	0.3	0.7	0.3	0.7	tCK(avg)	8,f
RTT dynamic change skew	tADC	0.3	0.7	0.3	0.7	tCK(avg)	f
<b>Write Leveling Timing</b>							
First DQS pulse rising edge after tDQSS margining mode is programmed	tWLMRD	40	-	40	-	tCK	3
DQS/DQS delay after tDQS margining mode is programmed	tWLDQSEN	25	-	25	-	tCK	3
Write leveling setup time from rising CK, $\overline{CK}$ crossing to rising DQS, DQS crossing	tWLS	165	-	140	-	ps	
Write leveling hold time from rising DQS, $\overline{DQS}$ crossing to rising CK, $\overline{CK}$ crossing	tWLH	165	-	140	-	ps	
Write leveling output delay	tWLO	0	7.5	0	7.5	ns	
Write leveling output error	tWLOE	0	2	0	2	ns	

## 16.1 Jitter Notes

- Specific Note a** Unit 'tCK(avg)' represents the actual tCK(avg) of the input clock under operation. Unit 'nCK' represents one clock cycle of the input clock, counting the actual clock edges.ex) tMRD = 4 [nCK] means; if one Mode Register Set command is registered at Tm, another Mode Register Set command may be registered at Tm+4, even if (Tm+4 - Tm) is 4 x tCK(avg) + tERR(4per),min.
- Specific Note b** These parameters are measured from a command/address signal (CKE,  $\overline{\text{CS}}$ ,  $\overline{\text{RAS}}$ ,  $\overline{\text{CAS}}$ ,  $\overline{\text{WE}}$ , ODT, BA0, A0, A1, etc.) transition edge to its respective clock signal (CK/ $\overline{\text{CK}}$ ) crossing. The spec values are not affected by the amount of clock jitter applied (i.e. tJIT(per), tJIT(cc), etc.), as the setup and hold are relative to the clock signal crossing that latches the command/address. That is, these parameters should be met whether clock jitter is present or not.
- Specific Note c** These parameters are measured from a data strobe signal (DQS,  $\overline{\text{DQS}}$ ) crossing to its respective clock signal (CK,  $\overline{\text{CK}}$ ) crossing. The spec values are not affected by the amount of clock jitter applied (i.e. tJIT(per), tJIT(cc), etc.), as these are relative to the clock signal crossing. That is, these parameters should be met whether clock jitter is present or not.
- Specific Note d** These parameters are measured from a data signal (DM, DQ0, DQ1, etc.) transition edge to its respective data strobe signal (DQS,  $\overline{\text{DQS}}$ ) crossing.
- Specific Note e** For these parameters, the DDR3 SDRAM device supports tPARAM [nCK] = RU{ tPARAM [ns] / tCK(avg) [ns] }, which is in clock cycles, assuming all input clock jitter specifications are satisfied. For example, the device will support tRP = RU{tRP / tCK(avg)}, which is in clock cycles, if all input clock jitter specifications are met. This means: For DDR3-800 6-6-6, of which tRP = 15ns, the device will support tRP = RU{tRP / tCK(avg)} = 6, as long as the input clock jitter specifications are met, i.e. Precharge command at Tm and Active command at Tm+6 is valid even if (Tm+6 - Tm) is less than 15ns due to input clock jitter.
- Specific Note f** When the device is operated with input clock jitter, this parameter needs to be derated by the actual tERR(mper),act of the input clock, where 2 <= m <= 12. (output deratings are relative to the SDRAM input clock.)  
 For example, if the measured jitter into a DDR3-800 SDRAM has tERR(mper),act,min = - 172 ps and tERR(mper),act,max = + 193 ps, then tDQSCK,min(derated) = tDQSCK,min - tERR(mper),act,max = - 400 ps - 193 ps = - 593 ps and tDQSCK,max(derated) = tDQSCK,max - tERR(mper),act,min = 400 ps + 172 ps = + 572 ps. Similarly, tLZ(DQ) for DDR3-800 derates to tLZ(DQ),min(derated) = - 800 ps - 193 ps = - 993 ps and tLZ(DQ),max(derated) = 400 ps + 172 ps = + 572 ps. (Caution on the min/max usage!)  
 Note that tERR(mper),act,min is the minimum measured value of tERR(nper) where 2 <= n <= 12, and tERR(mper),act,max is the maximum measured value of tERR(nper) where 2 <= n <= 12.
- Specific Note g** When the device is operated with input clock jitter, this parameter needs to be derated by the actual tJIT(per),act of the input clock. (output deratings are relative to the SDRAM input clock.) For example, if the measured jitter into a DDR3-800 SDRAM has tCK(avg),act = 2500 ps, tJIT(per),act,min = - 72 ps and tJIT(per),act,max = + 93 ps, then tRPRE,min(derated) = tRPRE,min + tJIT(per),act,min = 0.9 x tCK(avg),act + tJIT(per),act,min = 0.9 x 2500 ps - 72 ps = + 2178 ps. Similarly, tQH,min(derated) = tQH,min + tJIT(per),act,min = 0.38 x tCK(avg),act + tJIT(per),act,min = 0.38 x 2500 ps - 72 ps = + 878 ps. (Caution on the min/max usage!)

## 16.2 Timing Parameter Notes

1. Actual value dependant upon measurement level definitions which are TBD.
2. Commands requiring a locked DLL are: READ (and RAP) and synchronous ODT commands.
3. The max values are system dependent.
4. WR as programmed in mode register
5. Value must be rounded-up to next higher integer value
6. There is no maximum cycle time limit besides the need to satisfy the refresh interval, tREFI.
7. For definition of RTT turn-on time tAON see "Device Operation & Timing Diagram Datasheet"
8. For definition of RTT turn-off time tAOF see "Device Operation & Timing Diagram Datasheet".
9. tWR is defined in ns, for calculation of tWRPDEN it is necessary to round up tWR / tCK to the next integer.
10. WR in clock cycles as programmed in MR0
11. The maximum read postamble is bound by tDQSCK(min) plus tQSH(min) on the left side and tHZ(DQS)max on the right side. See "Device Operation & Timing Diagram Datasheet."
12. Output timing deratings are relative to the SDRAM input clock. When the device is operated with input clock jitter, this parameter needs to be derated by TBD
13. Value is only valid for RON34
14. Single ended signal parameter. Refer to chapter 8 and chapter 9 for definition and measurement method.
15. tREFI depends on T<sub>OPER</sub>
16. tIS(base) and tIH(base) values are for 1V/ns CMD/ADD single-ended slew rate and 2V/ns CK,  $\overline{\text{CK}}$  differential slew rate, Note for DQ and DM signals,  $V_{\text{REF}}(\text{DC}) = V_{\text{REF}}\text{DQ}(\text{DC})$ . For input only pins except  $\overline{\text{RESET}}$ ,  $V_{\text{REF}}(\text{DC}) = V_{\text{REF}}\text{CA}(\text{DC})$ . See "Address/Command Setup, Hold and Derating" on component datasheet.
17. tDS(base) and tDH(base) values are for 1V/ns DQ single-ended slew rate and 2V/ns DQS,  $\overline{\text{DQS}}$  differential slew rate. Note for DQ and DM signals,  $V_{\text{REF}}(\text{DC}) = V_{\text{REF}}\text{DQ}(\text{DC})$ . For input only pins except  $\overline{\text{RESET}}$ ,  $V_{\text{REF}}(\text{DC}) = V_{\text{REF}}\text{CA}(\text{DC})$ . See "Data Setup, Hold and Slew Rate Derating" on component datasheet.
18. Start of internal write transaction is defined as follows ;  
 For BL8 (fixed by MRS and on-the-fly) : Rising clock edge 4 clock cycles after WL.  
 For BC4 (on-the-fly) : Rising clock edge 4 clock cycles after WL  
 For BC4 (fixed by MRS) : Rising clock edge 2 clock cycles after WL
19. The maximum read preamble is bound by tLZDQS(min) on the left side and tDQSCK(max) on the right side. See "Device Operation & Timing Diagram Datasheet"
20. CKE is allowed to be registered low while operations such as row activation, precharge, autoprecharge or refresh are in progress, but power-down IDD spec will not be applied until finishing those operations.
21. Although CKE is allowed to be registered LOW after a REFRESH command once tREFPDEN(min) is satisfied, there are cases where additional time such as tXPDLL(min) is also required. See "Device Operation & Timing Diagram Datasheet".
22. Defined between end of MPR read burst and MRS which reloads MPR or disables MPR function.
23. One ZQCS command can effectively correct a minimum of 0.5 % (ZQCorrection) of RON and RTT impedance error within 64 nCK for all speed bins assuming the maximum sensitivities specified in the 'Output Driver Voltage and Temperature Sensitivity' and 'ODT Voltage and Temperature Sensitivity' tables. The appropriate interval between ZQCS commands can be determined from these tables and other application specific parameters. One method for calculating the interval between ZQCS commands, given the temperature (Tdriftrate) and voltage (Vdriftrate) drift rates that the SDRAM is subject to in the application, is illustrated. The interval could be defined by the following formula:

$$\frac{\text{ZQCorrection}}{(\text{TSens} \times \text{Tdriftrate}) + (\text{VSens} \times \text{Vdriftrate})}$$

where TSens = max(dRTTdT, dRONdTM) and VSens = max(dRTTdV, dRONdVM) define the SDRAM temperature and voltage sensitivities.

For example, if TSens = 1.5% / °C, VSens = 0.15% / mV, Tdriftrate = 1°C / sec and Vdriftrate = 15 mV / sec, then the interval between ZQCS commands is calculated as:

$$\frac{0.5}{(1.5 \times 1) + (0.15 \times 15)} = 0.133 \approx 128\text{ms}$$

24. n = from 13 cycles to 50 cycles. This row defines 38 parameters.
25. tCH(abs) is the absolute instantaneous clock high pulse width, as measured from one rising edge to the following falling edge.
26. tCL(abs) is the absolute instantaneous clock low pulse width, as measured from one falling edge to the following rising edge.
27. The tIS(base) AC150 specifications are adjusted from the tIS(base) AC175 specification by adding an additional 125 ps for DDR3-800/1066 or 100ps for DDR3-1333/1600 of derating to accommodate for the lower alternate threshold of 150mV and another 25ps to account for the earlier reference point [(175mv - 150 mV) / 1 V/ns].
28. Pulse width of a input signal is defined as the width between the first crossing of  $V_{\text{REF}}(\text{DC})$  and the consecutive crossing of  $V_{\text{REF}}(\text{DC})$
29. tDQSL describes the instantaneous differential input low pulse width on  $\text{DQS-}\overline{\text{DQS}}$ , as measured from one falling edge to the next consecutive rising edge.
30. tDQSH describes the instantaneous differential input high pulse width on  $\text{DQS-}\overline{\text{DQS}}$ , as measured from one rising edge to the next consecutive falling edge.
31. tDQSH, act + tDQSL, act = 1 tCK, act ; with tXYZ, act being the actual measured value of the respective timing parameter in the application.
32. tDSH, act + tDSS, act = 1 tCK, act ; with tXYZ, act being the actual measured value of the respective timing parameter in the application.
33. The tIS(base) AC125 specifications are adjusted from the tIS(base) AC135 specification by adding an additional 75ps for DDR3-1866 and 65ps for DDR3-2133 to accommodate for the lower alternate threshold of 125mV and another 10ps to account for the earlier reference point [(135mv - 125mV) / 1 V/ns].

## 17. Physical Dimensions :

### 17.1 256Mbx8 based 256Mx64 Module (1 Rank) - M471B5773DH0

Units : Millimeters

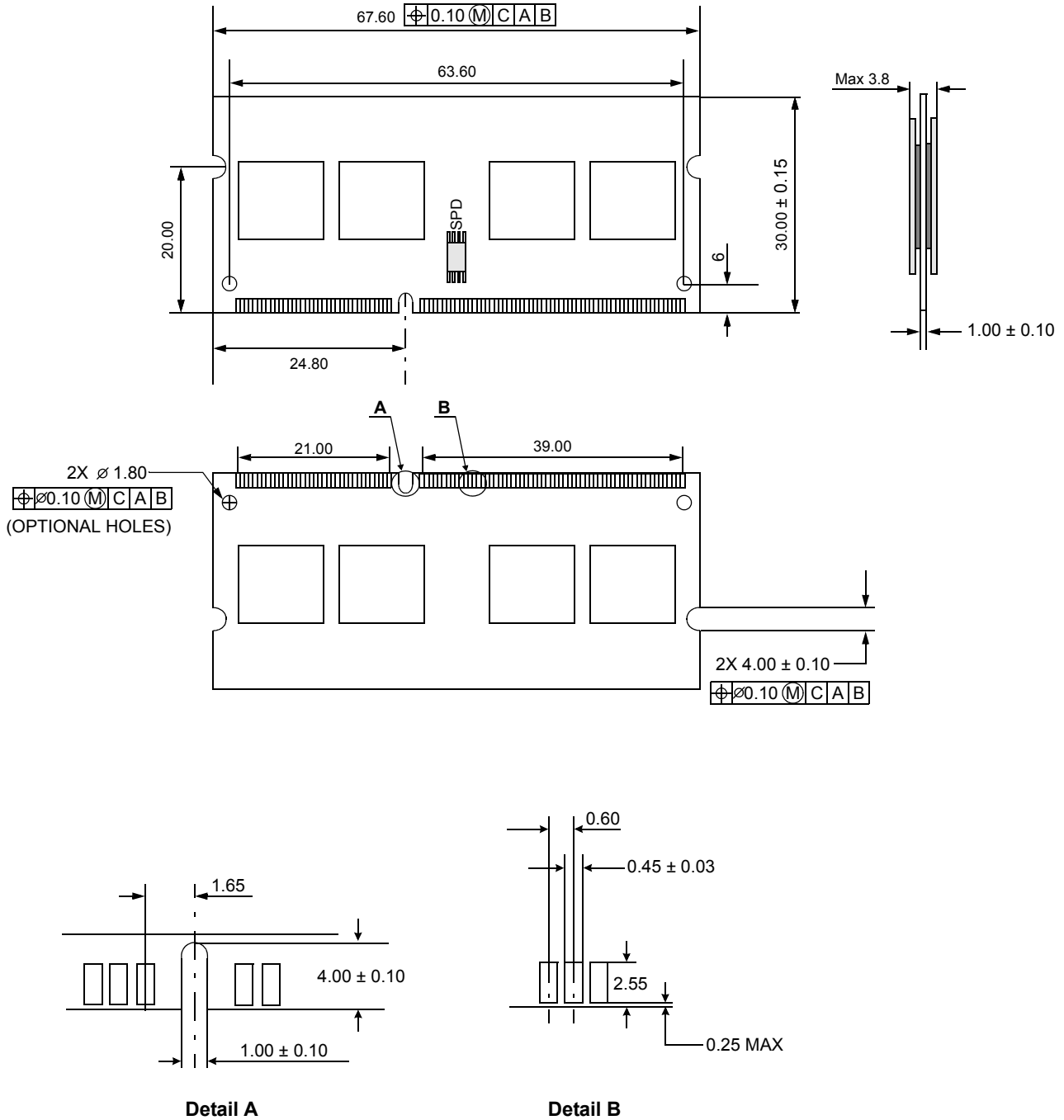

The used device is 256M x8 DDR3 SDRAM, FBGA.  
 DDR3 SDRAM Part NO : K4B2G0846D - HC\*\*

\* NOTE : Tolerances on all dimensions ±0.15 unless otherwise specified.

17.2 256Mbx8 based 512Mx64 Module (2 Ranks) - M471B5273DH0

Units : Millimeters

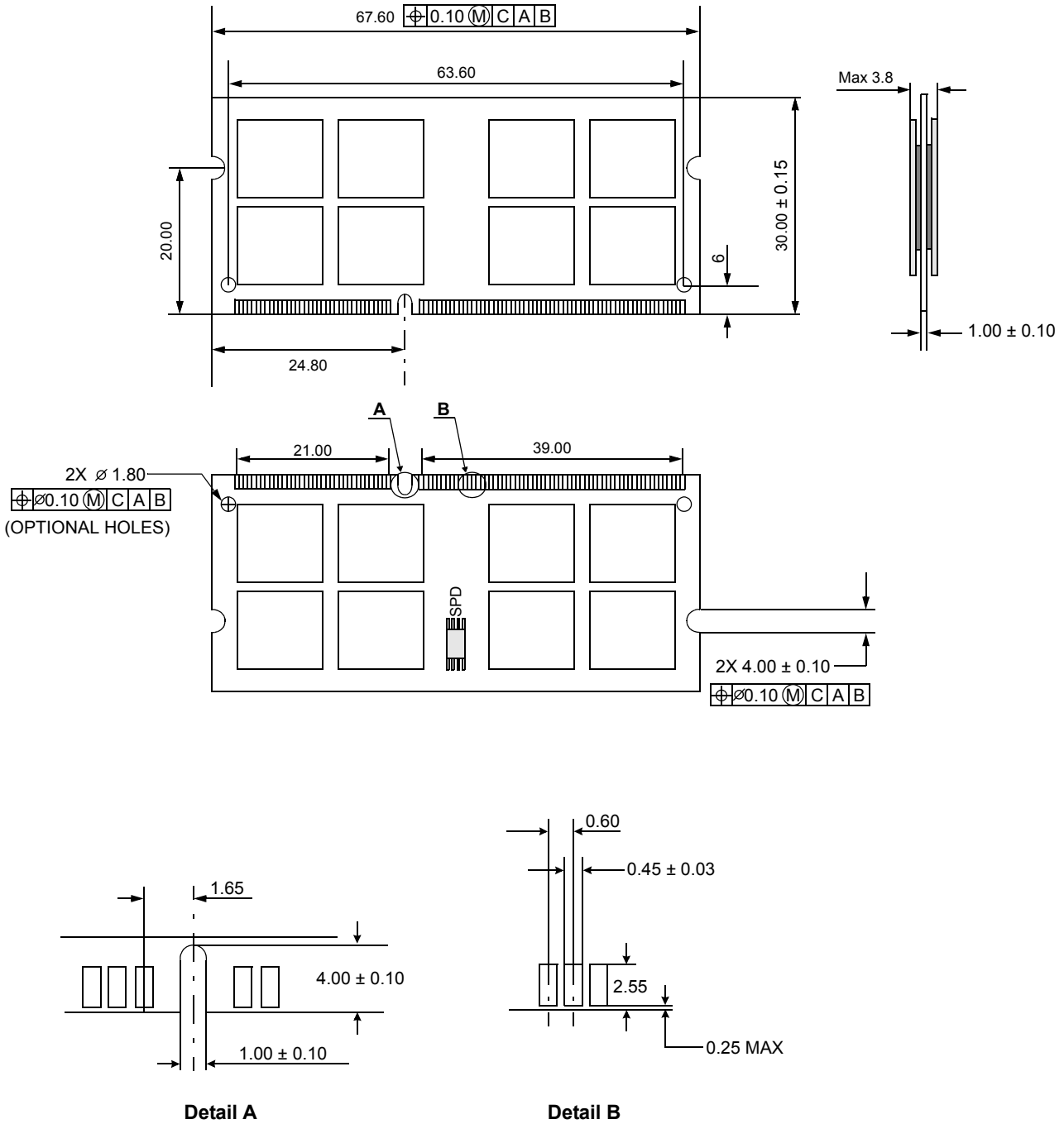

The used device is 256M x8 DDR3 SDRAM, FBGA.  
 DDR3 SDRAM Part NO : K4B2G0846D - HC\*\*

\* NOTE : Tolerances on all dimensions  $\pm 0.15$  unless otherwise specified.