

General Description

The AAT2554 is a fully integrated 500mA battery charger, a 250mA step-down converter, and a 300mA low dropout (LDO) linear regulator. The input voltage range is 4V to 6.5V for the battery charger and 2.7V to 5.5V for the step-down converter and linear regulator, making it ideal for applications operating with single-cell lithium-ion/polymer batteries.

The battery charger is a complete constant current/constant voltage linear charger. It offers an integrated pass device, reverse blocking protection, high accuracy current and voltage regulation, charge status, and charge termination. The charging current is programmable via external resistor from 15mA to 500mA. In addition to these standard features, the device offers over-voltage, current limit, and thermal protection.

The step-down converter is a highly integrated converter operating at a 1.5MHz switching frequency, minimizing the size of external components while keeping switching losses low. It has independent input and enable pins. The output voltage ranges from 0.6V to the input voltage.

The AAT2554 linear regulator is designed for fast transient response and good power supply ripple rejection. Designed for 300mA of load current, it includes short-circuit protection and thermal shutdown.

The AAT2554 is available in a Pb-free, thermally-enhanced TDFN34-16 package and is rated over the -40°C to +85°C temperature range.

Features

- Battery Charger:
 - Input Voltage Range: 4V to 6.5V
 - Programmable Charging Current up to 500mA
 - Highly Integrated Battery Charger
 - Charging Device
 - Reverse Blocking Diode
- Step-Down Converter:
 - Input Voltage Range: 2.7V to 5.5V
 - Output Voltage Range: 0.6V to V_{IN}
 - 250mA Output Current
 - Up to 96% Efficiency
 - 30 μ A Quiescent Current
 - 1.5MHz Switching Frequency
 - 100 μ s Start-Up Time
- Linear Regulator:
 - 300mA Output Current
 - Low Dropout: 400mV at 300mA
 - Fast Line and Load Transient Response
 - High Accuracy: $\pm 1.5\%$
 - 70 μ A Quiescent Current
- Short-Circuit, Over-Temperature, and Current Limit Protection
- TDFN34-16 Package
- -40°C to +85°C Temperature Range

Applications

- Bluetooth™ Headsets
- Cellular Phones
- Handheld Instruments
- MP3 and Portable Music Players
- PDAs and Handheld Computers
- Portable Media Players

Typical Application

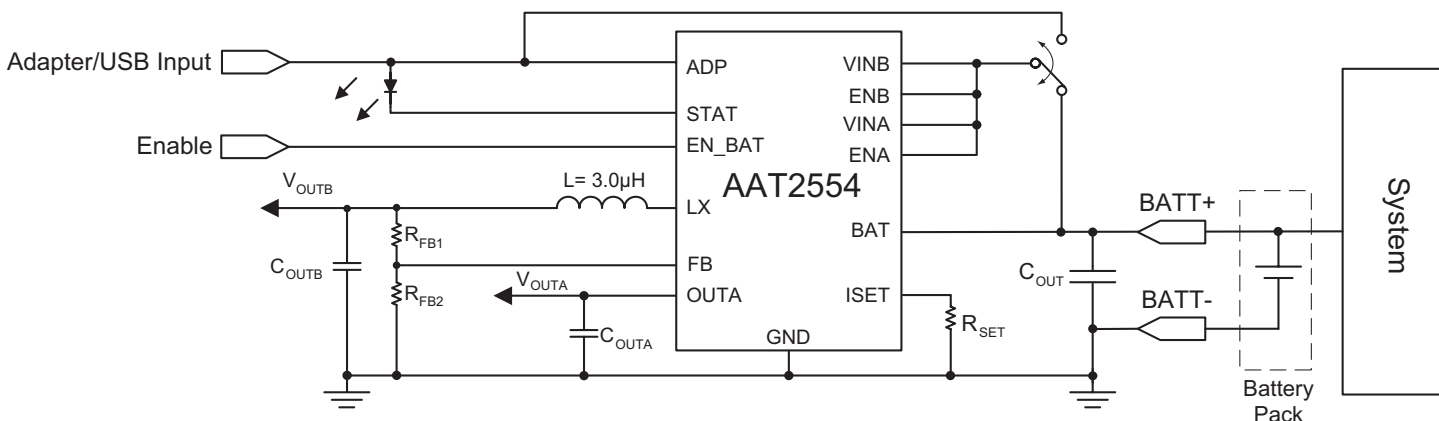

AAT2554

Total Power Solution for Portable Applications

Pin Descriptions

Pin #	Symbol	Function
1	FB	Feedback input. This pin must be connected directly to an external resistor divider. Nominal voltage is 0.6V.
2, 10, 12, 14	GND	Ground.
3	ENB	Enable pin for the step-down converter. When connected to logic low, the step-down converter is disabled and consumes less than 1µA of current. When connected to logic high, the converter resumes normal operation.
4	VINA	Linear regulator input voltage. Connect a 1µF or greater capacitor from this pin to ground.
5	OUTA	Linear regulator output. Connect a 2.2µF capacitor from this pin to ground.
6	EN_BAT	Enable pin for the battery charger. When connected to logic low, the battery charger is disabled and consumes less than 1µA of current. When connected to logic high, the charger resumes normal operation.
7	ISET	Charge current set point. Connect a resistor from this pin to ground. Refer to the Typical Characteristics curves for resistor selection.
8	BAT	Battery charging and sensing.
9	STAT	Charge status input. Open drain status output.
11	ADP	Input for USB/adaptor charger.
13	ENA	Enable pin for the linear regulator. When connected to logic low, the regulator is disabled and consumes less than 1µA of current. When connected to logic high, the regulator resumes normal operation.
15	LX	Output of the step-down converter. Connect the inductor to this pin. Internally, it is connected to the drain of both high- and low-side MOSFETs.
16	VINB	Input voltage for the step-down converter.
EP		Exposed paddle (bottom); connect to ground directly beneath the package.

Pin Configuration

**TDFN34-16
(Top View)**

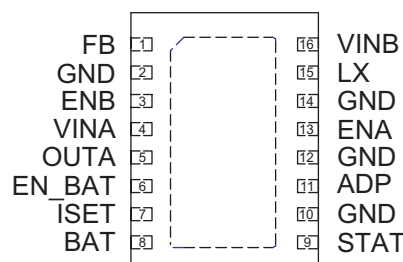

*Total Power Solution for Portable Applications***Absolute Maximum Ratings¹**

Symbol	Description	Value	Units
V_{INA}, V_{INB}	Input Voltage to GND	6.0	V
V_{ADP}	Adapter Voltage to GND	-0.3 to 7.5	V
V_{LX}	LX to GND	-0.3 to $V_{IN} + 0.3$	V
V_{FB}	FB to GND	-0.3 to $V_{IN} + 0.3$	V
V_{EN}	ENA, ENB, EN_BAT to GND	-0.3 to 6.0	V
V_X	BAT, ISET, STAT	-0.3 to $V_{ADP} + 0.3$	V
T_J	Operating Junction Temperature Range	-40 to 150	°C
T_{LEAD}	Maximum Soldering Temperature (at leads, 10 sec.)	300	°C

Thermal Information

Symbol	Description	Value	Units
P_D	Maximum Power Dissipation	2.0	W
θ_{JA}	Thermal Resistance ²	50	°C/W

1. Stresses above those listed in Absolute Maximum Ratings may cause permanent damage to the device. Functional operation at conditions other than the operating conditions specified is not implied. Only one Absolute Maximum Rating should be applied at any one time.
2. Mounted on an FR4 board.

Total Power Solution for Portable Applications

Electrical Characteristics¹

$V_{INB} = 3.6V$; $T_A = -40^{\circ}C$ to $+85^{\circ}C$, unless otherwise noted. Typical values are $T_A = 25^{\circ}C$.

Symbol	Description	Conditions	Min	Typ	Max	Units
Step-Down Converter						
V_{IN}	Input Voltage		2.7		5.5	V
V_{UVLO}	UVLO Threshold	V_{INB} Rising			2.7	V
		Hysteresis		200		mV
		V_{INB} Falling	1.8			V
V_{OUT}	Output Voltage Tolerance ²	$I_{OUTB} = 0$ to $250mA$, $V_{INB} = 2.7V$ to $5.5V$	-3.0		3.0	%
V_{OUT}	Output Voltage Range		0.6		V_{INB}	V
I_Q	Quiescent Current	No Load		30		μA
I_{SHDN}	Shutdown Current	ENB = GND			1.0	μA
I_{LIM}	P-Channel Current Limit			600		mA
$R_{DS(ON)H}$	High-Side Switch On-Resistance			0.59		Ω
$R_{DS(ON)L}$	Low-Side Switch On-Resistance			0.42		Ω
I_{LXLEAK}	LX Leakage Current	$V_{INB} = 5.5V$, $V_{LX} = 0$ to V_{INB}			1.0	μA
$\frac{\Delta V_{Linereg}}{\Delta V_{IN}}$	Line Regulation	$V_{INB} = 2.7V$ to $5.5V$		0.2		%/V
V_{FB}	Feedback Threshold Voltage Accuracy	$V_{INB} = 3.6V$	0.591	0.6	0.609	V
I_{FB}	FB Leakage Current	$V_{OUTB} = 1.0V$			0.2	μA
F_{OSC}	Oscillator Frequency			1.5		MHz
T_S	Startup Time	From Enable to Output Regulation		100		μs
T_{SD}	Over-Temperature Shutdown Threshold			140		$^{\circ}C$
T_{HYS}	Over-Temperature Shutdown Hysteresis			15		$^{\circ}C$
$V_{EN(L)}$	Enable Threshold Low				0.6	V
$V_{EN(H)}$	Enable Threshold High		1.4			V
I_{EN}	Input Low Current	$V_{INB} = V_{ENB} = 5.5V$	-1.0		1.0	μA

1. The AAT2554 is guaranteed to meet performance specifications over the $-40^{\circ}C$ to $+85^{\circ}C$ operating temperature range and is assured by design, characterization, and correlation with statistical process controls.

2. Output voltage tolerance is independent of feedback resistor network accuracy.

Total Power Solution for Portable Applications

Electrical Characteristics¹

$V_{IN} = V_{OUT(NOM)} + 1V$ for V_{OUT} options greater than 1.5V. $I_{OUT} = 1mA$, $C_{OUT} = 2.2\mu F$, $C_{IN} = 1\mu F$, $T_A = -40^{\circ}C$ to $+85^{\circ}C$, unless otherwise noted. Typical values are $T_A = 25^{\circ}C$.

Symbol	Description	Conditions	Min	Typ	Max	Units	
Linear Regulator							
V_{OUT}	Output Voltage Tolerance	$I_{OUTA} = 1mA$ to 300mA	$T_A = 25^{\circ}C$	-1.5		1.5	%
			$T_A = -40^{\circ}C$ to $+85^{\circ}C$	-2.5		2.5	
V_{IN}	Input Voltage		V_{OUT} $+ V_{DO}^2$		5.5	V	
V_{DO}	Dropout Voltage ³	$I_{OUTA} = 300mA$		400	600	mV	
$\frac{\Delta V_{OUT}}{V_{OUT}} * \Delta V_{IN}$	Line Regulation	$V_{INA} = V_{OUTA} + 1$ to 5.0V		0.09		%/V	
$\Delta V_{OUT(LINE)}$	Dynamic Line Regulation	$I_{OUTA} = 300mA$, $V_{INA} = V_{OUTA} + 1$ to $V_{OUTA} + 2$, $T_R/T_F = 2\mu s$		2.5		mV	
$\Delta V_{OUT(LOAD)}$	Dynamic Load Regulation	$I_{OUTA} = 1mA$ to 300mA, $T_R < 5\mu s$		60		mV	
I_{OUT}	Output Current	$V_{OUTA} > 1.2V$	300			mA	
I_{SC}	Short-Circuit Current	$V_{OUTA} < 0.4V$		600		mA	
I_Q	Quiescent Current	$V_{INA} = 5V$; $ENA = V_{IN}$		70	125	μA	
I_{SHDN}	Shutdown Current	$V_{INA} = 5V$; $ENA = 0V$			1.0	μA	
PSRR	Power Supply Rejection Ratio	$I_{OUTA} = 10mA$	1kHz		65		
			10kHz		45		
			1MHz		43		
T_{SD}	Over-Temperature Shutdown Threshold			145		$^{\circ}C$	
T_{HYS}	Over-Temperature Shutdown Hysteresis			12		$^{\circ}C$	
e_N	Output Noise			250		μV_{RMS}	
T_C	Output Voltage Temperature Coefficient			22		ppm/ $^{\circ}C$	
T_{EN_DLY}	Enable Time Delay			15		μs	
$V_{EN(L)}$	Enable Threshold Low				0.6	V	
$V_{EN(H)}$	Enable Threshold High		1.5			V	
I_{EN}	Enable Input Current	$V_{ENA} = 5.5V$			1.0	μA	

1. The AAT2554 is guaranteed to meet performance specifications over the $-40^{\circ}C$ to $+85^{\circ}C$ operating temperature range and is assured by design, characterization, and correlation with statistical process controls.
2. V_{DO} is defined as $V_{IN} - V_{OUT}$ when V_{OUT} is 98% of nominal.
3. For $V_{OUT} < 2.3V$, $V_{DO} = 2.5V - V_{OUT}$.

Total Power Solution for Portable Applications

Electrical Characteristics¹

$V_{INB} = 3.6V$; $T_A = -40^{\circ}C$ to $+85^{\circ}C$, unless otherwise noted. Typical values are $T_A = 25^{\circ}C$.

Symbol	Description	Conditions	Min	Typ	Max	Units
Battery Charger						
Operation						
V_{ADP}	Adapter Voltage Range		4.0		6.5	V
V_{UVLO}	Under-Voltage Lockout (UVLO)	Rising Edge	3		4	V
	UVLO Hysteresis			150		mV
I_{OP}	Operating Current	Charge Current = 200mA		0.5	1	mA
$I_{SHUTDOWN}$	Shutdown Current	$V_{BAT} = 4.25V$, EN_BAT = GND		0.3	1	μA
$I_{LEAKAGE}$	Reverse Leakage Current from BAT Pin	$V_{BAT} = 4V$, ADP Pin Open		0.4	2	μA
Voltage Regulation						
V_{BAT_EOC}	End of Charge Accuracy		4.158	4.20	4.242	V
$\Delta V_{CH}/V_{CH}$	Output Charge Voltage Tolerance			0.5		%
V_{MIN}	Preconditioning Voltage Threshold		2.85	3.0	3.15	V
V_{RCH}	Battery Recharge Voltage Threshold	Measured from V_{BAT_EOC}		-0.1		V
Current Regulation						
I_{CH}	Charge Current Programmable Range		15		500	mA
$\Delta I_{CH}/I_{CH}$	Charge Current Regulation Tolerance			10		%
V_{SET}	ISET Pin Voltage			2		V
K_{I_A}	Current Set Factor: I_{CH}/I_{SET}			800		
Charging Devices						
$R_{DS(ON)}$	Charging Transistor On Resistance	$V_{ADP} = 5.5V$		0.9	1.1	Ω
Logic Control/Protection						
$V_{EN(H)}$	Enable Threshold High		1.6			V
$V_{EN(L)}$	Enable Threshold Low				0.4	V
V_{STAT}	Output Low Voltage	STAT Pin Sinks 4mA			0.4	V
I_{STAT}	STAT Pin Current Sink Capability				8	mA
V_{OVP}	Over-Voltage Protection Threshold			4.4		V
I_{TK}/I_{CHG}	Pre-Charge Current	$I_{CH} = 100mA$		10		%
I_{TERM}/I_{CHG}	Charge Termination Threshold Current			10		%

1. The AAT2554 is guaranteed to meet performance specifications over the $-40^{\circ}C$ to $+85^{\circ}C$ operating temperature range and is assured by design, characterization, and correlation with statistical process controls.

Typical Characteristics – Step-Down Converter

Efficiency vs. Load
($V_{OUT} = 1.8V$; $L = 3.3\mu H$)

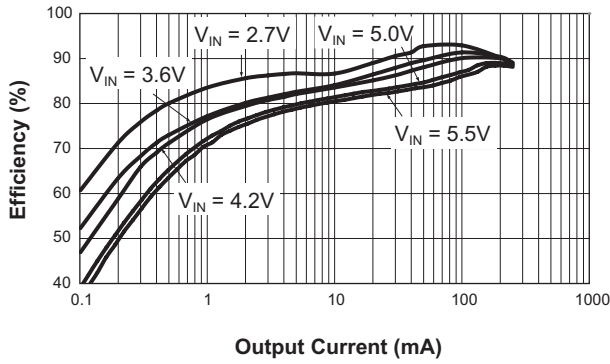

DC Load Regulation
($V_{OUT} = 1.8V$; $L = 3.3\mu H$)

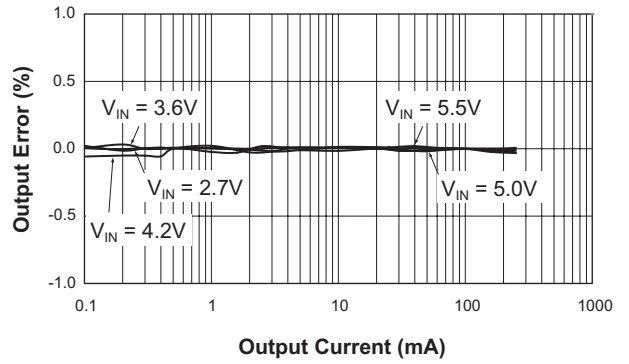

Efficiency vs. Load
($V_{OUT} = 1.2V$; $L = 1.5\mu H$)

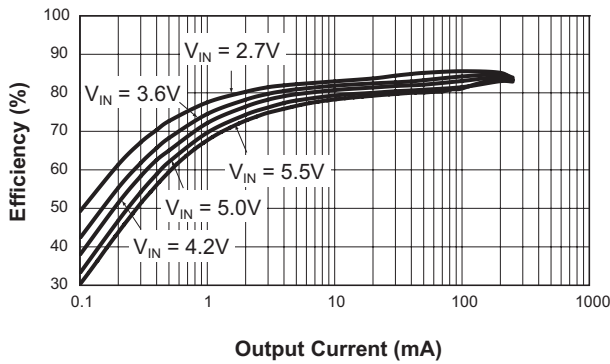

DC Load Regulation
($V_{OUT} = 1.2V$; $L = 1.5\mu H$)

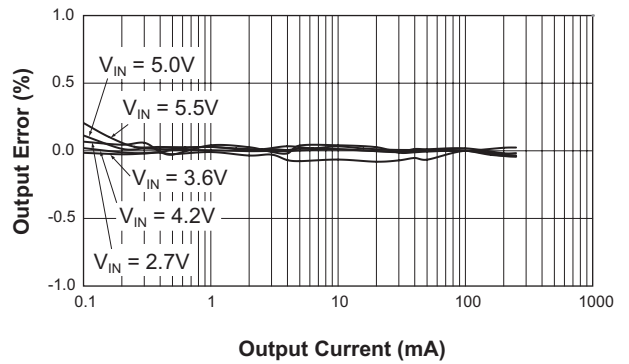

Soft Start
($V_{IN} = 3.6V$; $V_{OUT} = 1.8V$;
 $I_{OUT} = 250mA$; $C_{FF} = 100pF$)

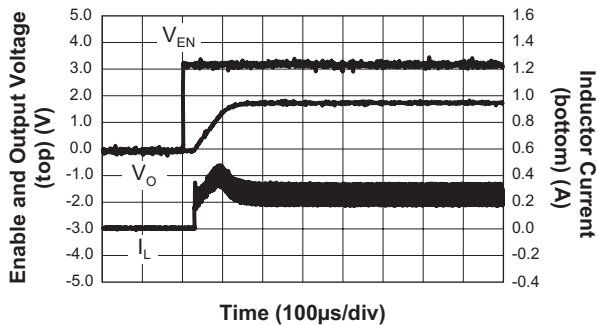

Line Regulation
($V_{OUT} = 1.8V$)

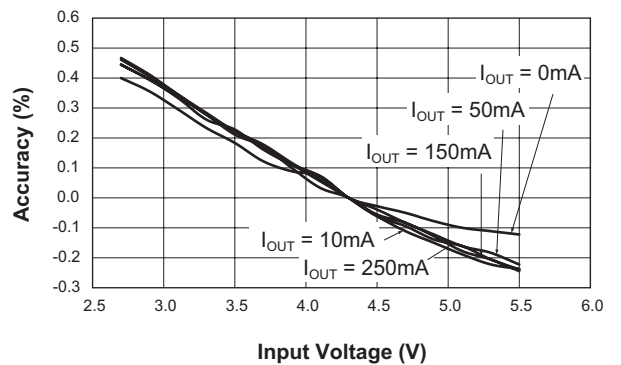

Total Power Solution for Portable Applications

Typical Characteristics – Step-Down Converter

Output Voltage Error vs. Temperature
($V_{INB} = 3.6V$; $V_{OUT} = 1.8V$; $I_{OUT} = 250mA$)

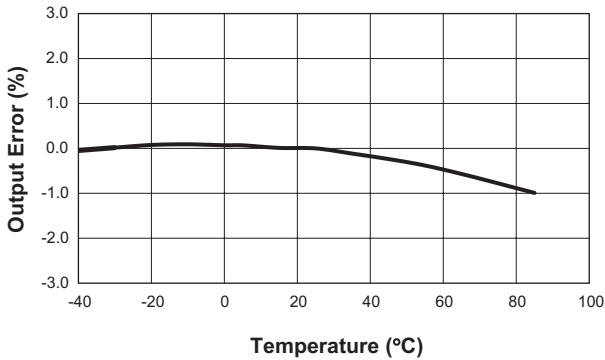

Switching Frequency Variation vs. Temperature
($V_{IN} = 3.6V$; $V_{OUT} = 1.8V$)

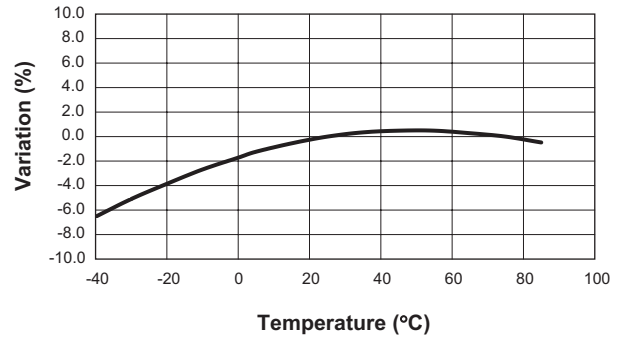

Frequency Variation vs. Input Voltage
($V_{OUT} = 1.8V$)

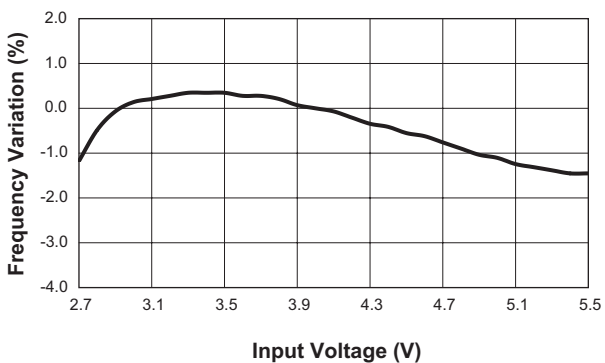

No Load Quiescent Current vs. Input Voltage

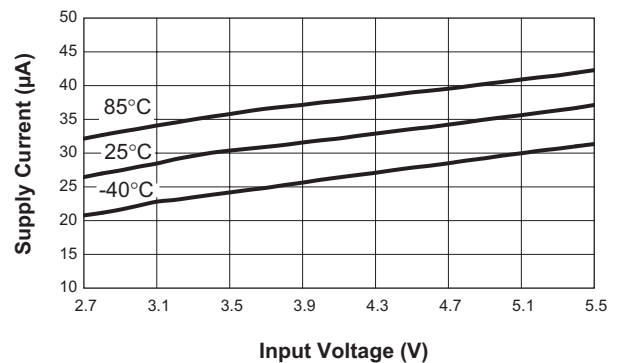

P-Channel $R_{DS(ON)}$ vs. Input Voltage

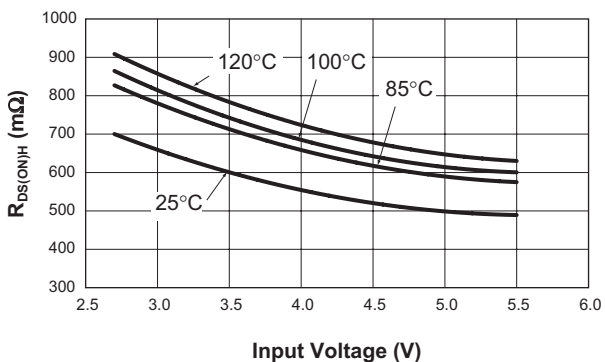

N-Channel $R_{DS(ON)}$ vs. Input Voltage

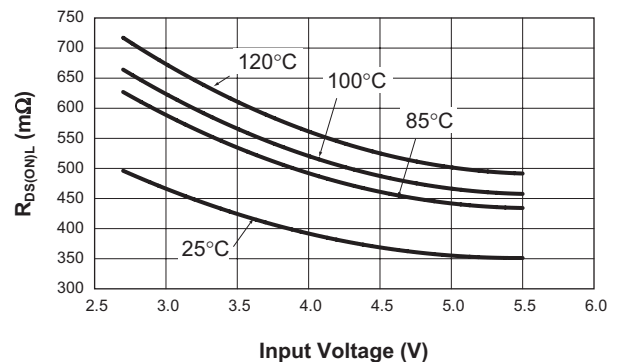

Typical Characteristics – Step-Down Converter

Load Transient Response
 (10mA to 250mA; $V_{IN} = 3.6V$; $V_{OUT} = 1.8V$;
 $C_{OUT} = 4.7\mu F$; $C_{FF} = 100pF$)

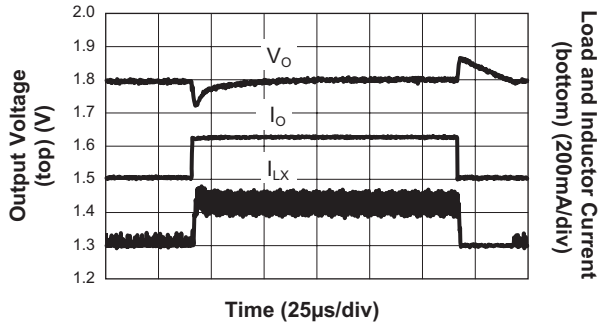

Load Transient Response
 (10mA to 250mA; $V_{IN} = 3.6V$; $V_{OUT} = 1.8V$; $C_{OUT} = 4.7\mu F$)

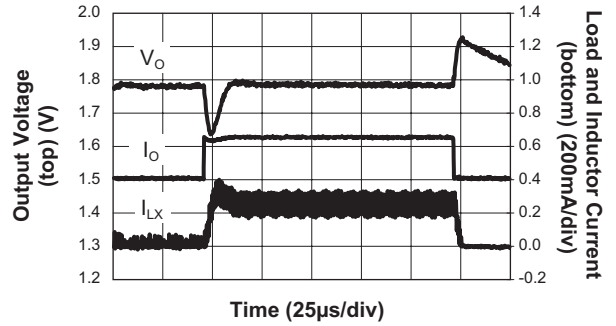

Line Response
 ($V_{OUT} = 1.8V$ @ 250mA; $C_{FF} = 100pF$)

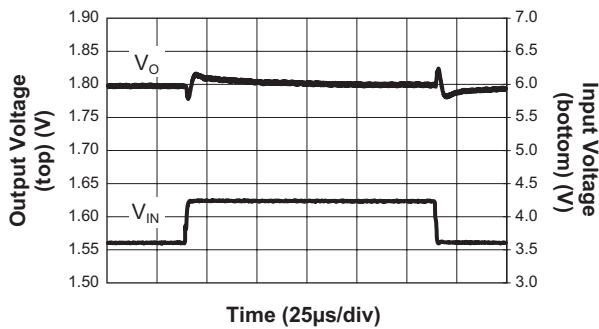

Output Ripple
 ($V_{IN} = 3.6V$; $V_{OUT} = 1.8V$; $I_{OUT} = 1mA$)

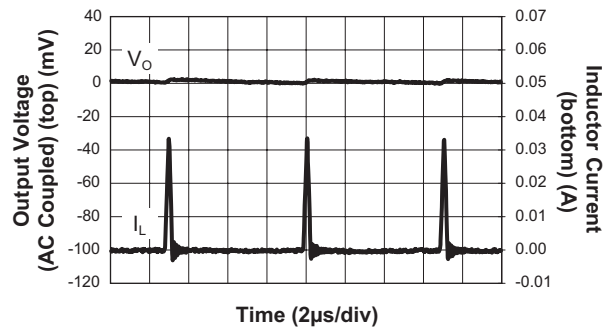

Output Ripple
 ($V_{IN} = 3.6V$; $V_{OUT} = 1.8V$; $I_{OUT} = 250mA$)

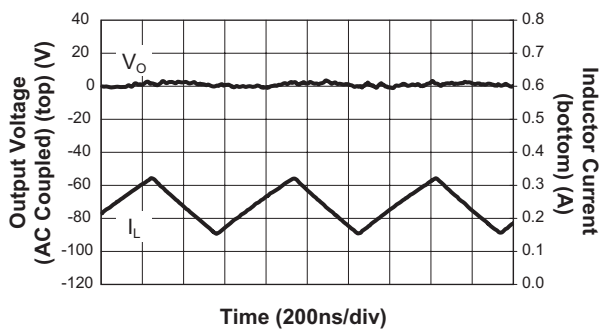

Typical Characteristics – Battery Charger

Constant Charging Current vs. Set Resistor Values

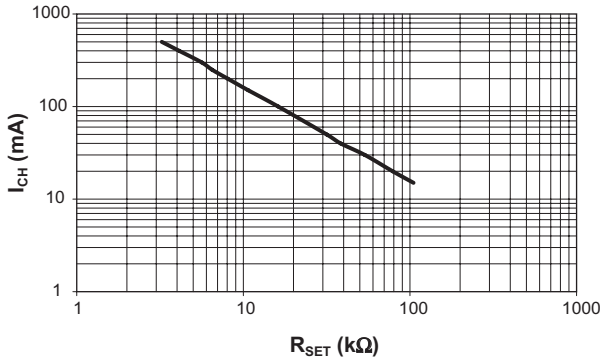

Charging Current vs. Battery Voltage
($V_{ADP} = 5V$)

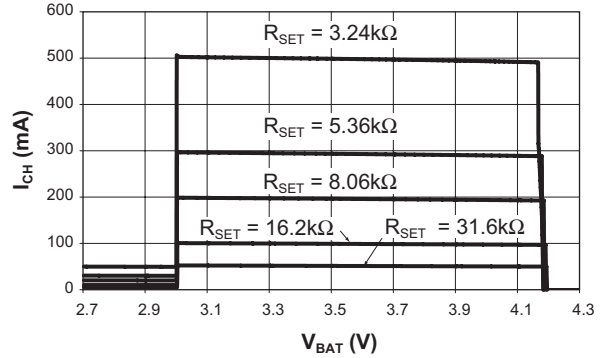

End of Charge Battery Voltage vs. Supply Voltage

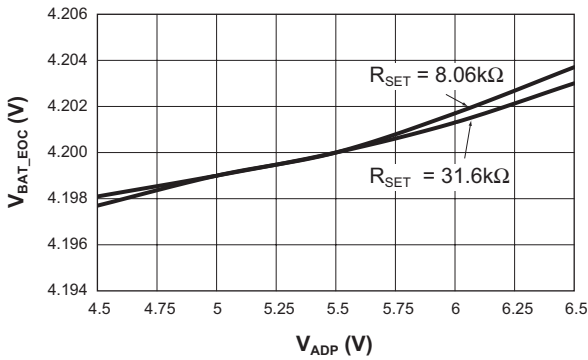

End of Charge Voltage Regulation vs. Temperature
($R_{SET} = 8.06k\Omega$)

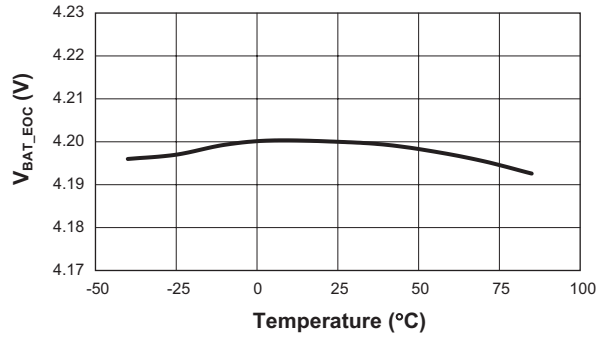

Constant Charging Current vs. Supply Voltage
($R_{SET} = 8.06k\Omega$)

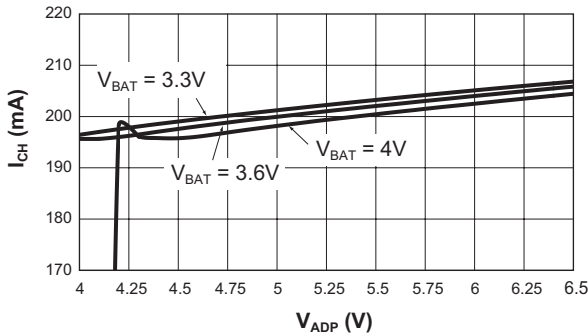

Constant Charging Current vs. Temperature
($R_{SET} = 8.06k\Omega$)

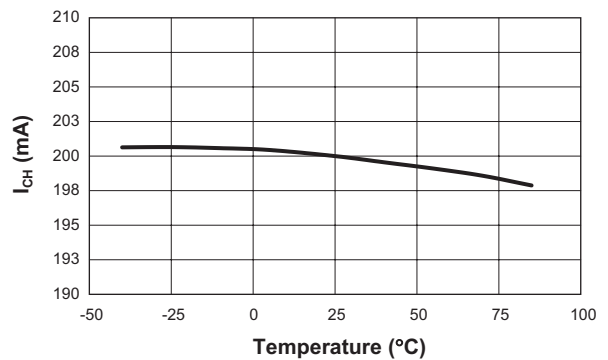

Typical Characteristics – Battery Charger

Operating Current vs. Temperature
 ($R_{SET} = 8.06k\Omega$)

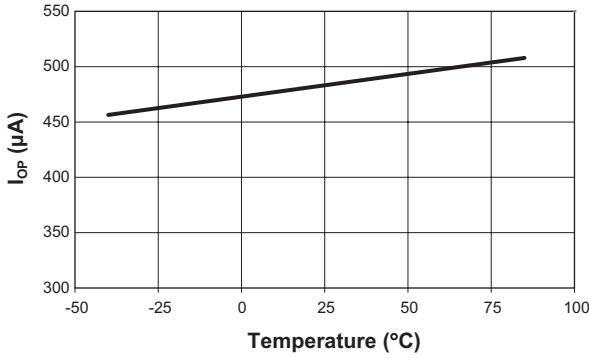

Preconditioning Threshold Voltage vs. Temperature
 ($R_{SET} = 8.06k\Omega$)

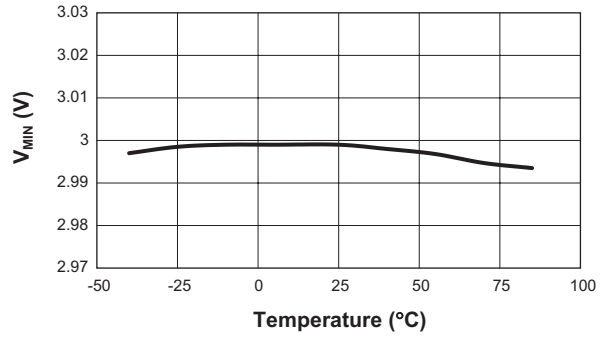

Preconditioning Charge Current vs. Temperature
 ($R_{SET} = 8.06k\Omega$)

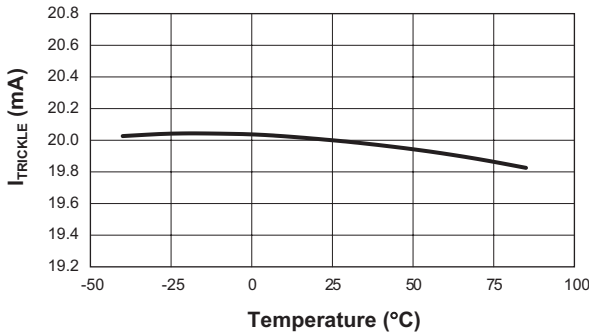

Preconditioning Charge Current vs. Supply Voltage

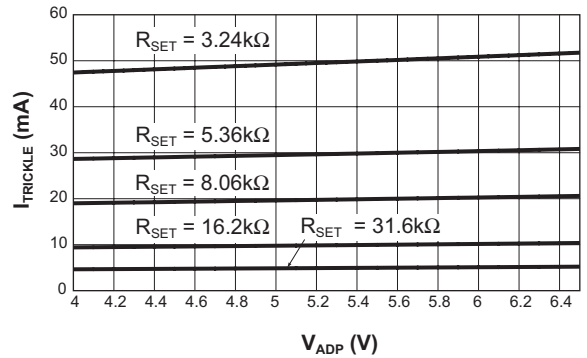

Recharging Threshold Voltage vs. Temperature
 ($R_{SET} = 8.06k\Omega$)

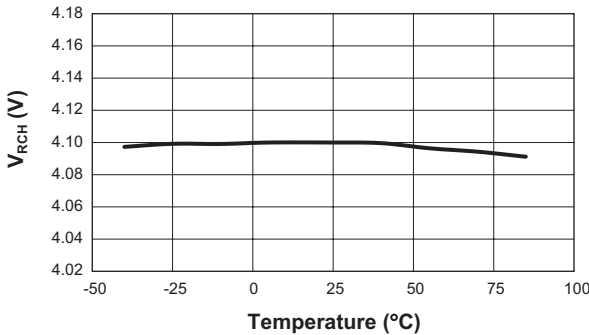

Sleep Mode Current vs. Supply Voltage
 ($R_{SET} = 8.06k\Omega$)

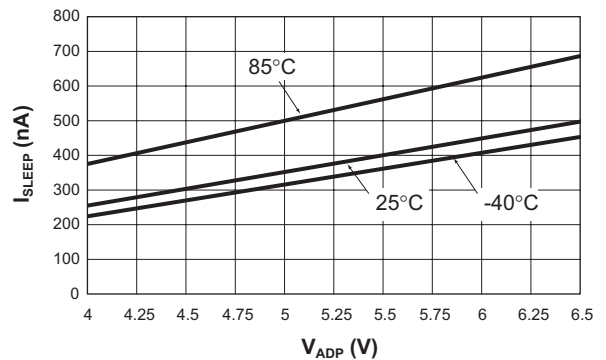

Typical Characteristics – Battery Charger

$V_{EN(H)}$ vs. Supply Voltage
($R_{SET} = 8.06k\Omega$)

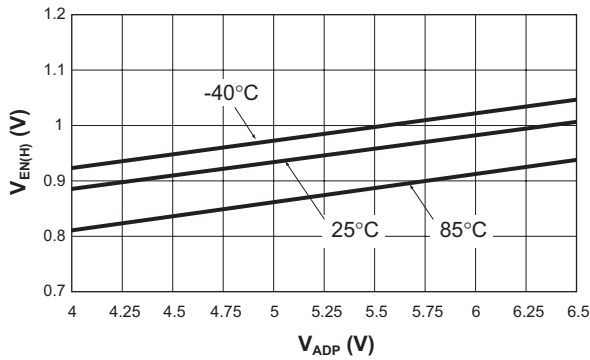

$V_{EN(L)}$ vs. Supply Voltage
($R_{SET} = 8.06k\Omega$)

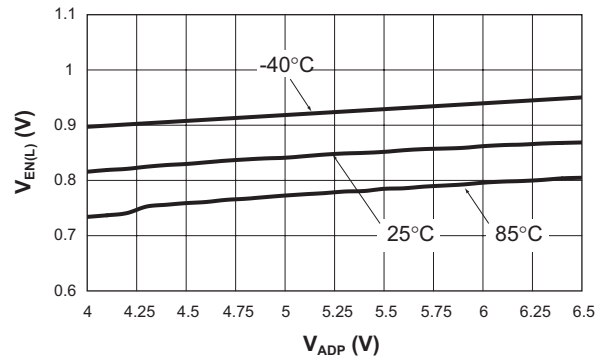

Typical Characteristics – LDO Regulator

Dropout Voltage vs. Temperature

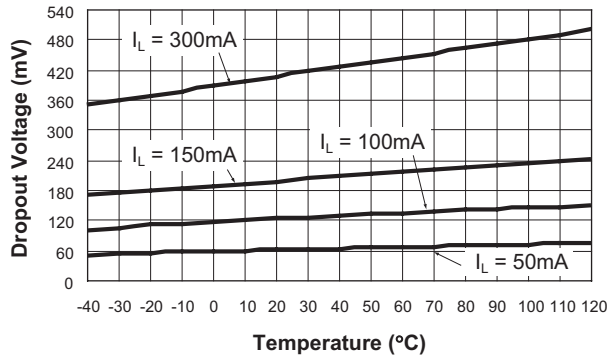

LDO Dropout Characteristics
(EN = GND; ENLDO = V_{IN})

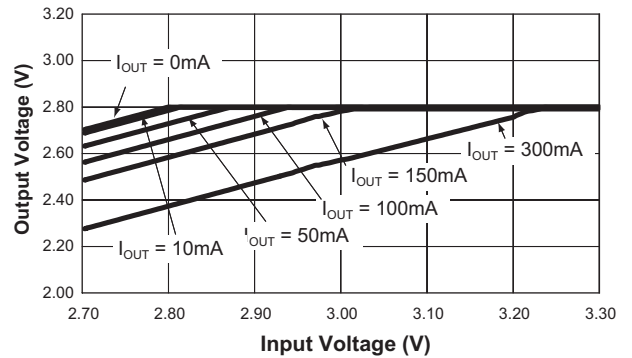

Dropout Voltage vs. Output Current

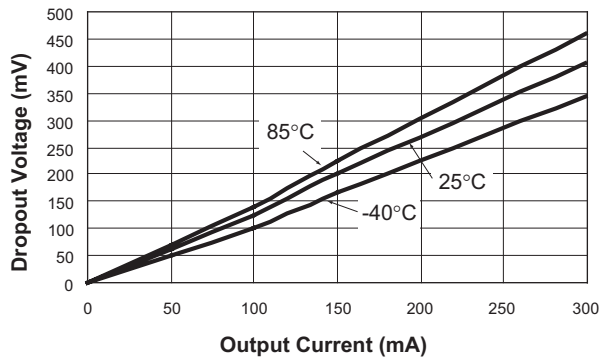

Ground Current vs. Input Voltage

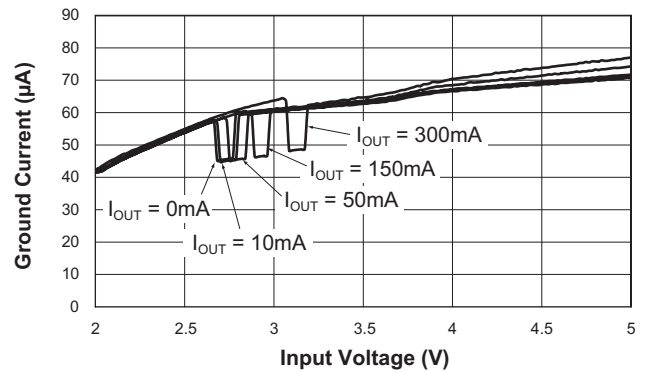

Quiescent Current vs. Temperature

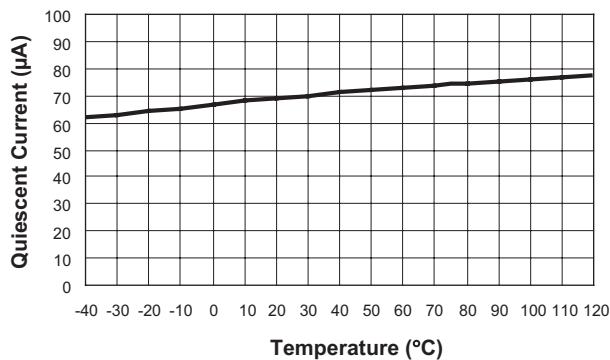

Output Voltage vs. Temperature

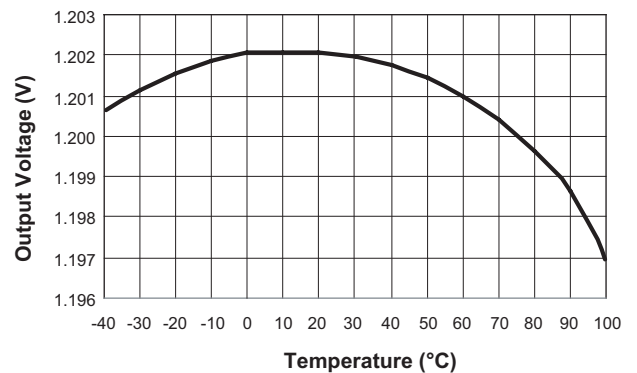

Typical Characteristics – LDO Regulator

LDO Initial Power-Up Response Time

($C_{BYP} = 10nF$; $EN = GND$; $ENLDO = V_{IN}$)

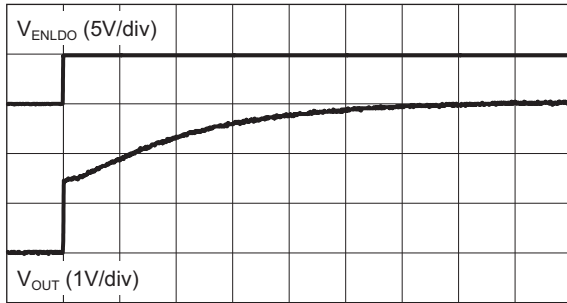

Time (400µs/div)

LDO Turn-On Time from Enable

(V_{IN} Present)

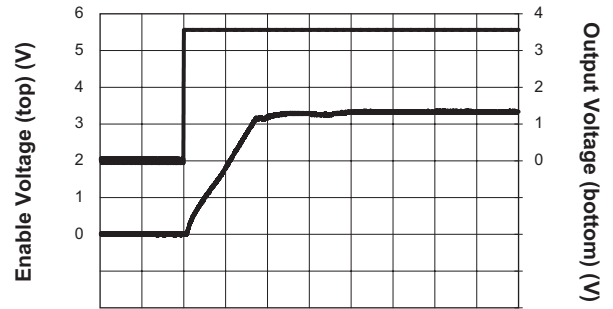

Time (5µs/div)

Turn-Off Response Time

($I = 100mA$)

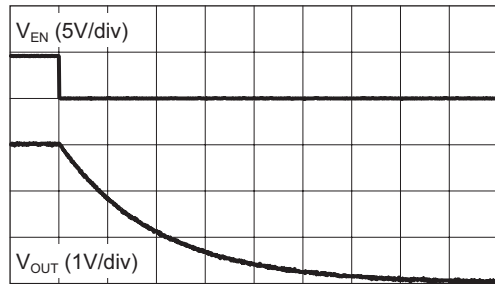

Time (50µs/div)

Line Transient Response

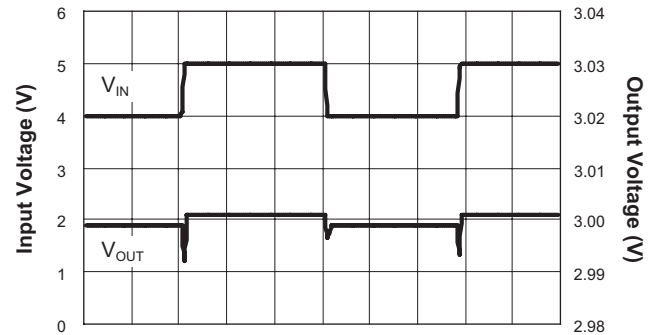

Time (100µs/div)

Load Transient Response

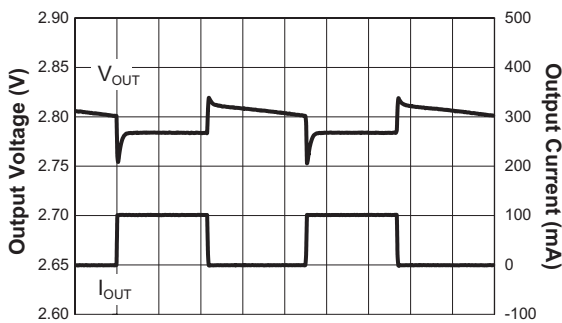

Time (100µs/div)

Load Transient Response 300mA

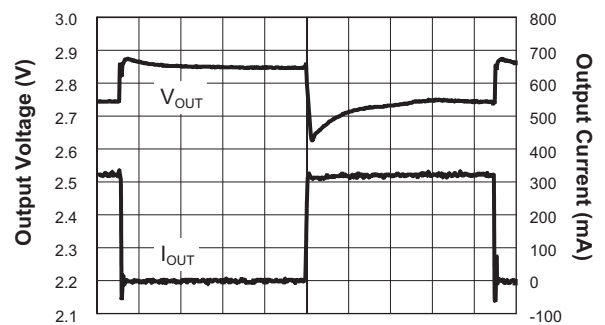

Time (10µs/div)

Typical Characteristics – LDO Regulator

Over-Current Protection
(EN = GND; ENLDO = V_{IN})

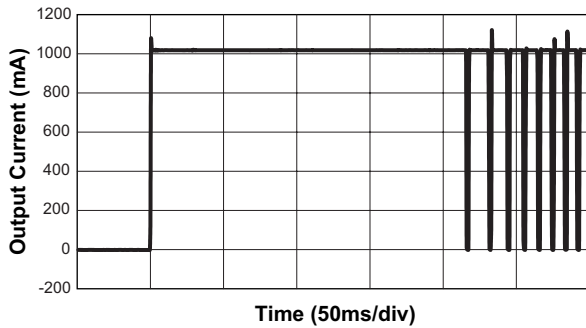

V_{EN(L)} and V_{EN(H)} vs. V_{IN}

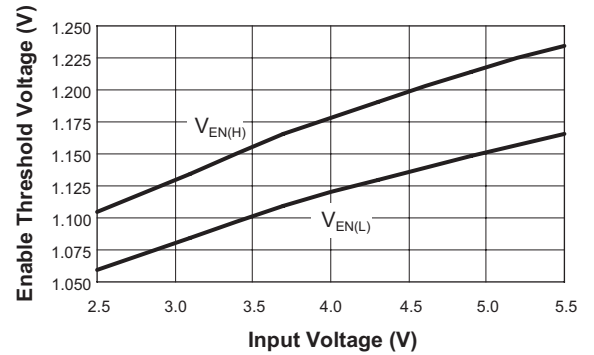

Total Power Solution for Portable Applications

mable from V_{IN} to as low as 0.6V. Power devices are sized for 250mA current capability while maintaining over 90% efficiency at full load. Light load efficiency is maintained at greater than 80% down to 1mA of load current. A high-DC gain error amplifier with internal compensation controls the output. It provides excellent transient response and load/line regulation.

Linear Regulator

The advanced circuit design of the linear regulator has been specifically optimized for very fast start-up. This proprietary CMOS LDO has also been tailored for superior transient response characteristics. These traits are particularly important for applications that require fast power supply timing.

The high-speed turn-on capability is enabled through implementation of a fast-start control circuit which accelerates the power-up behavior of fundamental control and feedback circuits within the LDO regulator. The LDO regulator output has been specifically optimized to function with low-cost, low-ESR ceramic capacitors; however, the design will allow for operation over a wide range of capacitor types.

The regulator comes with complete short-circuit and thermal protection. The combination of these two internal protection circuits gives a comprehensive safety system to guard against extreme adverse operating conditions.

The regulator features an enable/disable function. This pin (ENA) is active high and is compatible with CMOS logic. To assure the LDO regulator will switch on, the ENA turn-on control level must be greater than 1.5V. The LDO regulator will go into the disable shutdown mode when the voltage on the ENA pin falls below 0.6V. If the enable function is not needed in a specific application, it may be tied to V_{INA} to keep the LDO regulator in a continuously on state.

Under-Voltage Lockout

The AAT2554 has internal circuits for UVLO and power on reset features. If the ADP supply voltage drops below the UVLO threshold, the battery charger will suspend charging and shut down. When power is reapplied to the ADP pin or the UVLO condition recovers, the system charge control will automatically resume charging in the appropriate mode for the condition of the battery. If the input voltage of the step-down converter drops below UVLO, the internal circuit will shut down.

Protection Circuitry**Over-Voltage Protection**

An over-voltage protection event is defined as a condition where the voltage on the BAT pin exceeds the over-voltage protection threshold (V_{OVP}). If this over-voltage condition occurs, the charger control circuitry will shut down the device. The charger will resume normal charging operation after the over-voltage condition is removed.

Current Limit, Over-Temperature Protection

For overload conditions, the peak input current is limited at the step-down converter. As load impedance decreases and the output voltage falls closer to zero, more power is dissipated internally, which causes the internal die temperature to rise. In this case, the thermal protection circuit completely disables switching, which protects the device from damage.

The battery charger has a thermal protection circuit which will shut down charging functions when the internal die temperature exceeds the preset thermal limit threshold. Once the internal die temperature falls below the thermal limit, normal charging operation will resume.

Control Loop

The AAT2554 contains a compact, current mode step-down DC/DC controller. The current through the P-channel MOSFET (high side) is sensed for current loop control, as well as short-circuit and overload protection. A fixed slope compensation signal is added to the sensed current to maintain stability for duty cycles greater than 50%. The peak current mode loop appears as a voltage-programmed current source in parallel with the output capacitor. The output of the voltage error amplifier programs the current mode loop for the necessary peak switch current to force a constant output voltage for all load and line conditions. Internal loop compensation terminates the transconductance voltage error amplifier output. The error amplifier reference is fixed at 0.6V.

Battery Charging Operation

Battery charging commences only after checking several conditions in order to maintain a safe charging environment. The input supply (ADP) must be above the minimum operating voltage (UVLO) and the enable pin must be high (internally pulled down). When the battery is connected to the BAT pin, the charger checks the condition of the battery and determines which charging mode

Total Power Solution for Portable Applications

to apply. If the battery voltage is below V_{MIN} , the charger begins battery pre-conditioning by charging at 10% of the programmed constant current; e.g., if the programmed current is 150mA, then the pre-conditioning current (trickle charge) is 15mA. Pre-conditioning is purely a safety precaution for a deeply discharged cell and will also reduce the power dissipation in the internal series pass MOSFET when the input-output voltage differential is at its highest.

Pre-conditioning continues until the battery voltage reaches V_{MIN} (see Figure 1). At this point, the charger begins constant-current charging. The current level for this mode is programmed using a single resistor from the ISET pin to ground. Programmed current can be set from a minimum 15mA up to a maximum of 500mA. Constant current charging will continue until the battery voltage reaches the voltage regulation point, V_{BAT} . When

the battery voltage reaches V_{BAT} , the battery charger begins constant voltage mode. The regulation voltage is factory programmed to a nominal 4.2V ($\pm 0.5\%$) and will continue charging until the charging current has reduced to 10% of the programmed current.

After the charge cycle is complete, the pass device turns off and the device automatically goes into a power-saving sleep mode. During this time, the series pass device will block current in both directions, preventing the battery from discharging through the IC.

The battery charger will remain in sleep mode, even if the charger source is disconnected, until one of the following events occurs: the battery terminal voltage drops below the V_{RCH} threshold; the charger EN pin is recycled; or the charging source is reconnected. In all cases, the charger will monitor all parameters and resume charging in the most appropriate mode.

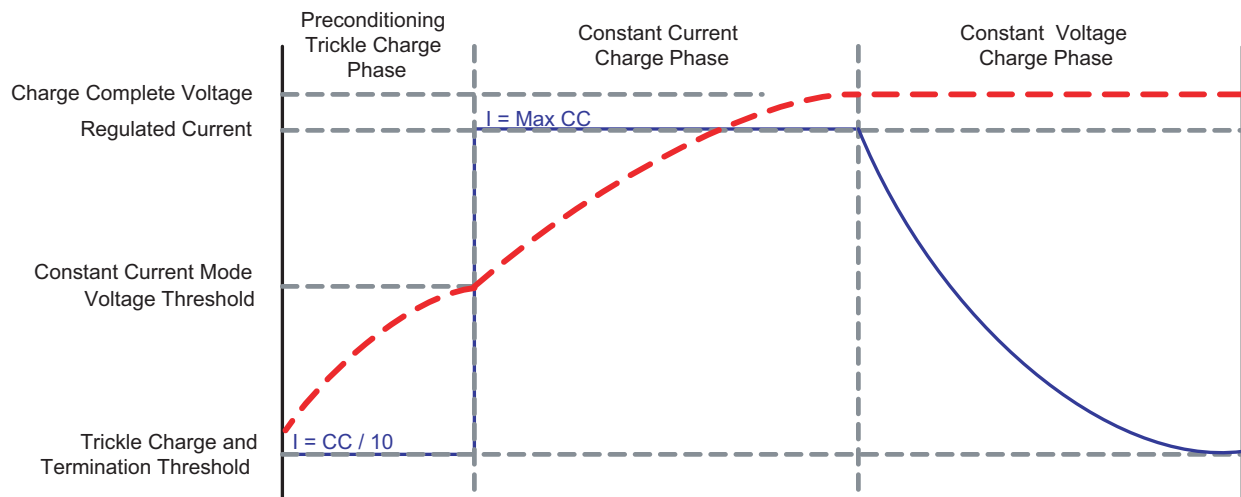
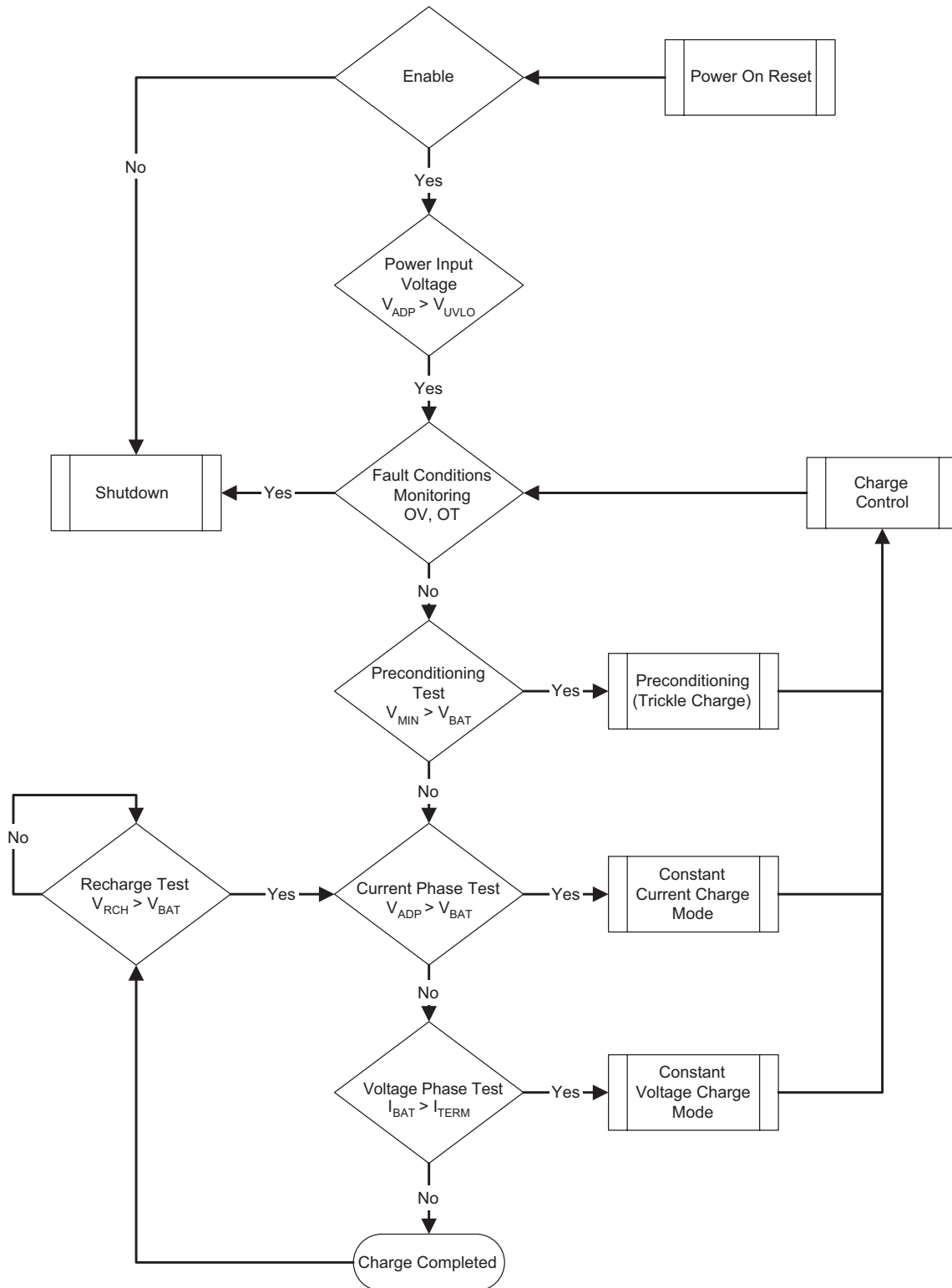

Figure 1: Current vs. Voltage Profile During Charging Phases.

Battery Charging System Operation Flow Chart



Total Power Solution for Portable Applications

Application Information

Soft Start / Enable

The EN_BAT pin is internally pulled down. When pulled to a logic high level, the battery charger is enabled. When left open or pulled to a logic low level, the battery charger is shut down and forced into the sleep state. Charging will be halted regardless of the battery voltage or charging state. When it is re-enabled, the charge control circuit will automatically reset and resume charging functions with the appropriate charging mode based on the battery charge state and measured cell voltage from the BAT pin.

Separate ENA and ENB inputs are provided to independently enable and disable the LDO and step-down converter, respectively. This allows sequencing of the LDO and step-down outputs during startup.

The LDO is enabled when the ENA pin is pulled high. The control and feedback circuits have been optimized for high-speed, monotonic turn-on characteristics.

The step-down converter is enabled when the ENB pin is pulled high. Soft start increases the inductor current limit point in discrete steps when the input voltage or ENB input is applied. It limits the current surge seen at the input and eliminates output voltage overshoot. When pulled low, the ENB input forces the AAT2554 into a low-power, non-switching state. The total input current during shutdown is less than 1µA.

Adapter or USB Power Input

Constant current charge levels up to 500mA may be programmed by the user when powered from a sufficient input power source. The battery charger will operate from the adapter input over a 4.0V to 6.5V range. The constant current fast charge current for the adapter input is set by the R_{SET} resistor connected between ISET and ground. Refer to Table 1 for recommended R_{SET} values for a desired constant current charge level.

Programming Charge Current

The fast charge constant current charge level is user programmed with a set resistor placed between the ISET pin and ground. The accuracy of the fast charge, as well as the preconditioning trickle charge current, is dominated by the tolerance of the set resistor used. For this

reason, a 1% tolerance metal film resistor is recommended for the set resistor function. Fast charge constant current levels from 15mA to 500mA may be set by selecting the appropriate resistor value from Table 1.

Normal I _{CHARGE} (mA)	Set Resistor Value R1 (kΩ)
500	3.24
400	4.12
300	5.36
250	6.49
200	8.06
150	10.7
100	16.2
50	31.6
40	38.3
30	53.6
20	78.7
15	105

Table 1: R_{SET} Values.

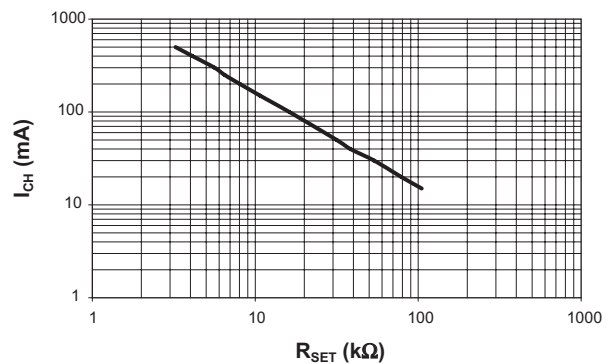

Figure 2: Constant Charging Current vs. Set Resistor Values.

Charge Status Output

The AAT2554 provides battery charge status via a status pin. This pin is internally connected to an N-channel open drain MOSFET, which can be used to drive an external LED. The status pin can indicate several conditions, as shown in Table 2.

Event Description	Status
No battery charging activity	OFF
Battery charging via adapter	ON or USB port
Charging completed	OFF

Table 2: LED Status Indicator.

Total Power Solution for Portable Applications

The LED should be biased with as little current as necessary to create reasonable illumination; therefore, a ballast resistor should be placed between the LED cathode and the STAT pin. LED current consumption will add to the overall thermal power budget for the device package, hence it is good to keep the LED drive current to a minimum. 2mA should be sufficient to drive most low-cost green or red LEDs. It is not recommended to exceed 8mA for driving an individual status LED.

The required ballast resistor values can be estimated using the following formulas:

$$R_1 = \frac{(V_{ADP} - V_{F(LED)})}{I_{LED}}$$

Example:

$$R_1 = \frac{(5.5V - 2.0V)}{2mA} = 1.75k\Omega$$

Note: Red LED forward voltage (V_F) is typically 2.0V @ 2mA.

Thermal Considerations

The AAT2554 is offered in a TDFN34-16 package which can provide up to 2W of power dissipation when it is properly bonded to a printed circuit board and has a maximum thermal resistance of 50°C/W. Many considerations should be taken into account when designing the printed circuit board layout, as well as the placement of the charger IC package in proximity to other heat generating devices in a given application design. The ambient temperature around the IC will also have an effect on the thermal limits of a battery charging application. The maximum limits that can be expected for a given ambient condition can be estimated by the following discussion.

First, the maximum power dissipation for a given situation should be calculated:

$$P_{D(MAX)} = \frac{(T_{J(MAX)} - T_A)}{\theta_{JA}}$$

Where:

$P_{D(MAX)}$ = Maximum Power Dissipation (W)

θ_{JA} = Package Thermal Resistance (°C/W)

$T_{J(MAX)}$ = Maximum Device Junction Temperature (°C)
[135°C]

T_A = Ambient Temperature (°C)

Figure 3 shows the relationship of maximum power dissipation and ambient temperature of the AAT2554.

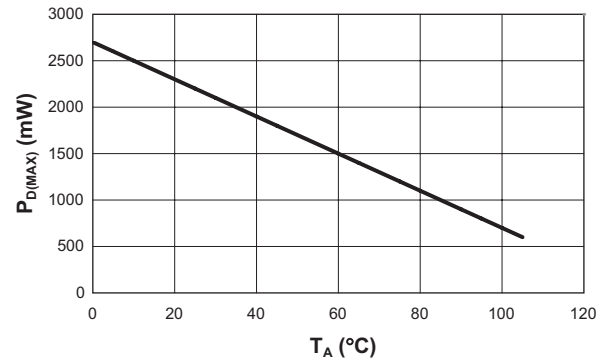

Figure 3: Maximum Power Dissipation.

Next, the power dissipation of the battery charger can be calculated by the following equation:

$$P_D = [(V_{ADP} - V_{BAT}) \cdot I_{CH} + (V_{ADP} \cdot I_{OP})]$$

Where:

P_D = Total Power Dissipation by the Device

V_{ADP} = ADP/USB Voltage

V_{BAT} = Battery Voltage as Seen at the BAT Pin

I_{CH} = Constant Charge Current Programmed for the Application

I_{OP} = Quiescent Current Consumed by the Charger IC for Normal Operation [0.5mA]

By substitution, we can derive the maximum charge current before reaching the thermal limit condition (thermal cycling). The maximum charge current is the key factor when designing battery charger applications.

$$I_{CH(MAX)} = \frac{(P_{D(MAX)} - V_{IN} \cdot I_{OP})}{V_{IN} - V_{BAT}}$$

$$I_{CH(MAX)} = \frac{\frac{(T_{J(MAX)} - T_A)}{\theta_{JA}} - V_{IN} \cdot I_{OP}}{V_{IN} - V_{BAT}}$$

In general, the worst condition is the greatest voltage drop across the IC, when battery voltage is charged up to the preconditioning voltage threshold. Figure 4 shows the maximum charge current in different ambient temperatures.

Total Power Solution for Portable Applications

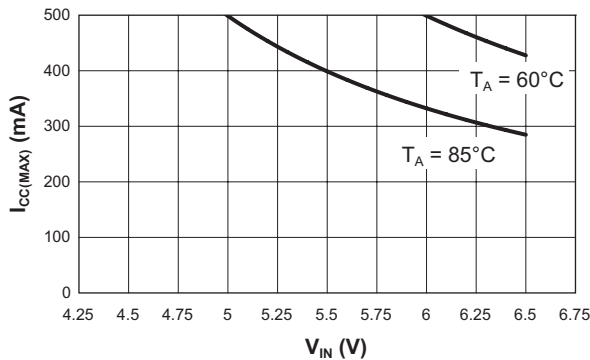

Figure 4: Maximum Charging Current Before Thermal Cycling Becomes Active.

There are three types of losses associated with the step-down converter: switching losses, conduction losses, and quiescent current losses. Conduction losses are associated with the $R_{DS(ON)}$ characteristics of the power output switching devices. Switching losses are dominated by the gate charge of the power output switching devices. At full load, assuming continuous conduction mode (CCM), a simplified form of the losses is given by:

$$P_{TOTAL} = \frac{I_O^2 \cdot (R_{DSON(H)} \cdot V_O + R_{DSON(L)} \cdot [V_{IN} - V_O])}{V_{IN}} + (t_{sw} \cdot F_S \cdot I_O + I_Q) \cdot V_{IN}$$

I_Q is the step-down converter quiescent current. The term t_{sw} is used to estimate the full load step-down converter switching losses.

For the condition where the step-down converter is in dropout at 100% duty cycle, the total device dissipation reduces to:

$$P_{TOTAL} = I_O^2 \cdot R_{DSON(H)} + I_Q \cdot V_{IN}$$

Since $R_{DS(ON)}$, quiescent current, and switching losses all vary with input voltage, the total losses should be investigated over the complete input voltage range.

Given the total losses, the maximum junction temperature can be derived from the θ_{JA} for the TDFN34-16 package which is 50°C/W.

$$T_{J(MAX)} = P_{TOTAL} \cdot \theta_{JA} + T_{AMB}$$

Capacitor Selection

Linear Regulator Input Capacitor (C7)

An input capacitor greater than 1 μ F will offer superior input line transient response and maximize power supply ripple rejection. Ceramic, tantalum, or aluminum electrolytic capacitors may be selected for C_{IN} . There is no specific capacitor ESR requirement for C_{IN} . However, for 300mA LDO regulator output operation, ceramic capacitors are recommended for C_{IN} due to their inherent capability over tantalum capacitors to withstand input current surges from low impedance sources such as batteries in portable devices.

Battery Charger Input Capacitor (C3)

In general, it is good design practice to place a decoupling capacitor between the ADP pin and GND. An input capacitor in the range of 1 μ F to 22 μ F is recommended. If the source supply is unregulated, it may be necessary to increase the capacitance to keep the input voltage above the under-voltage lockout threshold during device enable and when battery charging is initiated. If the adapter input is to be used in a system with an external power supply source, such as a typical AC-to-DC wall adapter, then a C_{IN} capacitor in the range of 10 μ F should be used. A larger input capacitor in this application will minimize switching or power transient effects when the power supply is "hot plugged" in.

Step-Down Converter Input Capacitor (C1)

Select a 4.7 μ F to 10 μ F X7R or X5R ceramic capacitor for the input. To estimate the required input capacitor size, determine the acceptable input ripple level (V_{PP}) and solve for C_{IN} . The calculated value varies with input voltage and is a maximum when V_{IN} is double the output voltage.

$$C_{IN} = \frac{\frac{V_O}{V_{IN}} \cdot \left(1 - \frac{V_O}{V_{IN}}\right)}{\left(\frac{V_{PP}}{I_O} - ESR\right) \cdot F_S}$$

$$\frac{V_O}{V_{IN}} \cdot \left(1 - \frac{V_O}{V_{IN}}\right) = \frac{1}{4} \text{ for } V_{IN} = 2 \cdot V_O$$

$$C_{IN(MIN)} = \frac{1}{\left(\frac{V_{PP}}{I_O} - ESR\right) \cdot 4 \cdot F_S}$$

Total Power Solution for Portable Applications

Always examine the ceramic capacitor DC voltage coefficient characteristics when selecting the proper value. For example, the capacitance of a 10 μ F, 6.3V, X5R ceramic capacitor with 5.0V DC applied is actually about 6 μ F.

The maximum input capacitor RMS current is:

$$I_{\text{RMS}} = I_{\text{O}} \cdot \sqrt{\frac{V_{\text{O}}}{V_{\text{IN}}} \cdot \left(1 - \frac{V_{\text{O}}}{V_{\text{IN}}}\right)}$$

The input capacitor RMS ripple current varies with the input and output voltage and will always be less than or equal to half of the total DC load current.

$$\sqrt{\frac{V_{\text{O}}}{V_{\text{IN}}} \cdot \left(1 - \frac{V_{\text{O}}}{V_{\text{IN}}}\right)} = \sqrt{D \cdot (1 - D)} = \sqrt{0.5^2} = \frac{1}{2}$$

for $V_{\text{IN}} = 2 \cdot V_{\text{O}}$

$$I_{\text{RMS(MAX)}} = \frac{I_{\text{O}}}{2}$$

The term $\frac{V_{\text{O}}}{V_{\text{IN}}} \cdot \left(1 - \frac{V_{\text{O}}}{V_{\text{IN}}}\right)$ appears in both the input voltage ripple and input capacitor RMS current equations and is a maximum when V_{O} is twice V_{IN} . This is why the input voltage ripple and the input capacitor RMS current ripple are a maximum at 50% duty cycle.

The input capacitor provides a low impedance loop for the edges of pulsed current drawn by the step-down converter. Low ESR/ESL X7R and X5R ceramic capacitors are ideal for this function. To minimize stray inductance, the capacitor should be placed as closely as possible to the IC. This keeps the high frequency content of the input current localized, minimizing EMI and input voltage ripple.

The proper placement of the input capacitor (C1) can be seen in the evaluation board layout in Figure 6.

A laboratory test set-up typically consists of two long wires running from the bench power supply to the evaluation board input voltage pins. The inductance of these wires, along with the low-ESR ceramic input capacitor, can create a high Q network that may affect converter performance. This problem often becomes apparent in the form of excessive ringing in the output voltage during load transients. Errors in the loop phase and gain measurements can also result.

Since the inductance of a short PCB trace feeding the input voltage is significantly lower than the power leads from the bench power supply, most applications do not exhibit this problem.

In applications where the input power source lead inductance cannot be reduced to a level that does not affect the converter performance, a high ESR tantalum or aluminum electrolytic capacitor should be placed in parallel with the low ESR, ESL bypass ceramic capacitor. This dampens the high Q network and stabilizes the system.

Linear Regulator Output Capacitor (C6)

For proper load voltage regulation and operational stability, a capacitor is required between OUT and GND. The C_{OUT} capacitor connection to the LDO regulator ground pin should be made as directly as practically possible for maximum device performance. Since the regulator has been designed to function with very low ESR capacitors, ceramic capacitors in the 1.0 μ F to 10 μ F range are recommended for best performance. Applications utilizing the exceptionally low output noise and optimum power supply ripple rejection should use 2.2 μ F or greater for C_{OUT} . In low output current applications, where output load is less than 10mA, the minimum value for C_{OUT} can be as low as 0.47 μ F.

Battery Charger Output Capacitor (C5)

The AAT2554 only requires a 1 μ F ceramic capacitor on the BAT pin to maintain circuit stability. This value should be increased to 10 μ F or more if the battery connection is made any distance from the charger output. If the AAT2554 is to be used in applications where the battery can be removed from the charger, such as with desktop charging cradles, an output capacitor greater than 10 μ F may be required to prevent the device from cycling on and off when no battery is present.

Step-Down Converter Output Capacitor (C4)

The output capacitor limits the output ripple and provides holdup during large load transitions. A 4.7 μ F to 10 μ F X5R or X7R ceramic capacitor typically provides sufficient bulk capacitance to stabilize the output during large load transitions and has the ESR and ESL characteristics necessary for low output ripple. For enhanced transient response and low temperature operation applications, a 10 μ F (X5R, X7R) ceramic capacitor is recommended to stabilize extreme pulsed load conditions.

Total Power Solution for Portable Applications

The output voltage droop due to a load transient is dominated by the capacitance of the ceramic output capacitor. During a step increase in load current, the ceramic output capacitor alone supplies the load current until the loop responds. Within two or three switching cycles, the loop responds and the inductor current increases to match the load current demand. The relationship of the output voltage droop during the three switching cycles to the output capacitance can be estimated by:

$$C_{OUT} = \frac{3 \cdot \Delta I_{LOAD}}{V_{DROOP} \cdot F_S}$$

Once the average inductor current increases to the DC load level, the output voltage recovers. The above equation establishes a limit on the minimum value for the output capacitor with respect to load transients.

The internal voltage loop compensation also limits the minimum output capacitor value to 4.7µF. This is due to its effect on the loop crossover frequency (bandwidth), phase margin, and gain margin. Increased output capacitance will reduce the crossover frequency with greater phase margin.

The maximum output capacitor RMS ripple current is given by:

$$I_{RMS(MAX)} = \frac{1}{2 \cdot \sqrt{3}} \cdot \frac{V_{OUT} \cdot (V_{IN(MAX)} - V_{OUT})}{L \cdot F_S \cdot V_{IN(MAX)}}$$

Dissipation due to the RMS current in the ceramic output capacitor ESR is typically minimal, resulting in less than a few degrees rise in hot-spot temperature.

Inductor Selection

The step-down converter uses peak current mode control with slope compensation to maintain stability for duty cycles greater than 50%. The output inductor value must be selected so the inductor current down slope meets the internal slope compensation requirements. The internal slope compensation for the AAT2554 is 0.45A/µsec. This equates to a slope compensation that is 75% of the inductor current down slope for a 1.8V output and 3.0µH inductor.

$$m = \frac{0.75 \cdot V_O}{L} = \frac{0.75 \cdot 1.8V}{3.0\mu H} = 0.45 \frac{A}{\mu sec}$$

$$L = \frac{0.75 \cdot V_O}{m} = \frac{0.75 \cdot V_O}{0.45A \frac{A}{\mu sec}} \approx 1.67 \frac{\mu sec}{A} \cdot V_O$$

For most designs, the step-down converter operates with inductor values from 1µH to 4.7µH. Table 3 displays inductor values for the AAT2554 for various output voltages.

Manufacturer's specifications list both the inductor DC current rating, which is a thermal limitation, and the peak current rating, which is determined by the saturation characteristics. The inductor should not show any appreciable saturation under normal load conditions. Some inductors may meet the peak and average current ratings yet result in excessive losses due to a high DCR. Always consider the losses associated with the DCR and its effect on the total converter efficiency when selecting an inductor.

The 3.0µH CDRH2D09 series inductor selected from Sumida has a 150mΩ DCR and a 470mA DC current rating. At full load, the inductor DC loss is 9.375mW which gives a 2.08% loss in efficiency for a 250mA, 1.8V output.

Output Voltage (V)	L1 (µH)
1.0	1.5
1.2	2.2
1.5	2.7
1.8	3.0/3.3
2.5	3.9/4.2
3.0	4.7
3.3	5.6

Table 3: Step-Down Converter Inductor Values.

Adjustable Output Resistor Selection

Resistors R2 and R3 of Figure 5 program the output to regulate at a voltage higher than 0.6V. To limit the bias current required for the external feedback resistor string while maintaining good noise immunity, the suggested value for R3 is 59kΩ. Decreased resistor values are necessary to maintain noise immunity on the FB pin, resulting in increased quiescent current. Table 4 summarizes the resistor values for various output voltages.

$$R2 = \left(\frac{V_{OUT}}{V_{REF}} - 1 \right) \cdot R3 = \left(\frac{3.3V}{0.6V} - 1 \right) \cdot 59k\Omega = 267k\Omega$$

With enhanced transient response for extreme pulsed load application, an external feed-forward capacitor (C8 in Figure 5) can be added.

AAT2554

Total Power Solution for Portable Applications

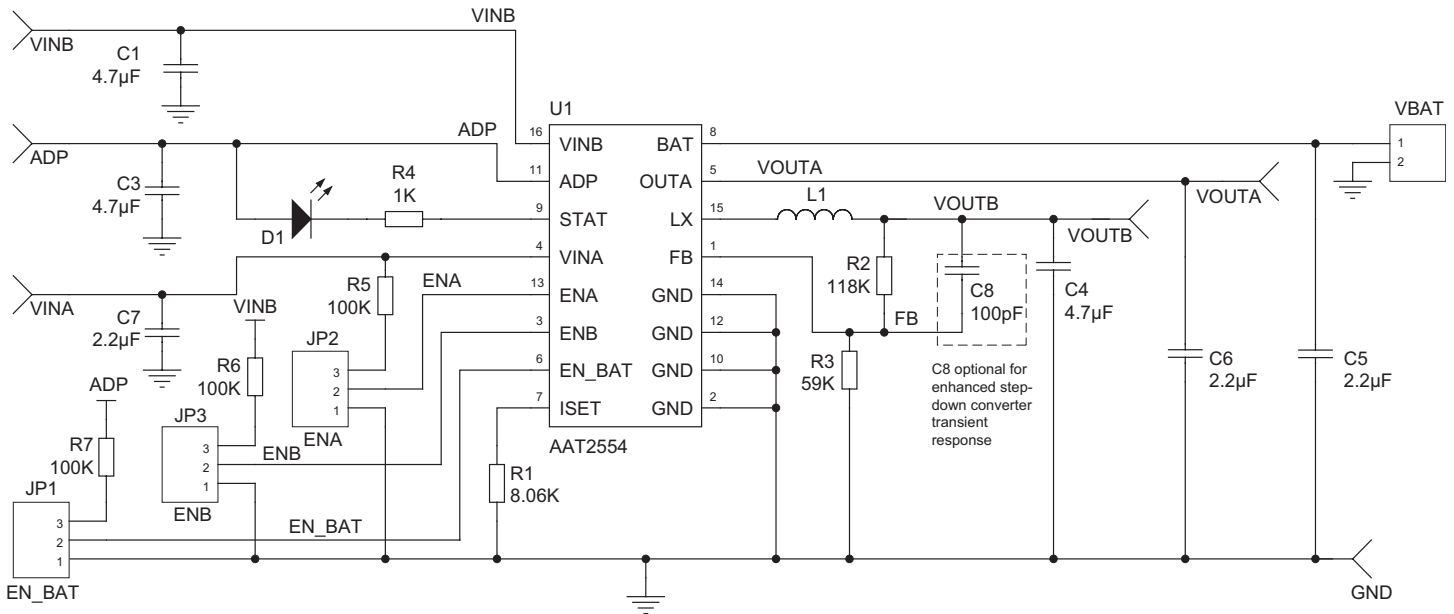

Figure 5: AAT2554 Evaluation Board Schematic.

V _{OUT} (V)	R3 = 59kΩ R2 (kΩ)	R3 = 221kΩ R2 (kΩ)
0.8	19.6	75
0.9	29.4	113
1.0	39.2	150
1.1	49.9	187
1.2	59.0	221
1.3	68.1	261
1.4	78.7	301
1.5	88.7	332
1.8	118	442
1.85	124	464
2.0	137	523
2.5	187	715
3.3	267	1000

Table 4: Adjustable Resistor Values For Step-Down Converter.

Printed Circuit Board Layout Considerations

For the best results, it is recommended to physically place the battery pack as close as possible to the AAT2554 BAT pin. To minimize voltage drops on the PCB, keep the high current carrying traces adequately wide. Refer to the AAT2554 evaluation board for a good layout

example (see Figures 6 and 7). The following guidelines should be used to help ensure a proper layout.

1. The input capacitors (C1, C3, C7) should connect as closely as possible to ADP (Pin 11), VINA (Pin 4), and VINB (Pin 16).
2. C4 and L1 should be connected as closely as possible. The connection of L1 to the LX pin should be as short as possible. Do not make the node small by using narrow trace. The trace should be kept wide, direct, and short.
3. The feedback pin (Pin 1) should be separate from any power trace and connect as closely as possible to the load point. Sensing along a high-current load trace will degrade DC load regulation. Feedback resistors should be placed as closely as possible to the FB pin (Pin 1) to minimize the length of the high impedance feedback trace. If possible, they should also be placed away from the LX (switching node) and inductor to improve noise immunity.
4. The resistance of the trace from the load return GND (Pins 2, 10, 12, and 14) should be kept to a minimum. This will help to minimize any error in DC regulation due to differences in the potential of the internal signal ground and the power ground.
5. A high density, small footprint layout can be achieved using an inexpensive, miniature, non-shielded, high DCR inductor.

AAT2554

Total Power Solution for Portable Applications

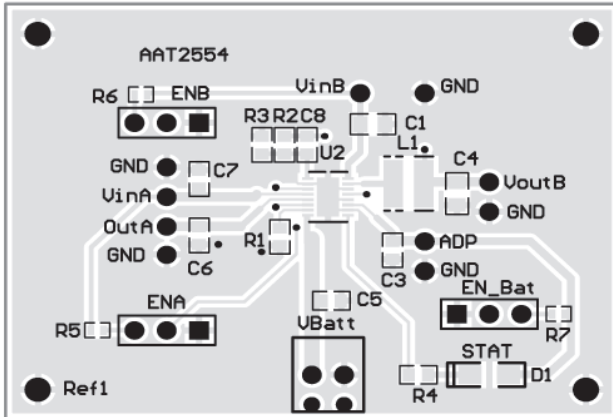

Figure 6: AAT2554 Evaluation Board Top Side Layout.

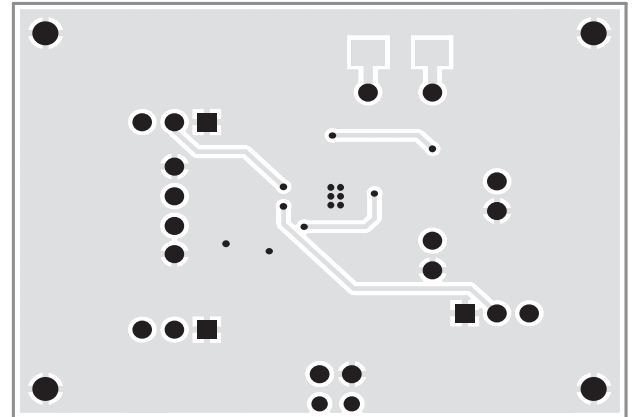

Figure 7: AAT2554 Evaluation Board Bottom Side Layout.

Component	Part Number	Description	Manufacturer
U1	AAT2554IRN-T1	Total Power Solution for Portable Applications	Skyworks
C1, C3, C4	GRM188R60J475KE19	Ceramic 4.7µF 6.3V X5R 0603	Murata
C5, C6, C7	GRM188R61A225KE34	Ceramic 2.2µF 10V X5R 0603	Murata
C8	GRM1886R1H101JZ01J	Ceramic 100pF 50V 5% R2H 0603	Murata
L1	CDRH2D09-3R0	Shielded SMD, 3.0µH, 150mΩ, 3x3x1mm	Sumida
R4	Chip Resistor	1kΩ, 5%, 1/4W; 0603	Vishay
R1	Chip Resistor	8.06kΩ, 1%, 1/4W; 0603	Vishay
R2	Chip Resistor	118kΩ, 1%, 1/4W; 0603	Vishay
R3	Chip Resistor	59kΩ, 1%, 1/4W; 0603	Vishay
R5, R6, R7	Chip Resistor	100kΩ, 5%, 1/8W; 0402	Vishay
JP1, JP2, JP3	PRPN401PAEN	Connecting Header, 2mm zip	Sullins Electronics
D1	CMD15-21SRC/TR8	Red LED; 1206	Chicago Miniature Lamp

Table 5: AAT2554 Evaluation Board Component Listing.

Step-Down Converter Design Example

Specifications

$V_O = 1.8V$ @ 250mA, Pulsed Load $\Delta I_{LOAD} = 200mA$
 $V_{IN} = 2.7V$ to 4.2V (3.6V nominal)
 $F_S = 1.5MHz$
 $T_{AMB} = 85^\circ C$

1.8V Output Inductor

$$L_1 = 1.67 \frac{\mu sec}{A} \cdot V_{O2} = 1.67 \frac{\mu sec}{A} \cdot 1.8V = 3\mu H \text{ (use } 3.0\mu H; \text{ see Table 3)}$$

For Sumida inductor CDRH2D09-3R0, 3.0 μ H, DCR = 150m Ω .

$$\Delta I_{L1} = \frac{V_O}{L_1 \cdot F_S} \cdot \left(1 - \frac{V_O}{V_{IN}}\right) = \frac{1.8V}{3.0\mu H \cdot 1.5MHz} \cdot \left(1 - \frac{1.8V}{4.2V}\right) = 228mA$$

$$I_{PKL1} = I_O + \frac{\Delta I_{L1}}{2} = 250mA + 114mA = 364mA$$

$$P_{L1} = I_O^2 \cdot DCR = 250mA^2 \cdot 150m\Omega = 9.375mW$$

1.8V Output Capacitor

$$V_{DROOP} = 0.1V$$

$$C_{OUT} = \frac{3 \cdot \Delta I_{LOAD}}{V_{DROOP} \cdot F_S} = \frac{3 \cdot 0.2A}{0.1V \cdot 1.5MHz} = 4\mu F \text{ (use } 4.7\mu F)$$

$$I_{RMS} = \frac{1}{2 \cdot \sqrt{3}} \cdot \frac{(V_O) \cdot (V_{IN(MAX)} - V_O)}{L_1 \cdot F_S \cdot V_{IN(MAX)}} = \frac{1}{2 \cdot \sqrt{3}} \cdot \frac{1.8V \cdot (4.2V - 1.8V)}{3.0\mu H \cdot 1.5MHz \cdot 4.2V} = 66mArms$$

$$P_{esr} = esr \cdot I_{RMS}^2 = 5m\Omega \cdot (66mA)^2 = 21.8\mu W$$

Input Capacitor

Input Ripple $V_{pp} = 25mV$

$$C_{IN} = \frac{1}{\left(\frac{V_{PP}}{I_O} - ESR\right) \cdot 4 \cdot F_S} = \frac{1}{\left(\frac{25mV}{0.2A} - 5m\Omega\right) \cdot 4 \cdot 1.5MHz} = 1.38\mu F \text{ (use } 4.7\mu F)$$

$$I_{RMS} = \frac{I_O}{2} = 0.1Arms$$

$$P = esr \cdot I_{RMS}^2 = 5m\Omega \cdot (0.1A)^2 = 0.05mW$$

AAT2554 Losses

$$P_{\text{TOTAL}} = \frac{I_{\text{O}}^2 \cdot (R_{\text{DSON(H)}} \cdot V_{\text{O}} + R_{\text{DSON(L)}} \cdot [V_{\text{IN}} - V_{\text{O}}])}{V_{\text{IN}}} + (t_{\text{sw}} \cdot F_{\text{S}} \cdot I_{\text{O}} + I_{\text{Q}}) \cdot V_{\text{IN}}$$

$$= \frac{0.2^2 \cdot (0.59\Omega \cdot 1.8\text{V} + 0.42\Omega \cdot [4.2\text{V} - 1.8\text{V}])}{4.2\text{V}} + (5\text{ns} \cdot 1.5\text{MHz} \cdot 0.2\text{A} + 30\mu\text{A}) \cdot 4.2\text{V} = 26.14\text{mW}$$

$$T_{\text{J(MAX)}} = T_{\text{AMB}} + \Theta_{\text{JA}} \cdot P_{\text{LOSS}} = 85^{\circ}\text{C} + (50^{\circ}\text{C/W}) \cdot 26.14\text{mW} = 86.3^{\circ}\text{C}$$

Total Power Solution for Portable Applications

V _{OUT} (V)	R2 (kΩ)	R2 (kΩ)	L1 (μH)
0.6	0	0	1.5
0.8	19.6	75	1.5
0.9	29.4	113	1.5
1.0	39.2	150	1.5
1.1	49.9	187	1.5
1.2	59.0	221	1.5
1.3	68.1	261	1.5
1.4	78.7	301	2.2
1.5	88.7	332	2.7
1.8	118	442	3.0/3.3
1.85	124	464	3.0/3.3
2.0	137	523	3.0/3.3
2.5	187	715	3.9/4.2
3.3	267	1000	5.6

Table 6: Step-Down Converter Component Values.

Manufacturer	Part Number	Inductance (μH)	Max DC Current (mA)	DCR (mΩ)	Size (mm) LxWxH	Type
Sumida	CDRH2D09-1R5	1.5	730	110	3.0x3.0x1.0	Shielded
Sumida	CDRH2D09-2R2	2.2	600	144	3.0x3.0x1.0	Shielded
Sumida	CDRH2D09-2R5	2.5	530	150	3.0x3.0x1.0	Shielded
Sumida	CDRH2D09-3R0	3.0	470	194	3.0x3.0x1.0	Shielded
Sumida	CDRH2D09-3R9	3.9	450	225	3.0x3.0x1.0	Shielded
Sumida	CDRH2D09-4R7	4.7	410	287	3.0x3.0x1.0	Shielded
Sumida	CDRH2D09-5R6	5.6	370	325	3.0x3.0x1.0	Shielded
Sumida	CDRH2D11-1R5	1.5	900	68	3.2x3.2x1.2	Shielded
Sumida	CDRH2D11-2R2	2.2	780	98	3.2x3.2x1.2	Shielded
Sumida	CDRH2D11-3R3	3.3	600	123	3.2x3.2x1.2	Shielded
Sumida	CDRH2D11-4R7	4.7	500	170	3.2x3.2x1.2	Shielded
Taiyo Yuden	NR3010T1R5N	1.5	1200	80	3.0x3.0x1.0	Shielded
Taiyo Yuden	NR3010T2R2M	2.2	1100	95	3.0x3.0x1.0	Shielded
Taiyo Yuden	NR3010T3R3M	3.3	870	140	3.0x3.0x1.0	Shielded
Taiyo Yuden	NR3010T4R7M	4.7	750	190	3.0x3.0x1.0	Shielded
FDK	MIPWT3226D-1R5	1.5	1200	90	3.2x2.6x0.8	Chip shielded
FDK	MIPWT3226D-2R2	2.2	1100	100	3.2x2.6x0.8	Chip shielded
FDK	MIPWT3226D-3R0	3.0	1000	120	3.2x2.6x0.8	Chip shielded
FDK	MIPWT3226D-4R2	4.2	900	140	3.2x2.6x0.8	Chip shielded

Table 7: Suggested Inductors and Suppliers.

Manufacturer	Part Number	Value (μF)	Voltage Rating	Temp. Co.	Case Size
Murata	GRM21BR61A106KE19	10	10	X5R	0805
Murata	GRM188R60J475KE19	4.7	6.3	X5R	0603
Murata	GRM188R61A225KE34	2.2	10	X5R	0603
Murata	GRM188R60J225KE19	2.2	6.3	X5R	0603
Murata	GRM188R61A105KA61	1.0	10	X5R	0603
Murata	GRM185R60J105KE26	1.0	6.3	X5R	0603

Table 8: Surface Mount Capacitors.

1. For reduced quiescent current, R3 = 221kΩ.

AAT2554

Total Power Solution for Portable Applications

Ordering Information

Package	Marking ¹	Part Number (Tape and Reel) ^{2, 3}
TDFN34-16	RZXY	AAT2554IRN-CAP-T1
TDFN34-16	SAXY	AAT2554IRN-CAT-T1
TDFN34-16	TOXY	AAT2554IRN-CAW-T1



Skyworks Green™ products are compliant with all applicable legislation and are halogen-free.

For additional information, refer to *Skyworks Definition of Green™*, document number SQ04-0074.

Legend	
Voltage	Code
Adjustable (0.6V)	A
0.9	B
1.2	E
1.5	G
1.8	I
1.9	Y
2.5	N
2.6	O
2.7	P
2.8	Q
2.85	R
2.9	S
3.0	T
3.3	W
4.2	C

1. XYY = assembly and date code.

2. Sample stock is generally held on part numbers listed in **BOLD**.

3. Product not available for U.S. market.

Total Power Solution for Portable Applications

Package Information¹

TDFN34-16

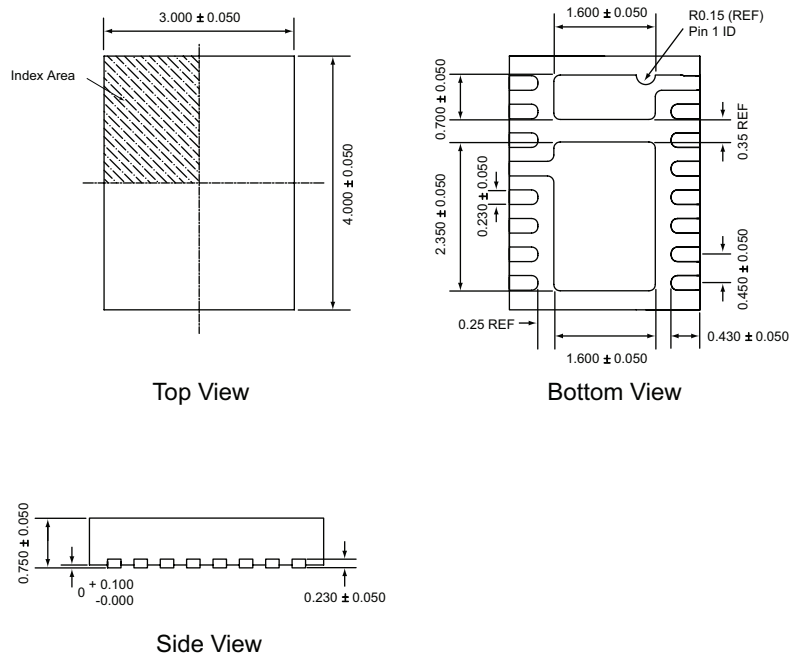

All dimensions in millimeters.

- The leadless package family, which includes QFN, TQFN, DFN, TDFN and STDFN, has exposed copper (unplated) at the end of the lead terminals due to the manufacturing process. A solder fillet at the exposed copper edge cannot be guaranteed and is not required to ensure a proper bottom solder connection.

Copyright © 2012 Skyworks Solutions, Inc. All Rights Reserved.

Information in this document is provided in connection with Skyworks Solutions, Inc. ("Skyworks") products or services. These materials, including the information contained herein, are provided by Skyworks as a service to its customers and may be used for informational purposes only by the customer. Skyworks assumes no responsibility for errors or omissions in these materials or the information contained herein. Skyworks may change its documentation, products, services, specifications or product descriptions at any time, without notice. Skyworks makes no commitment to update the materials or information and shall have no responsibility whatsoever for conflicts, incompatibilities, or other difficulties arising from any future changes.

No license, whether express, implied, by estoppel or otherwise, is granted to any intellectual property rights by this document. Skyworks assumes no liability for any materials, products or information provided hereunder, including the sale, distribution, reproduction or use of Skyworks products, information or materials, except as may be provided in Skyworks Terms and Conditions of Sale.

THE MATERIALS, PRODUCTS AND INFORMATION ARE PROVIDED "AS IS" WITHOUT WARRANTY OF ANY KIND, WHETHER EXPRESS, IMPLIED, STATUTORY, OR OTHERWISE, INCLUDING FITNESS FOR A PARTICULAR PURPOSE OR USE, MERCHANTABILITY, PERFORMANCE, QUALITY OR NON-INFRINGEMENT OF ANY INTELLECTUAL PROPERTY RIGHT; ALL SUCH WARRANTIES ARE HEREBY EXPRESSLY DISCLAIMED. SKYWORKS DOES NOT WARRANT THE ACCURACY OR COMPLETENESS OF THE INFORMATION, TEXT, GRAPHICS OR OTHER ITEMS CONTAINED WITHIN THESE MATERIALS. SKYWORKS SHALL NOT BE LIABLE FOR ANY DAMAGES, INCLUDING BUT NOT LIMITED TO ANY SPECIAL, INDIRECT, INCIDENTAL, STATUTORY, OR CONSEQUENTIAL DAMAGES, INCLUDING WITHOUT LIMITATION, LOST REVENUES OR LOST PROFITS THAT MAY RESULT FROM THE USE OF THE MATERIALS OR INFORMATION, WHETHER OR NOT THE RECIPIENT OF MATERIALS HAS BEEN ADVISED OF THE POSSIBILITY OF SUCH DAMAGE.

Skyworks products are not intended for use in medical, lifesaving or life-sustaining applications, or other equipment in which the failure of the Skyworks products could lead to personal injury, death, physical or environmental damage. Skyworks customers using or selling Skyworks products for use in such applications do so at their own risk and agree to fully indemnify Skyworks for any damages resulting from such improper use or sale.

Customers are responsible for their products and applications using Skyworks products, which may deviate from published specifications as a result of design defects, errors, or operation of products outside of published parameters or design specifications. Customers should include design and operating safeguards to minimize these and other risks. Skyworks assumes no liability for applications assistance, customer product design, or damage to any equipment resulting from the use of Skyworks products outside of stated published specifications or parameters.

Skyworks, the Skyworks symbol, and "Breakthrough Simplicity" are trademarks or registered trademarks of Skyworks Solutions, Inc., in the United States and other countries. Third-party brands and names are for identification purposes only, and are the property of their respective owners. Additional information, including relevant terms and conditions, posted at www.skyworksinc.com, are incorporated by reference.