

High Efficiency 1X/1.5X/2X Charge Pump for White LED Flash Applications

General Description

The AAT3175 is a low noise, constant frequency charge pump DC/DC converter that uses a tri-mode load switch (1X), fractional (1.5X), and doubling (2X) conversion to maximize efficiency for white LED flash applications. The AAT3175 is capable of driving up to three flash LEDs at 300mA total current from a 2.7V to 5.5V input. A low external parts count (two 1µF flying capacitors and two small 1µF capacitors at V_{IN} and V_{OUT}) make this part ideally suited for small battery-powered applications.

Skyworks' S²Cwire™ (Simple Serial Control™) serial digital input is used to enable, disable, and set current for all LEDs with 16 level settings down to 0.

The AAT3175 is equipped with built-in protection for V_{OUT} short-circuit condition and auto-disable for load short-circuit condition on any one of the channels. Built-in soft-start circuitry prevents excessive inrush current during start-up. A low-current shutdown feature disconnects the load from V_{IN} and reduces quiescent current to less than 1µA.

The AAT3175 is available in a Pb-free, space-saving, thermally-enhanced 12-pin 3x3mm TDFN package.

Features

- V_{IN} Range: 2.7V to 5.5V
- Up to 300mA Total Flash Current
- Fully Programmable Current with Single Wire
 - 16 Logarithmic Current Levels
- Tri-Mode 1X, 1.5X, and 2X Charge Pump for Maximum Efficiency and V_F Coverage
- Drives 3-in-1 or 2-in-1 Flash LEDs
 - 0.5% Current Matching
- No Inductors, Low Noise Operation
- 1MHz Constant Switching Frequency
- Small Application Circuit
- Built-In Thermal Protection
- Automatic Soft-Start
- I_Q < 1µA in Shutdown
- TDFN33-12 Package

Applications

- Programmable Current Sinks
- White LED Backlighting
- White Photo Flash for Mobile Phones

Typical Application

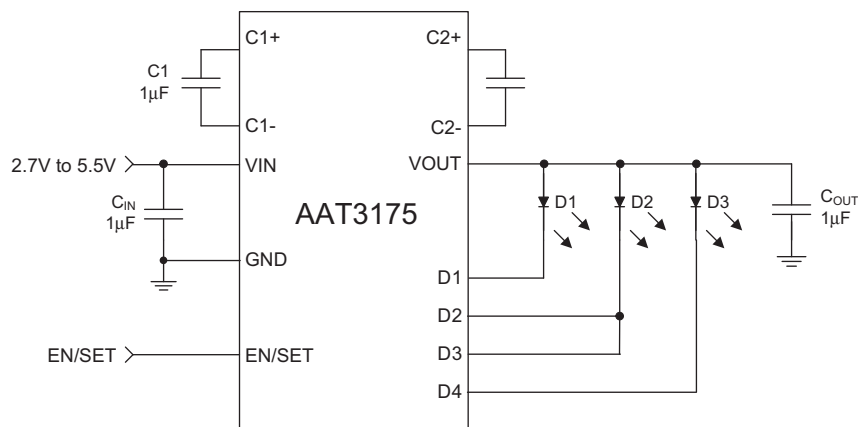

AAT3175**High Efficiency 1X/1.5X/2X Charge Pump for White LED Flash Applications****Pin Descriptions**

Pin #	Symbol	Function
1	D4	Current sink input #4; 100mA max.
2	EN/SET	S ² Cwire serial interface control pin.
3	C1+	Flying capacitor 1 positive terminal. Connect a 1 μ F capacitor between C1+ and C1-.
4	C1-	Flying capacitor 1 negative terminal.
5	VOUT	Charge pump output to drive load circuit. Requires 1 μ F capacitor connected between this pin and ground.
6	C2+	Flying capacitor 2 positive terminal. Connect a 1 μ F capacitor between C2+ and C2-.
7	C2-	Flying capacitor 2 negative terminal.
8	VIN	Input power supply. Requires 1 μ F capacitor connected between this pin and ground.
9	GND	Ground.
10	D1	Current sink input #1; 100mA max.
11	D2	Current sink input #2; 50mA max.
12	D3	Current sink input #3; 50mA max.
EP		Exposed paddle (bottom). Connect to GND directly beneath package.

Pin Configuration

TDFN33-12
(Top View)

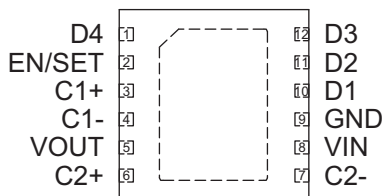

High Efficiency 1X/1.5X/2X Charge Pump for White LED Flash Applications**Absolute Maximum Ratings¹**

Symbol	Description	Value	Units
V_{IN}	Input Voltage	-0.3 to 6	V
$V_{EN/SET}$	EN/SET to GND Voltage	-0.3 to $V_{IN} + 0.3$	V
I_{OUT}^2	Maximum DC Output Current	300	mA
T_J	Operating Junction Temperature Range	-40 to 150	°C
T_{LEAD}	Maximum Soldering Temperature (at leads, 10 sec.)	300	°C

Thermal Information³

Symbol	Description	Value	Units
P_D	Maximum Power Dissipation ⁴	2.0	W
θ_{JA}	Maximum Thermal Resistance	50	°C/W

1. Stresses above those listed in Absolute Maximum Ratings may cause permanent damage to the device. Functional operation at conditions other than the operating conditions specified is not implied. Only one Absolute Maximum Rating should be applied at any one time.

2. Based on long-term current density limitation.

3. Mounted on an FR4 board.

4. Derate 20mW/°C above 25°C.

DATA SHEET

AAT3175

High Efficiency 1X/1.5X/2X Charge Pump for White LED Flash Applications

Electrical Characteristics¹

$C_{IN} = C_{OUT} = C_1 = C_2 = 1.0\mu\text{F}$; $T_A = -40^\circ\text{C}$ to $+85^\circ\text{C}$, unless otherwise noted. Typical values are $T_A = 25^\circ\text{C}$, $V_{IN} = 3.5\text{V}$.

Symbol	Description	Conditions	Min	Typ	Max	Units
Input Power Supply						
V_{IN}	Operation Range		2.7		5.5	V
I_{CC}	Operating Current	1X Mode, $3.0 \leq V_{IN} \leq 5.5$, Active, No Load Current		0.3	1.0	mA
		1.5X Mode, $3.0 \leq V_{IN} \leq 5.5$, Active, No Load Current		1.0	3.0	
		2X Mode, $3.0 \leq V_{IN} \leq 5.5$, Active, No Load Current		2.0	3.7	
I_{SHDN}	Shutdown Current	EN/SET = 0			1.0	μA
I_{DX}	I_{SINK} Average Current Accuracy	D1, D4 Max Setting	90	100	110	mA
		D2, D3 Max Setting	45	50	55	
$I_{(D-Match)}$	Current Matching ²	$V_f:D1:D4 = 3.6\text{V}$, D2 and D3 in Parallel		0.5	5.0	%
V_{TH}	1X to 1.5X or 1.5X to 2X Transition Threshold at Any I_{SINK} Pin			250		mV
Charge Pump Section						
T_{SS}	Soft-Start Time			100		μs
F_{CLK}	Clock Frequency			1000		kHz
EN/SET						
$V_{EN(L)}$	Enable Threshold Low	$V_{IN} = 2.7\text{V}$			0.4	V
$V_{EN(H)}$	Enable Threshold High	$V_{IN} = 5.5\text{V}$	1.4			V
$T_{EN/SET LO}$	EN/SET Low Time		0.3		75	μs
$T_{EN/SET HI MIN}$	Minimum EN/SET High Time			50		ns
$T_{EN/SET HI MAX}$	Maximum EN/SET High Time				75	μs
T_{OFF}	EN/SET Off Timeout				500	μs
T_{LAT}	EN/SET Latch Timeout				500	μs
$I_{EN/SET}$	EN/SET Input Leakage		-1		1	μA

- The AAT3175 is guaranteed to meet performance specifications over the -40°C to $+85^\circ\text{C}$ operating temperature range and is assured by design, characterization, and correlation with statistical process controls.
- Current matching is defined as the deviation of any sink current from the average of all active channels.

AAT3175

High Efficiency 1X/1.5X/2X Charge Pump for White LED Flash Applications

Typical Characteristics

$C_{IN} = C_{OUT} = C_1 = C_2 = 1\mu F$, $T_A = 25^\circ C$, $V_{IN} = 3.5V$, unless otherwise noted.

Efficiency vs. Supply Voltage

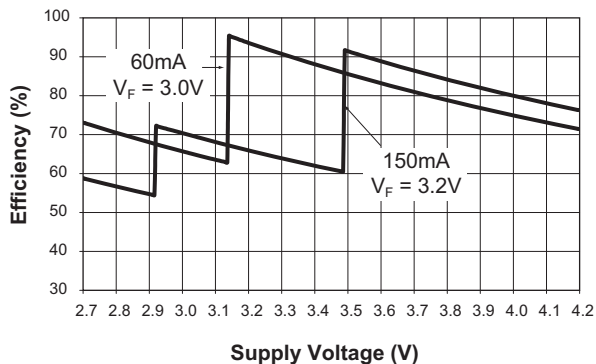

300mA LED Pulse
($V_{IN} = 3.8V$)

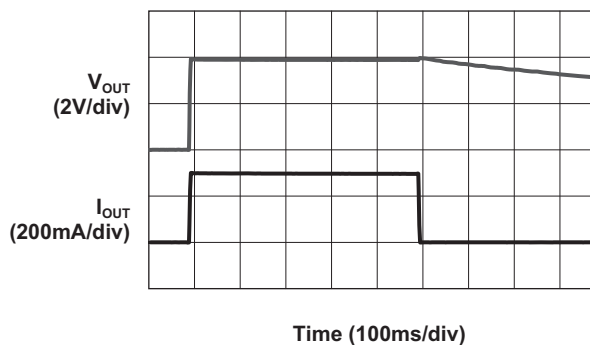

Turn-On to 1X Mode
($V_{IN} = 4.2V$; 300mA Load)

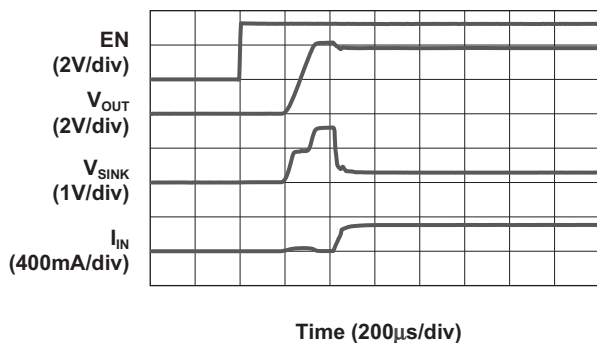

Turn-On to 1.5X Mode
($V_{IN} = 4.0V$; 300mA Load)

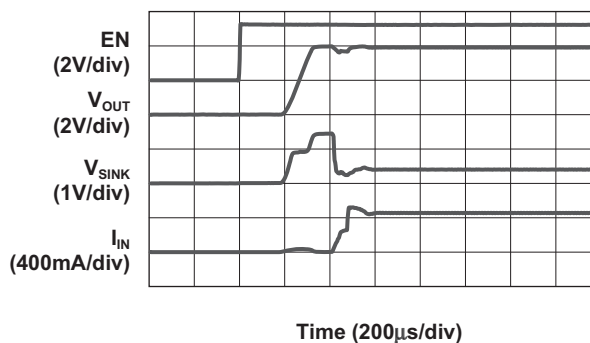

Turn-On to 2X Mode
($V_{IN} = 3.8V$; 300mA Load)

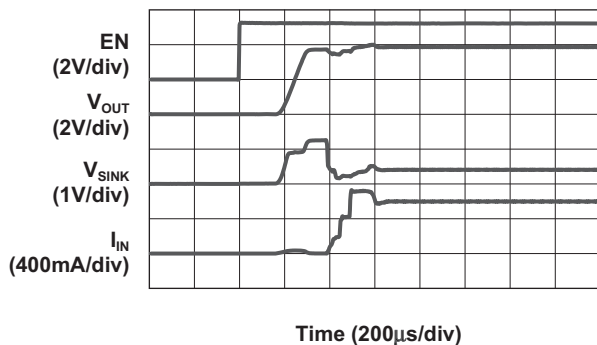

Turn-Off from 1.5X Mode
($V_{IN} = 4.0V$; 300mA Load)

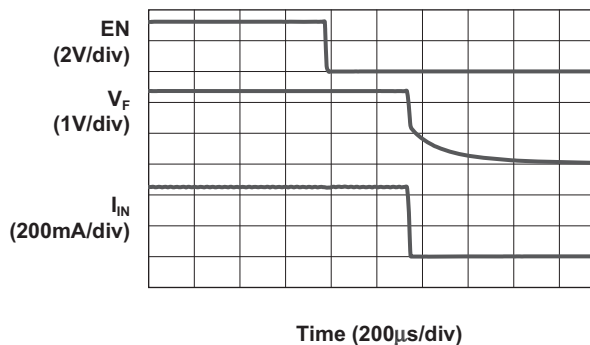

AAT3175

High Efficiency 1X/1.5X/2X Charge Pump for White LED Flash Applications

Typical Characteristics

$C_{IN} = C_{OUT} = C_1 = C_2 = 1\mu F$, $T_A = 25^\circ C$, $V_{IN} = 3.5V$, unless otherwise noted.

Line Response
(1.5X Mode; 150mA Load)

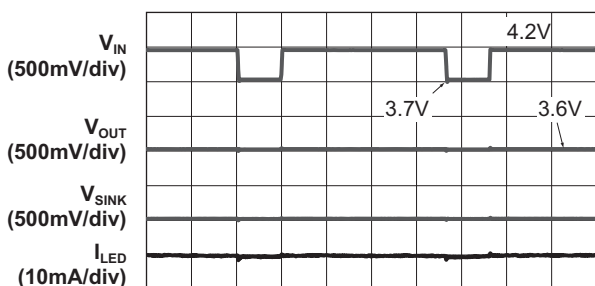

Time (1ms/div)

Load Characteristics
($V_{IN} = 3.5V$; 1.5X Mode; 150mA Load)

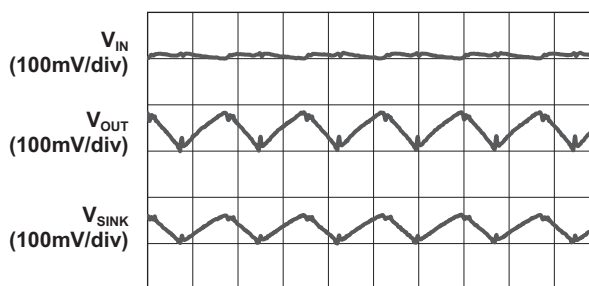

Time (500ns/div)

Load Characteristics
($V_{IN} = 3.0V$; 2X Mode; 150mA Load)

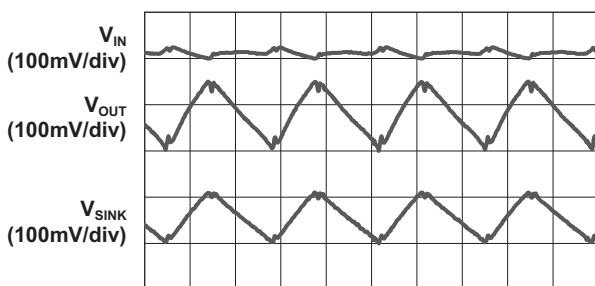

Time (500ns/div)

Input Ripple vs. Input Voltage
(150mA Load)

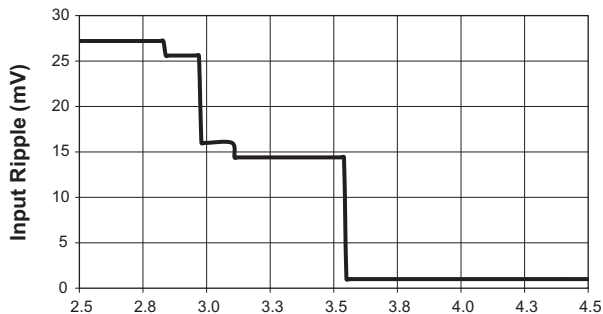

Input Voltage (V)

EN/SET Latch Timeout vs. Input Voltage

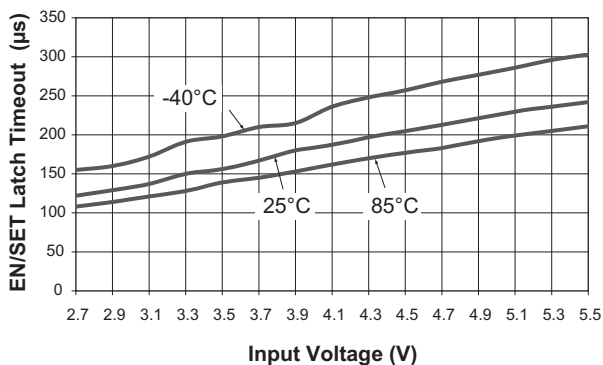

EN/SET Off Timeout vs. Input Voltage

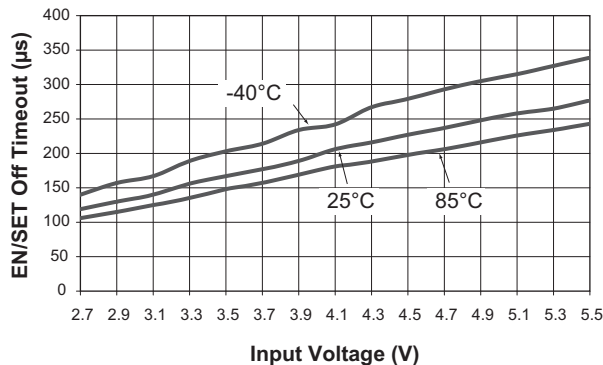

High Efficiency 1X/1.5X/2X Charge Pump for White LED Flash Applications

Typical Characteristics

$C_{IN} = C_{OUT} = C_1 = C_2 = 1\mu F$, $T_A = 25^\circ C$, $V_{IN} = 3.5V$, unless otherwise noted.

Enable Threshold High vs. Input Voltage

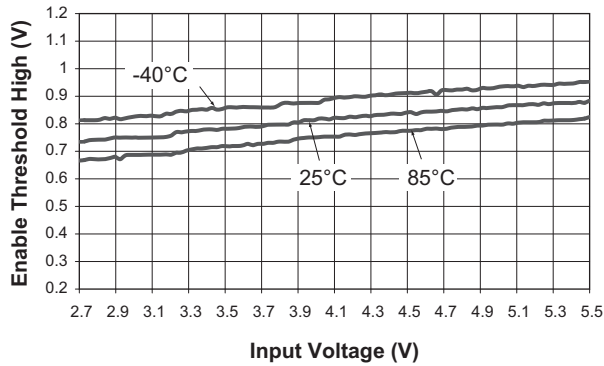

Enable Threshold Low vs. Input Voltage

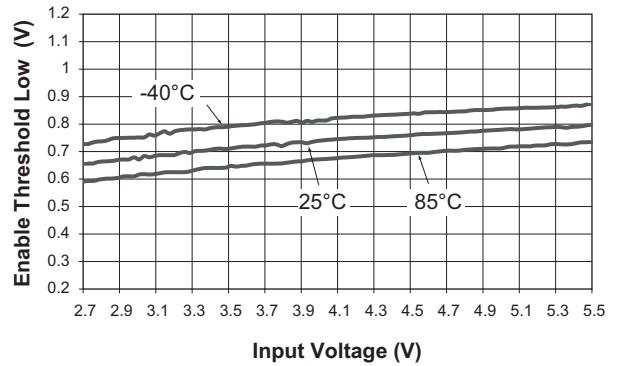

High Efficiency 1X/1.5X/2X Charge Pump for White LED Flash Applications

Functional Block Diagram

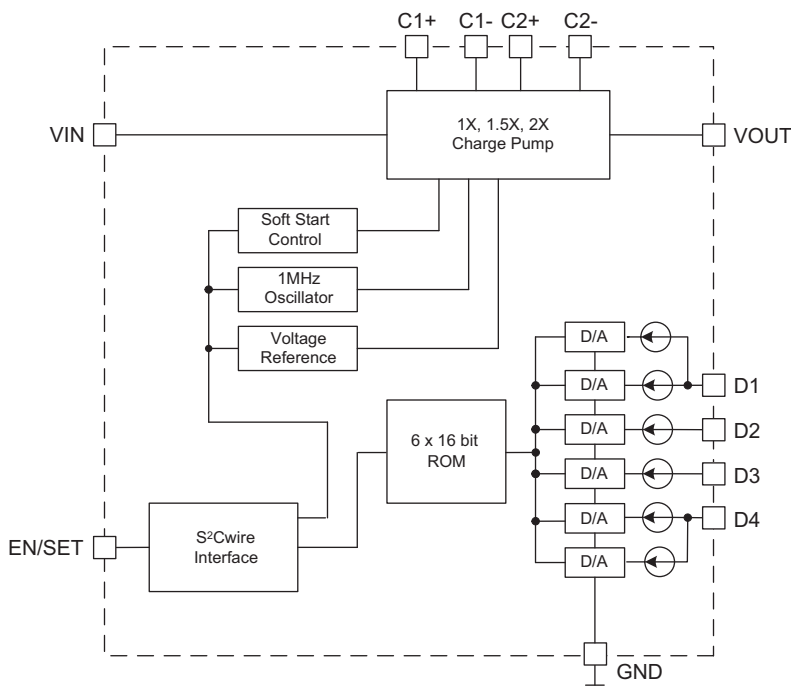

Functional Description

The AAT3175 is a tri-mode load switch (1X) and high efficiency (1.5X or 2X) charge pump device intended for white LED flash applications. To maximize power conversion efficiency, an internal sensing circuit monitors the voltage required on each constant current sink input and sets the load switch and charge pump modes based on the input battery voltage and the current sink input voltage. As the battery discharges over time, the AAT3175 charge pump is enabled when any of the four current sink inputs nears dropout. The charge pump initially starts in 1.5X mode. If the charge pump output droops enough for any current source output to become close to dropout, the charge pump will automatically transition to 2X mode.

The AAT3175 requires only four external components: two 1 μ F ceramic capacitors for the charge pump flying capacitors (C_1 and C_2), one 1 μ F ceramic input capacitor (C_{IN}), and one 0.33 μ F to 1 μ F ceramic charge pump output capacitor (C_{OUT}).

The four constant current sink inputs (D1 to D4) can drive four individual LEDs with a maximum current of 50mA each for D2 and D3. D1 and D4 are driven by two

parallel current sources, resulting in a maximum of 100mA each. Unused sink inputs are connected to V_{OUT} ; otherwise, the part will operate only in 2X charge pump mode. The S²Cwire serial interface enables the AAT3175 and sets the current sink magnitudes. The D1~D4 current configuration is optimized to drive either 2-in-1 LEDs by combining D1/D2, D3/D4, or 3-in-1 LEDs by combining D2/D3.

Constant Current Output Level Settings

The constant current sink levels for D1 to D4 are set via the serial interface according to a logarithmic scale where each code is 1dB lower than the previous code. In this manner, LED brightness appears linear with each increasing code count. Because the inputs D1 to D4 are true independent constant current sinks, the voltage observed on any single given input will be determined by the actual forward voltage (V_F) for the LED being driven.

Since the input current sinks of the AAT3175 are programmable, no PWM (pulse width modulation) or additional control circuitry is needed to control LED brightness. This feature greatly reduces the burden on a microcontroller or system IC to manage LED or display brightness, allowing the user to “set it and forget it.”

High Efficiency 1X/1.5X/2X Charge Pump for White LED Flash Applications

With its high-speed serial interface (1MHz data rate), the input sink current of the AAT3175 can be changed successively to brighten or dim LEDs in smooth transitions (e.g., to fade-out) or in abrupt steps, giving the user complete programmability and real-time control of LED brightness.

S²Cwire Serial Interface

The current level magnitude is controlled by Skyworks' S²Cwire serial interface. The interface records rising edges of the EN/SET pin and decodes them into 16 different states. The 16 current level settings available are indicated in Table 1.

Data	D2, D3 I _{OUT} (mA)	D1, D4 I _{OUT} (mA)
1	50	100
2	44	88
3	40	80
4	36	72
5	32	64
6	28	56
7	25	50
8	22	44
9	20	40
10	17	34
11	16	32
12	14	28
13	13	26
14	11	22
15	10	20
16	0	0

Table 1: Current Level Settings.

The S²Cwire serial interface has flexible timing. Data can be clocked-in at speeds greater than 1MHz, or much slower, such as 15kHz. After data is submitted, EN/SET is held high to latch the data. Once EN/SET has been held in the logic high state for time T_{LAT}, the programmed current becomes active and the internal data register is reset to zero. For subsequent current level programming, the number of rising edges corresponding to the desired code must be entered on the EN/SET pin.

When EN/SET is held low for an amount of time greater than T_{OFF}, the AAT3175 enters into shutdown mode and draws less than 1μA from V_{IN}. The internal data register is reset to zero during shutdown.

Auto-Disable Feature

The AAT3175 is equipped with an auto-disable feature for each LED channel. After the IC is enabled and started up, a test current of 150μA (typical) is forced through each sink channel. The channel will be disabled if the voltage of that particular DX pin does not fall below a certain threshold. This feature is very convenient for disabling an unused channel or during an LED fail-short event.

Thermal Protection

The AAT3175 has a built-in thermal protection circuit that will shut down the charge pump if the die temperature rises above the thermal limit, as is generally the case during a short-circuit of the V_{OUT} pin.

S²Cwire Serial Interface Timing

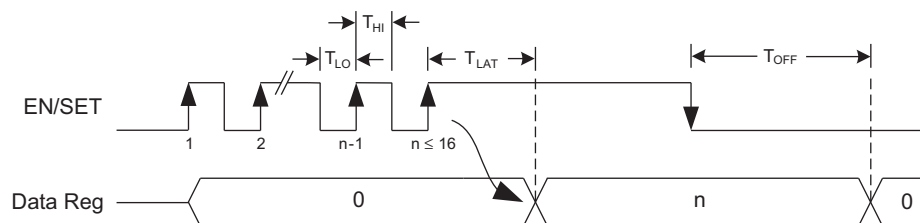

High Efficiency 1X/1.5X/2X Charge Pump for White LED Flash Applications**Applications Information****LED Selection**

Although the AAT3175 is specifically intended for driving white LEDs, the device can also be used to drive most types of LEDs with forward voltage specifications ranging from 2.0V to 4.1V. LED applications may include display backlighting, camera photo-flash applications, color (RGB) LEDs, infrared (IR) diodes for remotes, and other loads benefiting from a controlled output current generated from a varying input voltage. Since the D1 to D4 input current sinks are matched with negligible voltage dependence, the LED brightness will be matched regardless of the specific LED forward voltage (V_F) levels. In some instances (e.g., in high luminous output applications such as photo flash), it may be necessary to drive high- V_F type LEDs. The low dropout current sinks in the AAT3175 make it capable of driving LEDs with forward voltages as high as 4.1V at full current from an input supply as low as 3.5V. Outputs can be paralleled to drive high-current LEDs without complication.

Device Switching Noise Performance

The AAT3175 operates at a fixed frequency of approximately 1MHz to control noise and limit harmonics that can interfere with the RF operation of cellular telephone handsets or other communication devices. Back-injected noise appearing on the input pin of the charge pump is 20mV peak-to-peak, typically ten times less than inductor-based DC/DC boost converter white LED backlight solutions. The AAT3175 soft-start feature prevents noise transient effects associated with inrush currents during start-up of the charge pump circuit.

Capacitor Selection

Careful selection of the four external capacitors C_{IN} , C_1 , C_2 , and C_{OUT} is important because they will affect turn-on time, output ripple, and transient performance. Optimum performance will be obtained when low equivalent series resistance (ESR) ceramic capacitors are used; generally, low ESR may be defined as less than 100m Ω . A value of 1 μ F for all four capacitors is a good starting point when

choosing capacitors. If the LED current sources are only programmed for light current levels, then the capacitor size may be decreased.

Capacitor Characteristics

Ceramic composition capacitors are highly recommended over all other types of capacitors for use with the AAT3175. Ceramic capacitors offer many advantages over their tantalum and aluminum electrolytic counterparts. A ceramic capacitor typically has very low ESR, is lowest cost, has a smaller PCB footprint, and is non-polarized. Low-ESR ceramic capacitors help maximize charge pump transient response. Since ceramic capacitors are non-polarized, they are not prone to incorrect connection damage.

Equivalent Series Resistance

ESR is an important characteristic to consider when selecting a capacitor. ESR is a resistance internal to a capacitor that is caused by the leads, internal connections, size or area, material composition, and ambient temperature. Capacitor ESR is typically measured in milliohms for ceramic capacitors and can range to more than several ohms for tantalum or aluminum electrolytic capacitors.

Ceramic Capacitor Materials

Ceramic capacitors less than 0.1 μ F are typically made from NPO or C0G materials. NPO and C0G materials generally have tight tolerance and are very stable over temperature. Larger capacitor values are usually composed of X7R, X5R, Z5U, or Y5V dielectric materials. Large ceramic capacitors (i.e., greater than 2.2 μ F) are often available in low-cost Y5V and Z5U dielectrics, but capacitors greater than 1 μ F are not typically required for AAT3175 applications.

Capacitor area is another contributor to ESR. Capacitors that are physically large will have a lower ESR when compared to a smaller capacitor made of equivalent material. These larger devices can improve circuit transient response when compared to an equal value capacitor in a smaller package size.

High Efficiency 1X/1.5X/2X Charge Pump for White LED Flash Applications

Ordering Information

Package	Marking ¹	Part Number (Tape and Reel) ²
TDFN33-12	QAXYY	AAT3175IWP-T1



Skyworks Green™ products are compliant with all applicable legislation and are halogen-free. For additional information, refer to *Skyworks Definition of Green™*, document number SQ04-0074.

Package Information

TDFN33-12³

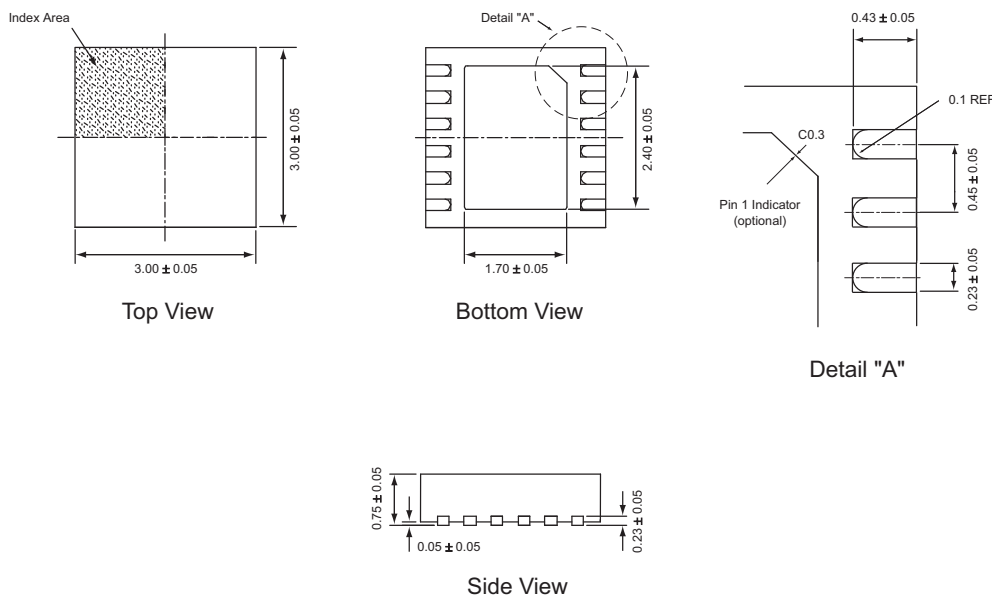

All dimensions in millimeters.

1. XYY = assembly and date code.
2. Sample stock is generally held on part numbers listed in **BOLD**.
3. The leadless package family, which includes QFN, TQFN, DFN, TDFN and STDFN, has exposed copper (unplated) at the end of the lead terminals due to the manufacturing process. A solder fillet at the exposed copper edge cannot be guaranteed and is not required to ensure a proper bottom solder connection.

Copyright © 2012 Skyworks Solutions, Inc. All Rights Reserved.

Information in this document is provided in connection with Skyworks Solutions, Inc. ("Skyworks") products or services. These materials, including the information contained herein, are provided by Skyworks as a service to its customers and may be used for informational purposes only by the customer. Skyworks assumes no responsibility for errors or omissions in these materials or the information contained herein. Skyworks may change its documentation, products, services, specifications or product descriptions at any time, without notice. Skyworks makes no commitment to update the materials or information and shall have no responsibility whatsoever for conflicts, incompatibilities, or other difficulties arising from any future changes.

No license, whether express, implied, by estoppel or otherwise, is granted to any intellectual property rights by this document. Skyworks assumes no liability for any materials, products or information provided hereunder, including the sale, distribution, reproduction or use of Skyworks products, information or materials, except as may be provided in Skyworks Terms and Conditions of Sale.

THE MATERIALS, PRODUCTS AND INFORMATION ARE PROVIDED "AS IS" WITHOUT WARRANTY OF ANY KIND, WHETHER EXPRESS, IMPLIED, STATUTORY, OR OTHERWISE, INCLUDING FITNESS FOR A PARTICULAR PURPOSE OR USE, MERCHANTABILITY, PERFORMANCE, QUALITY OR NON-INFRINGEMENT OF ANY INTELLECTUAL PROPERTY RIGHT; ALL SUCH WARRANTIES ARE HEREBY EXPRESSLY DISCLAIMED. SKYWORKS DOES NOT WARRANT THE ACCURACY OR COMPLETENESS OF THE INFORMATION, TEXT, GRAPHICS OR OTHER ITEMS CONTAINED WITHIN THESE MATERIALS. SKYWORKS SHALL NOT BE LIABLE FOR ANY DAMAGES, INCLUDING BUT NOT LIMITED TO ANY SPECIAL, INDIRECT, INCIDENTAL, STATUTORY, OR CONSEQUENTIAL DAMAGES, INCLUDING WITHOUT LIMITATION, LOST REVENUES OR LOST PROFITS THAT MAY RESULT FROM THE USE OF THE MATERIALS OR INFORMATION, WHETHER OR NOT THE RECIPIENT OF MATERIALS HAS BEEN ADVISED OF THE POSSIBILITY OF SUCH DAMAGE.

Skyworks products are not intended for use in medical, lifesaving or life-sustaining applications, or other equipment in which the failure of the Skyworks products could lead to personal injury, death, physical or environmental damage. Skyworks customers using or selling Skyworks products for use in such applications do so at their own risk and agree to fully indemnify Skyworks for any damages resulting from such improper use or sale.

Customers are responsible for their products and applications using Skyworks products, which may deviate from published specifications as a result of design defects, errors, or operation of products outside of published parameters or design specifications. Customers should include design and operating safeguards to minimize these and other risks. Skyworks assumes no liability for applications assistance, customer product design, or damage to any equipment resulting from the use of Skyworks products outside of stated published specifications or parameters.

Skyworks, the Skyworks symbol, and "Breakthrough Simplicity" are trademarks or registered trademarks of Skyworks Solutions, Inc., in the United States and other countries. Third-party brands and names are for identification purposes only, and are the property of their respective owners. Additional information, including relevant terms and conditions, posted at www.skyworksinc.com, are incorporated by reference.