

1.6A Li-Ion/Polymer Battery Charger in a 2.2x2.2 TDFN Package

General Description

The AAT3693 BatteryManager is a highly integrated single-cell lithium-ion/polymer (Li-Ion) battery charger which operates from a USB port, or an AC adapter input up to 7.5V input voltage. The AAT3693 precisely regulates battery charge voltage and current for 4.2V Li-Ion battery cells. The battery charging current can be set by an external resistor up to 1.6A. Digital Thermal Loop Control maintains the maximum possible battery charging current for the given set of input to output power dissipation and ambient temperature conditions.

Battery charge state is continuously monitored for fault conditions. In the event of an over-current, over-voltage, short-circuit, or over-temperature condition, the device will shut down automatically, thus protecting the charging device, control system, and the battery under charge. A status monitor output pin is provided to indicate the battery charge status by directly driving an external LED. An open-drain power source detection output is provided to report the power supply status. With the "No-Battery Detection" circuit integrated, the status LEDs indicate that the battery is not present or not properly installed.

The AAT3693 is available in the Pb-free, thermally enhanced, space-saving 2.2x2.2mm 10-pin TDFN packages and is specified for operation over the -40°C to +85°C temperature range.

Features

- USB or AC Adapter System Power Charger
- Programmable from 100mA to 1.6A max
- 4.0V ~ 7.5V Input Voltage Range
- High Level of Integration with Internal:
 - Charging Device
 - Reverse Blocking Diode
 - Current Sensing
- Digitized Thermal Regulation
- Charge Current Programming (ISET)
- Charge Termination Current Programming (TERM)
- Charge Timer (CT)
- Battery Temperature Sensing (TS)
- No-Battery Detection
- TS Pin Open Detection
- Automatic Recharge Sequencing
- Full Battery Charge Auto Turn Off/Sleep Mode/Charge Termination
- Shutdown Current < 6µA
- Automatic Trickle Charge for Battery Preconditioning
- Over-Voltage and Over-Current Protection
- Emergency Thermal Protection
- Power On Reset and Soft Start
- 2.2x2.2 TDFN Package

Applications

- Bluetooth™ Headsets
- Cell Phones
- Digital Still Cameras
- MP3 Players
- Personal Data Assistants (PDAs)
- Other Li-Ion Battery Powered Devices

Typical Application

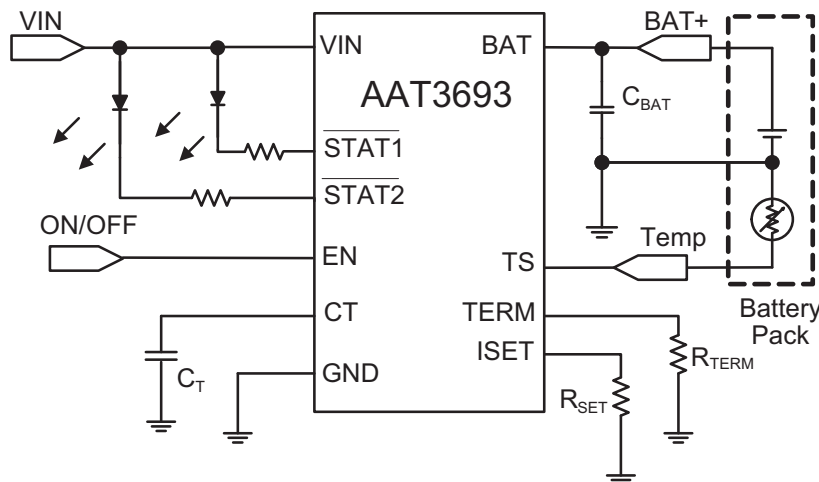

1.6A Li-Ion/Polymer Battery Charger in a 2.2x2.2 TDFN Package

Pin Descriptions

Pin #	Name	Type	Function
1	VIN	I	Input from USB port/adapter connector.
2	STAT1	O	Charge status pin, open-drain.
3	STAT2	O	Charge status pin, open-drain.
4	EN	I	Active high enable pin (with internal pull-down).
5	GND	I/O	Connect to power ground.
6	CT	I	Charge timer programming input pin (no timer if grounded).
7	ISET	I	Charge current programming input pin.
8	TERM	I	Charge termination current programming input pin (internal default 10% termination current if TERM is open).
9	TS	I/O	Battery temperature sense pin.
10	BAT	O	Connect to lithium-ion battery.
EP	EP		Exposed paddle (bottom): Connect to ground as closely as possible to the device.

Pin Configuration

**TDFN-10
(Top View)**

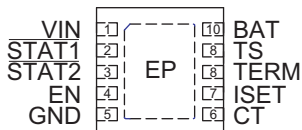

1.6A Li-Ion/Polymer Battery Charger in a 2.2x2.2 TDFN Package**Absolute Maximum Ratings¹**

Symbol	Description	Value	Units
V _{IN}	IN continuous	-0.3 to 8.0	V
V _N	BAT, STAT1, STAT2, EN, ISET, TS	-0.3 to V _{IN} + 0.3	V
T _J	Junction Temperature Range	-40 to 150	°C
T _{OP}	Operating Temperature Range	-40 to 85	°C
T _{LEAD}	Maximum Soldering Temperature (at Leads)	300	°C

Thermal Information²

Symbol	Description	Value	Units
θ _{JA}	Maximum Thermal Resistance	50	°C/W
P _D	Maximum Power Dissipation (TDFN2.2x2.2; T _A = 25°C)	2	W

1. Stresses above those listed in Absolute Maximum Ratings may cause permanent damage to the device. Functional operation at conditions other than the operating conditions specified is not implied. Only one Absolute Maximum Rating should be applied at any one time.
2. Mounted on a FR4 board.

1.6A Li-Ion/Polymer Battery Charger in a 2.2x2.2 TDFN Package

Electrical Characteristics

$V_{IN} = 5V$, $T_A = -40^{\circ}C$ to $+85^{\circ}C$, $R_{SET} = 1.47k\Omega$, $R_{TERM} = OPEN$; unless otherwise noted, typical values are at $T_A = 25^{\circ}C$.

Symbol	Description	Conditions	Min	Typ	Max	Units
Operation						
V_{IN}	Input Voltage Range		4.0		7.5	V
V_{UVLO}	Under-Voltage Lockout Threshold	Rising Edge	3		4	V
	UVLO Hysteresis			150		mV
I_{OP}	Operating Current	Charge Current = 100mA		0.3	1	mA
I_{SLEEP}	Sleep Mode Current	$V_{BAT} = 4.25V$ or $EN = GND$		0.4	1	μA
$I_{LEAKAGE}$	Leakage Current from BAT Pin	$V_{BAT} = 4V$, IN Pin Open		0.4	2	μA
Voltage Regulation						
$V_{CO(REG)}$	Constant Output Voltage		4.158	4.20	4.242	V
$\Delta V_{CO}/V_{CO}$	Constant Output Voltage Tolerance			0.5		%
V_{MIN}	Preconditioning Voltage Threshold	(Option available for no trickle charge)	2.5	2.6	2.9	V
V_{RCH}	Battery Recharge Voltage Threshold			$V_{BAT_REG} - 0.1$		V
Current Regulation						
$I_{CC(RANGE)}$	Charge Current Programmable Range		100		1600	mA
$\Delta I_{CC}/I_{CC}$	Constant-Current Mode Charge Current	$V_{BAT} = 3.6V$	-10		+10	%
V_{ISET}	ISET Pin Voltage			2		V
K_{I_SET}	Charge Current Set Factor: I_{CH_CC}/I_{ISET}	Constant Current Mode, $V_{BAT} = 3.6V$		800		
V_{TERM}	TERM Pin Voltage	$R_{TERM} = 13.3k\Omega$		2		V
I_{CH_TRK}/I_{CC}	Trickle Charge Current		5	10	15	% I_{CH_CC}
I_{CH_TERM}/I_{CC}	Charge Termination Threshold Current	TERM pin open	5	10	15	% I_{CH_CC}
		$R_{TERM} = 13.3k\Omega$, $I_{CC} \geq 800mA$	8	10	12	%
Charging Devices						
$R_{DS(ON)}$	Charging Transistor On-Resistance	$V_{IN} = 4.6V$, $V_{BAT} = 4.0V$, Charge Current = 1A			0.6	Ω
Logic Control / Protection						
$V_{EN(H)}$	Input High Threshold		1.6			V
$V_{EN(L)}$	Input Low Threshold				0.4	V
V_{STAT}	STAT PIN Output Voltage	STAT pin sinks 4mA			0.4	V
I_{STAT}	STAT Pin Current Sink Capability				8	mA
V_{OVP}	Over-Voltage Protection Threshold			4.4		V
I_{OCP}	Over-Current Protection Threshold	(In Constant Voltage Mode)		105		% I_{CH_CC}
T_{SNOBAT}	TS Voltage Range for No Battery Indication		$V_{IN} - 50mV$			V
Option for AA, AC, AI, AK¹						
T_K	Trickle Time Out	$C_{CT} = 0.1\mu F$, $V_{IN} = 5V$		25		Minutes
$T_C + T_V$	CC + CV Mode Time Out	$C_{CT} = 0.1\mu F$, $V_{IN} = 5V$		3		Hours
Option for AB, AD, AJ, AK¹						
T_K	No Trickle Charge			0		Minutes
$T_C + T_V$	CC + CV Mode Time Out	$C_{CT} = 0.1\mu F$, $V_{IN} = 5V$		3		Hours
Option for AE, AG¹						
T_K	Trickle Time Out	$C_{CT} = 0.1\mu F$, $V_{IN} = 5V$		25		Minutes
T_C	CC Mode Time Out	$C_{CT} = 0.1\mu F$, $V_{IN} = 5V$		1		Hours
T_V	CV Mode Time Out	$C_{CT} = 0.1\mu F$, $V_{IN} = 5V$		2		Hours

1. Only options AA, AB, AI and AJ have been released.

1.6A Li-Ion/Polymer Battery Charger in a 2.2x2.2 TDFN Package

Electrical Characteristics (continued)

$V_{IN} = 5V$, $T_A = -40^{\circ}C$ to $+85^{\circ}C$, $R_{SET} = 1.47K\Omega$, $R_{TERM} = OPEN$; unless otherwise noted, typical values are at $T_A = 25^{\circ}C$.

Symbol	Description	Conditions	Min	Typ	Max	Units
Option for AF, AH¹						
T_K	No Trickle Charge			0		Minutes
T_C	CC Mode Time Out	$C_{CT} = 0.1\mu F$, $V_{IN} = 5V$		1		Hours
T_V	CV Mode Time Out	$C_{CT} = 0.1\mu F$, $V_{IN} = 5V$		2		Hours
Option for AC, AD, AG, AH, AK, AL, BO, BP¹						
I_{TS}	Current Source from TS Pin			75		μA
V_{TS1}	High Temperature Threshold	Threshold		331		mV
		Hysteresis		25		mV
V_{TS2}	Low Temperature Threshold	Threshold		2.39		V
		Hysteresis		25		mV
Option for AA, AB, AE, AF, AI, AJ, BM, BN¹						
V_{TS1}	High Temperature Threshold		29.1	30	30.9	$\%V_{IN}$
V_{TS2}	Low Temperature Threshold		58.2	60	61.8	$\%V_{IN}$
T_{LOOP_IN}	Thermal Loop Entering Threshold			115		$^{\circ}C$
T_{LOOP_OUT}	Thermal Loop Exiting Threshold			85		$^{\circ}C$
T_{REG}	Thermal Loop Regulation			100		$^{\circ}C$
T_{SHDN}	Chip Thermal Shutdown Temperature	Threshold		140		$^{\circ}C$
		Hysteresis		15		$^{\circ}C$

1. Only options AA, AB, AI and AJ have been released.

1.6A Li-Ion/Polymer Battery Charger in a 2.2x2.2 TDFN Package

Typical Characteristics

Charging Current vs. Set Resistor Values

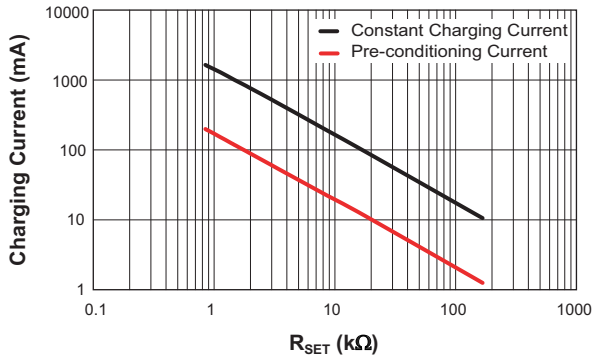

Charging Current vs. Battery Voltage

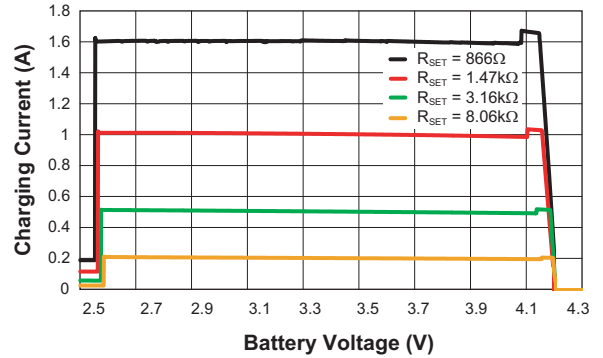

Battery Charger Constant Output Voltage Accuracy vs. Input Voltage (Battery Voltage = 4.2V)

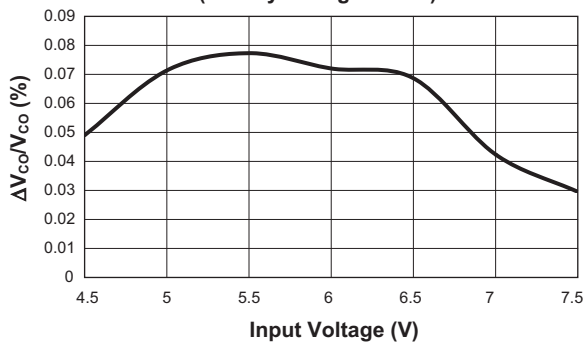

Battery Charger Constant Output Voltage vs. Temperature

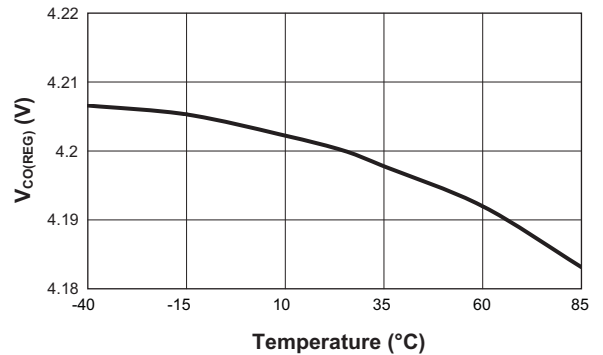

Preconditioning Charge Current vs. Temperature (R_{SET} = 866Ω)

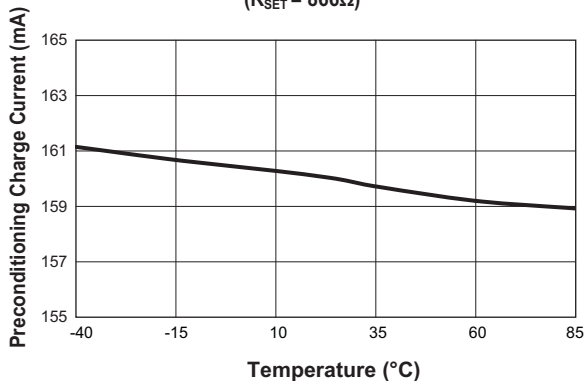

Preconditioning Voltage Threshold vs. Temperature

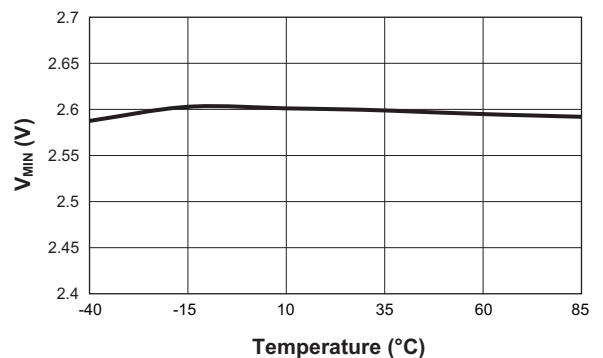

1.6A Li-Ion/Polymer Battery Charger in a 2.2x2.2 TDFN Package

Typical Characteristics

Preconditioning Charge Current vs. Input Voltage

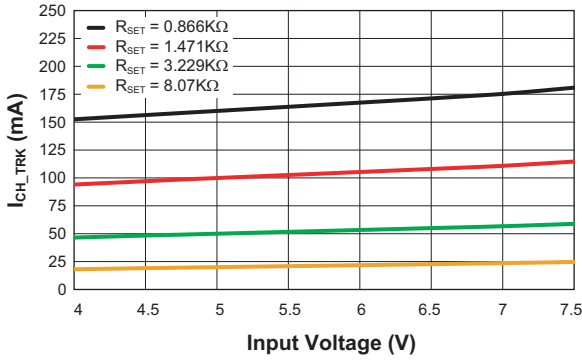

Battery Recharge Voltage Threshold vs. Temperature

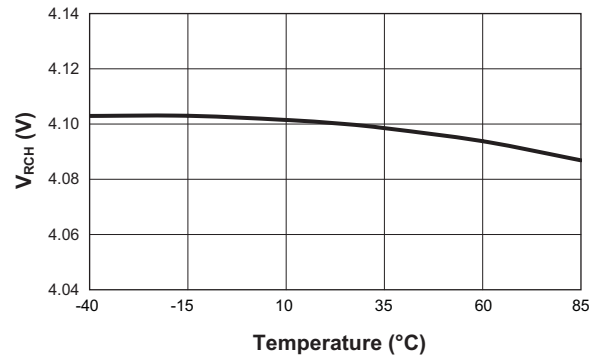

Constant Charging Current vs. Input Voltage
($R_{SET} = 0.866k\Omega$)

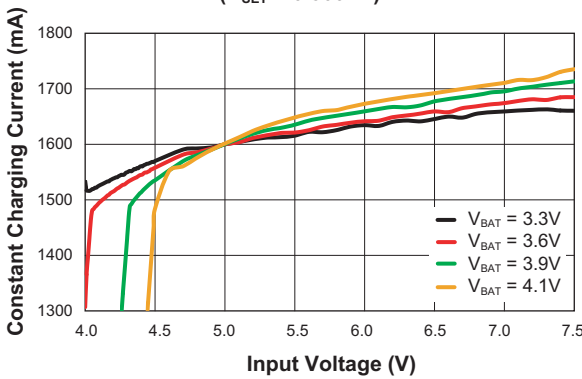

Current Source at the TS Pin vs. Temperature
(for Option AC, AD, AG, AH, AK, AL, BO, BP)

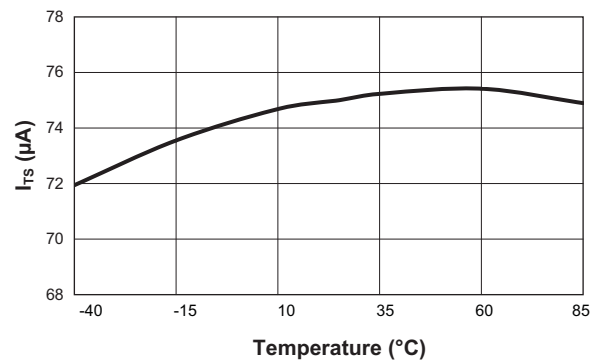

Low Temperature Threshold vs. Temperature
(For Option AC, AD, AG, AH, AK, AL, BO, BP)

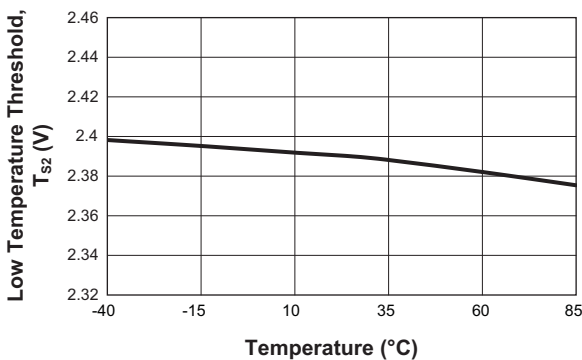

High Temperature Threshold vs. Temperature
(For Option AC, AD, AG, AH, AK, AL, BO, BP)

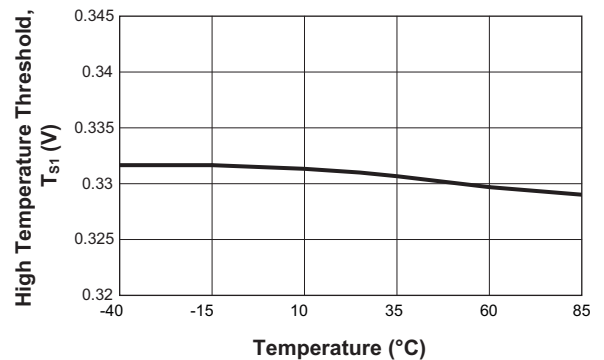

1.6A Li-Ion/Polymer Battery Charger in a 2.2x2.2 TDFN Package

Typical Characteristics

Low Temperature Threshold vs. Temperature
(For Option AA, AB, AE, AF, AI, AJ, BM, BN; $V_{IN} = 5V$)

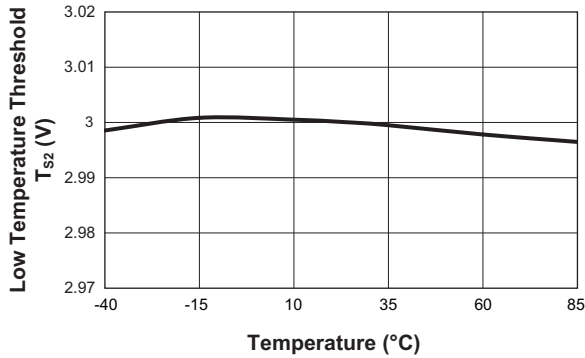

High Temperature Threshold vs. Temperature
(For Option AA, AB, AE, AF, AI, AJ, BM, BN; $V_{IN} = 5V$)

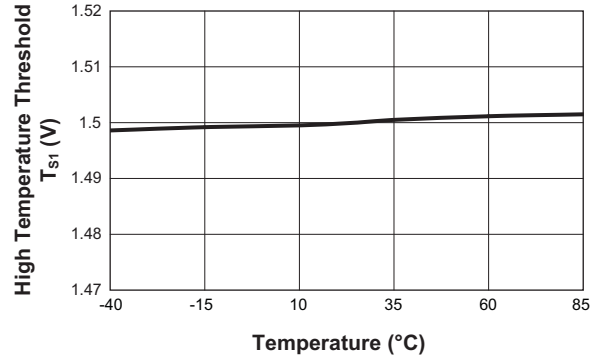

Operating Current vs. I_{SET} Resistor

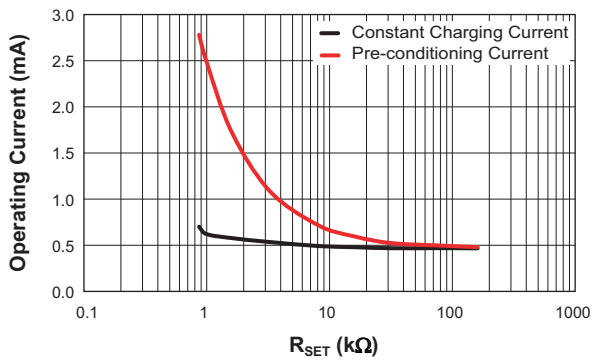

Shutdown Current vs. Input Voltage

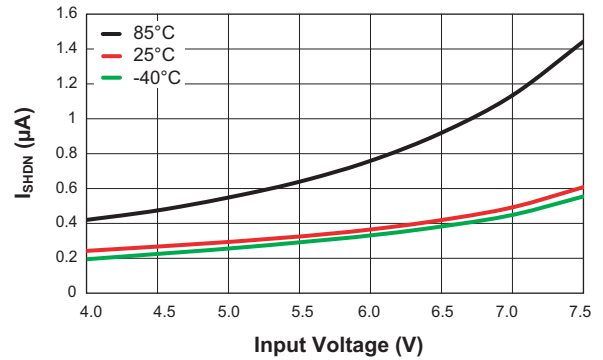

Counter Timeout vs. Temperature
($C_T = 0.1\mu F$)

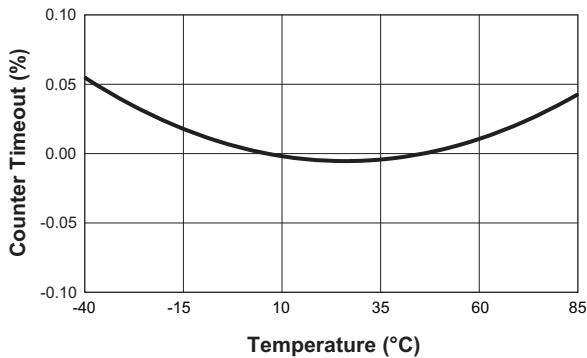

CT Pin Capacitance vs. Counter Timeout

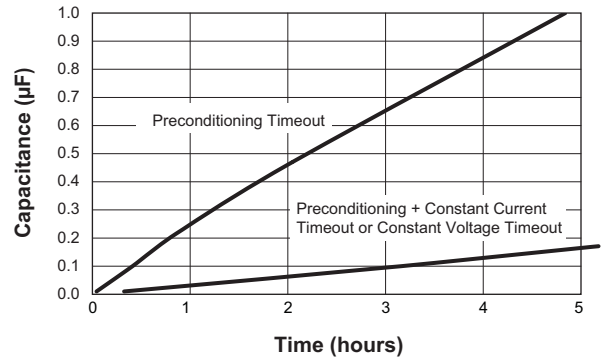

1.6A Li-Ion/Polymer Battery Charger in a 2.2x2.2 TDFN Package

Typical Characteristics

Termination Current to Constant Current Ratio (%) vs. Termination Resistance

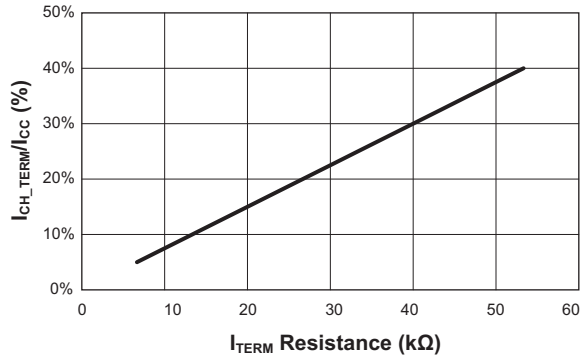

Charging Transistor On Resistance vs. Input Voltage

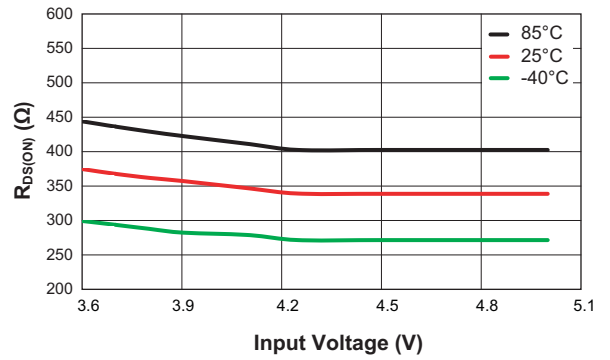

Input High Threshold vs. Input Voltage

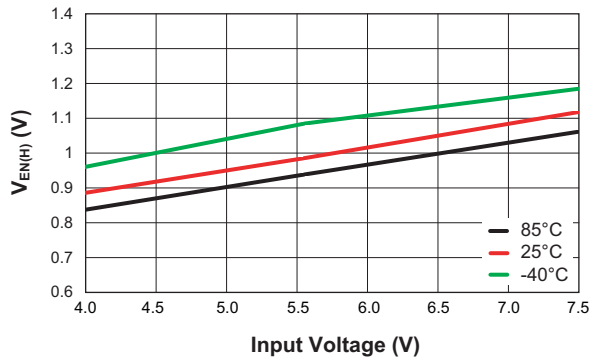

Input Low Threshold vs. Input Voltage

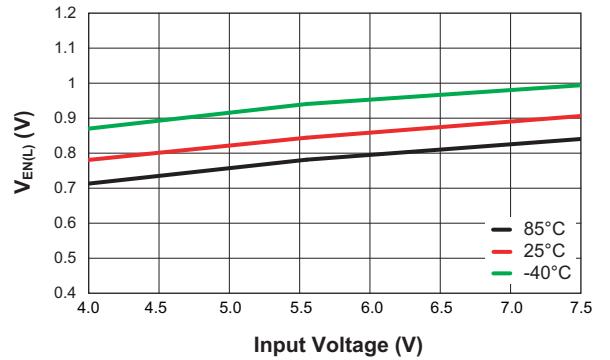

1.6A Li-Ion/Polymer Battery Charger in a 2.2x2.2 TDFN Package

Functional Block Diagram

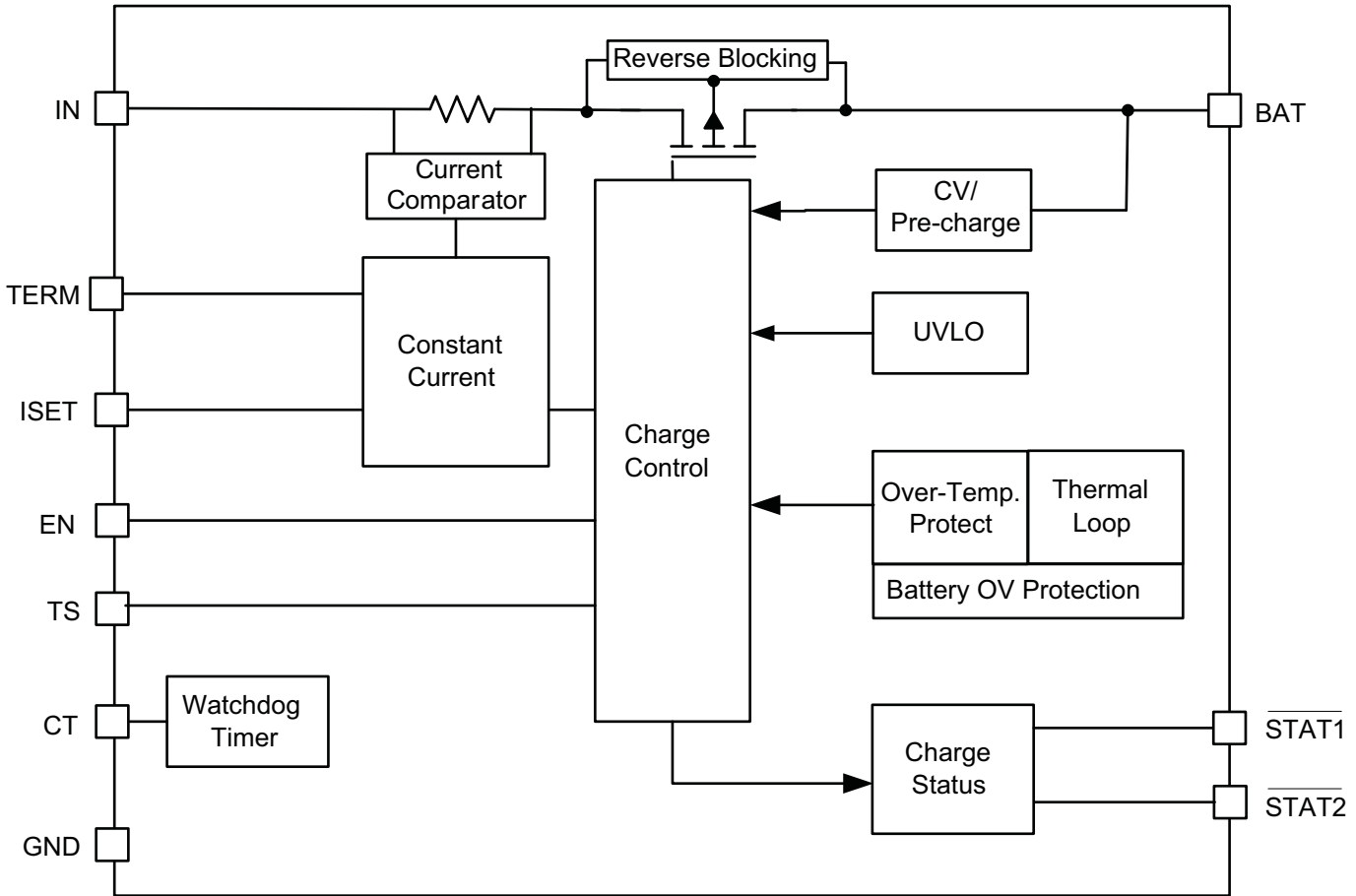

Functional Description

The AAT3693 is a high performance battery charger designed to charge single-cell lithium-ion or lithium-polymer batteries with up to 1.6A of current from an external power source. It is a stand-alone charging solution, with just one external component required for complete functionality.

The AAT3693 precisely regulates battery charge voltage and current for 4.2V lithium-ion/polymer battery cells with constant current level being programmed up to 1.6A for rapid charging applications. The charge termination current can be programmed by an external resistor.

The AAT3693 is rated for operation from -40°C to +85°C. In the event of operating ambient temperatures exceeding the power dissipation abilities of the device

package for a given constant current charge level, the charge control will enter into thermal limit.

The AAT3693 provides two status monitor output pins (STAT1 and STAT2) which directly drive two external LEDs to indicate the battery charging state. With no-battery detection and status indication, the user can be notified if battery is not inserted properly.

Device junction temperature and charge state are fully monitored for fault conditions. In the event of an over-voltage or over-temperature failure, the device will automatically shut down, protecting the charging device, control system, and the battery under charge.

During battery charging, the device temperature will rise. In some cases with adapter charging, the power dissipation in the device may cause the junction temperature to rise closer to its thermal shutdown threshold.

1.6A Li-Ion/Polymer Battery Charger in a 2.2x2.2 TDFN Package

In the event of an internal over-temperature condition caused by excessive ambient operating temperature or excessive power dissipation condition, the AAT3693 enables a digitally controlled thermal loop system that will reduce the charging current to prevent the device from thermal shutdown. The digital thermal loop will maintain the maximum possible battery charging current for the given set of input to output power dissipation and ambient temperature conditions.

The digital thermal loop control is dynamic in the sense that it will continue to adjust the battery charging current as operating conditions change.

The digital thermal loop will reset and resume normal operation when the power dissipation or over temperature conditions are removed.

Charging Operation

Figure 1 illustrates the entire battery charging profile or operation, which consists of four phases:

1. Preconditioning (Trickle) Charge
2. Constant Current Charge
3. Constant Voltage Charge
4. Automatic Recharge

Battery Preconditioning

Battery charging commences only after the AAT3693 checks several conditions in order to maintain a safe charging environment. The input supply must be above the minimum operating voltage (V_{UVLO}) and the enable pin must be high.

When the battery is connected to the BAT pin, the AAT3693 checks the condition of the battery and determines which charging mode to apply. If the battery voltage is below the preconditioning voltage threshold, V_{MIN} , then the AAT3693 begins preconditioning the battery cell (trickle charging) by charging at 10% of the programmed constant current. For example, if the programmed current is 500mA, then the preconditioning mode (trickle charge) current is 50mA. Battery cell preconditioning (trickle charging) is a safety precaution for deeply discharged cells and will also reduce the power dissipation in the internal series pass MOSFET when the input-output voltage differential is at the greatest potential.

Constant Current Charging

Battery cell preconditioning continues until the battery voltage reaches the preconditioning voltage threshold, V_{MIN} . At this point, the AAT3693 begins constant current charging. The current level for this mode is programmed using a single resistor from the ISET pin to ground. Programmed current can be set from a minimum of 100mA up to a maximum of 1.6A

Constant Voltage Charging

Constant current charging will continue until the battery voltage reaches the constant output voltage (end of charge) voltage regulation point, $V_{CO(REG)}$. When the battery voltage reaches $V_{CO(REG)}$, the AAT3693 will transition to constant voltage mode. The regulation voltage is factory programmed to a nominal 4.2V and will continue charging until the charge termination current is reached.

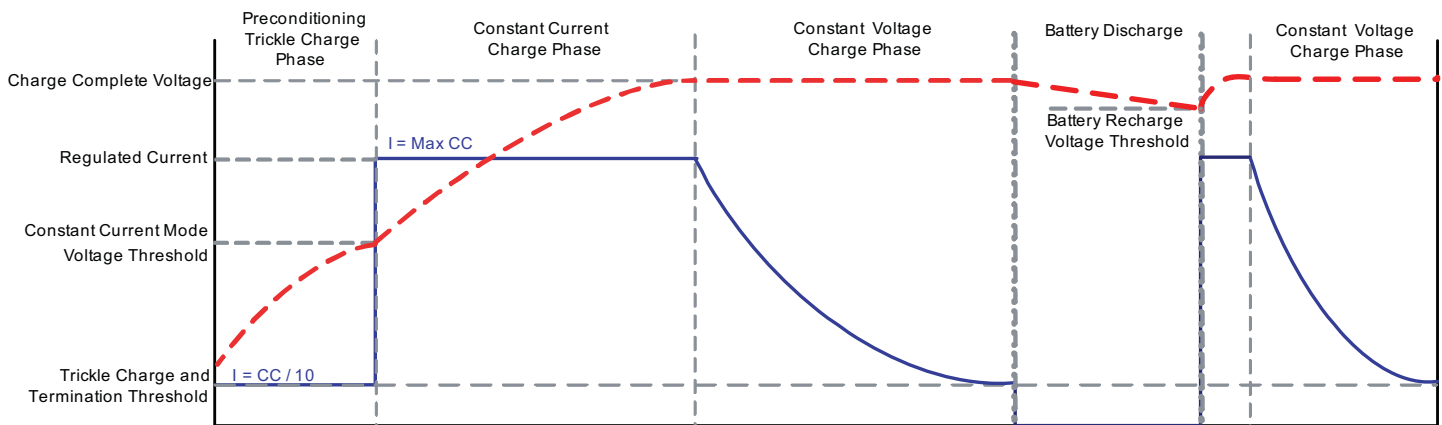
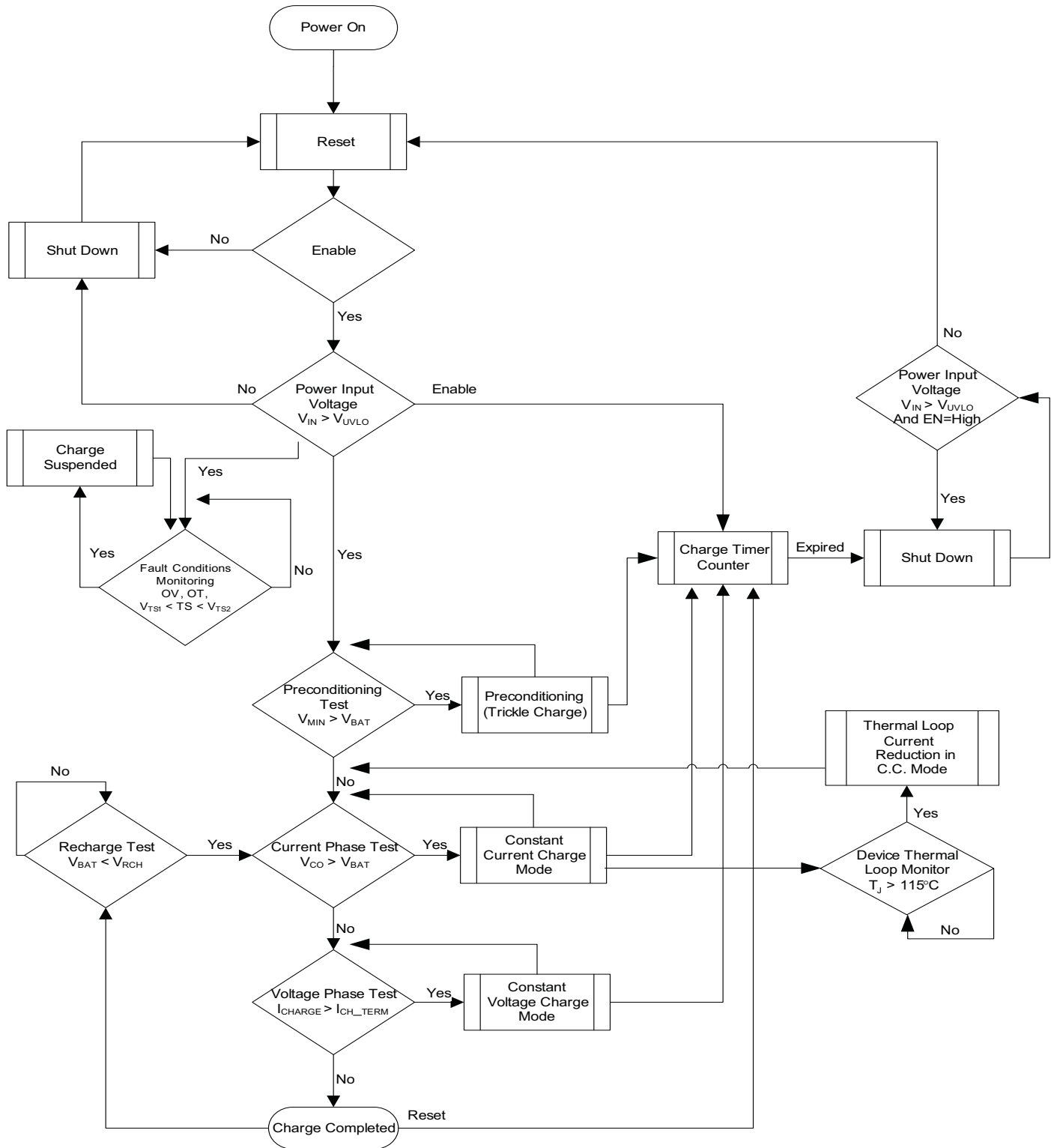

Figure 1: Current vs. Voltage Profile During Charging Phases.

1.6A Li-Ion/Polymer Battery Charger in a 2.2x2.2 TDFN Package

System Operation Flowchart



1.6A Li-Ion/Polymer Battery Charger in a 2.2x2.2 TDFN Package

Application Information

Adapter or USB Power Input

Constant current charge levels up to 1.6A may be programmed by the user when powered from a sufficient input power source. The AAT3693 will operate from the adapter input over a 4.0V to 7.5V range. The constant current mode fast charge current for the adapter input is set by the R_{SET} resistor connected between ISET and ground. Refer to Table 1 for recommended R_{SET} values for a desired constant current charge level; values are rounded off to 1% standard resistance values.

Automatic Recharge

The AAT3693 has a UVLO and power on reset feature so that if the input supply to the VIN pin drops below the UVLO threshold, the charger will suspend charging and shut down. When power is reapplied to the IN pin or the UVLO condition recovers, the system charge control will assess the state of charge on the battery cell and will automatically resume charging in the appropriate mode for the condition of the battery.

Enable / Disable

The AAT3693 provides an enable function to control the charger IC on and off. The enable (EN) pin is internally pulled down. When pulled to a logic high level, the AAT3693 is enabled. When left open or pulled to a logic low level, the AAT3693 will be shut down. Charging will be halted regardless of the battery voltage or charging state. When the device is re-enabled, the charge control circuit will automatically reset and resume charging functions with the appropriate charging mode based on the battery charge state and measured cell voltage on the BAT pin.

Programming Charge Current

The constant current mode charge level is user programmed with a set resistor placed between the ISET pin and ground. The accuracy of the constant charge current, as well as the preconditioning trickle charge current, is dominated by the tolerance of the set resistor used. For this reason, a 1% tolerance metal film resistor is recommended for the set resistor function. The constant charge current levels from 100mA to 1.6A may be set by selecting the appropriate resistor value from Table 1.

Constant Charging Current (mA)	Set Resistor Value (k Ω)
100	16.5
200	8.06
300	5.36
400	4.02
500	3.16
600	2.67
700	2.26
800	1.87
900	1.78
1000	1.47
1250	1.18
1600	0.866

Table 1: Constant Charging Current vs. R_{SET} .

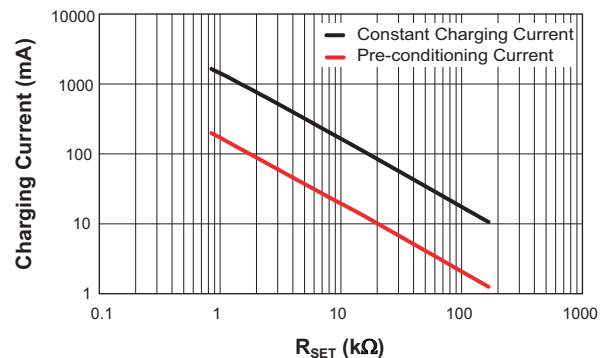

Figure 2: Charging Current vs. R_{SET} Values.

Programmable Charge Termination Current

The AAT3693 provides a user-programmable charge termination current at the end of the charge cycle. When the battery cell voltage as sensed by the BAT pin reaches 4.2V, the charge control will transition from constant current fast charge mode to constant voltage mode. In constant voltage mode, the battery cell voltage will be regulated at 4.2V. The charge current will drop as the battery reaches its full charge capacity. When the charge current drops to the programmed end of charge $V_{CO(REG)}$ current, the charge cycle is complete and the charge controller terminates the charging process.

If the TERM pin is left open, the termination current will set to 10% of the constant charging current as the default value.

1.6A Li-Ion/Polymer Battery Charger in a 2.2x2.2 TDFN Package

The charge termination current I_{CH_TERM} can be programmed by connecting a resistor from TERM to GND. Use the values listed in Table 2 to set the desired charge termination current.

R_{TERM} (k Ω)	I_{CH_TERM} (%)
6.65	5%
13.3	10%
26.7	20%
40.2	30%
53.6	40%

Table 2: Charge Termination Current Programming Resistor Values.

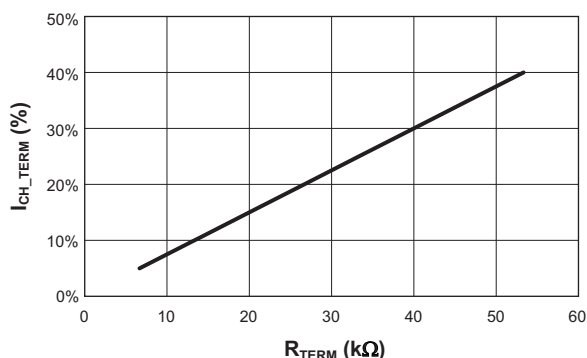

Figure 3: Charge Termination Current vs. R_{TERM} .

If the desired end of charge termination current level is not listed in Table 2, the TERM resistor value may be calculated by the following equation:

$$I_{CH_TERM} = \frac{15\mu A \cdot R_{TERM}}{2V} \cdot I_{CC}$$

When the charge current drops to the programmed charge termination current level in the constant voltage mode, the device terminates charging and goes into a sleep state. The charger will remain in this sleep state until the battery voltage decreases to a level below the battery recharge voltage threshold (V_{RCH}).

In such cases where the AAT3693 input voltage drops, the device will enter sleep state and automatically resume charging once the input supply has recovered from the fault condition. Consuming very low current in sleep state, the AAT3693 minimizes battery drain when it is not charging. This feature is particularly useful in applications where the input supply level may fall below the battery charge or under-voltage lockout level.

Charge Status Outputs

The AAT3693 provides battery charge status via two status pins. These pins are internally connected to an N-channel open-drain MOSFET, which can be used drive external LEDs. The status pins can indicate the following conditions.

Event Description	All Options	Options AA, AB, AE, AF, AI, AJ, BM and BN	Options AC, AD, AG, AH, AK, AL, BO and BP
	STAT1	STAT2 Type 1	STAT2 Type 2
No Battery (with Charge Enabled)	Flash	Flash	Flash
Battery Charging	Low	High	High
Charge Complete	High	Low	High
Fault Condition	High	High	Low

Table 3: LED Status Indicator (STATx Pulled Up to a Voltage Source with Resistors and LED).

Note: Low = LED ON; High = LED OFF

1.6A Li-Ion/Polymer Battery Charger in a 2.2x2.2 TDFN Package

The AAT3693 has a battery fault detector, which, when used in conjunction with a 0.1µF capacitor on the CT pin, outputs a 1Hz signal with 50% duty cycle at the STAT1 pin in the event of a timeout while in the trickle charge mode.

Fault condition can be one of the following:

- Battery over voltage (OV)
- Battery temperature sense hot or cold
- Battery charge timer time-out
- Chip thermal shutdown

Status LED Setup

The LEDs should be biased with as little current as necessary to create reasonable illumination; therefore, a ballast resistor should be placed between the LED cathode and the STAT pin. 2mA should be sufficient to drive most low-cost green or red LEDs. It is not recommended to exceed 8mA for driving an individual status LED. The required ballast resistor values can be estimated using the following formula:

$$R_{\text{BALLAST}} = \frac{(V_{\text{IN}} - V_{\text{FLED}})}{I_{\text{LED}}}$$

Example:

$$R_{\text{BALLAST}} = \frac{(5.0\text{V} - 2.0\text{V})}{2\text{mA}} = 1.5\text{k}\Omega$$

Note: Red LED forward voltage (V_F) is typically 2.0V @ 2mA.

Protection Circuitry

No-Battery Detection

After a battery is inserted and the AAT3693 detects the present of the battery, the regular LED reporting indicates the current charging status after 5-6 flashes. If the battery is not detected, the status LEDs flash at a frequency of 1Hz with ~50% duty cycle ratio continuously on all options (AAT3693 AA, AB, ... , BO and BT), except AI and AJ.

The no-battery detection circuit is not integrated in the AAT3693 AI or AJ. For these two options, the charger IC treats the output ceramic capacitor as a battery. Since the capacitance of the ceramic capacitor is very small, the charge cycle is shortened and the STAT1 LED stays off for a long time and on for a very short time. Therefore, the STAT1 LED appears to always be OFF. In addition, since the ceramic capacitor's discharge cycle is much longer than its charge cycle, the STAT2 LED appears to

remain ON because the brief OFF phase of the cycle is so short that the human eye cannot perceive it.

If the thermal sensing TS pin is open it will be considered as no battery condition. Please refer to the "Battery Temperature Fault Monitoring" section in order to determine the proper biasing for the TS pin.

Programmable Watchdog Timer

The AAT3693 contains a watchdog timing circuit to shut down charging functions in the event of a defective battery cell not accepting a charge over a preset period of time. Typically, a 0.1µF ceramic capacitor is connected between the CT pin and ground. When a 0.1µF ceramic capacitor is used, the device will time out a shutdown condition if the trickle charge mode exceeds 25 minutes. The time out timer will reset at start of the constant current mode setting the time out to 1 hour (default). When the device transitions to the constant voltage mode, the timing counter is reset and will time out after an additional 2 hours if the charge current does not drop to the charge termination level for options AE, AF, AG, AH, BM, BN, BO and BP. For all other options (AA, AB, AC, AD, AI, AJ, AK and AL) the timeout timer does not reset at every charging mode and will time out in 3 hours (default).

Mode	Timer	Time	Units
Trickle Charge (TC) Timeout	Reset	25	Minute
Constant Current (CC) Timeout	Reset	1	Hour
Constant Voltage (CV) Timeout	Reset	2	Hour

Table 4: Watchdog Timer Time-out Options.

Assuming: $C_T = 0.1\mu\text{F}$ and $V_{\text{IN}} = 5.0\text{V}$

The CT pin is driven by a constant current source and will provide a linear response to increases in the timing capacitor value. Thus, if the timing capacitor were to be doubled from the nominal 0.1µF value, the time-out periods would be doubled. If the programmable watchdog timer function is not needed, it can be disabled by connecting the CT pin to ground. The CT pin should not be left floating or un-terminated, as this will cause errors in the internal timing control circuit. The constant current provided to charge the timing capacitor is very small, and this pin is susceptible to noise and changes in capacitance value. Therefore, the timing capacitor should be physically located on the printed circuit board layout as close as possible to the CT pin. Since the accuracy of the internal timer is dominated by the capacitance value, a 10% tolerance or better ceramic capacitor is recommended. Ceramic capacitor materials, such as X7R and X5R types are a good choice for this application.

1.6A Li-Ion/Polymer Battery Charger in a 2.2x2.2 TDFN Package

Battery Over-Voltage Protection

An over-voltage event is defined as a condition where the voltage on the BAT pin exceeds the maximum battery charge voltage and is set by the overvoltage protection threshold (V_{OVP}). If an over-voltage condition occurs, the AAT3693 charge control will shut down the device until the voltage on the BAT pin drops below V_{OVP} . The AAT3693 will resume normal charging operation after the overvoltage condition is removed. During an over-voltage event, the STAT1 LED will report a system fault.

Over-Temperature Shutdown

The AAT3693 has a thermal protection control circuit which will shut down charging functions should the internal die temperature exceed the preset thermal limit threshold. Once the internal die temperature falls below the thermal limit, normal operation will resume the previous charging state.

Battery Temperature Fault Monitoring

In the event of a battery over-temperature condition, the charge control will turn off the internal pass device. The STAT LEDs will also display a system fault. After the system recovers from a temperature fault, the device will resume charging operation.

The AAT3693 checks battery temperature before starting the charge cycle, as well as during all phases of charging. This is accomplished by monitoring the voltage at the TS pin. This system is intended for use with negative temperature coefficient thermistors (NTC) which are typically integrated into the battery package. Most of the commonly used NTC thermistors in battery packs are approximately 10k Ω at room temperature (25°C).

For options AC, AD, AG, AH, AK, AL, BO, and BP, the TS pin has been specifically designed to source 75 μ A of current to the thermistor. The voltage on the TS pin resulting from the resistive load should stay within a window of 331mV to 2.39V. If the battery becomes too hot during charging due to an internal fault or excessive constant charge current, the thermistor will heat up and reduce in value, pulling the TS pin voltage lower than the TS1 threshold, and the AAT3693 will stop charging until the condition is removed, then charging will be resumed. If the use of the TS pin function is not required by the system, it should be terminated to ground using a 10k Ω resistor.

For options AA, AB, AE, AF, AI, AJ, BM, and BN, the internal battery temperature sensing system is comprised of two comparators which establish a voltage window for safe operation. The thresholds for the TS operating window are bounded by the TS1 and TS2 specifications. Referring to the electrical characteristics table in this datasheet, the TS1 threshold = $0.30 \cdot V_{IN}$ and the TS2 threshold = $0.60 \cdot V_{IN}$. If the use of the TS pin function is not required by the system, the TS pin should be connected to input supply V_{IN} .

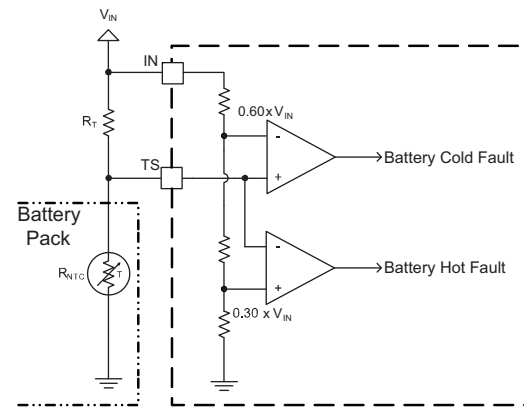

Battery Temperature Sense Circuit
AAT3693-AA, AB, AE, AF, AI, AJ, BM, BN

Figure 4: Battery Temperature Sensing Operation.

Digital Thermal Loop Control

Due to the integrated nature of the linear charging control pass device for the adapter mode, a special thermal loop control system has been employed to maximize charging current under all operation conditions. The thermal management system measures the internal circuit die temperature and reduces the fast charge current when the device exceeds a preset internal temperature control threshold. Once the thermal loop control becomes active, the fast charge current is initially reduced by a factor of 0.44.

The initial thermal loop current can be estimated by the following equation:

$$I_{TLOOP} = I_{CC} \cdot 0.44$$

1.6A Li-Ion/Polymer Battery Charger in a 2.2x2.2 TDFN Package

The thermal loop control re-evaluates the circuit die temperature every three seconds and adjusts the fast charge current back up in small steps to the full fast charge current level or until an equilibrium current is discovered and maximized for the given ambient temperature condition. The thermal loop controls the system charge level; therefore, the AAT3693 will always provide the highest level of constant current in the fast charge mode possible for any given ambient temperature condition

Thermal Considerations

The AAT3693 is offered in the TDFN2.2x2.2-10 package, which can provide up to 2W of power dissipation when properly bonded to a printed circuit board and has a maximum thermal resistance of 50°C/W. Many considerations should be taken into account when designing the printed circuit board layout, as well as the placement of the charger IC package in proximity to other heat generating devices in a given application design. The ambient temperature around the charger IC will also have an effect on the thermal limits of a battery charging application. The maximum limits that can be expected for a given ambient condition can be estimated by the following discussion.

First, the maximum power dissipation for a given situation should be calculated:

$$P_{D(MAX)} = \frac{(T_J - T_A)}{\theta_{JA}}$$

Where:

- $P_{D(MAX)}$ = Maximum Power Dissipation (W)
- θ_{JA} = Package Thermal Resistance (°C/W)
- T_J = Thermal Loop Entering Threshold (°C) [115°C]
- T_A = Ambient Temperature (°C)

Figure 5 shows the relationship between maximum power dissipation and ambient temperature for the AAT3693.

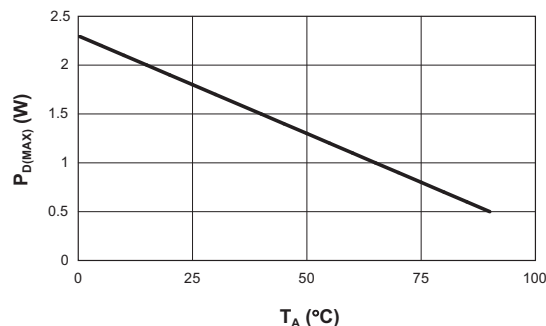

Figure 5: Maximum Power Dissipation Before Entering Thermal Loop.

Next, the power dissipation can be calculated by the following equation:

$$P_D = [(V_{IN} - V_{BAT}) \cdot I_{CC} + (V_{IN} \cdot I_{OP})]$$

Where:

- P_D = Total Power Dissipation by the Device
- V_{IN} = Input Voltage
- V_{BAT} = Battery Voltage as Seen at the BAT Pin
- I_{CH} = Constant Charge Current Programmed for the Application
- I_{OP} = Quiescent Current Consumed by the Charger IC for Normal Operation [0.3mA]

By substitution, we can derive the maximum charge current before reaching the thermal limit condition (thermal loop). The maximum charge current is the key factor when designing battery charger applications.

$$I_{CH(MAX)} = \frac{(P_{D(MAX)} - V_{IN} \cdot I_{OP})}{V_{IN} - V_{BAT}}$$

$$I_{CH(MAX)} = \frac{\frac{(T_{J(MAX)} - T_A)}{\theta_{JA}} - V_{IN} \cdot I_{OP}}{V_{IN} - V_{BAT}}$$

In general, the worst condition is the greatest voltage drop across the charger IC, when battery voltage is charged up to the preconditioning voltage threshold and before entering thermal loop regulation.

1.6A Li-Ion/Polymer Battery Charger in a 2.2x2.2 TDFN Package

Figure 6 shows the maximum charge current at different ambient temperatures.

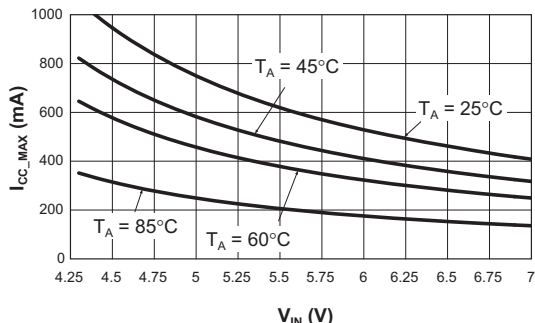

Figure 6: Maximum Charging Current Before the Digital Thermal Loop Becomes Active.

Capacitor Selection

Input Capacitor

In general, it is good design practice to place a decoupling capacitor closer to the IC and between the IN pin and GND.

An input capacitor in the range of 1μF to 22μF is recommended. If the source supply is unregulated, it may be necessary to increase the capacitance to keep the input voltage above the under-voltage lockout threshold during device enable and when battery charging is initiated. If the AAT3693 adapter input is used in a system with an external power supply source, such as a typical AC-to-DC wall adapter, then a C_{IN} capacitor in the range of 10μF

should be used. A larger input capacitor in this application will minimize switching or power transient effects when the power supply is “hot plugged”.

Output Capacitor

The AAT3693 only requires a 1μF ceramic capacitor on the BAT pin to maintain circuit stability. This value should be increased to 10μF or more if the battery connection is made any distance from the charger output. If the AAT3693 is to be used in applications where the battery can be removed from the charger, such as with desktop charging cradles, an output capacitor greater than 10μF may be required to prevent the device from cycling on and off when no battery is present. It is good design practice to place the decoupling capacitor closer to the IC and between the BAT pin and GND.

PCB Layout Considerations

For the best results, it is recommended to physically place the battery pack as close as possible to the AAT3693 BAT pin. To minimize voltage drops on the PCB, keep the high current carrying traces adequately wide. When designing with >500mA charging current system, a multilayer ground plane PCB design is highly recommended. Putting thermal vias on the thermal pad design will effectively transfer heat from the top metal layer of the PCB to the inner or bottom layers. The number of thermal vias will depend on the application and power dissipation. The AAT3693 evaluation board is a layout example for reference.

1.6A Li-Ion/Polymer Battery Charger in a 2.2x2.2 TDFN Package

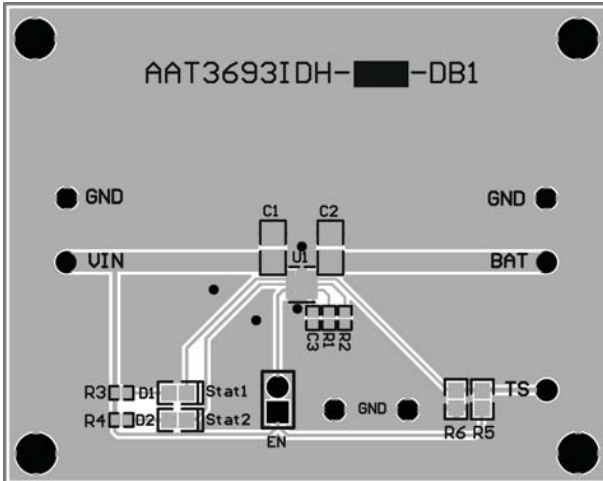

Figure 6: AAT3693 Evaluation Board Top Side Layout.

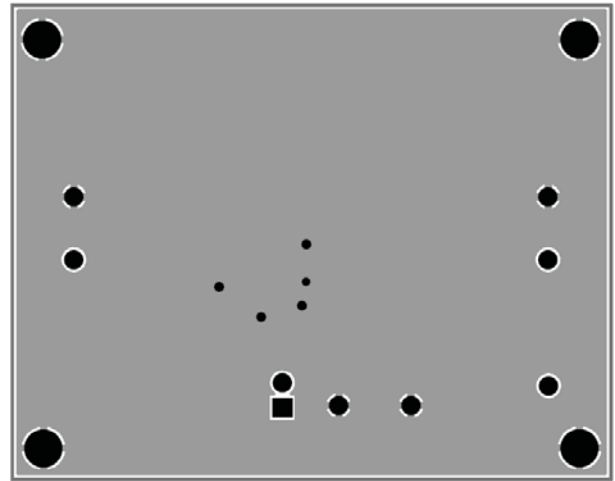

Figure 7: AAT3693 Evaluation Board Middle 1 Layer Layout.

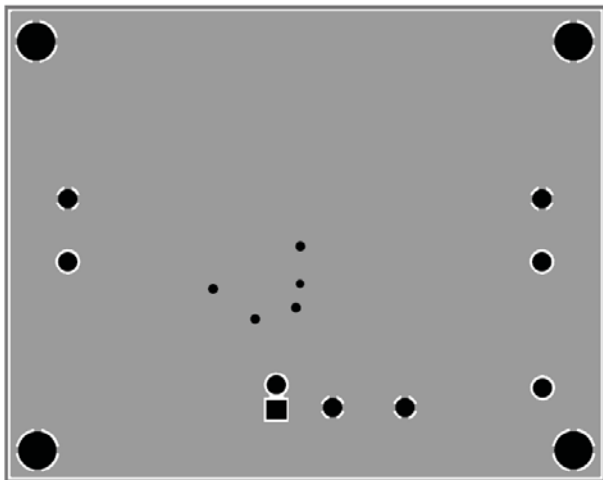

Figure 8: AAT3693 Evaluation Board Middle 2 Layer Layout.

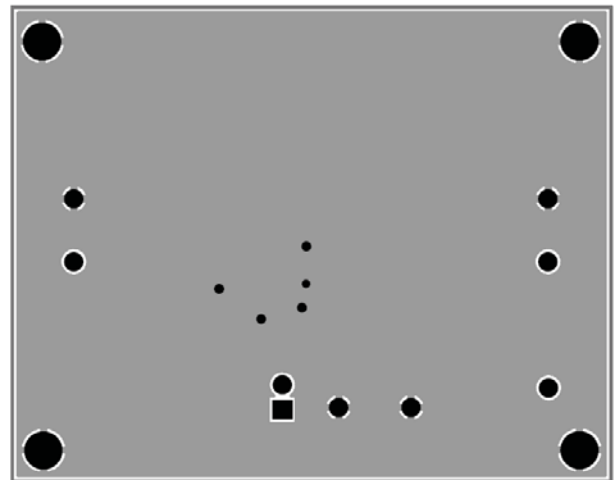
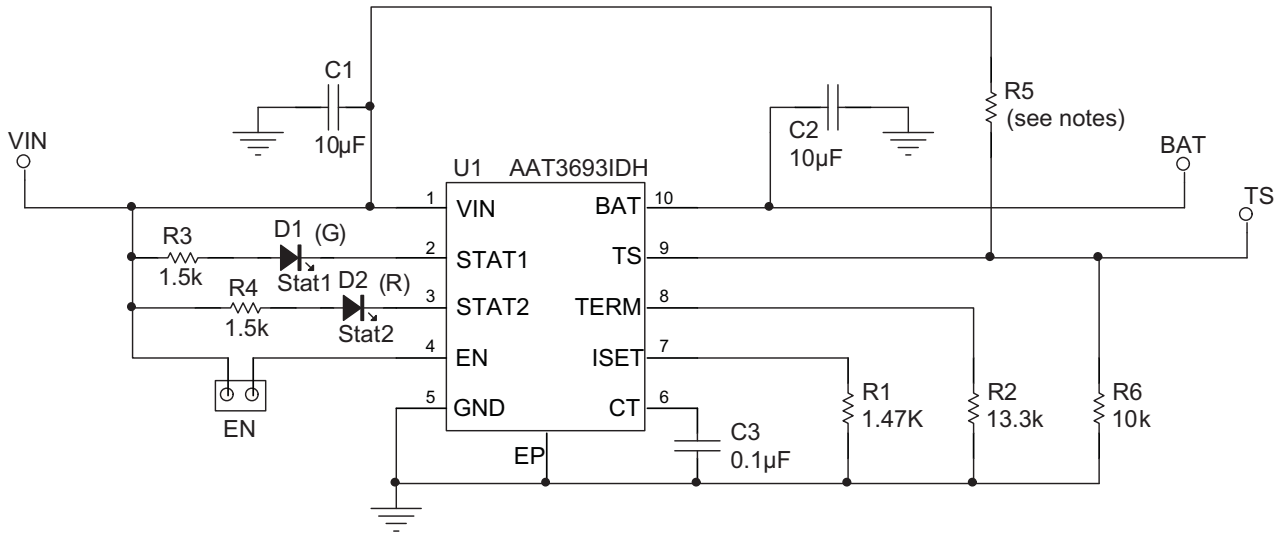

Figure 9: AAT3693 Evaluation Board Bottom Side Layout.

DATA SHEET

AAT3693

1.6A Li-Ion/Polymer Battery Charger in a 2.2x2.2 TDFN Package



R5: 10k for options AA, AB, AE, AF, AI, AJ, BM, BN
R5: OPEN for options AC, AD, AG, AH, AK, AL, BO, BP

Figure 10: AAT3693 Evaluation Board Schematic.

Component	Part Number	Description	Manufacturer
U1	AAT3693IDH	1.6A Linear Li-Ion/Polymer Battery Charger in 2.2x2.2 TDFN Package	Skyworks
R1	CRCW04021501F	1.47KΩ, 1%, 1/4W; 0603	Vishay
R2	CRCW04021332F	13.3KΩ, 1%, 1/4W; 0603	Vishay
R5, R6	CRCW04021002F	10KΩ, 5%, 1/4W; 0603	Vishay
R3, R4	CRCW04021001F	1.5KΩ, 5%, 1/4W; 0603	Vishay
C1, C2	GRM21BR71A106KE51L	CER 10µF 10V 10% X7R 0805	Murata
C3	TMK105BJ104KV	CER 0.1µF 25V 10% X5RR 0402	Taiyo Yuden
EN	PRPN401PAEN	Conn. Header, 2mm zip	Sullins Electronics
D1	LTST-C190GKT	Green LED; 0603	Lite-On Inc.
D2	LTST-C190CKT	Red LED; 0603	Lite-On Inc.

Table 9: AAT3693 Evaluation Board Bill of Materials (BOM).

1.6A Li-Ion/Polymer Battery Charger in a 2.2x2.2 TDFN Package

Option Name	Trickle Charge Mode	Temperature Sense		Low Battery Check	Status Reporting		Charge Timer			Constant Output Voltage $V_{CO(REG)}$, V
		Low Threshold	High Threshold		STAT1	STAT2	Trickle Charge (TC) Timeout	Constant Current (CC) Charge Timeout	Constant Voltage (CV) Charge Timeout	
AA	Yes	30% of V_{VIN}	60% of V_{VIN}	Yes	Yes	Type 1	3 hours total			4.2
AB	No	30% of V_{VIN}	60% of V_{VIN}	Yes	Yes	Type 1	3 hours total			4.2
AC	Yes	0.33V Fixed	2.39V Fixed	Yes	Yes	Type 2	3 hours total			4.2
AD	No	0.33V Fixed	2.39V Fixed	Yes	Yes	Type 2	3 hours total			4.2
AE	Yes	30% of V_{VIN}	60% of V_{VIN}	Yes	Yes	Type 1	25 min	1 hour	2 hours	4.2
AF	No	30% of V_{VIN}	60% of V_{VIN}	Yes	Yes	Type 1	25 min	1 hour	2 hours	4.2
AG	Yes	0.33V Fixed	2.39V Fixed	Yes	Yes	Type 2	25 min	1 hour	2 hours	4.2
AH	No	0.33V Fixed	2.39V Fixed	Yes	Yes	Type 2	25 min	1 hour	2 hours	4.2
AI	Yes	30% of V_{VIN}	60% of V_{VIN}	No	Yes	Type 1	3 hours total			4.2
AJ	No	30% of V_{VIN}	60% of V_{VIN}	No	Yes	Type 1	3 hours total			4.2
AK	Yes	0.33V Fixed	2.39V Fixed	No	Yes	Type 2	3 hours total			4.2
AL	No	0.33V Fixed	2.39V Fixed	No	Yes	Type 2	3 hours total			4.2
BM	Yes	30% of V_{VIN}	60% of V_{VIN}	Yes	Yes	Type 1	25 min	1 hour	2 hours	4.37
BN	No	30% of V_{VIN}	60% of V_{VIN}	Yes	Yes	Type 1	25 min	1 hour	2 hours	4.37
BO	Yes	0.33V Fixed	2.39V Fixed	Yes	Yes	Type 2	25 min	1 hour	2 hours	4.37
BP	No	0.33V Fixed	2.39V Fixed	Yes	Yes	Type 2	25 min	1 hour	2 hours	4.37

Table 10: AAT3693 Options.

1.6A Li-Ion/Polymer Battery Charger in a 2.2x2.2 TDFN Package**Ordering Information**

Package	Marking ¹	Part Number (Tape and Reel) ²
TDFN-10 (2.2x2.2mm)	5FXYY	AAT3693IDH-AA-T1
TDFN-10 (2.2x2.2mm)	7DXYY	AAT3693IDH-AB-T1
TDFN-10 (2.2x2.2mm)		AAT3693IDH-AC-T1
TDFN-10 (2.2x2.2mm)		AAT3693IDH-AD-T1
TDFN-10 (2.2x2.2mm)		AAT3693IDH-AE-T1
TDFN-10 (2.2x2.2mm)		AAT3693IDH-AF-T1
TDFN-10 (2.2x2.2mm)		AAT3693IDH-AG-T1
TDFN-10 (2.2x2.2mm)		AAT3693IDH-AH-T1
TDFN-10 (2.2x2.2mm)	5GXYY	AAT3693IDH-AI-T1
TDFN-10 (2.2x2.2mm)	7EXYY	AAT3693IDH-AJ-T1
TDFN-10 (2.2x2.2mm)		AAT3693IDH-AK-T1
TDFN-10 (2.2x2.2mm)		AAT3693IDH-AL-T1
TDFN-10 (2.2x2.2mm)		AAT3693IDH-BM-T1
TDFN-10 (2.2x2.2mm)		AAT3693IDH-BN-T1
TDFN-10 (2.2x2.2mm)		AAT3693IDH-BO-T1
TDFN-10 (2.2x2.2mm)		AAT3693IDH-BP-T1



Skyworks Green™ products are compliant with all applicable legislation and are halogen-free.

For additional information, refer to *Skyworks Definition of Green™*, document number SQ04-0074.

1. XYY = assembly and date code.

2. Sample stock is generally held on part numbers listed in **BOLD**.

1.6A Li-Ion/Polymer Battery Charger in a 2.2x2.2 TDFN Package

Packaging Information¹

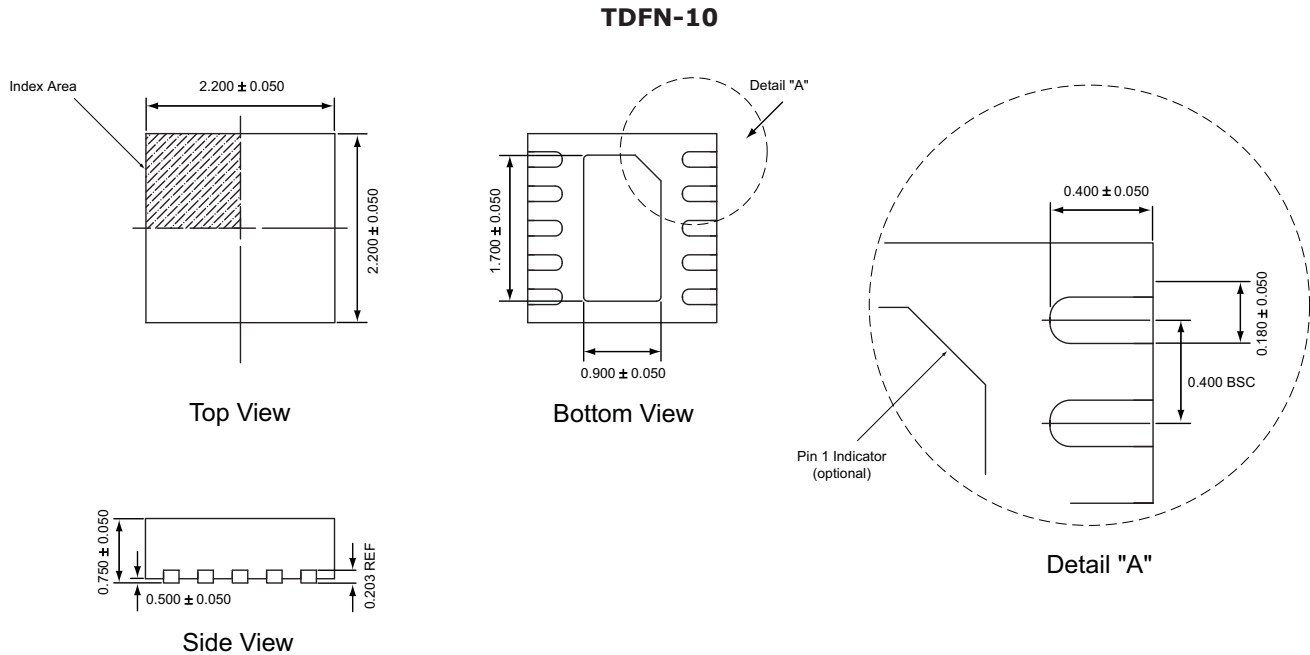

All dimensions in millimeters.

1. The leadless package family, which includes QFN, TQFN, DFN, TDFN and STDFN, has exposed copper (unplated) at the end of the lead terminals due to the manufacturing process. A solder fillet at the exposed copper edge cannot be guaranteed and is not required to ensure a proper bottom solder connection.

Copyright © 2012 Skyworks Solutions, Inc. All Rights Reserved.

Information in this document is provided in connection with Skyworks Solutions, Inc. ("Skyworks") products or services. These materials, including the information contained herein, are provided by Skyworks as a service to its customers and may be used for informational purposes only by the customer. Skyworks assumes no responsibility for errors or omissions in these materials or the information contained herein. Skyworks may change its documentation, products, services, specifications or product descriptions at any time, without notice. Skyworks makes no commitment to update the materials or information and shall have no responsibility whatsoever for conflicts, incompatibilities, or other difficulties arising from any future changes.

No license, whether express, implied, by estoppel or otherwise, is granted to any intellectual property rights by this document. Skyworks assumes no liability for any materials, products or information provided hereunder, including the sale, distribution, reproduction or use of Skyworks products, information or materials, except as may be provided in Skyworks Terms and Conditions of Sale.

THE MATERIALS, PRODUCTS AND INFORMATION ARE PROVIDED "AS IS" WITHOUT WARRANTY OF ANY KIND, WHETHER EXPRESS, IMPLIED, STATUTORY, OR OTHERWISE, INCLUDING FITNESS FOR A PARTICULAR PURPOSE OR USE, MERCHANTABILITY, PERFORMANCE, QUALITY OR NON-INFRINGEMENT OF ANY INTELLECTUAL PROPERTY RIGHT; ALL SUCH WARRANTIES ARE HEREBY EXPRESSLY DISCLAIMED. SKYWORKS DOES NOT WARRANT THE ACCURACY OR COMPLETENESS OF THE INFORMATION, TEXT, GRAPHICS OR OTHER ITEMS CONTAINED WITHIN THESE MATERIALS. SKYWORKS SHALL NOT BE LIABLE FOR ANY DAMAGES, INCLUDING BUT NOT LIMITED TO ANY SPECIAL, INDIRECT, INCIDENTAL, STATUTORY, OR CONSEQUENTIAL DAMAGES, INCLUDING WITHOUT LIMITATION, LOST REVENUES OR LOST PROFITS THAT MAY RESULT FROM THE USE OF THE MATERIALS OR INFORMATION, WHETHER OR NOT THE RECIPIENT OF MATERIALS HAS BEEN ADVISED OF THE POSSIBILITY OF SUCH DAMAGE.

Skyworks products are not intended for use in medical, lifesaving or life-sustaining applications, or other equipment in which the failure of the Skyworks products could lead to personal injury, death, physical or environmental damage. Skyworks customers using or selling Skyworks products for use in such applications do so at their own risk and agree to fully indemnify Skyworks for any damages resulting from such improper use or sale.

Customers are responsible for their products and applications using Skyworks products, which may deviate from published specifications as a result of design defects, errors, or operation of products outside of published parameters or design specifications. Customers should include design and operating safeguards to minimize these and other risks. Skyworks assumes no liability for applications assistance, customer product design, or damage to any equipment resulting from the use of Skyworks products outside of stated published specifications or parameters.

Skyworks, the Skyworks symbol, and "Breakthrough Simplicity" are trademarks or registered trademarks of Skyworks Solutions, Inc., in the United States and other countries. Third-party brands and names are for identification purposes only, and are the property of their respective owners. Additional information, including relevant terms and conditions, posted at www.skyworksinc.com, are incorporated by reference.