

*Current Limited Load Switch in an SOT23 Package*

**General Description**

The AAT4611 SmartSwitch is a current limited P-channel MOSFET power switch designed for high-side load switching applications. This switch operates with inputs ranging from 2.7V to 5.5V, making it ideal for both 3V and 5V systems. An integrated current-limiting circuit protects the input supply against large currents which may cause the supply to fall out of regulation. The AAT4611 is also protected from thermal overload which limits power dissipation and junction temperatures. It can be used to control loads that require up to 1A. Current limit threshold is programmed with a resistor from SET to ground. The quiescent supply current is typically a low 15µA max. In shutdown mode, the supply current decreases to less than 1µA.

The AAT4611 is available in a Pb-free 5-pin SOT23 package and is specified over the -40°C to +85°C temperature range.

**Features**

- Input Voltage Range: 2.7V to 5.5V
- Programmable Over-Current Threshold
- Fast Transient Response:
  - <1µs Response to Short Circuit
- Low Quiescent Current
  - 15µA Typical
  - 1µA Max with Switch Off
- 160mΩ Typical  $R_{DS(ON)}$
- Only 2.5V Needed for ON/OFF Control
- Under-Voltage Lockout
- Thermal Shutdown
- 4kV ESD Rating
- 5-Pin SOT23 Package
- Temperature Range: -40°C to +85°C

**Applications**

- Hot Swap Supplies
- Notebook Computers
- Peripheral Ports
- Personal Communication Devices

**Typical Application**

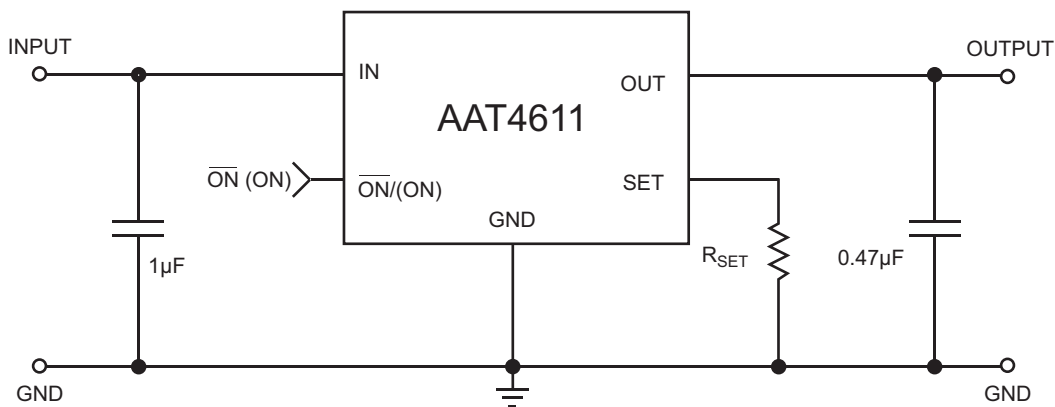

*Current Limited Load Switch in an SOT23 Package*

**Pin Descriptions**

Pin #	Symbol	Function
1	OUT	P-channel MOSFET drain. Connect a 0.47 $\mu$ F capacitor from OUT to GND.
2	GND	Ground connection.
3	SET	Current limit set input. A resistor from SET to ground sets the current limit for the switch.
4	$\overline{\text{ON}}$	Enable input. Two versions are available, active-high and active-low. See Ordering Information for details.
5	IN	P-channel MOSFET source. Connect a 1 $\mu$ F capacitor from IN to GND.

**Pin Configuration**

**SOT23-5  
(Top View)**

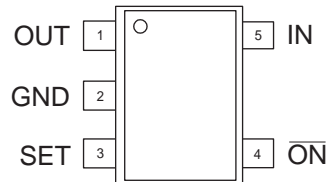

*Current Limited Load Switch in an SOT23 Package*

### Absolute Maximum Ratings<sup>1</sup>

$T_A = 25^\circ\text{C}$ , unless otherwise noted.

Symbol	Description	Value	Units
$V_{IN}$	IN to GND	-0.3 to 6	V
$V_{ON}$	ON ( $\overline{ON}$ ) to GND	-0.3 to $V_{IN} + 0.3$	V
$V_{SET}, V_{OUT}$	SET, OUT to GND	-0.3 to $V_{IN} + 0.3$	V
$I_{MAX}$	Maximum Continuous Switch Current	2	A
$T_J$	Operating Junction Temperature Range	-40 to 150	$^\circ\text{C}$
$T_{LEAD}$	Maximum Soldering Temperature (at leads)	300	$^\circ\text{C}$
$V_{ESD}$	ESD Rating <sup>2</sup> - HBM	4000	V

### Thermal Characteristics<sup>3</sup>

Symbol	Description	Value	Units
$\Theta_{JA}$	Thermal Resistance	150	$^\circ\text{C}/\text{W}$
$P_D$	Power Dissipation	667	mW

1. Stresses above those listed in Absolute Maximum Ratings may cause permanent damage to the device. Functional operation at conditions other than the operating conditions specified is not implied. Only one Absolute Maximum Rating should be applied at any one time.  
 2. Human body model is a 100pF capacitor discharged through a 1.5k $\Omega$  resistor into each pin.  
 3. Mounted on a demo board.

# DATA SHEET

# AAT4611

## Current Limited Load Switch in an SOT23 Package

### Electrical Characteristics

$V_{IN} = 5V$ ,  $T_A = -40^{\circ}C$  to  $+85^{\circ}C$ , unless otherwise noted. Typical values are  $T_A = 25^{\circ}C$ .

Symbol	Description	Conditions	Min	Typ	Max	Units
$V_{IN}$	Operation Voltage		2.7		5.5	V
$I_Q$	Quiescent Current	$V_{IN} = 5V$ , ON ( $\overline{ON}$ ) = Active, $I_{OUT} = 0$		15	30	$\mu A$
$I_{Q(OFF)}$	Off-Supply Current	ON ( $\overline{ON}$ ) = Inactive, $V_{IN} = 5.5V$			1	$\mu A$
$I_{SD(OFF)}$	Off-Switch Current	ON ( $\overline{ON}$ ) = Inactive, $V_{IN} = 5.5V$ , $V_{OUT} = 0$		0.03	15	$\mu A$
$V_{UVLO}$	Under-Voltage Lockout	Rising Edge, 1% Hysteresis	2.0	2.3	2.7	V
$R_{DS(ON)}$	On Resistance	$V_{IN} = 5.0V$		160	180	$m\Omega$
		$V_{IN} = 4.5V$		165		
		$V_{IN} = 3.0V$		195	230	
$I_{LIM}$	Current Limit	$R_{SET} = 6.8k\Omega$	0.75	1	1.25	A
$I_{LIM(MIN)}$	Minimum Current Limit			130	195	mA
$V_{ON(L)}$	ON ( $\overline{ON}$ ) Input Low Voltage				0.8	V
$V_{ON(H)}$	ON ( $\overline{ON}$ ) Input High Voltage	$V_{IN} = 2.7V$ to $3.6V$	2.0			V
		$V_{IN} = 4.5V$ to $5.5V$	2.4			
$I_{ON(SINK)}$	ON ( $\overline{ON}$ ) Input Leakage	$V_{ON} = 5.5V$		0.01	1	$\mu A$
$T_{RESP}$	Current Limit Response Time	$V_{IN} = 5V$		0.8		$\mu s$
$T_{OFF}$	Turn-Off Time	$V_{IN} = 5V$ , $R_L = 10\Omega$		0.4	2	$\mu s$
$T_{ON}$	Turn-On Time	$V_{IN} = 5V$ , $R_L = 10\Omega$		40	200	$\mu s$

## Current Limited Load Switch in an SOT23 Package

### Typical Characteristics

Unless otherwise noted,  $V_{IN} = 5V$ ,  $T_A = 25^\circ C$ .

**Quiescent Current vs. Temperature**

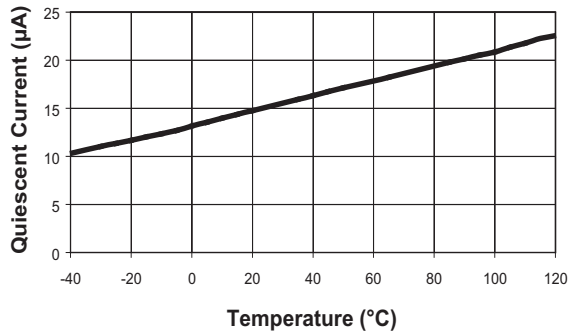

**Quiescent Current vs. Input Voltage**

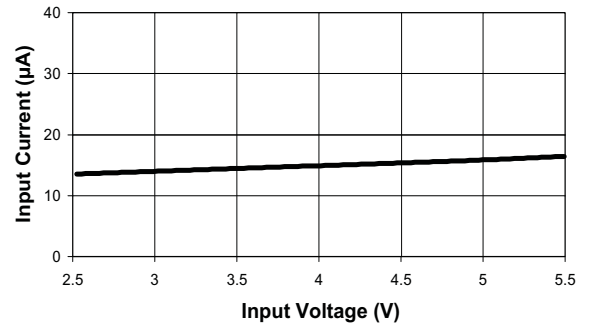

**Output Current vs. Output Voltage**  
( $R_{SET} = 16k\Omega$ )

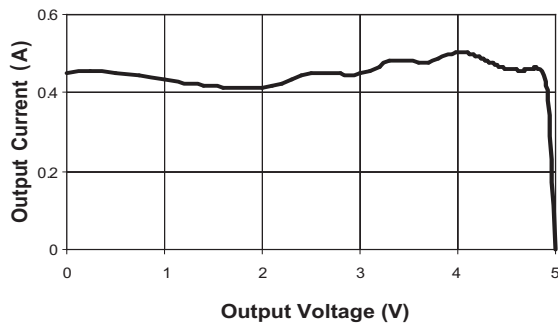

**$R_{DS(ON)}$  vs. Temperature**

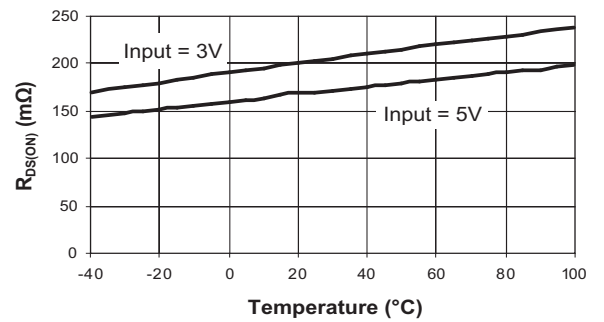

**Off-Supply Current vs. Temperature**

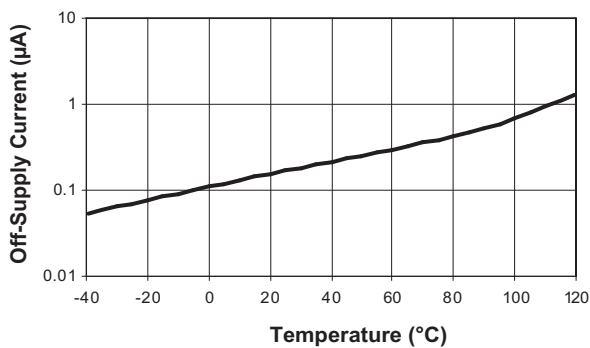

**Off-Switch Current vs. Temperature**

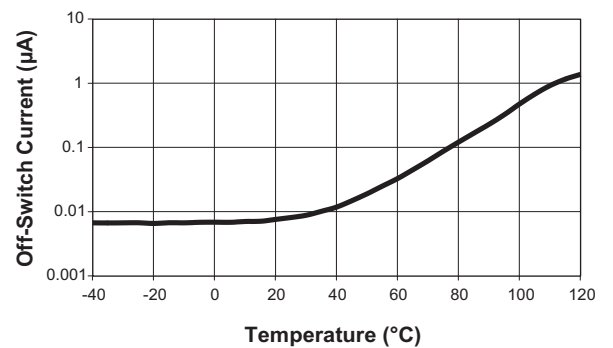

## Current Limited Load Switch in an SOT23 Package

### Typical Characteristics

Unless otherwise noted,  $V_{IN} = 5V$ ,  $T_A = 25^\circ C$ .

**Turn-On vs. Temperature**

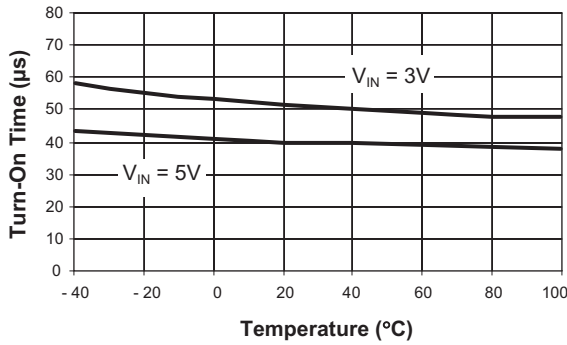

**Turn-Off vs. Temperature**

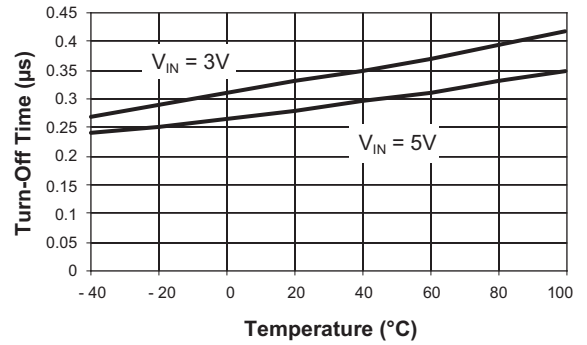

**Turn On**  
( $R_L = 10\Omega$ ;  $C_L = 0.47\mu F$ ;  $I_{OUT} = I_{LIMIT}$ )

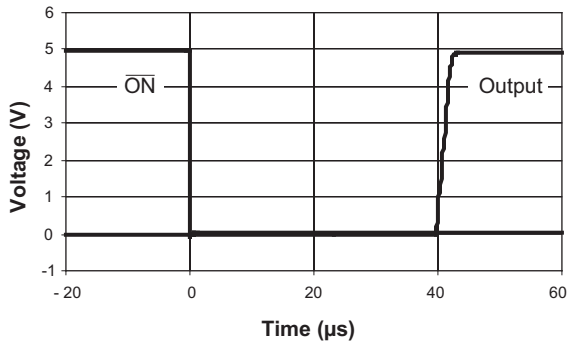

**Turn Off**  
( $R_L = 10\Omega$ ;  $I_{OUT} = I_{LIMIT}$ )

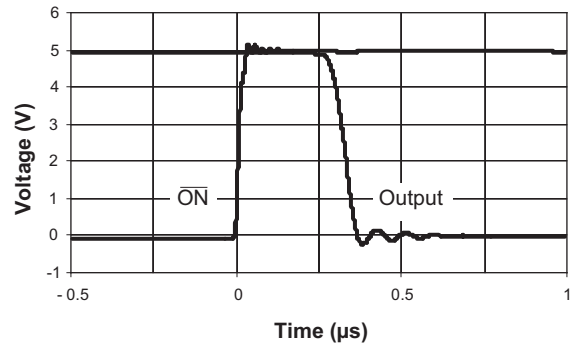

**Short-Circuit Through 0.3Ω**

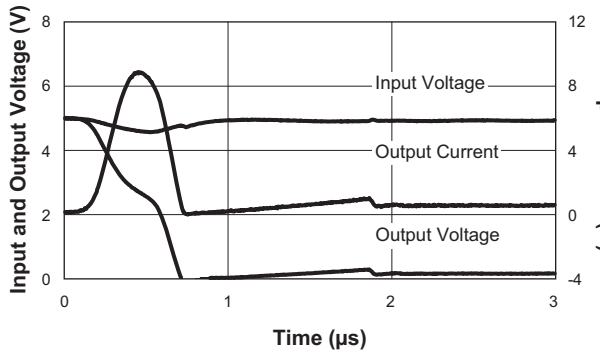

**Short-Circuit Through 0.6Ω**

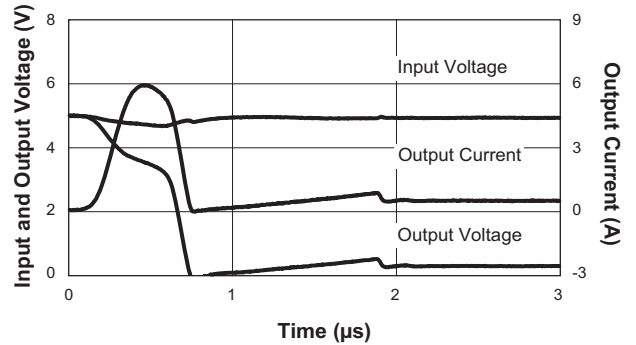

*Current Limited Load Switch in an SOT23 Package*

**Typical Characteristics**

Unless otherwise noted,  $V_{IN} = 5V$ ,  $T_A = 25^\circ C$ .

**$R_{SET}$  vs.  $I_{LIM}$**

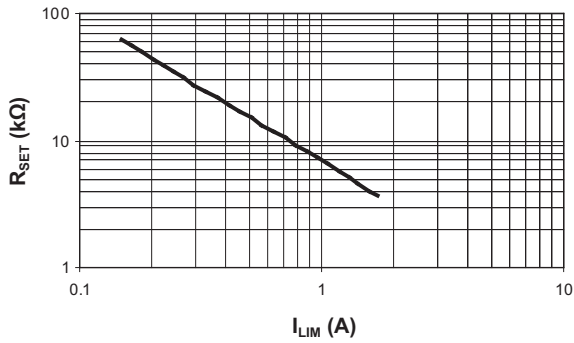

**$R_{SET}$  Coefficient vs.  $I_{LIM}$**

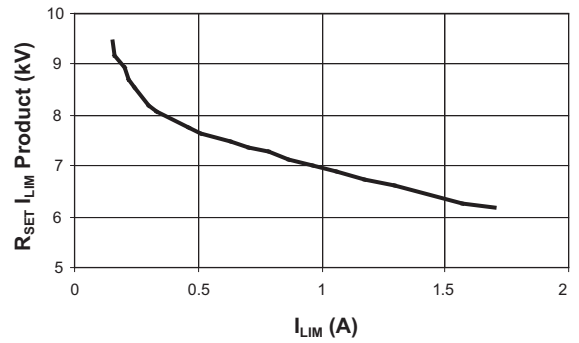

**Current Limit vs. Temperature**  
 ( $R_{SET} = 22.1k\Omega$ ;  $V_{IN} - V_{OUT} = 0.5V$ )

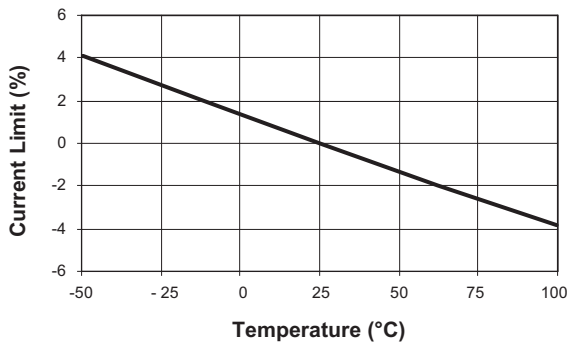

### Functional Block Diagram

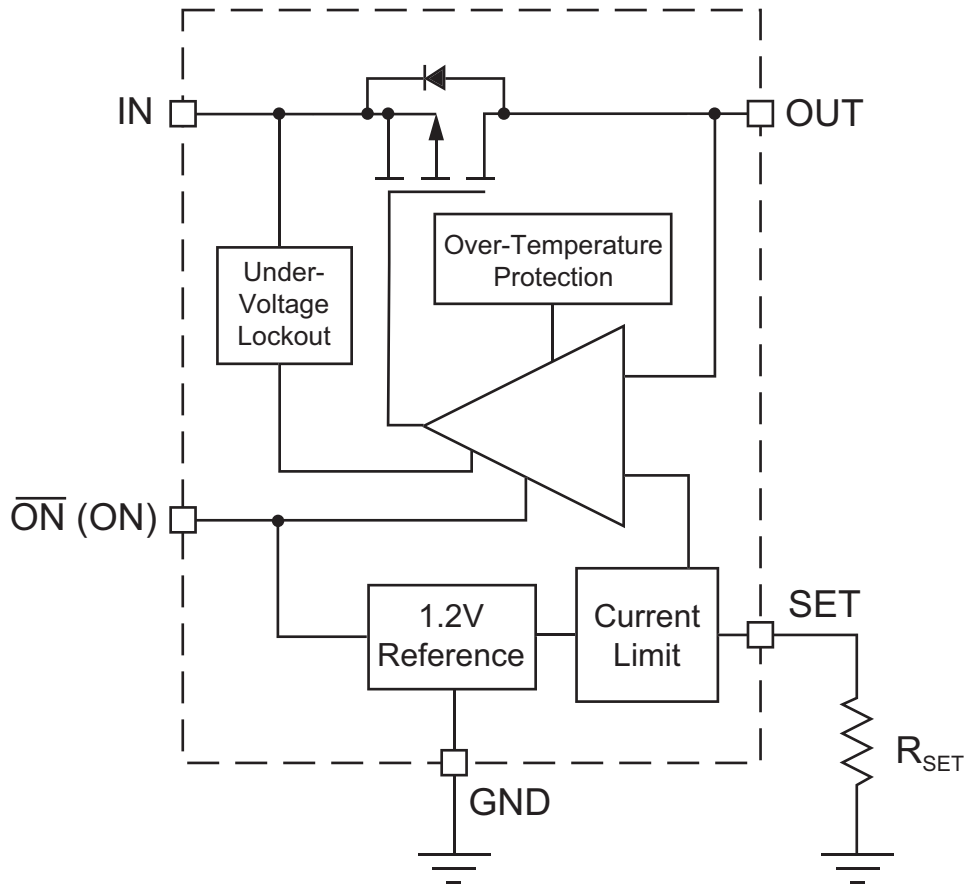

### Applications Information

#### Setting Current Limit

In most applications, the variation in  $I_{LIM}$  must be taken into account when determining  $R_{SET}$ . The  $I_{LIM}$  variation is due to processing variations from part to part, as well as variations in the voltages at IN (Pin 5) and OUT (Pin 1) and the operating temperature. See charts "Current Limit vs. Temperature" and "Output Current vs. Output Voltage." Together, these three factors add up to a  $\pm 25\%$  tolerance (see  $I_{LIM}$  specification in Electrical Characteristics section). In Figure 1, a cold device with a statistically higher current limit and a hot device with a statistically lower current limit, both with  $R_{SET}$  equal to  $10.5k\Omega$ , are shown. While the chart, " $R_{SET}$  vs.  $I_{LIM}$ " indicates an  $I_{LIM}$  of  $0.7A$  with an  $R_{SET}$  of  $10.5k\Omega$ , this figure shows that the actual current limit will be at least  $0.525A$  and no greater than  $0.880A$ .

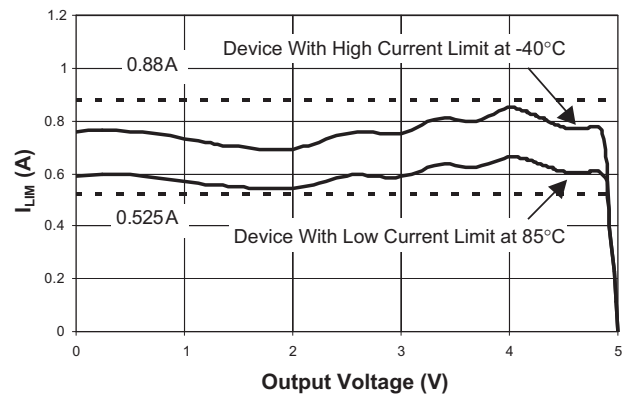

**Figure 1: Current Limit Using  $10.5k\Omega$ .**

To determine  $R_{SET}$ , start with the maximum current drawn by the load and multiply it by 1.33 (typical  $I_{LIM}$  = minimum  $I_{LIM}$  / 0.75). This is the typical current limit value. Next, refer to " $R_{SET}$  vs.  $I_{LIM}$ " and find the  $R_{SET}$  that corresponds



## Current Limited Load Switch in an SOT23 Package

to the typical current limit value; choose the largest resistor available that is less than or equal to it. For greater precision, the value of  $R_{SET}$  may also be calculated using the  $I_{LIM} R_{SET}$  product found in the chart "R<sub>SET</sub> Coefficient vs. I<sub>LIM</sub>." The maximum current is derived by multiplying the typical current for the chosen  $R_{SET}$  in the chart by 1.25. Some standard resistor values are listed in Table 1.

$R_{SET}$ (k $\Omega$ )	Current Limit (Typ) (mA)	Device Will Not Current Limit Below (mA)	Device Always Current Limits Below (mA)
40.2	200	150	250
30.9	250	188	313
24.9	300	225	375
22.1	350	263	438
19.6	400	300	500
17.8	450	338	563
16.2	500	375	625
14.7	550	413	688
13.0	600	450	750
10.5	700	525	875
8.87	800	600	1000
7.50	900	675	1125
6.81	1000	750	1250
6.04	1100	825	1375
5.49	1200	900	1500
4.99	1300	975	1625
4.64	1400	1050	1750

**Table 1: Current Limit  $R_{SET}$  Values.**

Example: A USB port requires 0.5A. 0.5A multiplied by 1.33 is 0.665A. From the chart "R<sub>SET</sub> vs. I<sub>LIM</sub>,"  $R_{SET}$  should be less than 11k $\Omega$ . 10.5 k $\Omega$  is a standard value that is slightly less than, but very close to, 11k $\Omega$ . The chart

gives approximately 0.7A as a typical  $I_{LIM}$  value for 10.5k $\Omega$ . Multiplying 0.7A by 0.75 and 1.25 shows that the AAT4611 will limit the load current to greater than 0.525A but less than 0.875A.

### Operation in Current Limit

When a heavy load is applied to the output of the AAT4611, the load current is limited to the value of  $I_{LIM}$  determined by  $R_{SET}$  (see Figure 2). Since the load is demanding more current than  $I_{LIM}$ , the voltage at the output drops. This causes the AAT4611 to dissipate a larger-than-normal quantity of power, and causes the die temperature to increase. When the die temperature exceeds an over-temperature limit, the AAT4611 will shut down until it has cooled sufficiently, at which point it will start up again. The AAT4611 will continue to cycle on and off until the load is removed, power is removed, or until a logic high level is applied to  $\overline{ON}$  (Pin 4).

### Enable Input

In many systems, power planes are controlled by integrated circuits which run at lower voltages than the power plane itself. The enable input  $\overline{ON}$  (Pin 4) of the AAT4611 has low and high threshold voltages that accommodate this condition. The threshold voltages are compatible with 5V TTL and 2.5V to 5V CMOS.

### Reverse Voltage

The AAT4611 is designed to control current flowing from IN to OUT. If a voltage is applied to OUT which is greater than the voltage on IN, large currents may flow. This could cause damage to the AAT4611.

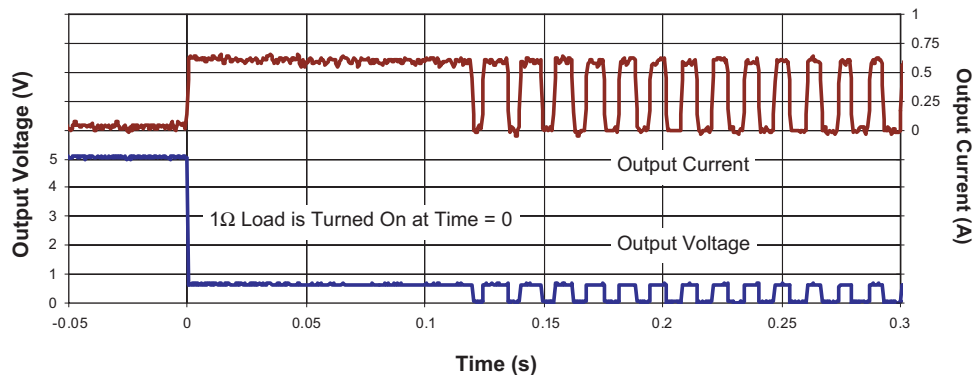

**Figure 2: Overload Operation.**

## Current Limited Load Switch in an SOT23 Package

### Ordering Information

Package	Enable	Marking <sup>1</sup>	Part Number (Tape and Reel) <sup>2</sup>
SOT23-5	$\overline{\text{ON}}$ (active low)	CLXYY	<b>AAT4611IGV-T1</b>
SOT23-5	ON (active high)		



Skyworks Green™ products are compliant with all applicable legislation and are halogen-free.



For additional information, refer to *Skyworks Definition of Green™*, document number SQ04-0074.

### Package Information

#### SOT23-5

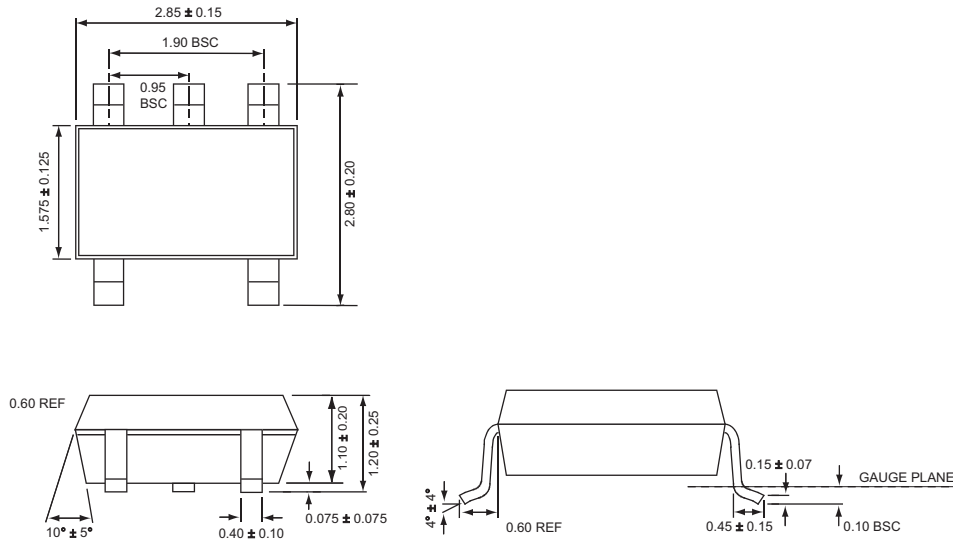

All dimensions in millimeters.

1. XYY = assembly and date code.
2. Sample stock is generally held on part numbers listed in **BOLD**.

Copyright © 2012 Skyworks Solutions, Inc. All Rights Reserved.

Information in this document is provided in connection with Skyworks Solutions, Inc. ("Skyworks") products or services. These materials, including the information contained herein, are provided by Skyworks as a service to its customers and may be used for informational purposes only by the customer. Skyworks assumes no responsibility for errors or omissions in these materials or the information contained herein. Skyworks may change its documentation, products, services, specifications or product descriptions at any time, without notice. Skyworks makes no commitment to update the materials or information and shall have no responsibility whatsoever for conflicts, incompatibilities, or other difficulties arising from any future changes.

No license, whether express, implied, by estoppel or otherwise, is granted to any intellectual property rights by this document. Skyworks assumes no liability for any materials, products or information provided hereunder, including the sale, distribution, reproduction or use of Skyworks products, information or materials, except as may be provided in Skyworks Terms and Conditions of Sale.

THE MATERIALS, PRODUCTS AND INFORMATION ARE PROVIDED "AS IS" WITHOUT WARRANTY OF ANY KIND, WHETHER EXPRESS, IMPLIED, STATUTORY, OR OTHERWISE, INCLUDING FITNESS FOR A PARTICULAR PURPOSE OR USE, MERCHANTABILITY, PERFORMANCE, QUALITY OR NON-INFRINGEMENT OF ANY INTELLECTUAL PROPERTY RIGHT; ALL SUCH WARRANTIES ARE HEREBY EXPRESSLY DISCLAIMED. SKYWORKS DOES NOT WARRANT THE ACCURACY OR COMPLETENESS OF THE INFORMATION, TEXT, GRAPHICS OR OTHER ITEMS CONTAINED WITHIN THESE MATERIALS. SKYWORKS SHALL NOT BE LIABLE FOR ANY DAMAGES, INCLUDING BUT NOT LIMITED TO ANY SPECIAL, INDIRECT, INCIDENTAL, STATUTORY, OR CONSEQUENTIAL DAMAGES, INCLUDING WITHOUT LIMITATION, LOST REVENUES OR LOST PROFITS THAT MAY RESULT FROM THE USE OF THE MATERIALS OR INFORMATION, WHETHER OR NOT THE RECIPIENT OF MATERIALS HAS BEEN ADVISED OF THE POSSIBILITY OF SUCH DAMAGE.

Skyworks products are not intended for use in medical, lifesaving or life-sustaining applications, or other equipment in which the failure of the Skyworks products could lead to personal injury, death, physical or environmental damage. Skyworks customers using or selling Skyworks products for use in such applications do so at their own risk and agree to fully indemnify Skyworks for any damages resulting from such improper use or sale.

Customers are responsible for their products and applications using Skyworks products, which may deviate from published specifications as a result of design defects, errors, or operation of products outside of published parameters or design specifications. Customers should include design and operating safeguards to minimize these and other risks. Skyworks assumes no liability for applications assistance, customer product design, or damage to any equipment resulting from the use of Skyworks products outside of stated published specifications or parameters.

Skyworks, the Skyworks symbol, and "Breakthrough Simplicity" are trademarks or registered trademarks of Skyworks Solutions, Inc., in the United States and other countries. Third-party brands and names are for identification purposes only, and are the property of their respective owners. Additional information, including relevant terms and conditions, posted at [www.skyworksinc.com](http://www.skyworksinc.com), are incorporated by reference.