

**DATA SHEET**

# SKY77318 iPAC™ PAM for Quad-Band GSM / GPRS

## Applications

- Quad-Band cellular handsets encompassing
  - Class 4 GSM850/900
  - Class 1 DCS1800/PCS1900
  - Class 12 GPRS multi-slot operation

## Features

- Low input power range
  - 0 to 6 dBm
- High efficiency
  - CELL 58%
  - GSM 56%
  - DCS 56%
  - PCS 56%
- BiCMOS PA controller and interface IC
  - Low power control slope
  - Fast response time
  - Improved control accuracy
- Integrated closed loop power amplifier control
- Internal Icc sense resistor for PAC
- Input/Output matching 50 Ω internal (with DC blocking)
- 20-pad package
- Small outline: 6 x 6 mm
- Low profile: 1.2 mm
- MSL3/260 °C

## Description

The SKY77318 Power Amplifier Module (PAM) is designed in a low profile (1.2 mm), compact form factor for quad-band cellular handsets comprising GSM850/900, DCS1800, and PCS1900 operation. The PAM also supports Class 12 General Packet Radio Service (GPRS) multi-slot operation.

The module consists of separate GSM PA and DCS1800/PCS1900 PA blocks, impedance-matching circuitry for 50 Ω input and output impedances and a Power Amplifier Control (PAC) block with an internal current-sense resistor. The custom BiCMOS integrated circuit provides the internal PAC function and interface circuitry. Fabricated onto a single Gallium Arsenide (GaAs) die, one Heterojunction Bipolar Transistor (HBT) PA block supports the GSM bands and the other supports the DCS1800 and PCS1900 bands. Both PA blocks share common power supply pads to distribute current. The GaAs die, the Silicon (Si) die, and the passive components are mounted on a multi-layer laminate substrate. The assembly is encapsulated with plastic overmold.

RF input and output ports of the SKY77318 are internally matched to a 50 Ω load to reduce the number of external components for a quad-band design. Extremely low leakage current (2.5 μA, typical) of the dual PA module maximizes handset standby time. The SKY77318 also contains band-select switching circuitry to select GSM (logic 0) or DCS/PCS (logic 1) as determined from the Band Select (BS) signal. In Figure 1 below, the BS pad selects the PA output (DCS/PCS\_OUT or GSM\_OUT) and the Analog Power Control (VAPC) controls the level of output power.

The VBATT pad connects to an internal current-sense resistor and interfaces to an integrated power amplifier control (iPAC™) function, which is insensitive to variations in temperature, power supply, process, and input power. The ENABLE input allows initial turn-on of PAM circuitry to minimize battery drain.

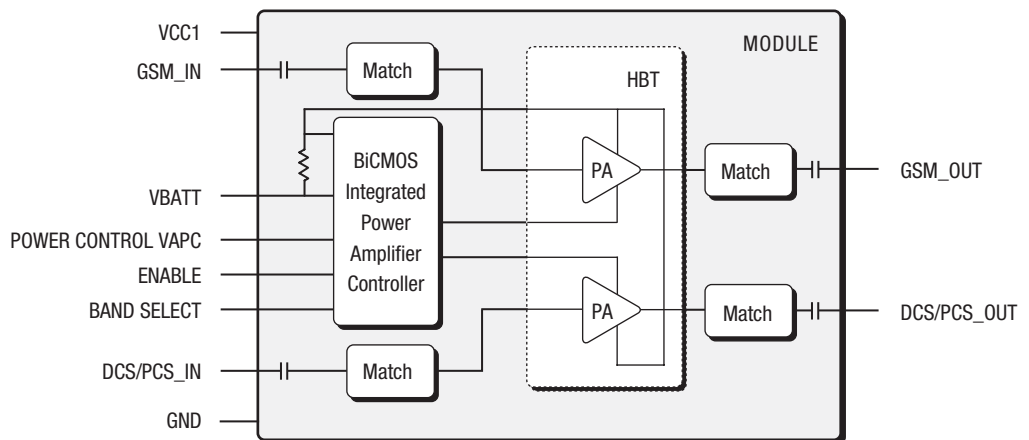

**Figure 1. Functional Block Diagram**

200242\_001

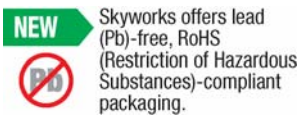

## Electrical Specifications

The following tables list the electrical characteristics of the SKY77318 Power Amplifier Module. [Table 1](#) lists the absolute maximum ratings and [Table 2](#) shows the recommended operating conditions. [Table 3](#) lists the electrical characteristics of the SKY77318 for modes GSM, DCS1800, and PCS1900. [Figure 2](#) is a diagram of a typical SKY77318 application.

The SKY77318 is a static-sensitive electronic device and should not be stored or operated near strong electrostatic fields. Detailed information on device dimensions, pad descriptions, packaging and handling can be found in later sections of this data sheet.

**Table 1. Absolute Maximum Ratings**

Parameter	Minimum	Maximum	Unit
Input Power (P <sub>IN</sub> )	—	15	dBm
Supply Voltage (V <sub>CC</sub> ), Standby, V <sub>APC</sub> ≤ 0.3 V, ENABLE ≤ 0.2 V	—	7	V
Control Voltage (V <sub>APC</sub> )	-0.5	V <sub>CC_MAX</sub> - 0.2 (See <a href="#">Table 3</a> )	V
Storage Temperature	-55	+150	°C

**Table 2. Recommended Operating Conditions**

Parameter	Minimum	Typical	Maximum	Unit
Supply Voltage (V <sub>CC</sub> )	2.9	3.5	4.8	V
Supply Current (I <sub>CC</sub> )	0	—	2.5	A
Operating Case Temperature (T <sub>CASE</sub> ) – Package Bottom Surface				°C
1-Slot (12.5% duty cycle)	-20	—	+100	
2-Slot (25.0% duty cycle)	-20	—	+100	
3-Slot (37.5% duty cycle)	-20	—	+85	
4-Slot (50.0% duty cycle)	-20	—	+85	

**Table 3. SKY77318 Electrical Specifications (1 of 9)**

General						
Parameter	Symbol	Test Condition	Minimum	Typical	Maximum	Units
Supply voltage	V <sub>CC</sub>	—	2.9	3.5	4.8	V
Power control impedance	Z <sub>APC</sub>	—	—	200	—	kΩ
ENABLE control voltage	Low	V <sub>PE</sub>	—	-0.1	0.6	V
	High	V <sub>PE</sub>	—	1.2	V <sub>CC</sub>	
ENABLE current	I <sub>PE</sub>	V <sub>PE</sub> ≤ 3.0 V	—	—	30	μA
Band Select control voltage	Low	V <sub>BS</sub>	—	-0.1	0.6	V
	High	V <sub>BS</sub>	—	1.2	V <sub>CC</sub>	
Band Select current	I <sub>BS</sub>	V <sub>BS</sub> ≤ 3.0 V	—	—	30	μA
Standby Mode Leakage current	I <sub>Q</sub>	V <sub>CC</sub> ≤ 4.5 V V <sub>APC</sub> = 0.1 V ENABLE ≤ 0.2 V T <sub>CASE</sub> = +25 °C P <sub>IN</sub> ≤ -60 dBm	—	2.5	10	μA
V <sub>APC</sub> Input Filter Bandwidth	V <sub>APC_FBW</sub>	—	85	120	150	kHz
V <sub>APC</sub> Threshold	V <sub>APC_THCL</sub>	—	100	150	200	mV

**Table 3. SKY77318 Electrical Specifications<sup>1</sup> (2 of 9)**

GSM850 Mode (f = 824 to 849 MHz and P <sub>IN</sub> = 0 to 6 dBm)						
Parameter	Symbol	Test Condition	Minimum	Typical	Maximum	Units
Frequency range	f	—	824	—	849	MHz
Input power	P <sub>IN</sub>	—	0	—	6	dBm
Analog power control voltage	V <sub>APC</sub>	—	0.2	—	1.7	V
Power Added Efficiency	PAE	V <sub>CC</sub> = 3.5 V P <sub>OUT</sub> = 34.75 dBm ENABLE > 2.0 V pulse width 577 μs duty cycle 1:8 T <sub>CASE</sub> = +25 °C	50	58	—	%
2nd to 13th harmonics	2f <sub>0</sub> to 13f <sub>0</sub>	BW = 3 MHz 6.5 dBm ≤ P <sub>out</sub> ≤ 34.75 dBm	—	—	-10	dBm
Output power	P <sub>OUT_MAX</sub>	V <sub>CC</sub> = 3.5 V T <sub>CASE</sub> = +25 °C	34.75	35.2	—	dBm
	P <sub>OUT_MAX</sub> LOW VOLTAGE	V <sub>CC</sub> = 2.9 V ENABLE > 2.0 V T <sub>CASE</sub> = -20 °C to +100 °C (See Table 2 for multi-slot.) P <sub>IN</sub> = 0 dBm	32.5	—	—	
	P <sub>OUT_MAX</sub> HIGH VOLTAGE	V <sub>CC</sub> = 4.5 V ENABLE > 2.0 V T <sub>CASE</sub> = -20 °C to +100 °C (See Table 2 for multi-slot.) P <sub>IN</sub> = 0 dBm	32.5	—	—	
Input VSWR	Γ <sub>IN</sub>	P <sub>OUT</sub> = 6.5 to 34.75 dBm, controlled by V <sub>APC</sub>	—	1.5:1	2.5:1	—
Forward isolation	P <sub>OUT_STANDBY</sub>	P <sub>IN</sub> = 6 dBm V <sub>APC</sub> = 0.1 V ENABLE ≤ 0.2 V	—	—	-35	dBm
Spurious	Spur	All combinations of the following parameters: V <sub>APC</sub> = controlled <sup>2</sup> P <sub>IN</sub> = min. to max. V <sub>CC</sub> = 2.9 V to 4.8 V Load VSWR = 8:1, all phase angles	No parasitic oscillation > -36 dBm			

**Table 3. SKY77318 Electrical Specifications<sup>1</sup> (3 of 9)**

GSM850 Mode (f = 824 to 849 MHz and P <sub>IN</sub> = 0 to 6 dBm) [continued]						
Parameter	Symbol	Test Condition	Minimum	Typical	Maximum	Units
Load mismatch	Load	All combinations of the following parameters: V <sub>APC</sub> = controlled <sup>2</sup> P <sub>IN</sub> = min. to max. V <sub>CC</sub> = 2.9 V to 4.8 V Load VSWR = 10:1, all phase angles	No module damage or permanent degradation			
Noise power	P <sub>NOISE</sub>	At f <sub>o</sub> + 20 MHz RBW = 100 kHz V <sub>CC</sub> = 3.5 V 6.5 dBm ≤ P <sub>OUT</sub> ≤ 34.75 dBm T <sub>CASE</sub> = +25 °C	—	—	-81	dBm
		At f <sub>o</sub> + 10 MHz RBW = 100 kHz V <sub>CC</sub> = 3.5 V 6.5 dBm ≤ P <sub>OUT</sub> ≤ 34.75 dBm T <sub>CASE</sub> = +25 °C	—	—	-76	
		At 1805 to 1880 MHz RBW = 100 kHz V <sub>CC</sub> = 3.5 V 6.5 dBm ≤ P <sub>OUT</sub> ≤ 34.75 dBm T <sub>CASE</sub> = +25 °C	—	—	-84	
Coupling of Fundamental, 2nd, and 3rd harmonics from the GSM band into the DCS/PCS band	f <sub>o</sub>	Measured at the DCS/PCS output, -15 dBm ≤ P <sub>OUT</sub> ≤ 34.75 dBm V <sub>CC</sub> = 3.5 V T <sub>CASE</sub> = +25 °C	—	—	3	dBm
	2f <sub>o</sub>		—	—	-14	
	3f <sub>o</sub>		—	—	-17	
Power control dynamic range	P <sub>CDR</sub>	—	30	50	—	dB
Power control variation <sup>4</sup> (Control level 5–15) 3.2 ≤ V <sub>CC</sub> ≤ 4.5	P <sub>CV</sub>	P <sub>OUT</sub> = 14.5 to +34.75 dBm, +25 °C	-0.8	—	0.8	dB
Power control variation <sup>4</sup> (Control level 16–19)		P <sub>OUT</sub> = 14.5 to +34.75 dBm	-1.3	—	1.3	
Power control variation <sup>4</sup> (Control level 16–19)	P <sub>CV</sub>	P <sub>OUT</sub> = 6.5 to +12.5 dBm, +25 °C	-1.1	—	1.1	dB
		P <sub>OUT</sub> = 6.5 to +12.5 dBm	-1.7	—	1.7	
Power control slope	P <sub>CS</sub>	6.5 to 34.75 dBm	—	—	150	dB/V

**Table 3. SKY77318 Electrical Specifications<sup>1</sup> (4 of 9)**

GSM900 Mode (f = 880 to 915 MHz and P <sub>IN</sub> = 0 to 6 dBm)						
Parameter	Symbol	Test Condition	Minimum	Typical	Maximum	Units
Frequency range	f	—	880	—	915	MHz
Input power	P <sub>IN</sub>	—	0	—	6	dBm
Analog power control voltage	V <sub>APC</sub>	—	0.2	—	1.7	V
Power Added Efficiency	PAE	V <sub>CC</sub> = 3.5 V P <sub>OUT</sub> = 34.5 dBm ENABLE > 2.0 V pulse width 577 μs duty cycle 1:8 T <sub>CASE</sub> = +25 °C	48	56	—	%
2nd to 13th harmonics	2f <sub>0</sub> to 13f <sub>0</sub>	BW = 3 MHz 6.5 dBm ≤ P <sub>OUT</sub> ≤ 34.5 dBm T <sub>CASE</sub> = +25 °C	—	—	-10	dBm
	7F <sub>0</sub>		—	—	-5	
Output power	P <sub>OUT_MAX</sub>	V <sub>CC</sub> = 3.5 V T <sub>CASE</sub> = +25 °C	34.5	35.2	—	dBm
	P <sub>OUT_MAX</sub> LOW VOLTAGE	V <sub>CC</sub> = 2.9 V ENABLE > 2.0 V T <sub>CASE</sub> = -20 °C to +100 °C (See Table 2 for multi-slot.) P <sub>IN</sub> = 0 dBm	32.5	—	—	
	P <sub>OUT_MAX</sub> HIGH VOLTAGE	V <sub>CC</sub> = 4.5 V ENABLE > 2.0 V T <sub>CASE</sub> = -20 °C to +100 °C (See Table 2 for multi-slot.) P <sub>IN</sub> = 0 dBm	32.5	—	—	
Input VSWR	Γ <sub>IN</sub>	P <sub>OUT</sub> = 6.5 to 34.5 dBm, controlled by V <sub>APC</sub>	—	1.5:1	2.5:1	—
Forward isolation	P <sub>OUT_STANDBY</sub>	P <sub>IN</sub> = 6 dBm V <sub>APC</sub> = 0.1 V ENABLE ≤ 0.2 V	—	—	-35	dBm
Spurious	Spur	All combinations of the following parameters: V <sub>APC</sub> = controlled <sup>2</sup> P <sub>IN</sub> = min. to max. V <sub>CC</sub> = 2.9 V to 4.8 V Load VSWR = 8:1, all phase angles	No parasitic oscillation > -36 dBm			

**Table 3. SKY77318 Electrical Specifications<sup>1</sup> (5 of 9)**

GSM900 Mode (f = 880 to 915 MHz and P <sub>IN</sub> = 0 to 6 dBm) [continued]						
Parameter	Symbol	Test Condition	Minimum	Typical	Maximum	Units
Load mismatch	Load	All combinations of the following parameters: V <sub>APC</sub> = controlled <sup>2</sup> P <sub>IN</sub> = min. to max. V <sub>CC</sub> = 2.9 V to 4.8 V Load VSWR = 10:1, all phase angles	No module damage or permanent degradation			
Noise power	P <sub>NOISE</sub>	At f <sub>o</sub> + 20 MHz RBW = 100 kHz V <sub>CC</sub> = 3.5 V 6.5 dBm ≤ P <sub>OUT</sub> ≤ 34.75 dBm T <sub>CASE</sub> = +25 °C	—	—	-81	dBm
		At f <sub>o</sub> + 10 MHz RBW = 100 kHz V <sub>CC</sub> = 3.5 V 6.5 dBm ≤ P <sub>OUT</sub> ≤ 34.75 dBm T <sub>CASE</sub> = +25 °C	—	—	-76	
		At 1805 to 1880 MHz RBW = 100 kHz V <sub>CC</sub> = 3.5 V 6.5 dBm ≤ P <sub>OUT</sub> ≤ 34.75 dBm T <sub>CASE</sub> = +25 °C	—	—	-84	
Coupling of Fundamental, 2nd, and 3rd harmonics from the GSM band into the DCS/PCS band	f <sub>o</sub>	Measured at the DCS/PCS output, -15 dBm ≤ P <sub>OUT</sub> ≤ 34.75 dBm V <sub>CC</sub> = 3.5 V T <sub>CASE</sub> = +25 °C	—	—	3	dBm
	2f <sub>o</sub>		—	—	-16	
	3f <sub>o</sub>		—	—	-17	
Power control dynamic range	P <sub>CDR</sub>	—	30	50	—	dB
Power control variation <sup>4</sup> (Control level 5–15) 3.2 ≤ V <sub>CC</sub> ≤ 4.5	P <sub>CV</sub>	P <sub>OUT</sub> = 14.5 to +34.75 dBm, +25 °C	-0.8	—	0.8	dB
Power control variation <sup>4</sup> (Control level 16–19)		P <sub>OUT</sub> = 14.5 to +34.75 dBm	-1.3	—	1.3	
Power control variation <sup>4</sup> (Control level 16–19)	P <sub>CV</sub>	P <sub>OUT</sub> = 6.5 to +12.5 dBm, +25 °C	-1.1	—	1.1	dB
		P <sub>OUT</sub> = 6.5 to +12.5 dBm	-1.7	—	1.7	
Power control slope	P <sub>CS</sub>	6.5 to 34.75 dBm	—	—	150	dB/V

**Table 3. SKY77318 Electrical Specifications<sup>1</sup> (6 of 9)**

DCS1800 Mode (f = 1710 to 1785 MHz and P <sub>IN</sub> = 0 to 6 dBm)						
Parameter	Symbol	Test Condition	Minimum	Typical	Maximum	Units
Frequency range	f	—	1710	—	1785	MHz
Input power	P <sub>IN</sub>	—	0	—	6	dBm
Analog power control voltage	V <sub>APC</sub>	—	0.2	—	1.7	V
Power Added Efficiency	PAE	V <sub>CC</sub> = 3.5 V P <sub>OUT</sub> = 32.8 dBm ENABLE > 2.0 V pulse width 577 μs duty cycle 1:8 T <sub>CASE</sub> = +25 °C	48	52	—	%
2nd to 7th harmonics	2f <sub>0</sub> to 7f <sub>0</sub>	BW = 3 MHz 1.5 dBm ≤ P <sub>OUT</sub> ≤ 32.8 dBm V <sub>CC</sub> = 3.5 V T <sub>CASE</sub> = +25 °C	—	—	-10	dBm
Output power	P <sub>OUT_MAX</sub>	V <sub>CC</sub> = 3.5 V T <sub>CASE</sub> = +25 °C	32.8	33.5	—	dBm
	P <sub>OUT_MAX</sub> LOW VOLTAGE	V <sub>CC</sub> = 2.9 V ENABLE > 2.0 V T <sub>CASE</sub> = -20 °C to +100 °C (See Table 2 for multi-slot.) P <sub>IN</sub> = 0 dBm	30.0	—	—	
	P <sub>OUT_MAX</sub> HIGH VOLTAGE	V <sub>CC</sub> = 4.5 V ENABLE > 2.0 V T <sub>CASE</sub> = -20 °C to +100 °C (See Table 2 for multi-slot.) P <sub>IN</sub> = 0 dBm	30.0	—	—	
Input VSWR	Γ <sub>IN</sub>	P <sub>OUT</sub> = 1.5 to 32.8 dBm, controlled by V <sub>APC</sub>	—	1.5:1	2.5:1	—
Forward isolation	P <sub>OUT_STANDBY</sub>	P <sub>IN</sub> = 6 dBm V <sub>APC</sub> = 0.1 V ENABLE ≤ 0.2 V	—	—	-35	dBm
Spurious	Spur	All combinations of the following parameters: V <sub>APC</sub> = controlled <sup>3</sup> P <sub>IN</sub> = min. to max. V <sub>CC</sub> = 2.9 V to 4.8 V Load VSWR = 8:1, all phase angles	No parasitic oscillation > -36 dBm			

**Table 3. SKY77318 Electrical Specifications<sup>1</sup> (7 of 9)**

DCS1800 Mode (f = 1710 to 1785 MHz and P <sub>IN</sub> = 0 to 6 dBm) [continued]							
Parameter	Symbol	Test Condition	Minimum	Typical	Maximum	Units	
Load mismatch	Load	All combinations of the following parameters: V <sub>APC</sub> = controlled <sup>3</sup> P <sub>IN</sub> = min. to max. V <sub>CC</sub> = 2.9 V to 4.8 V Load VSWR = 10:1, all phase angles	No module damage or permanent degradation				
Noise power	P <sub>NOISE</sub>	At f <sub>o</sub> + 20 MHz RBW = 100 kHz V <sub>CC</sub> = 3.5 V 1.5 dBm ≤ P <sub>OUT</sub> ≤ 32.8 dBm T <sub>CASE</sub> = +25 °C	—	—	-78	dBm	
		At 925 to 960 MHz RBW = 100 kHz V <sub>CC</sub> = 3.5 V 1.5 dBm ≤ P <sub>OUT</sub> ≤ 32.8 dBm T <sub>CASE</sub> = +25 °C	—	—	-87		
Power control dynamic range	P <sub>CDR</sub>	—	35	50	—	dB	
Power control variation <sup>4</sup> (Control level 0–8) 3.2 V ≤ V <sub>CC</sub> ≤ 4.5 V	P <sub>CV</sub>	P <sub>OUT</sub> = 15.5 to +32.8 dBm, +25 °C	-1.1	—	1.1	dB	
		P <sub>OUT</sub> = 15.5 to +32.8 dBm	-2.0	—	1.2		
Power control variation <sup>4</sup> (Control level 9–13)		P <sub>OUT</sub> = 5.5 to +13.5 dBm, +25 °C	-1.1	—	1.1		
		P <sub>OUT</sub> = 5.5 to +13.5 dBm	-3.4	—	1.4		
Power control variation <sup>4</sup> (Control level 14–15)		P <sub>OUT</sub> = 1.5 to +3.5 dBm, +25 °C	-1.4	—	0.8		
		P <sub>OUT</sub> = 1.5 to +3.5 dBm	-4.0	—	2.0		
Power control slope	P <sub>CS</sub>	1.5 to 32.8 dBm	—	—	150	dB/V	



**Table 3. SKY77318 Electrical Specifications<sup>1</sup> (8 of 9)**

PCS1900 Mode (f = 1850 to 1910 MHz and P <sub>IN</sub> = 0 to 6 dBm)						
Parameter	Symbol	Test Condition	Minimum	Typical	Maximum	Units
Frequency range	F	—	1850	—	1910	MHz
Input power	P <sub>IN</sub>	—	0	—	6	dBm
Analog power control voltage	V <sub>APC</sub>	—	0.2	—	1.7	V
Power Added Efficiency	PAE	V <sub>CC</sub> = 3.5 V P <sub>OUT</sub> = 32.8 dBm ENABLE > 2.0 V pulse width 577 μs duty cycle 1:8 T <sub>CASE</sub> = +25 °C	48	52	—	%
2nd to 7th harmonics	2f <sub>0</sub> to 7f <sub>0</sub>	BW = 3 MHz 1.5 dBm ≤ P <sub>OUT</sub> ≤ 32.8 dBm	—	—	-10	dBm
	5f <sub>0</sub>	V <sub>CC</sub> = 3.5 V T <sub>CASE</sub> = +25 °C	—	—	-7	
Output power	P <sub>OUT_MAX</sub>	V <sub>CC</sub> = 3.5 V T <sub>CASE</sub> = +25 °C	32.8	33.5	—	dBm
	P <sub>OUT_MAX</sub> LOW VOLTAGE	V <sub>CC</sub> = 2.9 V ENABLE > 2.0 V T <sub>CASE</sub> = -20 °C to +100 °C (See Table 2 for multi-slot.) P <sub>IN</sub> = 0 dBm	30.0	—	—	
	P <sub>OUT_MAX</sub> HIGH VOLTAGE	V <sub>CC</sub> = 4.5 V ENABLE > 2.0 V T <sub>CASE</sub> = -20 °C to +100 °C (See Table 2 for multi-slot.) P <sub>IN</sub> = 0 dBm	30.0	—	—	
Input VSWR	Γ <sub>IN</sub>	P <sub>OUT</sub> = 1.5 to 32.8 dBm, controlled by V <sub>APC</sub>	—	1.5:1	2.5:1	—
Forward isolation	P <sub>OUT_STANDBY</sub>	P <sub>IN</sub> = 6 dBm V <sub>APC</sub> = 0.1 V ENABLE ≤ 0.2 V	—	—	-35	dBm
Spurious	Spur	All combinations of the following parameters: V <sub>APC</sub> = controlled <sup>3</sup> P <sub>IN</sub> = min. to max. V <sub>CC</sub> = 2.9 V to 4.8 V Load VSWR = 8:1, phase angles	No parasitic oscillation > -36 dBm			

Table 3. SKY77318 Electrical Specifications<sup>1</sup> (9 of 9)

PCS1900 Mode (f = 1850 to 1910 MHz and P <sub>IN</sub> = 0 to 6 dBm) [continued]						
Parameter	Symbol	Test Condition	Minimum	Typical	Maximum	Units
Load mismatch	Load	All combinations of the following parameters: V <sub>APC</sub> = controlled <sup>3</sup> P <sub>IN</sub> = min. to max. V <sub>CC</sub> = 2.9 V to 4.8 V Load VSWR = 10:1, all phase angles	No module damage or permanent degradation			
Noise power	P <sub>NOISE</sub>	At f <sub>o</sub> + 20 MHz RBW = 100 kHz V <sub>CC</sub> = 3.5 V 1.5 dBm ≤ P <sub>OUT</sub> ≤ 32.8 dBm T <sub>CASE</sub> = +25 °C	—	—	-78	dBm
		At 880 to 915 MHz RBW = 100 kHz V <sub>CC</sub> = 3.5 V 1.5 dBm ≤ P <sub>OUT</sub> ≤ 32.8 dBm T <sub>CASE</sub> = +25 °C	—	—	-87	
Power control dynamic range	P <sub>CDR</sub>	—	35	50	—	dB
Power control variation <sup>4</sup> (Control level 0–8) 3.2 V ≤ V <sub>CC</sub> ≤ 4.5 V	P <sub>CV</sub>	P <sub>OUT</sub> = 15.5 to +32.8 dBm, +25 °C	-1.1	—	1.1	dB
		P <sub>OUT</sub> = 15.5 to +32.8 dBm	-2.0	—	1.2	
Power control variation <sup>4</sup> (Control level 9–13)	P <sub>CV</sub>	P <sub>OUT</sub> = 5.5 to +13.5 dBm, +25 °C	-1.1	—	1.1	dB
		P <sub>OUT</sub> = 5.5 to +13.5 dBm	-3.4	—	1.4	
Power control variation <sup>4</sup> (Control level 14–15)	P <sub>CV</sub>	P <sub>OUT</sub> = 1.5 to +3.5 dBm, +25 °C	-1.4	—	0.8	dB
		P <sub>OUT</sub> = 1.5 to +3.5 dBm	-4.0	—	2.0	
Power control slope	P <sub>CS</sub>	1.5 to 32.8 dBm	—	—	150	dB/V

<sup>1</sup> Unless specified otherwise:

T<sub>CASE</sub> = -20 °C to max. operating temperature (see Table 2)

RL = 50 Ω

pulsed operation with pulse width ≤ 1154 μs and duty cycle ≤ 2:8

V<sub>CC</sub> = 2.9 V to 4.8 V.

<sup>2</sup> I<sub>CC</sub> = 0A to xA, where x = current at P<sub>OUT</sub> = 34.75 dBm for Cell and 34.5 dBm for GSM, 50 Ω load, and V<sub>CC</sub> = 3.5 V.

<sup>3</sup> I<sub>CC</sub> = 0A to xA, where x = current at P<sub>OUT</sub> = 32.8 dBm, 50 Ω load, and V<sub>CC</sub> = 3.5 V.

<sup>4</sup> Power control variation is measured by comparing power obtained at a specified control voltage over all conditions, against the power obtained with the same control voltage at nominal conditions. For this module, nominal conditions are defined as:

T = 25 °C

V<sub>CC</sub> = 3.5 V

P<sub>IN</sub> = 3 dBm

Frequency = mid-band

Place 0402 and 33  $\mu$ F caps as close as possible to the VBATT pin with the 0402 closer to the pin.

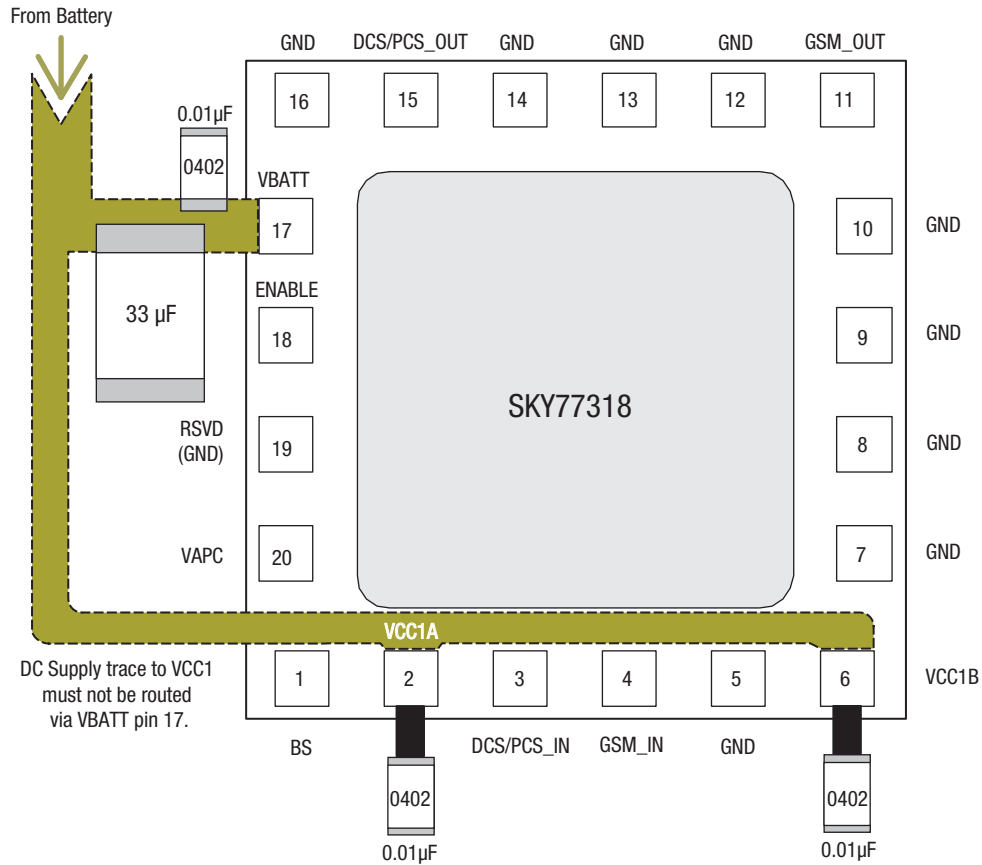

NOTES:

1. The value of 33  $\mu$ F cap depends on the noise level on the phone board.
2. Depending on phone board noise level, not all 0402 and 0.01  $\mu$ F caps may be needed.
3. Ensure sufficient numbers of vias connect VBATT pin to battery trace.
4. VBATT trace should be  $\geq 1.0$  mm.
5. Ensure sufficient numbers of vias connect VCC1A and B to battery trace.
6. VCC1A and VCC1B trace widths should be  $\geq 0.25$  mm.
7. Ground terminals of all bypass caps are connected to ground plane with vias.
8. Dotted traces can be routed in the inner layers.

200424\_002

Figure 2. Typical SKY77318 PAM Application

**Package Dimensions and Pad Description**

Figure 3 is a mechanical diagram of the pad layout for the SKY77318, a 20-pad leadless Quad-Band PA module. Figure 4 provides a recommended phone board layout footprint for the PAM to help the designer attain optimum thermal conductivity, good grounding, and minimum RF discontinuity for the 50 ohm terminals.

Figure 5 shows the device pad configuration and Table 4 lists the pad names and signal descriptions. The pad numbering convention starts with pad 1 at the upper left, as indicated in Figure 5, and increments counter-clockwise around the package. Figure 6 interprets typical case markings.

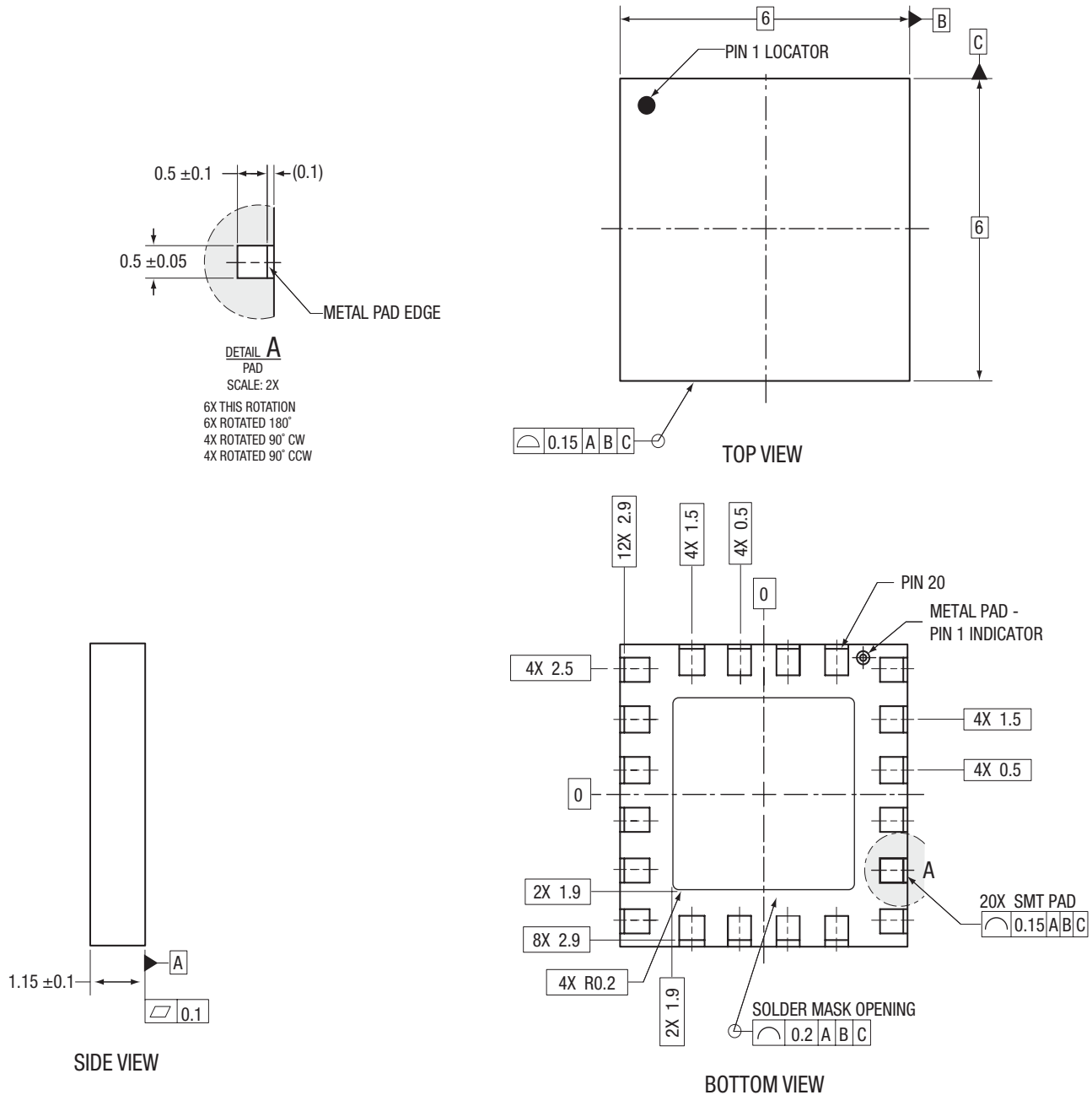

- NOTES: UNLESS OTHERWISE SPECIFIED.
1. DIMENSIONING AND TOLERANCING IN ACCORDANCE WITH ASME Y14.5M-1994.
  2. ALL DIMENSIONS ARE IN MILLIMETERS.
  3. PADS ARE SOLDER MASK DEFINED ON ALL THREE EDGES AND METAL DEFINED ON ONE EDGE.

**Figure 3. SKY77318 PAM Package Dimensions—20-Pad Leadless (All Views)**

103237\_003

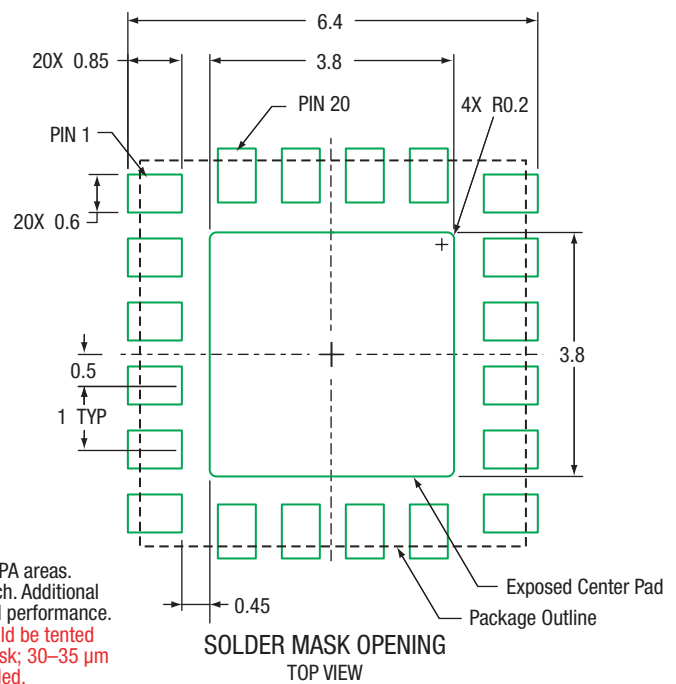
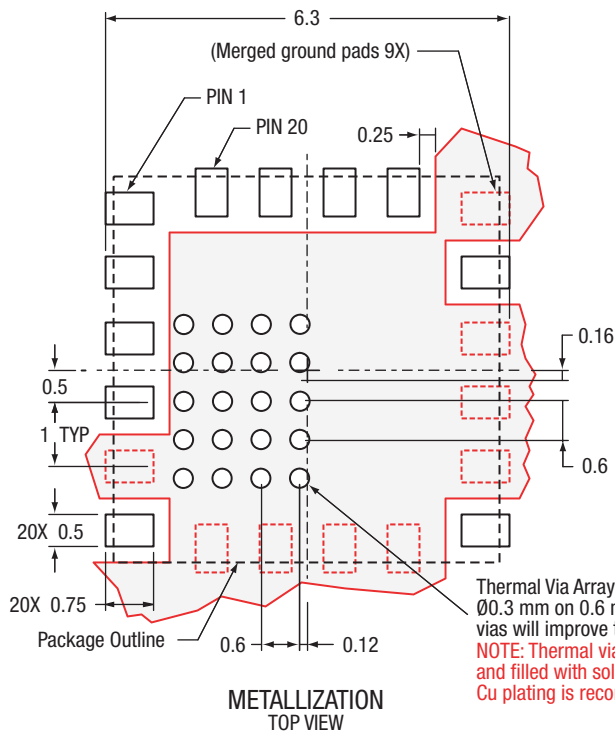
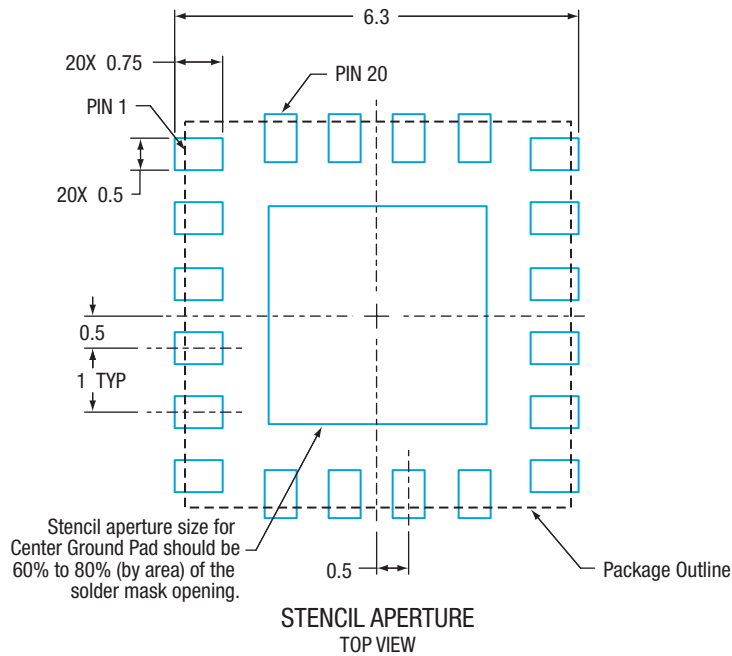

The shaded area represents the merger of the Center Ground Pad and 9 individual I/O ground pads. The outlines of these pads are shown for reference.

ALL DIMENSIONS ARE IN MILLIMETERS.

200424\_004

Figure 4. Phone Board Layout Footprint for 6 x 6 mm, 20-Pad Package – SKY77318

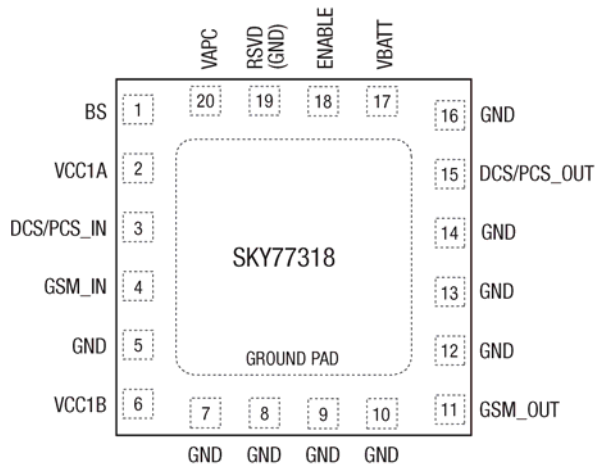

Pad layout as seen from top view looking through the package.

200424\_005

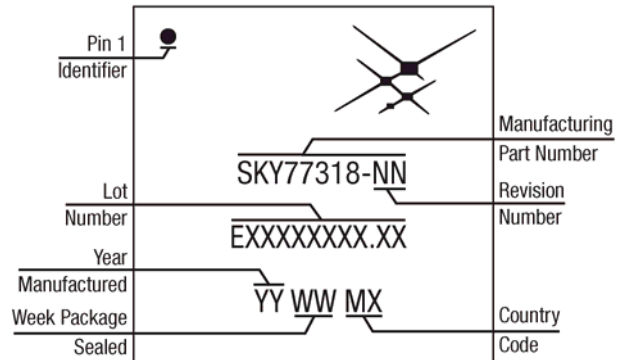

200424\_006

Figure 5. SKY77318 PAM Pad Configuration—20-Pad Leadless (Top View)

Figure 6. Typical Case Markings

Table 4. SKY77318 Pad Names and Signal Descriptions

Pad	Name	Description
1	BS	Band Select
2	VCC1A	VCC (to GSM 1st stage, DCS/PCS 1st stages, BiCMOS PAC)
3	DCS/PCS_IN	RF input 1710–1910 MHz (DCS1800, PCS1900)
4	GSM_IN	RF input 880–915 MHz (GSM)
5	GND	RF and DC Ground
6	VCC1B	VCC (to GSM 2nd stage, DCS/PCS 2nd stages)
7	GND	RF and DC Ground
8	GND	RF and DC Ground
9	GND	RF and DC Ground
10	GND	RF and DC Ground
11	GSM_OUT	RF Output 880–915 MHz (GSM)
12	GND	RF and DC Ground
13	GND	RF and DC Ground
14	GND	RF and DC Ground
15	DCS/PCS_OUT	RF Output 1710–1910 MHz (DCS1800, PCS1900)
16	GND	RF and DC Ground
17	VBATT	Battery input to high side of internal sense resistor
18	ENABLE	BiCMOS Enable
19	RSVD(GND)	RF and DC Ground
20	VAPC	Power Control Bias Voltage
GND PAD	GND	Ground Pad, device underside

## Package and Handling Information

Because of its sensitivity to moisture absorption, this device package is baked and vacuum-packed prior to shipment. Instructions on the shipping container label must be followed regarding exposure to moisture after the container seal is broken, otherwise, problems related to moisture absorption may occur when the part is subjected to high temperature during solder assembly.

The SKY77318 is capable of withstanding an MSL3/260 °C solder reflow. Care must be taken when attaching this product, whether it is done manually or in a production solder reflow environment. If the part is attached in a reflow oven, the temperature ramp rate should not exceed 3 °C per second; maximum temperature should not exceed 260 °C. If the part is manually attached, precaution should be taken to insure that the part is not subjected to temperatures exceeding 260 °C for more than 10 seconds. For details on attachment techniques, precautions, and handling procedures recommended by Skyworks, please refer to Skyworks Application Note: *PCB Design and SMT Assembly/Rework*, Document Number 101752. Additional information on standard SMT reflow profiles can also be found in the *JEDEC Standard J-STD-020*.

- Personnel Grounding
  - Wrist Straps
  - Conductive Smocks, Gloves and Finger Cots
  - Antistatic ID Badges
- Protective Workstation
  - Dissipative Table Top
  - Protective Test Equipment (Properly Grounded)
  - Grounded Tip Soldering Irons
  - Solder Conductive Suckers
  - Static Sensors

Production quantities of this product are shipped in the standard tape-and-reel format. For packaging details, refer to Skyworks Application Note: *Tape and Reel – RF Modules*, Document Number 101568.

## Electrostatic Discharge Sensitivity

The SKY77318 has been classified as a Human Body Model Class 1C (1000 volts to < 2000 volts) and Machine Model Class M2 (100 volts to < 200 volts) device. ESD testing has been performed in compliance to the latest JEDEC Human Body Model specification, HBM (JESD22-A114-B) and Machine Model specification, (JESD22-A115-A). A report summarizing the ESD testing, including ESD failure level thresholds on each pad-to-ground and pad-to-pad combination, may be obtained upon request.

To avoid ESD damage, both latent and visible, it is very important that the product assembly and test areas follow the Class-1 ESD handling precautions listed below.

- Facility
  - Relative Humidity Control and Air Ionizers
  - Dissipative Floors (less than  $10^9 \Omega$  to GND)
- Protective Packaging and Transportation
  - Bags and Pouches (Faraday Shield)
  - Protective Tote Boxes (Conductive Static Shielding)
  - Protective Trays
  - Grounded Carts
  - Protective Work Order Holders

## Technical Information

Closed loop control of the amplifier is enabled when ENABLE is driven to logic high. The PA collector current will then be directly proportional to the  $V_{APC}$  input voltage over the range of 200 mV to 2.1 V.

To meet the GSM power versus time mask and switching transient requirements the PAM must be provided with a DAC ramp profile on the  $V_{APC}$  input as well as proper timing on digital controls for the PAC circuitry.

**Note:** *Please refer to 3GPP TS 51.010-1: Mobile Station (MS) conformance specification. All GSM specifications are now the responsibility of 3GPP. The standards are available at <http://www.3gpp.org>.*

The SKY77318 has been designed to comply with interface requirements and DAC resolution of leading base band devices. The ramp profile typically consists of a pedestal voltage, 10 to 16 discrete voltage steps on the rising edge of the burst, a constant region, 10 to 16 steps on the falling edge, and a final voltage. Typically, the user defines the start, stop, and 10 to 16 percentage values for each rising and falling edge, which are then applied as discrete voltages at the  $V_{APC}$  input. For the SKY77318, generally the same profile, scaled in amplitude, is used for all frequencies and power control levels. The ultimate purpose is to keep the RF output power ramp within the time mask and to maintain

acceptable spectral limits at specified offset frequencies. The  $V_{APC}$  input has an internal reconstruction filter such that external resistors or capacitors are unnecessary on the phone board or the test fixture.

Figure 7 represents the dynamic characteristics of the RF output burst power that results from the ramp profile delivered by the DAC to the  $V_{APC}$  input. The transmit power must not exceed the given limits at the time specified relative to the start and end of the data burst. Additional requirements are placed on spectral components generated by switching transients. Ramping at high rates will result in components that violate these spectral limits. A ramp control signal must be applied to the  $V_{APC}$  pad, which results in the desired power ramp response. The log relationship of  $V_{APC}$  to  $P_{OUT}$ , along with the finite bandwidth and potential slew rate limitations of the feedback loop, results in a complex mapping of the ramp profile to the actual output power. Careful attention is required in generating the input waveform which results in the desired output response.

Figure 8 shows an example of the Skyworks PAM test setup for evaluation of RF performance with various ramp profiles. The user's test setup may also include a TX/RX switch and a diplexer in the output signal path. Alternatively, the SKY77318 PAM may be installed in a phone board.



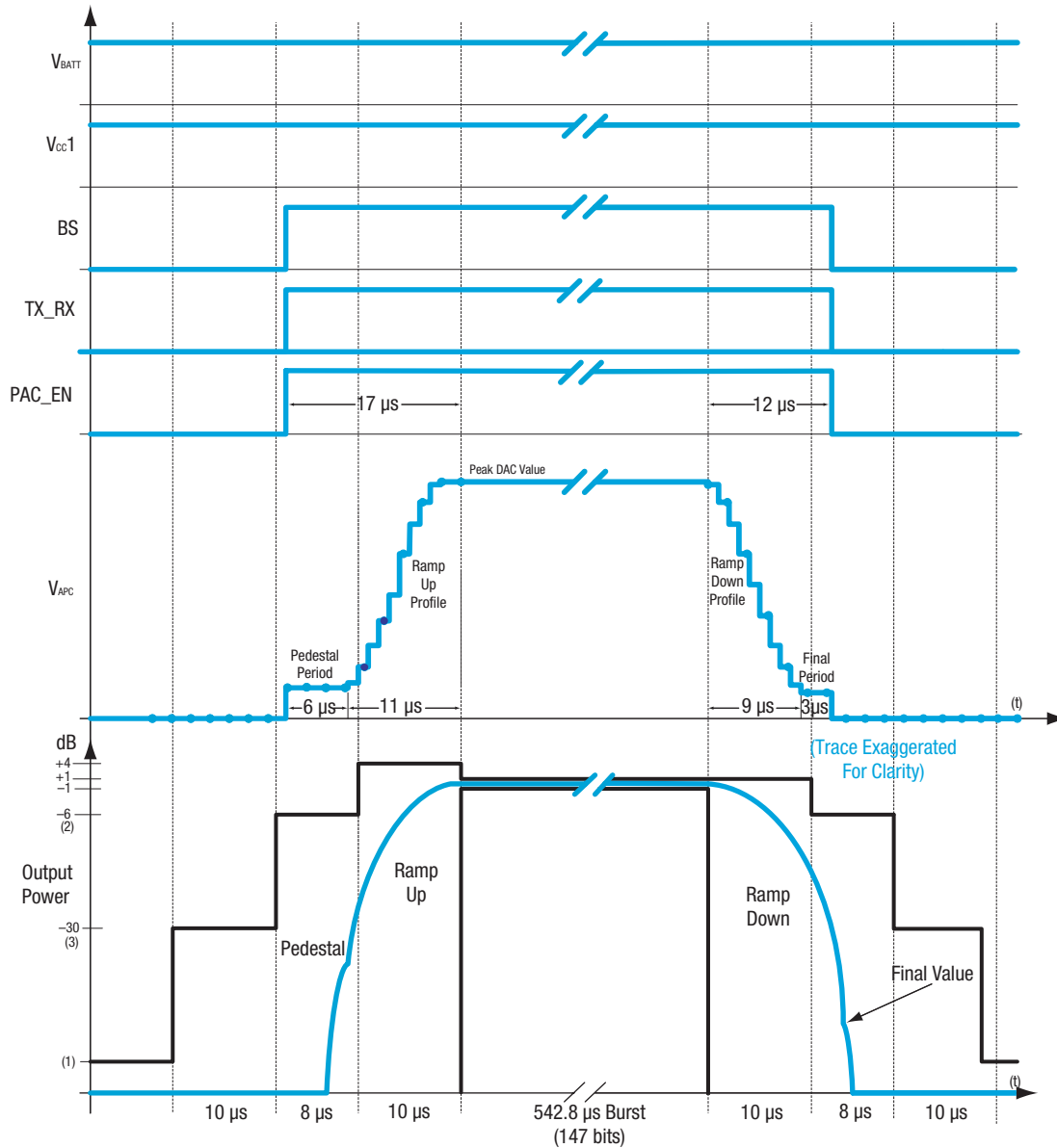

(1)	For GSM	-59 dBc or -36 dBm, whichever is higher.
	For DCS1800 / PCS1900	-48 dBc or -48 dBm, whichever is higher.
(2)	For GSM	-4 dBc for power control level 16, -2 dBc for power control level 17, -1 dBc for power control level 18 and 19.
	For DCS1800 / PCS1900	-4 dBc for power control level 11, -2 dBc for power control level 12, -1 dBc for power control level 13, 14, 15.
(3)	For GSM	-30 dBc or -17 dBm, whichever is higher.
	For DCS1800 / PCS1900	-30 dBc or -20 dBm, whichever is higher.

103237\_008

**Figure 7. Example of PAM Recommended Timing Diagram**

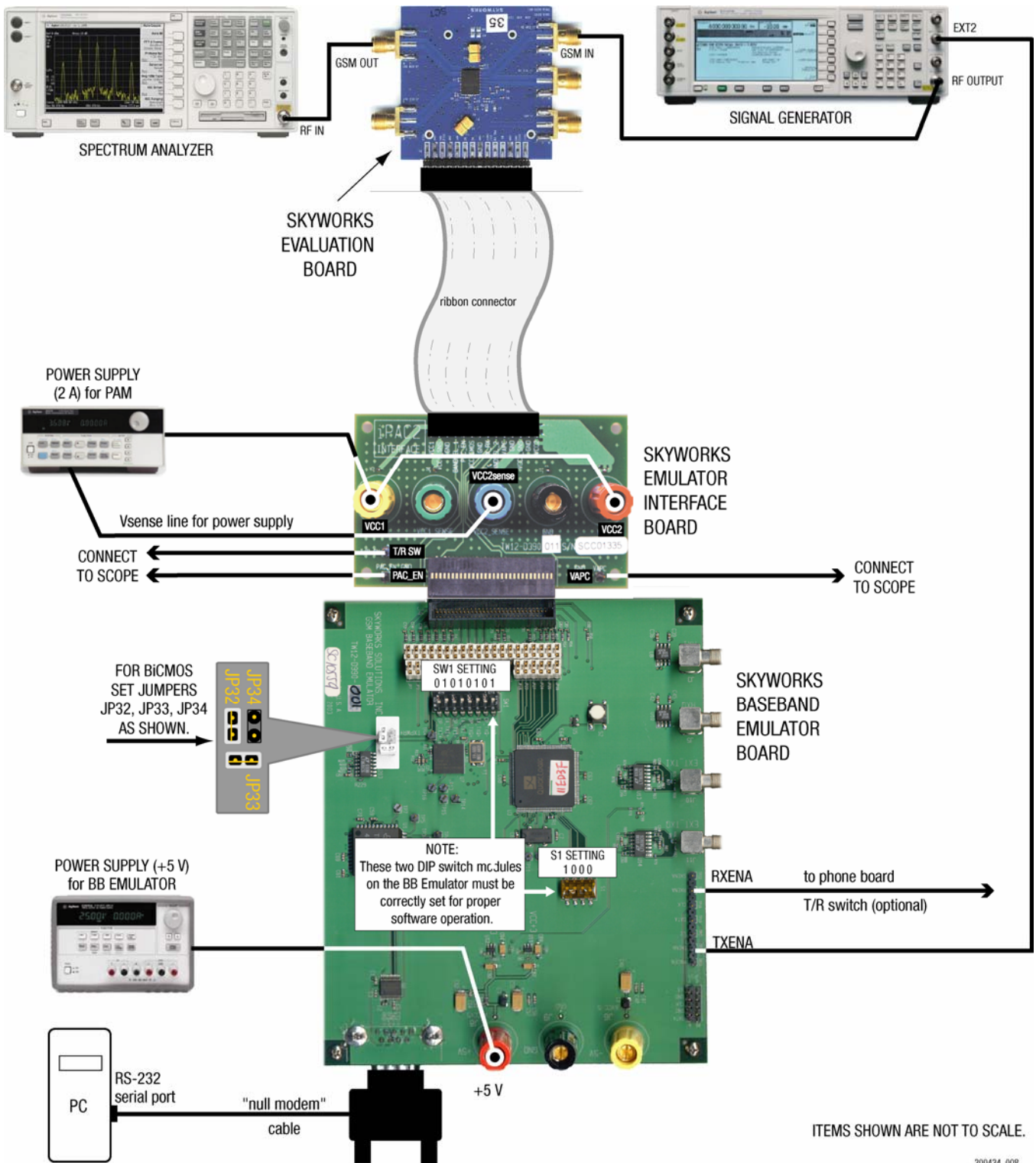

Figure 8. PAM Evaluation Test Setup – BiCMOS.

## Ordering Information

Model Number	Manufacturing Part Number	Product Revision	Package	Operating Temperature
SKY77318	SKY77318		6 x 6 x 1.2 mm	-20 °C to +100 °C

## Revision History

Revision	Level	Date	Description
A		January 31, 2007	Initial Release
B		December 17, 2007	Revise: Table 3 (8 of 9) VAPC

## References

Application Note: Tape and Reel Information – RF Modules, Document Number 101568

Application Note: PCB Design and SMT Assembly/Rework, Document Number 101752

Application Brief: iPAC™ GSM Transmitter Timing, Calibration and Baseband Control, Document Number 103138

Application Note: iPAC™ Peak Output Power Calibration, Document Number 103180

User Guide: iPAC™ Test and Control – Baseband Emulator Interface, Document Number 103125

JEDEC Standard J–STD–020

3GPP TS 51.010-1; Mobile Station (MS) Conformance Specification (<http://www.3gpp.org>)

© 2006–2007, Skyworks Solutions, Inc. All Rights Reserved.

Information in this document is provided in connection with Skyworks Solutions, Inc. ("Skyworks") products. These materials are provided by Skyworks as a service to its customers and may be used for informational purposes only. Skyworks assumes no responsibility for errors or omissions in these materials. Skyworks may make changes to its products, specifications and product descriptions at any time, without notice. Skyworks makes no commitment to update the information and shall have no responsibility whatsoever for conflicts, incompatibilities, or other difficulties arising from future changes to its products and product descriptions.

No license, express or implied, by estoppel or otherwise, to any intellectual property rights is granted by this document. Except as may be provided in Skyworks' Terms and Conditions of Sale for such products, Skyworks assumes no liability whatsoever.

THESE MATERIALS ARE PROVIDED "AS IS" WITHOUT WARRANTY OF ANY KIND, EITHER EXPRESS OR IMPLIED, RELATING TO SALE AND/OR USE OF SKYWORKS™ PRODUCTS INCLUDING WARRANTIES RELATING TO FITNESS FOR A PARTICULAR PURPOSE, MERCHANTABILITY, PERFORMANCE, QUALITY OR NON-INFRINGEMENT OF ANY PATENT, COPYRIGHT OR OTHER INTELLECTUAL PROPERTY RIGHT. SKYWORKS FURTHER DOES NOT WARRANT THE ACCURACY OR COMPLETENESS OF THE INFORMATION, TEXT, GRAPHICS OR OTHER ITEMS CONTAINED WITHIN THESE MATERIALS. SKYWORKS SHALL NOT BE LIABLE FOR ANY SPECIAL, INDIRECT, INCIDENTAL, OR CONSEQUENTIAL DAMAGES, INCLUDING WITHOUT LIMITATION, LOST REVENUES OR LOST PROFITS THAT MAY RESULT FROM THE USE OF THESE MATERIALS.

Skyworks™ products are not intended for use in medical, lifesaving or life-sustaining applications. Skyworks' customers using or selling Skyworks™ products for use in such applications do so at their own risk and agree to fully indemnify Skyworks for any damages resulting from such improper use or sale.

The following are trademarks of Skyworks Solutions, Inc.: Skyworks™, the Skyworks symbol, and "Breakthrough Simplicity"™. Product names or services listed in this publication are for identification purposes only, and may be trademarks of third parties. Third-party brands and names are the property of their respective owners.

Additional information, posted at [www.skyworksinc.com](http://www.skyworksinc.com), is incorporated by reference.