

DATA SHEET

SMV2025 Series: Surface Mount, Silicon Hyperabrupt Tuning Varactor Diodes

Applications

- Wide bandwidth and low phase noise VCOs
- Wide range, voltage-tuned phase shifters and filters
- Miniature RF and microwave tuners

Features

- Low series resistance and leakage current for low phase noise VCOs
- High capacitance ratio: $C_T(2\text{ V})/C_T(10\text{ V}) = 2.2$ minimum
- Broad 18 V tuning range
- Competitive cross to Toshiba 1SV280 varactor diode
- SC-79 and ultra-small SOD-882 packages (MSL1, 260 °C per JEDEC J-STD-020)



Skyworks Pb-free products are compliant with all applicable legislation. For additional information, refer to *Skyworks Definition of Lead (Pb)-Free*, document number SQ04-0073.



Description



The SMV2025 series are silicon surface mount, hyperabrupt tuning varactor diodes, excellent for use as high-Q tuning elements in an RF Voltage Controlled Oscillator (VCO), voltage-controlled phase shifter, or tunable bandpass filter.

The minimum capacitance ratio from 2 V to 10 V is 2.2 makes the SMV2025 series suitable for wide bandwidth VCOs and wide phase range phase shifters.

The SMV2025 is manufactured in a surface mount, industry-standard SC-79 package and an ultra-small SOD-882 package that offer very low parasitic inductance and capacitance.

Table 1 describes the packages and markings of the SMV2025 series diodes.

Table 1. Packaging and Marking

	
Single	Single
SC-79 Green™	SOD-882 Green™
SMV2025-079LF Marking: Cathode	SMV2025-040LF Marking: DK1
$L_s = 0.70\text{ nH}$	$L_s = 0.45\text{ nH}$



The Pb-free symbol or "LF" in the part number denotes a lead-free, RoHS-compliant package unless otherwise noted as Green™. Tin/lead (Sn/Pb) packaging is not recommended for new designs.

Table 1. SMV2025 Series Absolute Maximum Ratings

Parameter	Symbol	Minimum	Maximum	Units
Forward current	I _F		100	mA
Reverse voltage	V _R		20	V
Dissipated power @ 25 °C	P _D		250	mW
Storage temperature	T _{STG}	-55	+200	°C
Junction temperature	T _J	-55	+175	°C
Solder interface temperature	T _S	-40	+85	°C

Note: Exposure to maximum rating conditions for extended periods may reduce device reliability. There is no damage to device with only one parameter set at the limit and all other parameters set at or below their nominal value. Exceeding any of the limits listed here may result in permanent damage to the device.

CAUTION: Although this device is designed to be as robust as possible, Electrostatic Discharge (ESD) can damage this device. This device must be protected at all times from ESD. Static charges may easily produce potentials of several kilovolts on the human body or equipment, which can discharge without detection. Industry-standard ESD precautions should be used at all times. The SMV2025 series are Class 3A devices (Human Body Model).

Table 2. SMV2025 Series Electrical Specifications (Note 1)
(T_s = +25 °C, Characteristic Impedance [Z₀] = 50 Ω, Unless Otherwise Noted)

Parameter	Symbol	Test Condition	Min	Typical	Max	Units
Reverse current	I _R	V _R = 19 V			20	nA
Capacitance	C _T	f = 1 MHz				
		V _R = 2 V	4.20		5.10	pF
		V _R = 10 V	1.60		2.00	pF
		V _R = 18 V	1.00		1.25	pF
Capacitance ratio	C _{TR}	C _T @ 2 V/C _T @ 10 V	2.2			-
Series resistance	R _S	f = 470 MHz, V _R = 1 V		0.8		Ω
Breakdown voltage	V _{BR}	I _R = 10 μA	20			V

Note 1: Performance is guaranteed only under the conditions listed in this Table.

Electrical and Mechanical Specifications

The absolute maximum ratings for the SMV2025 series are provided in Table 1. Electrical specifications are provided in Table 2. Table 3 summarizes the typical capacitance for reverse voltages between 0 and 20 V.

Typical performance characteristics are illustrated in Figures 1 and 2.

The SPICE model for the SMV2025 series of varactor diodes is shown in Figure 3 and the associated model parameters are provided in Table 4.

Package Dimensions

Package dimensions for the SMV2025 series are provided in Figure 4 (SC-79) and Figure 6 (SOD-882). Tape and reel

dimensions are provided in Figure 5 (SC-79) and Figure 7 (SOD-882). For the PCB layout footprint, refer to the Skyworks Application Note, *Suggested PCB Land Pattern Designs for Leaded and Leadless Packages, and Detailed Surface Mount Guidelines for Leadless Packages*, document number 200123.

Package and Handling Information

Instructions on the shipping container label regarding exposure to moisture after the container seal is broken must be followed. Otherwise, problems related to moisture absorption may occur when the part is subjected to high temperature during solder assembly.

The SMV2025 series are rated to Moisture Sensitivity Level 1 (MSL1) at 260 °C. They can be used for lead or lead-free soldering. For additional information, refer to the Skyworks Application Note, *Solder Reflow Information*, document number 200164.

Care must be taken when attaching this product, whether it is done manually or in a production solder reflow environment. Production quantities of this product are shipped in a standard tape and reel format.

Table 3. Reverse Voltage vs Typical Capacitance

V _R (V)	C _T (pF)
0	8.81
0.5	6.93
1.0	5.88
1.5	5.18
2.0	4.67
2.5	4.27
3.0	3.94
3.5	3.67
4.0	3.44
4.5	3.23
5.0	3.05
6.0	2.74
7.0	2.47
8.0	2.24
9.0	2.03
10.0	1.83
11.0	1.65
12.0	1.50
13.0	1.38
14.0	1.30
15.0	1.24
16.0	1.21
17.0	1.19
18.0	1.17
19.0	1.16
20.0	1.15

Typical Performance Characteristics

(TA = 25 °C, Unless Otherwise Noted)

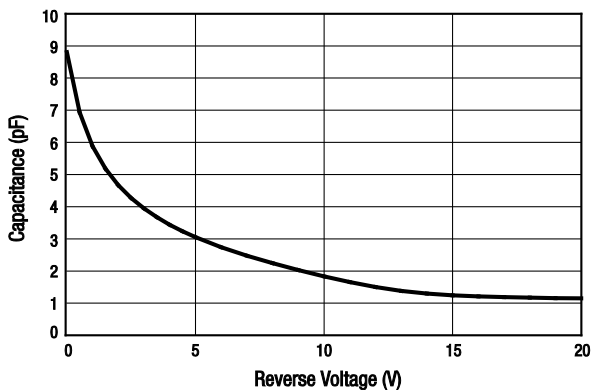

Figure 1. Capacitance vs Reverse Voltage

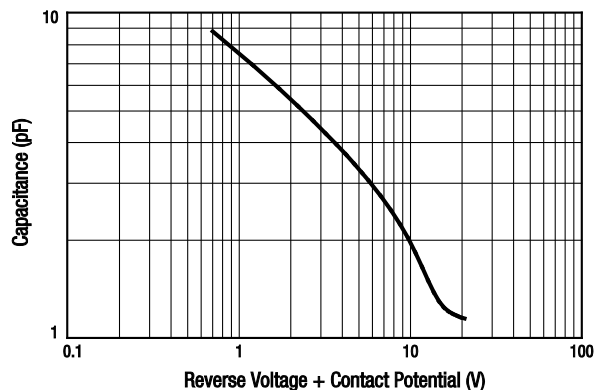

Figure 2. Capacitance vs Reverse Voltage (Logarithmic Plot)

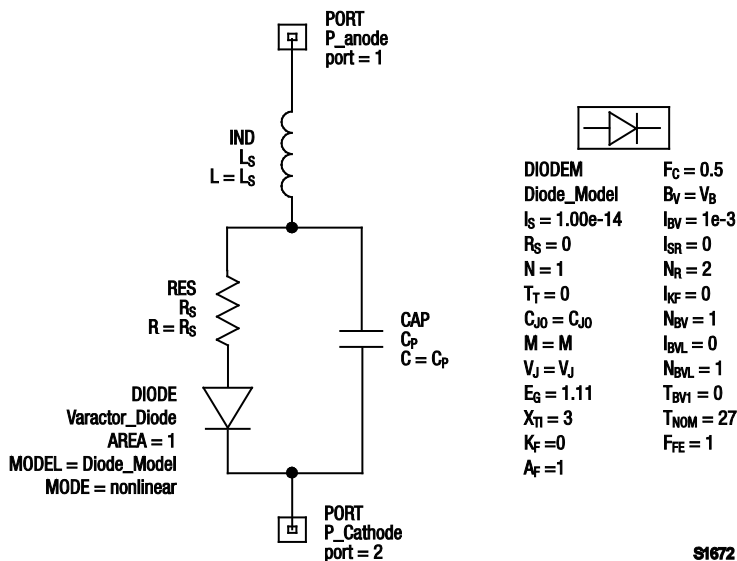
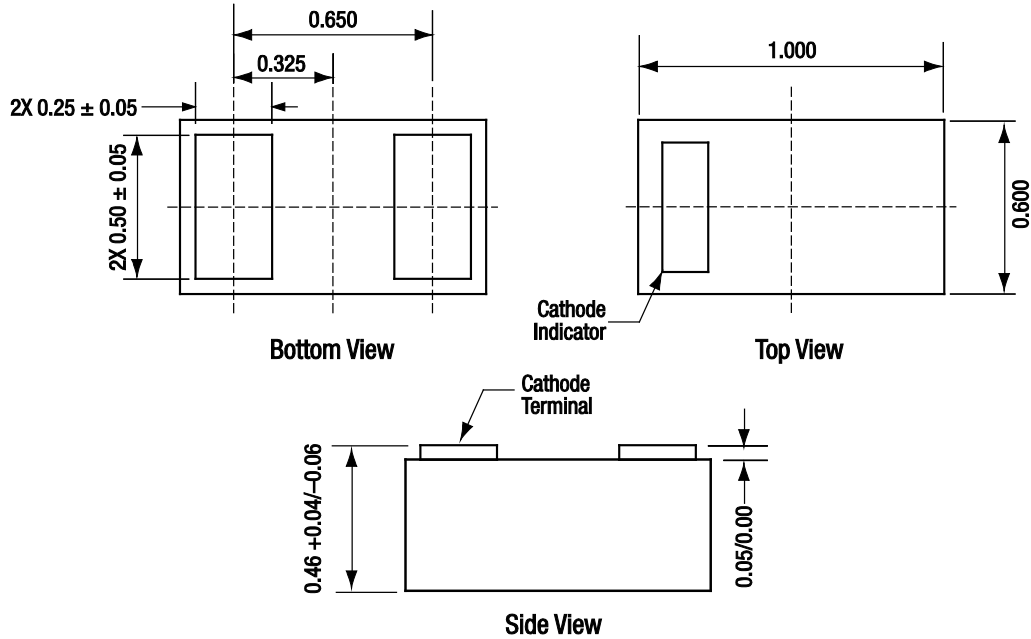

Figure 3. SPICE Model

Table 4. SPICE Model Parameters

Part Number	CJO (pF)	VJ (V)	M	CP (pF)	RS (Ω)	LS (nH)
SMV2025-079LF	8.8	1.05	0.7	0.07	0.8	0.70
SMV2025-040LF	8.8	1.05	0.7	0.07	0.8	0.45



All dimensions in millimeters

S1892

Figure 6. SMV2025-040LF Package Dimensions (SOD-882)

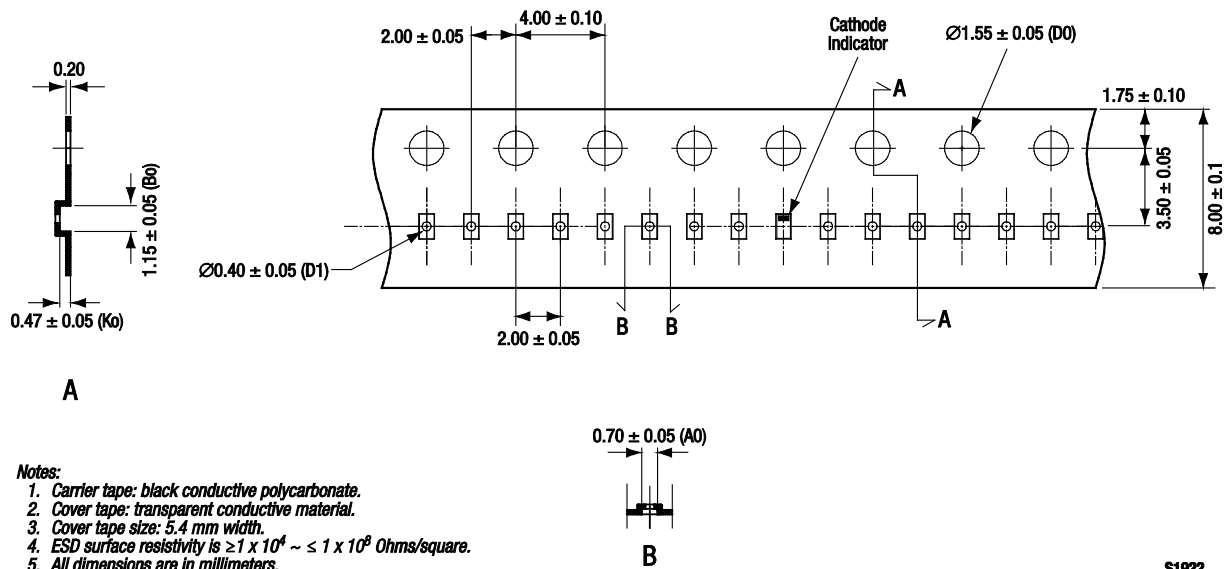

Notes:

1. Carrier tape: black conductive polycarbonate.
2. Cover tape: transparent conductive material.
3. Cover tape size: 5.4 mm width.
4. ESD surface resistivity is $\geq 1 \times 10^8 \sim \leq 1 \times 10^9$ Ohms/square.
5. All dimensions are in millimeters.

S1922

Figure 7. SMV2025-040LF Tape and Reel Dimensions (SC-79)

Ordering Information

Model Name	Manufacturing Part Number
SMV2025 Series Surface Mount Hyperabrupt Tuning Varactor Diode	SMV2025-079LF SMV2025-040LF

Copyright © 2010, 2011, 2012 Skyworks Solutions, Inc. All Rights Reserved.

Information in this document is provided in connection with Skyworks Solutions, Inc. (“Skyworks”) products or services. These materials, including the information contained herein, are provided by Skyworks as a service to its customers and may be used for informational purposes only by the customer. Skyworks assumes no responsibility for errors or omissions in these materials or the information contained herein. Skyworks may change its documentation, products, services, specifications or product descriptions at any time, without notice. Skyworks makes no commitment to update the materials or information and shall have no responsibility whatsoever for conflicts, incompatibilities, or other difficulties arising from any future changes.

No license, whether express, implied, by estoppel or otherwise, is granted to any intellectual property rights by this document. Skyworks assumes no liability for any materials, products or information provided hereunder, including the sale, distribution, reproduction or use of Skyworks products, information or materials, except as may be provided in Skyworks Terms and Conditions of Sale.

THE MATERIALS, PRODUCTS AND INFORMATION ARE PROVIDED “AS IS” WITHOUT WARRANTY OF ANY KIND, WHETHER EXPRESS, IMPLIED, STATUTORY, OR OTHERWISE, INCLUDING FITNESS FOR A PARTICULAR PURPOSE OR USE, MERCHANTABILITY, PERFORMANCE, QUALITY OR NON-INFRINGEMENT OF ANY INTELLECTUAL PROPERTY RIGHT; ALL SUCH WARRANTIES ARE HEREBY EXPRESSLY DISCLAIMED. SKYWORKS DOES NOT WARRANT THE ACCURACY OR COMPLETENESS OF THE INFORMATION, TEXT, GRAPHICS OR OTHER ITEMS CONTAINED WITHIN THESE MATERIALS. SKYWORKS SHALL NOT BE LIABLE FOR ANY DAMAGES, INCLUDING BUT NOT LIMITED TO ANY SPECIAL, INDIRECT, INCIDENTAL, STATUTORY, OR CONSEQUENTIAL DAMAGES, INCLUDING WITHOUT LIMITATION, LOST REVENUES OR LOST PROFITS THAT MAY RESULT FROM THE USE OF THE MATERIALS OR INFORMATION, WHETHER OR NOT THE RECIPIENT OF MATERIALS HAS BEEN ADVISED OF THE POSSIBILITY OF SUCH DAMAGE.

Skyworks products are not intended for use in medical, lifesaving or life-sustaining applications, or other equipment in which the failure of the Skyworks products could lead to personal injury, death, physical or environmental damage. Skyworks customers using or selling Skyworks products for use in such applications do so at their own risk and agree to fully indemnify Skyworks for any damages resulting from such improper use or sale.

Customers are responsible for their products and applications using Skyworks products, which may deviate from published specifications as a result of design defects, errors, or operation of products outside of published parameters or design specifications. Customers should include design and operating safeguards to minimize these and other risks. Skyworks assumes no liability for applications assistance, customer product design, or damage to any equipment resulting from the use of Skyworks products outside of stated published specifications or parameters.

Skyworks, the Skyworks symbol, and “Breakthrough Simplicity” are trademarks or registered trademarks of Skyworks Solutions, Inc., in the United States and other countries. Third-party brands and names are for identification purposes only, and are the property of their respective owners. Additional information, including relevant terms and conditions, posted at www.skyworksinc.com, are incorporated by reference.