

7 A very low drop positive voltage regulator adjustable

Features

- Output current limit
- Low dropout voltage: typically 400 mV at 7 A output current
- Output voltage remote sense pin
- Fast transient response
- Thermal shutdown protection with hysteresis
- Wide operating temperature range -40 °C to 125 °C
- No supply sequencing problems in dual supply mode
- Output voltages available: adjustable

Description

The LD1580 is a very low dropout positive linear voltage regulator particularly suitable in applications requiring output currents up to 7 A.

The LD1580 typical dropout voltage is 400 mV at 7 A while it decreases at lighter loads.

This very low dropout is achieved thanks to a second input voltage pin, named VCONTROL, which is also responsible of the output power stage driving.

The LD1580 is provided with an output voltage remote sense pin which reduces dramatically any output voltage variations that could occur due to load changes.

The ADJ pin is still available. A small capacitor on this pin helps to improve transient response.

The LD1580 also features a built-in output current limit function and a thermal shutdown protection with hysteresis which prevents from excessive

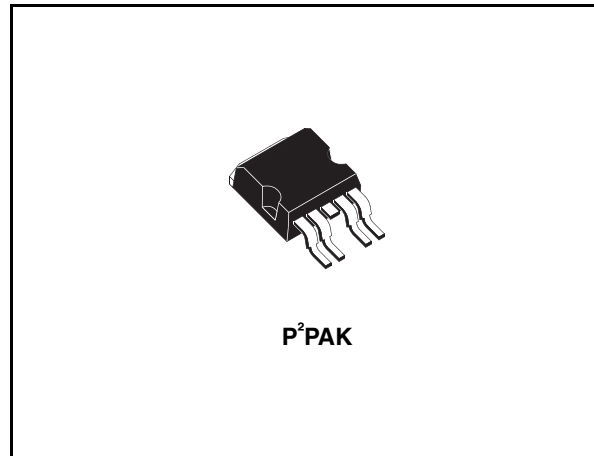

power dissipation in case of insufficient heatsinking. On chip trimming allows the regulator to reach a very tight output voltage tolerance, within $\pm 2\%$ at the maximum output current and over the full temperature range.

Table 1. Device summary

Part number	Order code	Packaging
LD1580XX	LD1580P2T-R	tape and reel

Contents

1	Diagram	3
2	Pin configuration	4
3	Maximum ratings	5
4	Typical application	6
5	Electrical characteristics	7
6	Typical characteristics	8
7	Package mechanical data	11
8	Revision history	14

1 Diagram

Figure 1. Schematic diagram

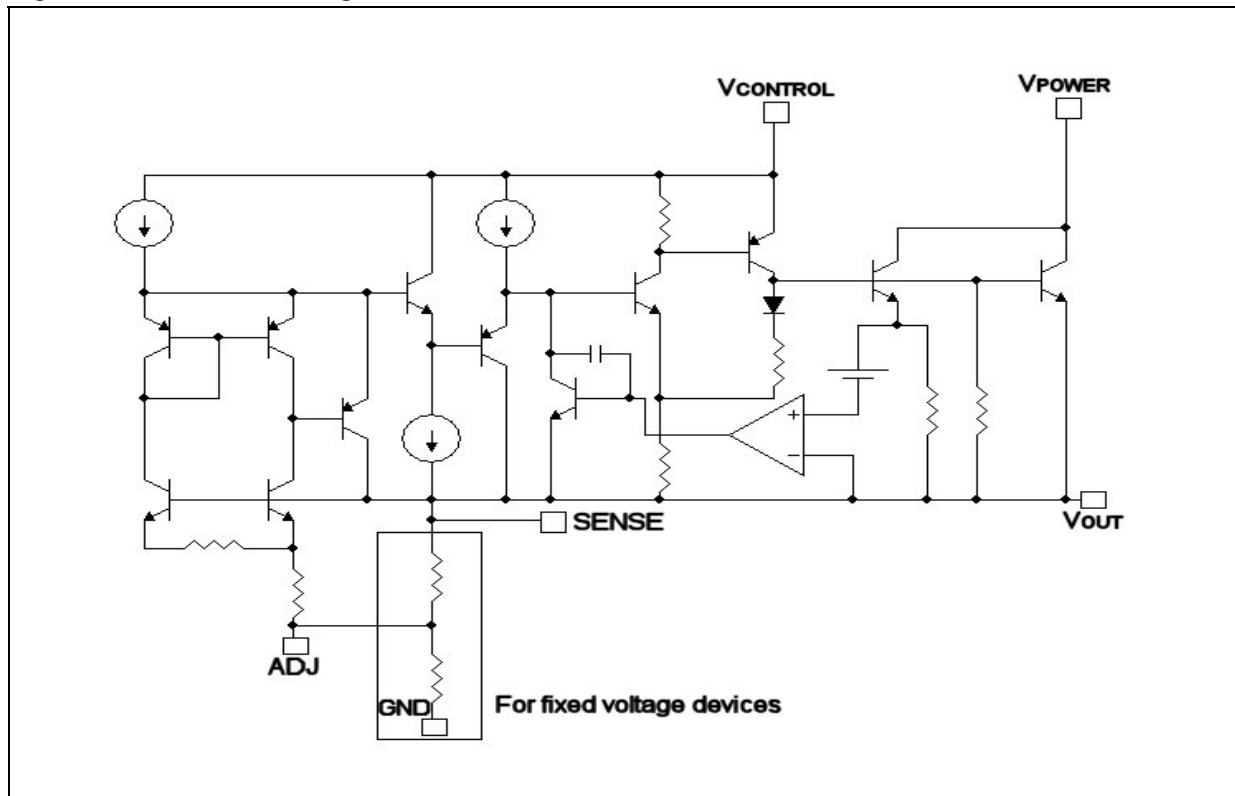

2 Pin configuration

Figure 2. Pin connections (top view)

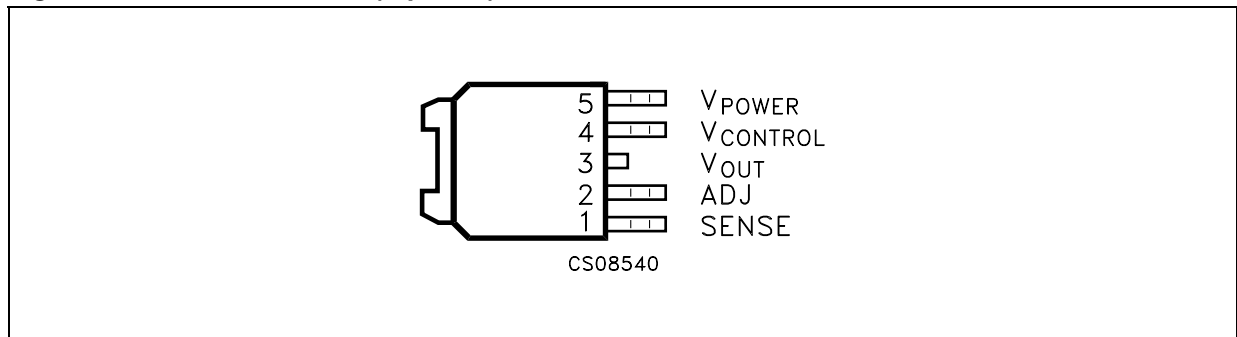

3 Maximum ratings

Table 2. Absolute maximum ratings

Symbol	Parameter	Value	Unit
V _{POWER}	DC V _{POWER} voltage	from -0.3 to 6	V
V _{CONTROL}	DC V _{CONTROL} voltage	from -0.3 to 13	V
I _{OUT}	Output current	Internally limited	
P _D	Power dissipation	Internally limited	
T _{STG}	Storage temperature range	-55 to +150	°C
T _{OP}	Operating junction temperature range	-40 to +125	°C

Note: Absolute maximum ratings are those values beyond which damage to the device may occur. Functional operation under these condition is not implied.

Table 3. Thermal data

Symbol	Parameter	P ² PAK	Unit
R _{thJC}	Thermal resistance junction-case	3	°C/W
R _{thJA}	Thermal resistance junction-ambient	62.5	°C/W

4 Typical application

Figure 3. Typical application circuits

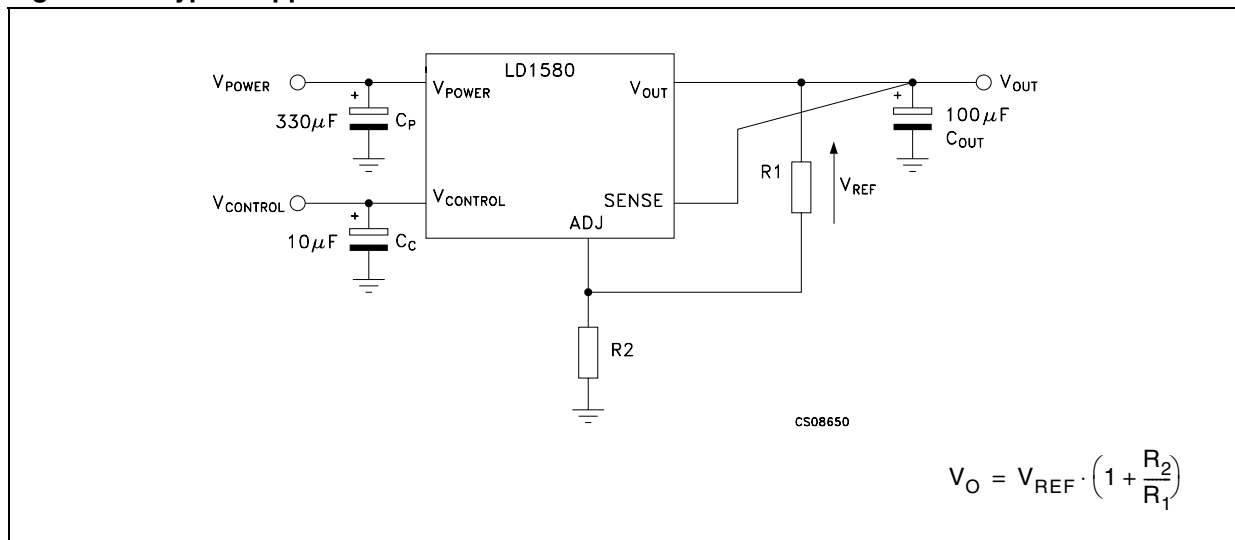

5 Electrical characteristics

Table 4. Electrical characteristics for LD1580 ($T_J = -40\text{ °C}$ to 125 °C , $C_P = 330\text{ }\mu\text{F}$, $C_C = 10\text{ }\mu\text{F}$, $C_{OUT} = 100\text{ }\mu\text{F}$, unless otherwise specified)

Symbol	Parameter	Test conditions	Min.	Typ.	Max.	Unit
V_O	Output voltage	$V_{CONTROL}=2.75\text{ V}$, $V_{POWER}=2\text{ V}$ $T_J=25\text{ °C}$, $I_{OUT}=10\text{ mA}$	1.237	1.250	1.263	V
		$V_{CONTROL}=2.7\text{ V}$ to 12 V $V_{POWER}=2.05\text{ V}$ to 5.5 V , $I_{OUT}=0.01$ to 7 A	1.225	1.250	1.275	
ΔV_O	Line regulation	$V_{CONTROL}=2.5\text{ V}$ to 12 V $V_{POWER}=1.75\text{ V}$ to 5.5 V , $I_{OUT}=10\text{ mA}$		0.08	0.24	%
ΔV_O	Load regulation	$V_{CONTROL}=2.75\text{ V}$, $V_{POWER}=2.1\text{ V}$ $I_{OUT}=0.01$ to 7 A		0.08	0.4	%
I_C	$V_{CONTROL}$ pin current	$V_{CONTROL}=2.75\text{ V}$, $V_{POWER}=2.05\text{ V}$ $I_{OUT}=100\text{ mA}$		6	10	mA
		$V_{CONTROL}=2.75\text{ V}$, $V_{POWER}=2.05\text{ V}$ $I_{OUT}=4\text{ A}$		30	60	
		$V_{CONTROL}=2.75\text{ V}$, $V_{POWER}=1.75\text{ V}$ $I_{OUT}=4\text{ A}$		33	70	
		$V_{CONTROL}=2.75\text{ V}$, $V_{POWER}=2.05\text{ V}$ $I_{OUT}=7\text{ A}$		60	120	
I_{ADJ}	Adjust pin current	$V_{CONTROL}=2.75\text{ V}$, $V_{POWER}=2.05\text{ V}$ $I_{OUT}=10\text{ mA}$		50	120	μA
I_{OUT}	Output current limit	$V_{CONTROL}=2.75\text{ V}$, $V_{POWER}=2.05\text{ V}$ ⁽¹⁾	8	9		A
SVR	Supply voltage rejection	$V_{CONTROL}=V_{POWER}=3.75\text{ V Avg}$ $V_{RIPPLE}=1\text{ V}_{P-P}$, $I_{OUT}=4\text{ A}$, $T_J=25\text{ °C}$	61.5	81.5		dB
V_{DC}	Minimum $V_{CONTROL}$ voltage, ($V_{CONTROL}-V_O$)	$V_{POWER}=2.05\text{ V}$, $I_{OUT}=100\text{ mA}$ ⁽²⁾		0.95	1.15	V
		$V_{POWER}=2.05\text{ V}$, $I_{OUT}=1\text{ A}$		0.95	1.15	
		$V_{POWER}=2.05\text{ V}$, $I_{OUT}=4\text{ A}$		1	1.2	
		$V_{POWER}=2.05\text{ V}$, $I_{OUT}=7\text{ A}$		1.05	1.3	
V_{DP}	Minimum V_{POWER} voltage ($V_{POWER}-V_O$)	$V_{CONTROL}=2.75\text{ V}$, $I_{OUT}=1\text{ A}$ ⁽²⁾		0.05	0.15	V
		$V_{CONTROL}=2.75\text{ V}$, $I_{OUT}=4\text{ A}$		0.2	0.4	
		$V_{CONTROL}=2.75\text{ V}$, $I_{OUT}=7\text{ A}$		0.4	0.6	
T_{SHDN}	Shutdown temperature threshold			170		$^{\circ}\text{C}$
T_{HYST}	Thermal shutdown hysteresis			5		$^{\circ}\text{C}$

1. Measured when the V_{OUT} voltage drops below 100 mV with respect to its nominal value.

2. Measured when the V_{OUT} voltage drops below 2 % with respect to its nominal value.

6 Typical characteristics

(unless otherwise specified $T_J = 25\text{ }^\circ\text{C}$, $C_P = 330\text{ }\mu\text{F}$, $C_C = 10\text{ }\mu\text{F}$, $C_{OUT} = 100\text{ }\mu\text{F}$)

Figure 4. Output voltage vs temperature

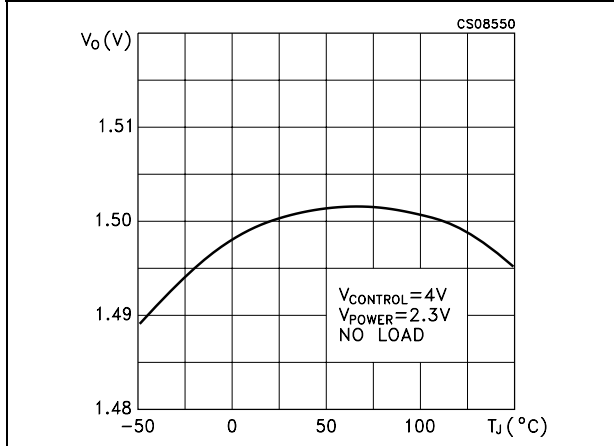

Figure 5. Minimum VCONTROL voltage vs temperature

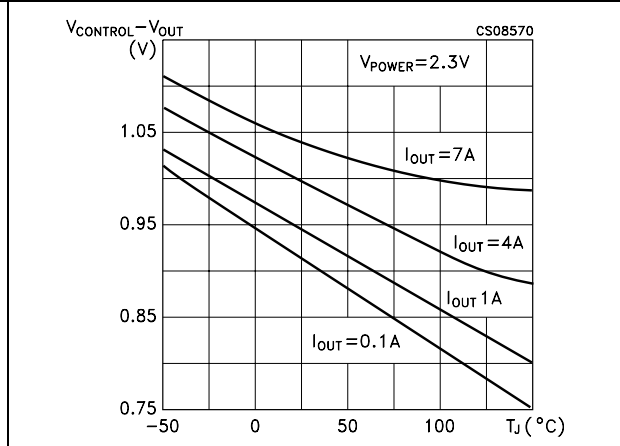

Figure 6. Minimum VPOWER voltage vs output current

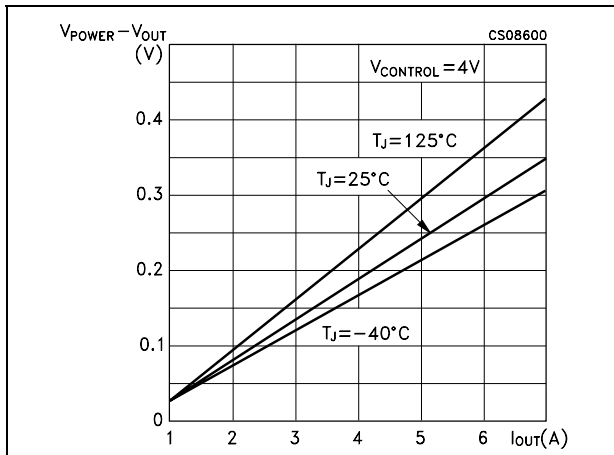

Figure 7. Output voltage vs temperature

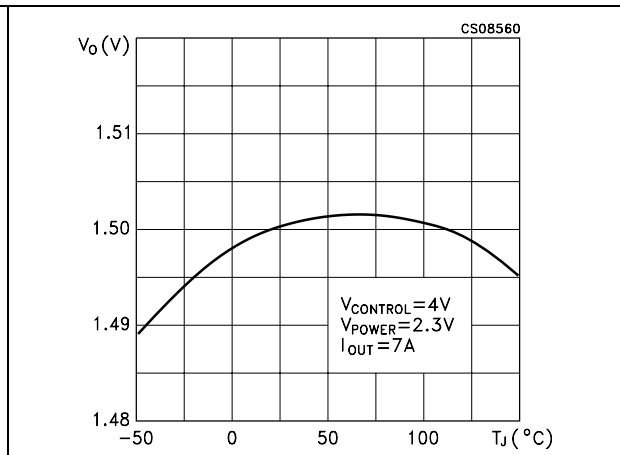

Figure 8. VCONTROL pin current vs temp.

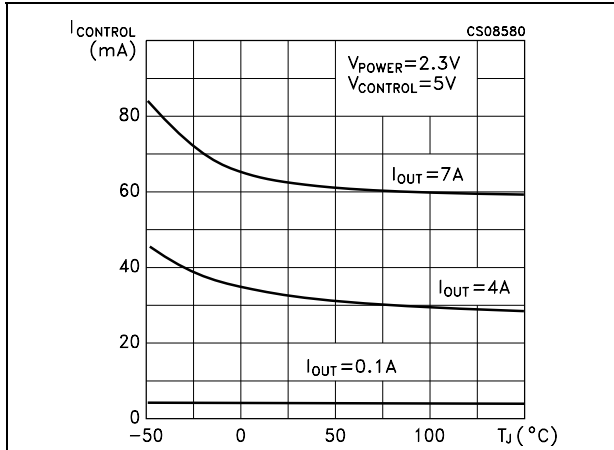

Figure 9. Minimum VPOWER voltage vs temp.

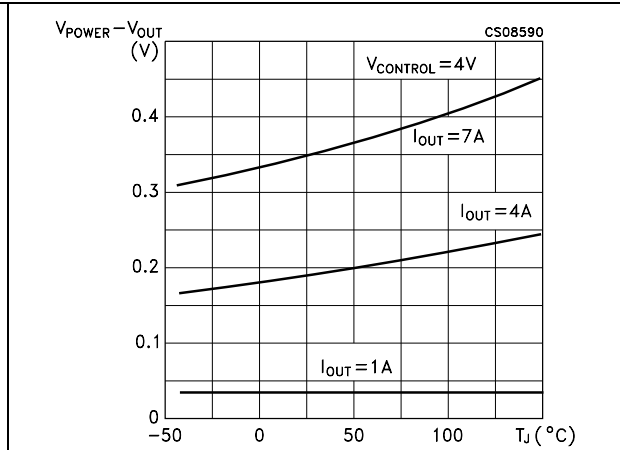

Figure 10. $V_{CONTROL}$ pin current vs output current

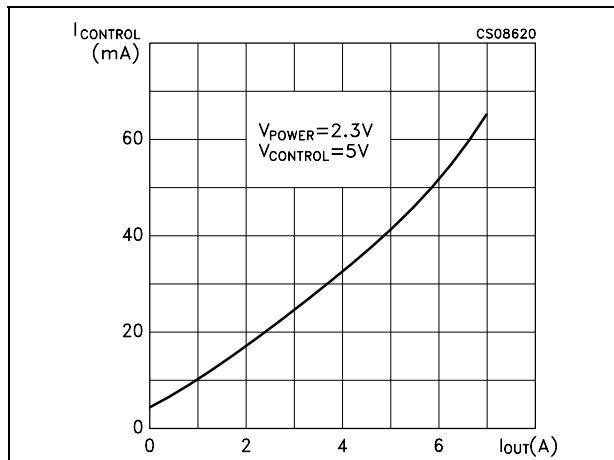

Figure 11. Output current limit vs temperature

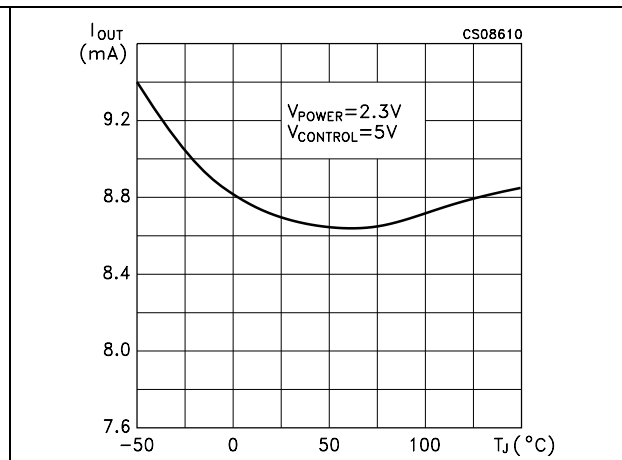

Figure 12. Quiescent current vs temperature

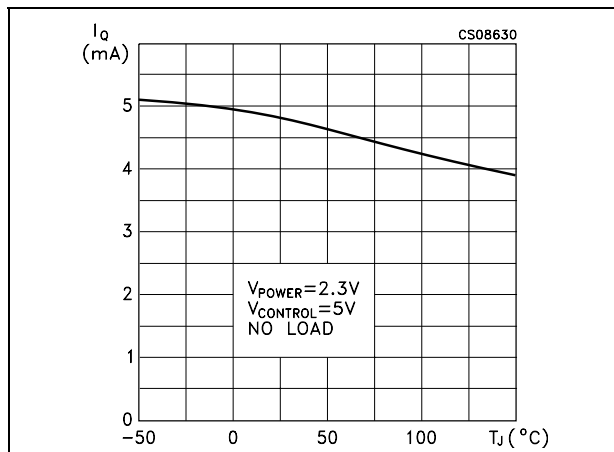

Figure 13. Supply voltage rejection vs output current

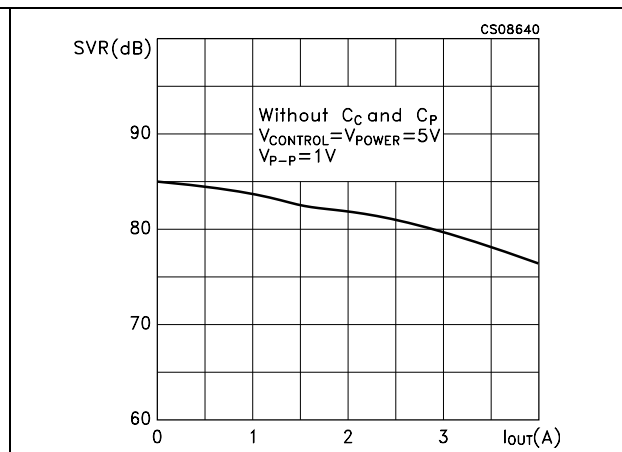

Figure 14. Line transient response

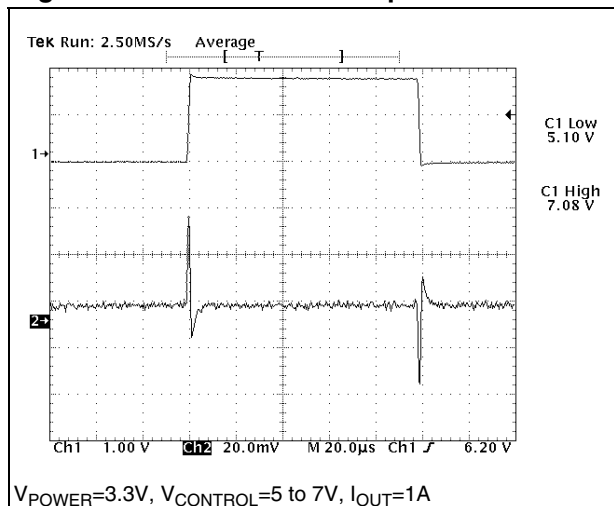

Figure 15. Line transient response

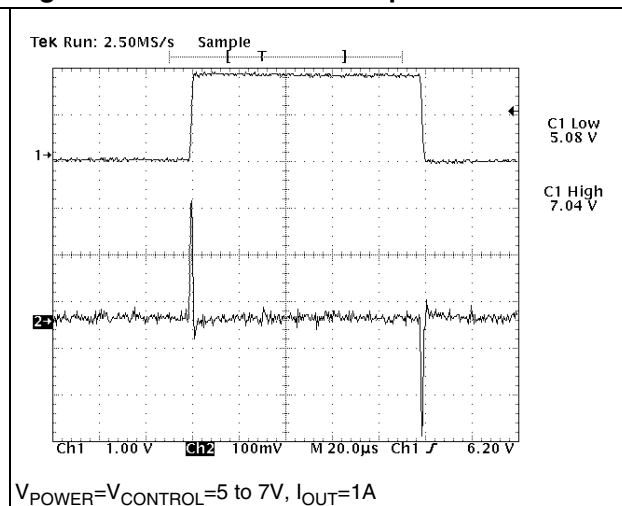

Figure 16. Load transient response

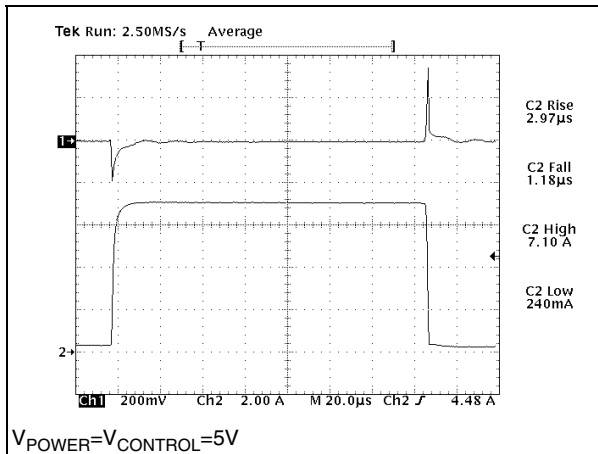

Figure 17. Load transient response

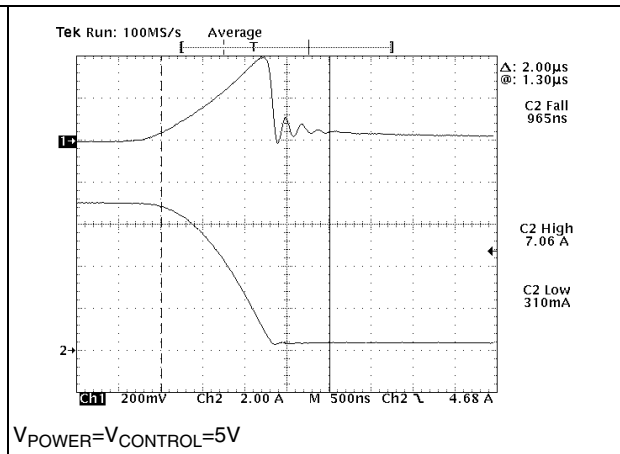
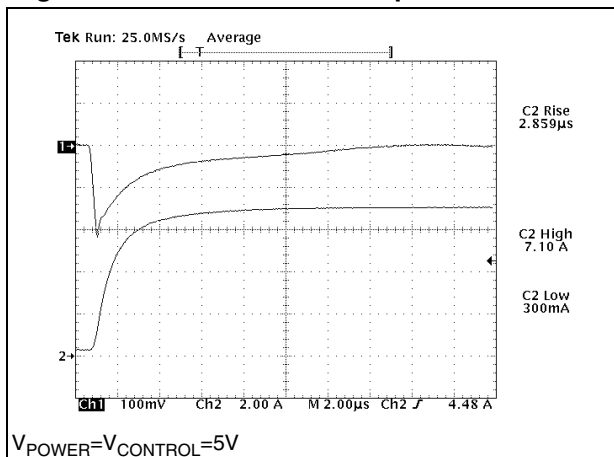

Figure 18. Load transient response



7 Package mechanical data

In order to meet environmental requirements, ST offers these devices in ECOPACK[®] packages. These packages have a lead-free second level interconnect. The category of second Level Interconnect is marked on the package and on the inner box label, in compliance with JEDEC Standard JESD97. The maximum ratings related to soldering conditions are also marked on the inner box label. ECOPACK is an ST trademark. ECOPACK specifications are available at: www.st.com.

P²PAK mechanical data

Dim.	mm.			inch.		
	Min.	Typ.	Max.	Min.	Typ.	Max.
A	4.30		4.80	0.169		0.188
A1	2.40		2.80	0.094		0.110
A2	0.03		0.23	0.001		0.009
b	0.80		1.05	0.031		0.041
c	0.45		0.60	0.017		0.023
c2	1.17		1.37	0.046		0.053
D	8.95		9.35	0.352		0.368
D2		8			0.315	
E	10.00		10.40	0.393		0.409
E1		8.5			0.334	0.409
e	3.20		3.60	0.126		0.142
e1	6.60		7.00	0.260		0.275
L	13.70		14.50	0.539		0.571
L2	1.25		1.40	0.049		0.055
L3	0.90		1.70	0.035		0.067
L5	1.55		2.40	0.061		0.094
R		0.40			0.016	
V2	0°		8°	0°		8°

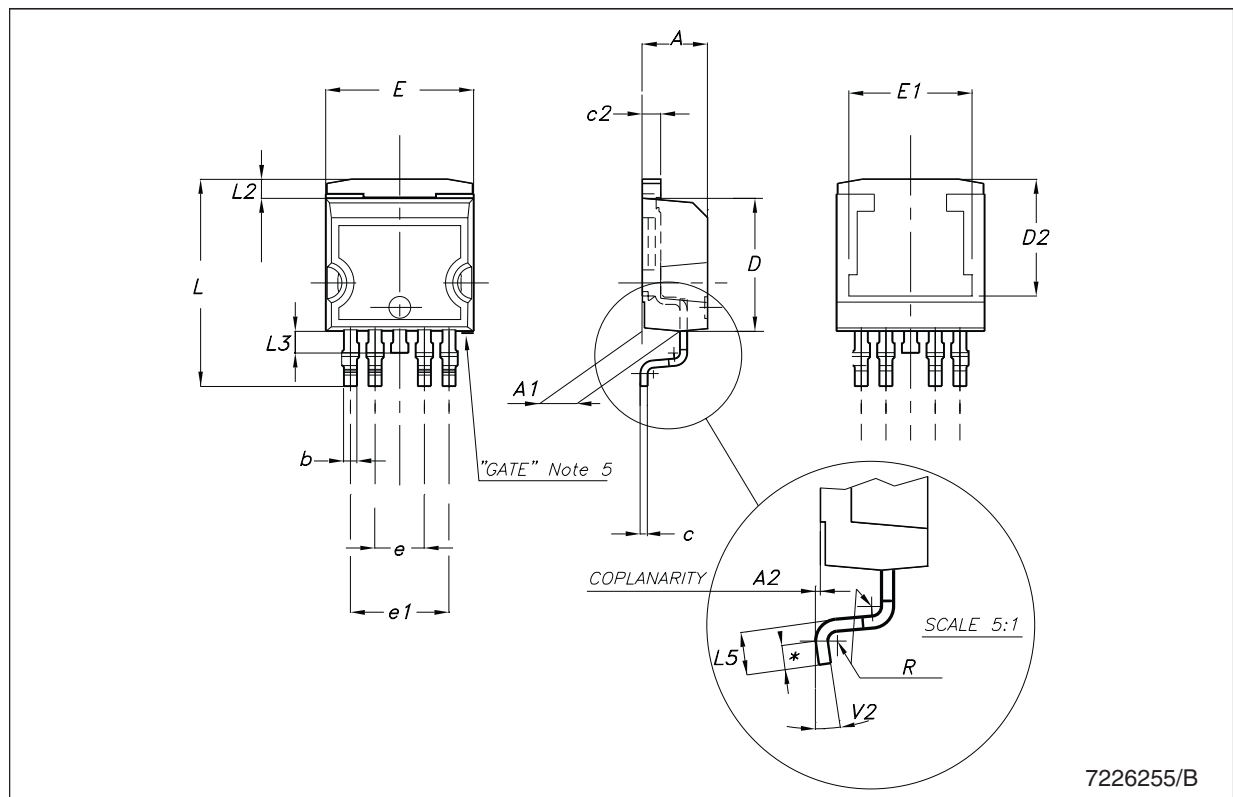

Tape & reel D²PAK-P²PAK-D²PAK/A-P²PAK/A mechanical data

Dim.	mm.			inch.		
	Min.	Typ.	Max.	Min.	Typ.	Max.
A			180			7.086
C	12.8	13.0	13.2	0.504	0.512	0.519
D	20.2			0.795		
N	60			2.362		
T			14.4			0.567
Ao	10.50	10.6	10.70	0.413	0.417	0.421
Bo	15.70	15.80	15.90	0.618	0.622	0.626
Ko	4.80	4.90	5.00	0.189	0.193	0.197
Po	3.9	4.0	4.1	0.153	0.157	0.161
P	11.9	12.0	12.1	0.468	0.472	0.476

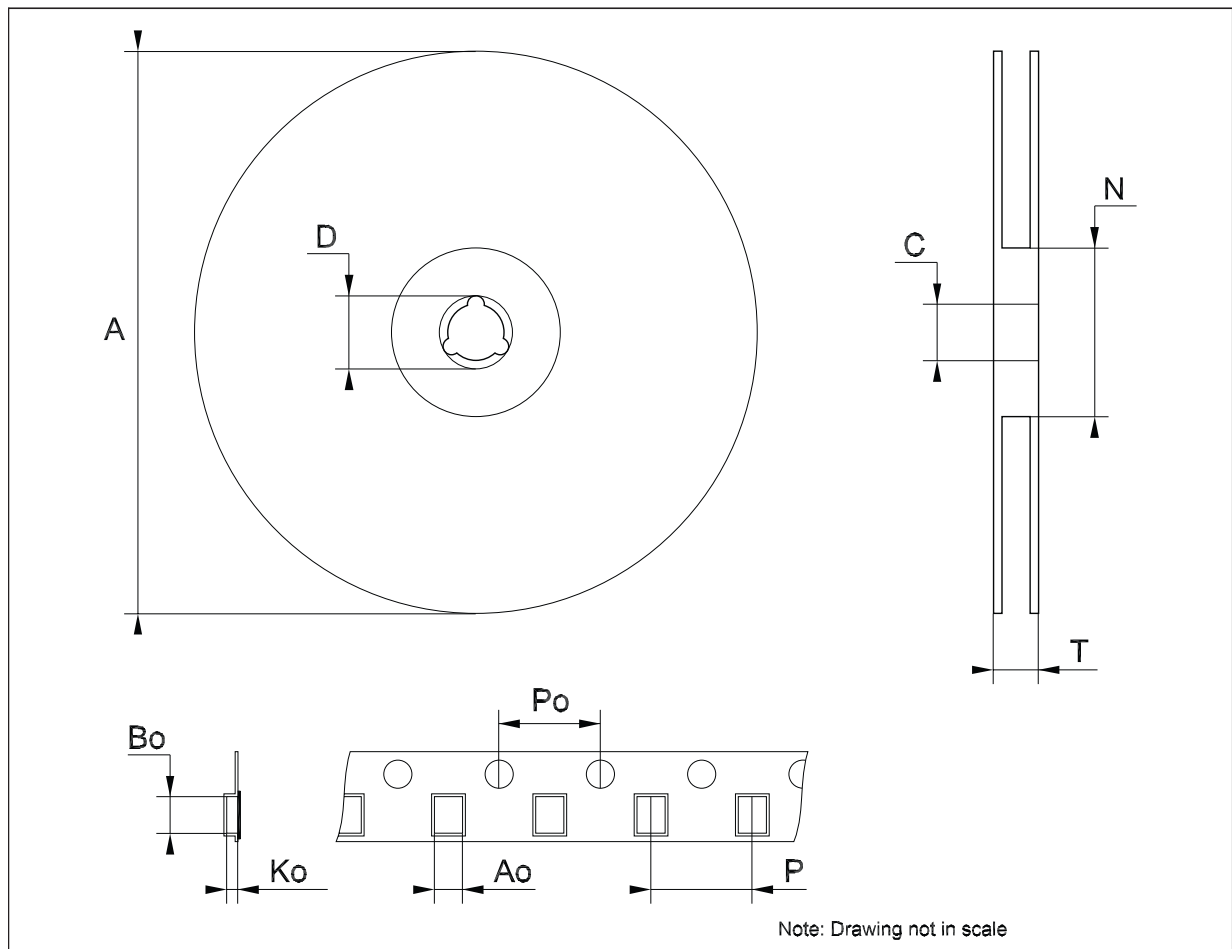

8 Revision history

Table 5. Document revision history

Date	Revision	Changes
08-Sep-2005	3	Order codes updated.
09-May-2007	4	Order codes updated.
16-Apr-2008	5	Modified: Table 1 on page 1 .

Please Read Carefully:

Information in this document is provided solely in connection with ST products. STMicroelectronics NV and its subsidiaries ("ST") reserve the right to make changes, corrections, modifications or improvements, to this document, and the products and services described herein at any time, without notice.

All ST products are sold pursuant to ST's terms and conditions of sale.

Purchasers are solely responsible for the choice, selection and use of the ST products and services described herein, and ST assumes no liability whatsoever relating to the choice, selection or use of the ST products and services described herein.

No license, express or implied, by estoppel or otherwise, to any intellectual property rights is granted under this document. If any part of this document refers to any third party products or services it shall not be deemed a license grant by ST for the use of such third party products or services, or any intellectual property contained therein or considered as a warranty covering the use in any manner whatsoever of such third party products or services or any intellectual property contained therein.

UNLESS OTHERWISE SET FORTH IN ST'S TERMS AND CONDITIONS OF SALE ST DISCLAIMS ANY EXPRESS OR IMPLIED WARRANTY WITH RESPECT TO THE USE AND/OR SALE OF ST PRODUCTS INCLUDING WITHOUT LIMITATION IMPLIED WARRANTIES OF MERCHANTABILITY, FITNESS FOR A PARTICULAR PURPOSE (AND THEIR EQUIVALENTS UNDER THE LAWS OF ANY JURISDICTION), OR INFRINGEMENT OF ANY PATENT, COPYRIGHT OR OTHER INTELLECTUAL PROPERTY RIGHT.

UNLESS EXPRESSLY APPROVED IN WRITING BY AN AUTHORIZED ST REPRESENTATIVE, ST PRODUCTS ARE NOT RECOMMENDED, AUTHORIZED OR WARRANTED FOR USE IN MILITARY, AIR CRAFT, SPACE, LIFE SAVING, OR LIFE SUSTAINING APPLICATIONS, NOR IN PRODUCTS OR SYSTEMS WHERE FAILURE OR MALFUNCTION MAY RESULT IN PERSONAL INJURY, DEATH, OR SEVERE PROPERTY OR ENVIRONMENTAL DAMAGE. ST PRODUCTS WHICH ARE NOT SPECIFIED AS "AUTOMOTIVE GRADE" MAY ONLY BE USED IN AUTOMOTIVE APPLICATIONS AT USER'S OWN RISK.

Resale of ST products with provisions different from the statements and/or technical features set forth in this document shall immediately void any warranty granted by ST for the ST product or service described herein and shall not create or extend in any manner whatsoever, any liability of ST.

ST and the ST logo are trademarks or registered trademarks of ST in various countries.

Information in this document supersedes and replaces all information previously supplied.

The ST logo is a registered trademark of STMicroelectronics. All other names are the property of their respective owners.

© 2008 STMicroelectronics - All rights reserved

STMicroelectronics group of companies

Australia - Belgium - Brazil - Canada - China - Czech Republic - Finland - France - Germany - Hong Kong - India - Israel - Italy - Japan - Malaysia - Malta - Morocco - Singapore - Spain - Sweden - Switzerland - United Kingdom - United States of America

www.st.com

