

300 mA low quiescent current soft-start, low noise voltage regulator

Datasheet – production data

Features

- Input voltage from 1.5 to 5.5 V
- Ultra low dropout voltage (200 mV typ. at 300 mA load)
- Very low quiescent current (20 μ A typ. at no load, 40 μ A typ. at 300 mA load, 1 μ A max. in off mode)
- Very low noise (33 μ V_{RMS} from 1 kHz to 100 kHz at V_{OUT} = 1.8 V)
- Output voltage tolerance: \pm 2.0 % @ 25 °C
- 300 mA guaranteed output current
- Wide range of output voltages available on request: 0.8 V to 4.5 V with 100 mV step
- Logic-controlled electronic shutdown
- Compatible with ceramic capacitor C_{OUT} = 1 μ F
- Internal current and thermal limit
- Flip-chip 4 bumps 0.8 x 0.8 mm pitch 0.4 mm
- Internal soft-start (typ. 100 μ s)
- Temperature range: - 40 °C to 125 °C

Applications

- Mobile phones
- Personal digital assistants (PDAs)
- Cordless phones and similar battery-powered systems
- Digital still cameras.

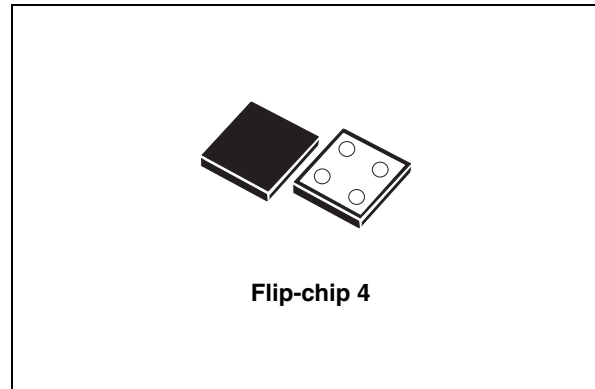

Description

The LD39030SJxx is a low noise voltage regulator that provides 300 mA maximum current from an input voltage in the 1.5 V to 5.5 V range, with a typical dropout voltage of 200 mV. It is stabilized with a ceramic capacitor on the output. The ultra low drop voltage, low quiescent current, and low noise features make it suitable for low power battery-powered applications. Power supply rejection is typically 62 dB at low frequencies and starts to roll off at 10 kHz. An enable logic control function puts the LD39030SJxx in shutdown mode allowing a total current consumption lower than 1 μ A. The device also includes a short-circuit constant current limiting and thermal protection.

Table 1. Device summary

Part numbers	Order codes	Output voltages
LD39030SJXX12	LD39030SJ12R	1.2 V
LD39030SJXX126	LD39030SJ126R	1.26 V
LD39030SJXX33	LD39030SJ33R	3.3 V

Contents

1	Block diagram	3
2	Pin configuration	4
3	Typical application	5
4	Maximum ratings	6
5	Electrical characteristics	7
6	Soft-start function	9
7	Typical performance characteristics	10
8	Package mechanical data	13
9	Revision history	17

1 Block diagram

Figure 1. Block diagram

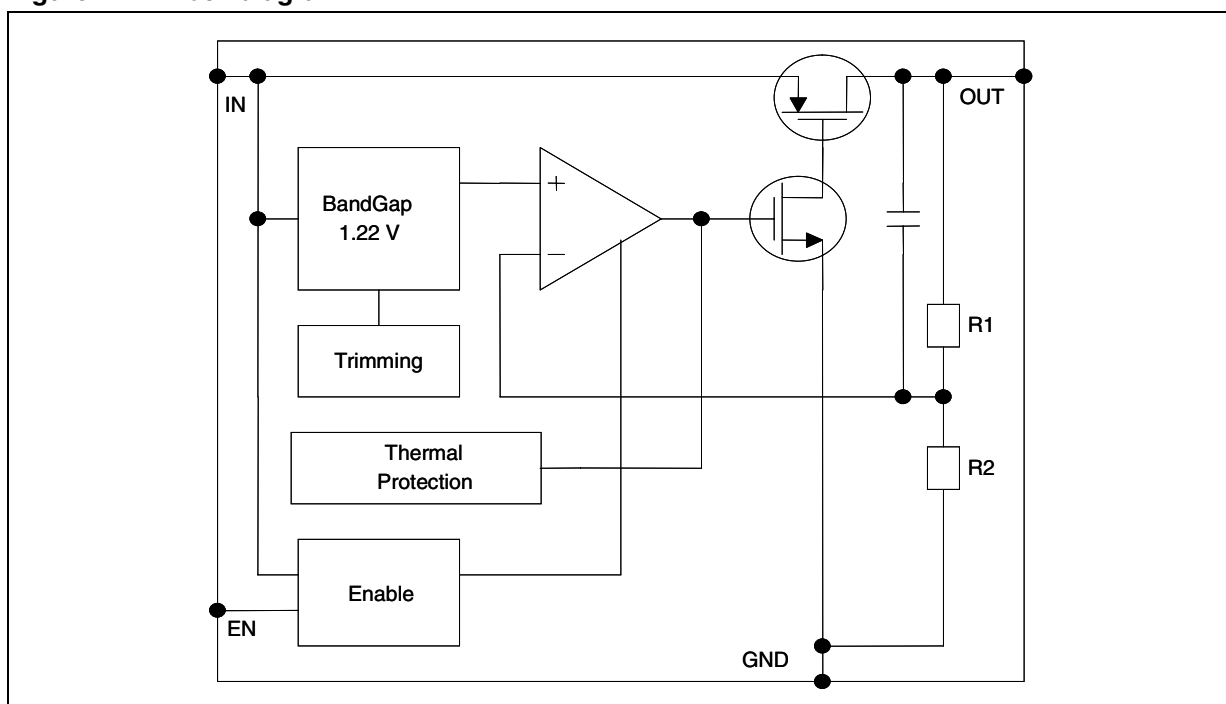

2 Pin configuration

Figure 2. Pin connection (top view)

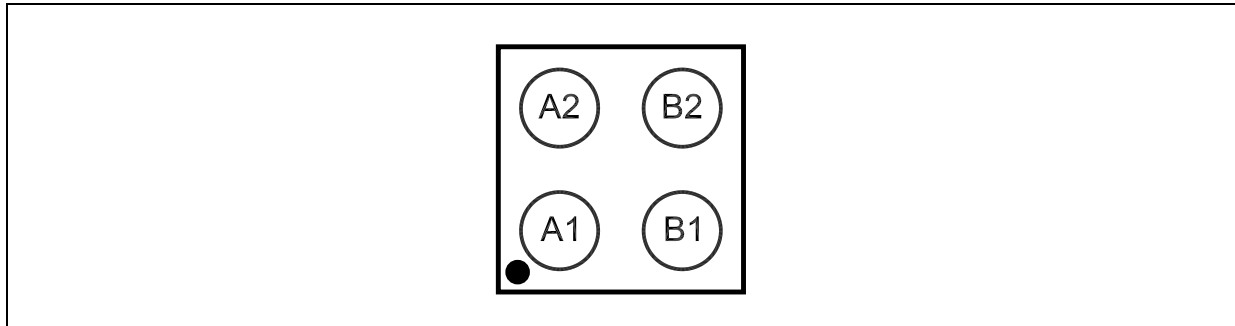
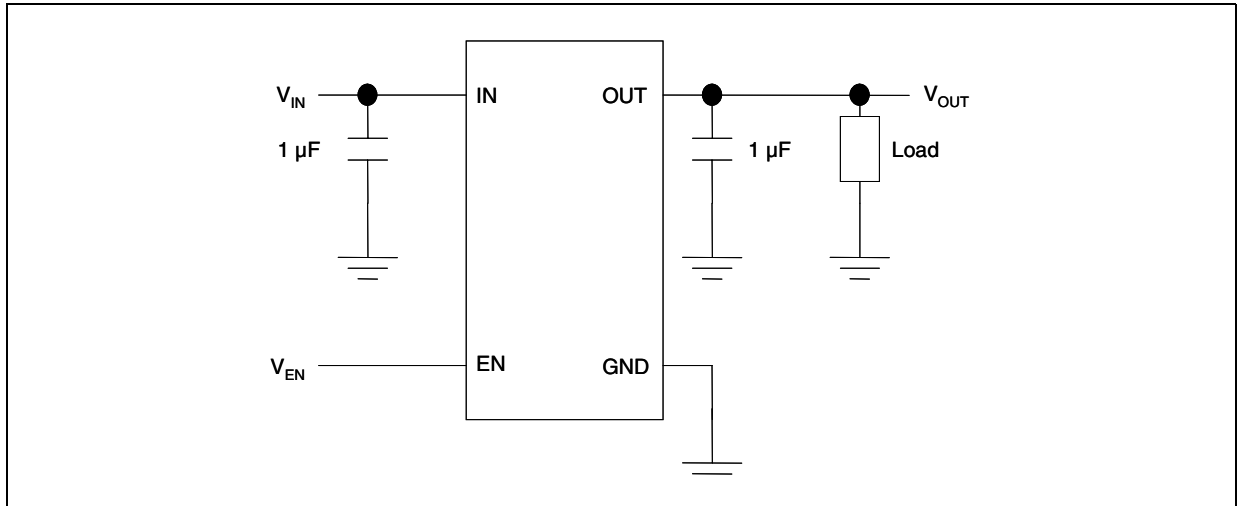

Table 2. Pin description

Pin n°	Symbol	Function
A2	EN	Enable pin logic input: low = shutdown, high = active
A1	GND	Common ground
B2	IN	Input voltage of the LDO
B1	OUT	Output voltage

3 Typical application

Figure 3. Typical application circuit



4 Maximum ratings

Table 3. Absolute maximum ratings

Symbol	Parameter	Value	Unit
V_{IN}	DC input voltage	- 0.3 to 6	V
V_{OUT}	DC output voltage	- 0.3 to $V_I + 0.3$	V
V_{EN}	Enable input voltage	- 0.3 to $V_I + 0.3$	V
I_{OUT}	Output current	Internally limited	mA
P_D	Power dissipation	Internally limited	mW
T_{STG}	Storage temperature range	- 65 to 150	°C
T_{OP}	Operating junction temperature range	- 40 to 125	°C

Note: Absolute maximum ratings are those values beyond which damage to the device may occur. Functional operation under these conditions is not implied. All values are referred to GND.

Table 4. Thermal data

Symbol	Parameter	Value	Unit
R_{thJA}	Thermal resistance junction-ambient	180	°C/W

5 Electrical characteristics

$T_J = 25\text{ °C}$, $V_{IN} = V_{OUT(NOM)} + 1\text{ V}$, $C_{IN} = C_{OUT} = 1\text{ }\mu\text{F}$, $I_{OUT} = 1\text{ mA}$, $V_{EN} = V_{IN}$, unless otherwise specified.

Table 5. Electrical characteristics for LD39030SJxx (1)

Symbol	Parameter	Test conditions	Min.	Typ.	Max.	Unit
V_{IN}	Operating input voltage		1.5		5.5	V
V_{UVLO}	Turn-on threshold			1.45	1.48	V
	Turn-off threshold		1.30	1.35		mV
V_{OUT}	V_{OUT} accuracy	$V_{OUT} > 1.5\text{ V}$, $I_{OUT} = 1\text{ mA}$, $T_J = 25\text{ °C}$	-2.0		2.0	%
		$V_{OUT} > 1.5\text{ V}$, $I_{OUT} = 1\text{ mA}$, $-40\text{ °C} < T_J < 125\text{ °C}$	-3.0		3.0	%
		$V_{OUT} \leq 1.5\text{ V}$, $I_{OUT} = 1\text{ mA}$		± 10		mV
		$V_{OUT} \leq 1.5\text{ V}$, $I_{OUT} = 1\text{ mA}$, $-40\text{ °C} < T_J < 125\text{ °C}$		± 30		mV
ΔV_{OUT}	Static line regulation	$V_{OUT} + 1\text{ V} \leq V_{IN} \leq 5.5\text{ V}$, $I_{OUT} = 1\text{ mA}$		0.01		%/V
ΔV_{OUT}	Transient line regulation (2)	$\Delta V_{IN} = +500\text{ mV}$, $I_{OUT} = 1\text{ mA}$, $T_R = T_F = 5\text{ }\mu\text{s}$		10		mVpp
ΔV_{OUT}	Static load regulation	$I_{OUT} = 1\text{ mA}$ to 300 mA		0.002		%/mA
ΔV_{OUT}	Transient load regulation (2)	$I_{OUT} = 1\text{ mA}$ to 300 mA , $T_R = T_F = 5\text{ }\mu\text{s}$		40		mVpp
V_{DROP}	Dropout voltage (3)	$I_{OUT} = 300\text{ mA}$, $V_{OUT} > 1.5\text{ V}$, $-40\text{ °C} < T_J < 125\text{ °C}$		200		mV
e_N	Output noise voltage	10 Hz to 100 kHz, $I_{OUT} = 10\text{ mA}$		30		$\mu\text{V}_{RMS}/\text{V}$
SVR	Supply voltage rejection $V_{OUT} = 1.2\text{ V}$	$V_{IN} = V_{OUT(NOM)} + 1\text{ V} \pm V_{RIPPLE}$ $V_{RIPPLE} = 0.1\text{ V}$ Freq. = 1 kHz $I_{OUT} = 10\text{ mA}$		62		dB
		$V_{IN} = V_{OUT(NOM)} + 0.5\text{ V} \pm V_{RIPPLE}$ $V_{RIPPLE} = 0.1\text{ V}$ Freq. = 10 kHz $I_{OUT} = 10\text{ mA}$		62		
I_Q	Quiescent current	$I_{OUT} = 0\text{ mA}$		20		μA
		$I_{OUT} = 0\text{ mA}$, $-40\text{ °C} < T_J < 125\text{ °C}$			50	
		$I_{OUT} = 0$ to 300 mA		40		
		$I_{OUT} = 0$ to 300 mA , $-40\text{ °C} < T_J < 125\text{ °C}$			85	
		V_{IN} input current in OFF MODE: $V_{EN} = \text{GND}$		0.001	1	
I_{SC}	Short-circuit current	$R_L = 0$	400			mA
V_{EN}	Enable input logic low	$V_{IN} = 1.5\text{ V}$ to 5.5 V , $-40\text{ °C} < T_J < 125\text{ °C}$			0.4	V
	Enable input logic high	$V_{IN} = 1.5\text{ V}$ to 5.5 V , $-40\text{ °C} < T_J < 125\text{ °C}$	0.9			

Table 5. Electrical characteristics for LD39030SJxx (continued)⁽¹⁾

Symbol	Parameter	Test conditions	Min.	Typ.	Max.	Unit
I_{EN}	Enable pin input current	$V_{SHDN}=V_{IN}$		0.1	100	nA
T_{ON}	Turn-on time ⁽⁴⁾			100		μ s
T_{SHDN}	Thermal shutdown			160		°C
	Hysteresis			20		
C_{OUT}	Output capacitor	Capacitance (see Section 7: Typical performance characteristics)	1		22	μ F

1. For $V_{OUT(NOM)} < 1.2$ V, $V_{IN} = 1.5$ V.
2. All transient values are guaranteed by design, not production tested.
3. Dropout voltage is the input-to-output voltage difference at which the output voltage is 100 mV below its nominal value. This specification does not apply for output voltages below 1.5 V.
4. Turn-on time is time measured between the enable input just exceeding V_{EN} high value and the output voltage just reaching 95 % of its nominal value.

6 Soft-start function

The LD39030SJxx has an internal soft-start circuit. By increasing the startup time up to 100 μs , without the need of any external soft-start capacitor, this feature is able to reduce the regulator inrush current to 1/3 of the original value.

Figure 4. Soft-start function

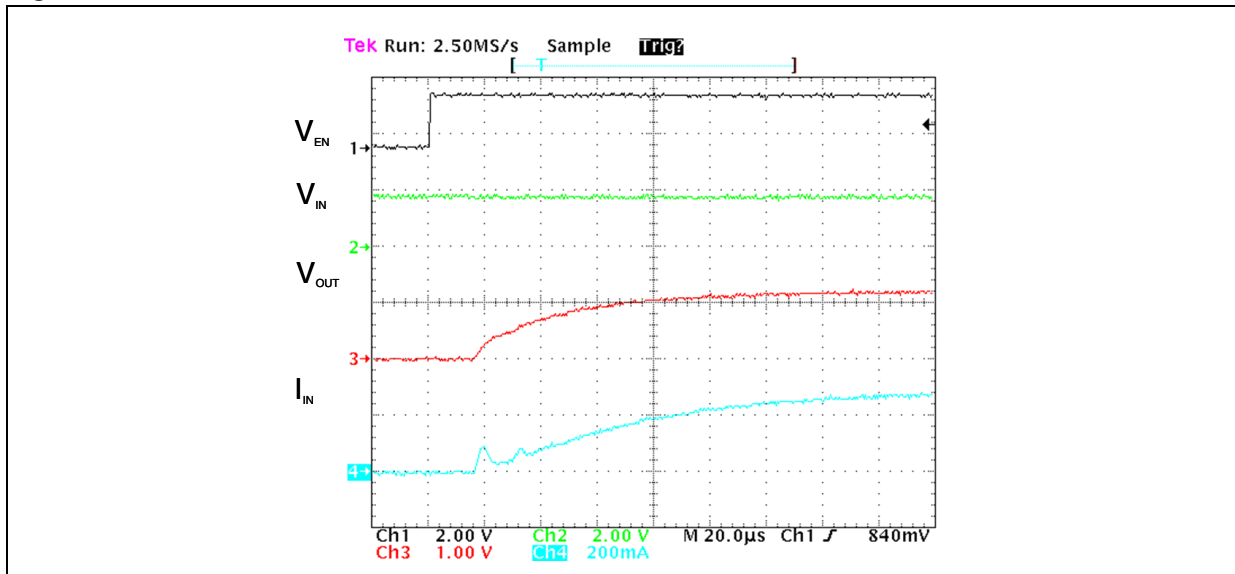

$V_{\text{IN}} = 1.8 \text{ V}$, $V_{\text{EN}} = 1.8 \text{ V}$, $C_{\text{IN}} = 1 \mu\text{F}$, $C_{\text{OUT}} = 1 \mu\text{F}$.

7 Typical performance characteristics

$C_{IN} = C_{OUT} = 1 \mu F, V_{EN}$ to V_{IN} .

Figure 5. Output voltage vs. temperature

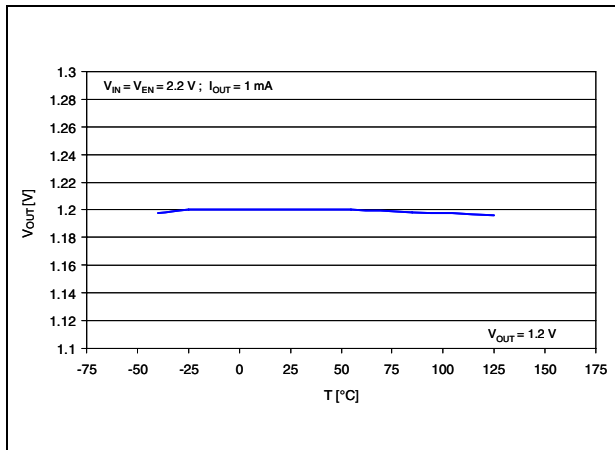

Figure 6. Output voltage vs. input voltage

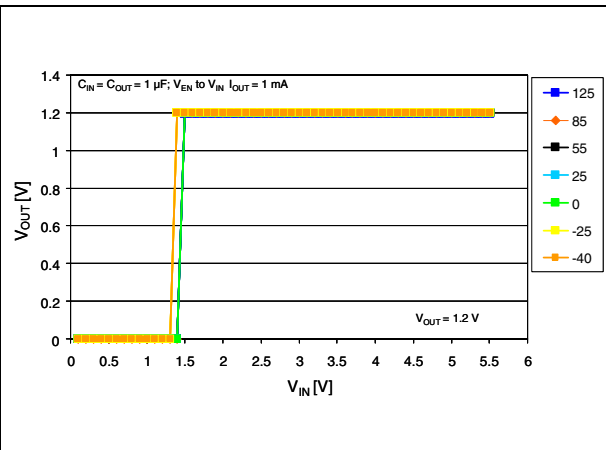

Figure 7. Line regulation vs. temperature

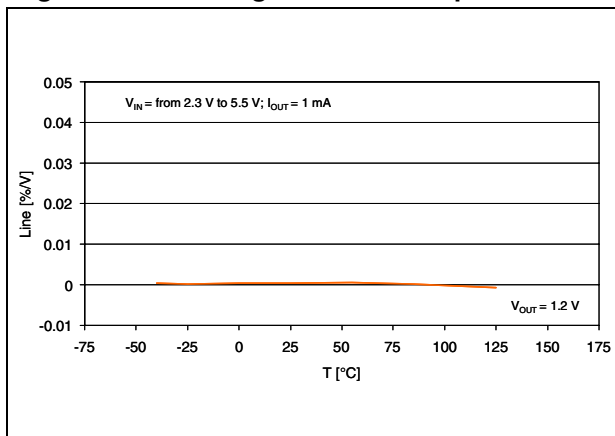

Figure 8. Load regulation vs. temperature

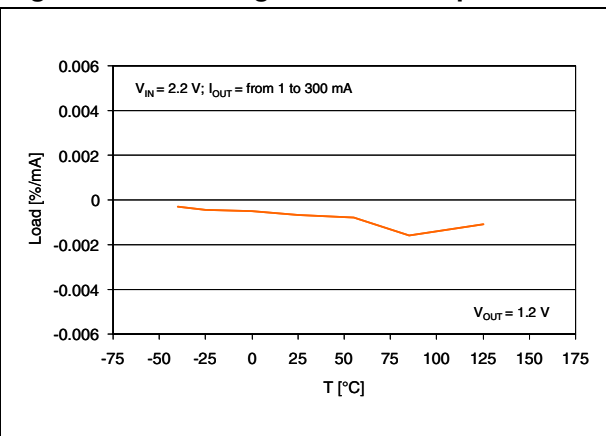

Figure 9. Short-circuit current vs. drop voltage

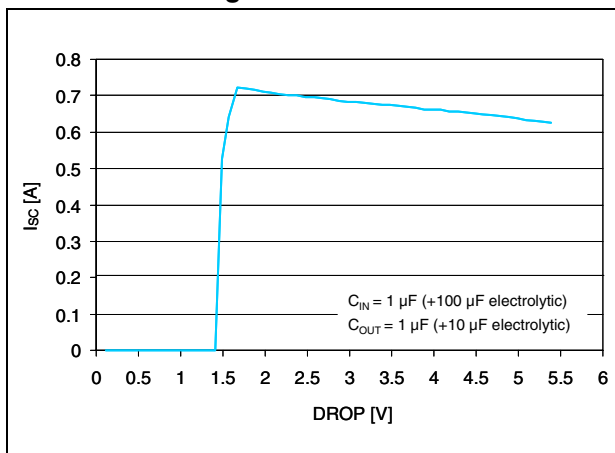

Figure 10. Quiescent current vs. input voltage

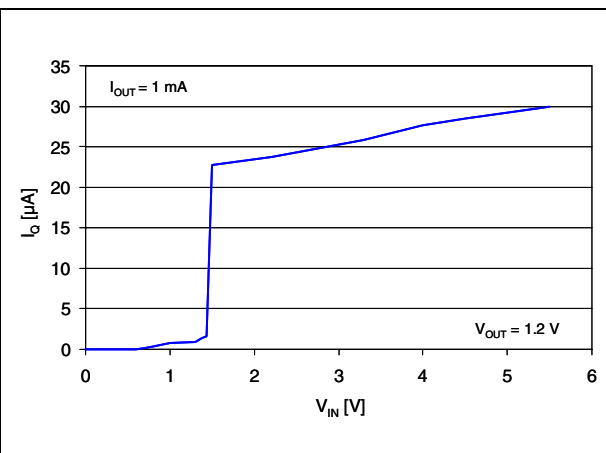

Figure 11. Enable threshold vs. temperature

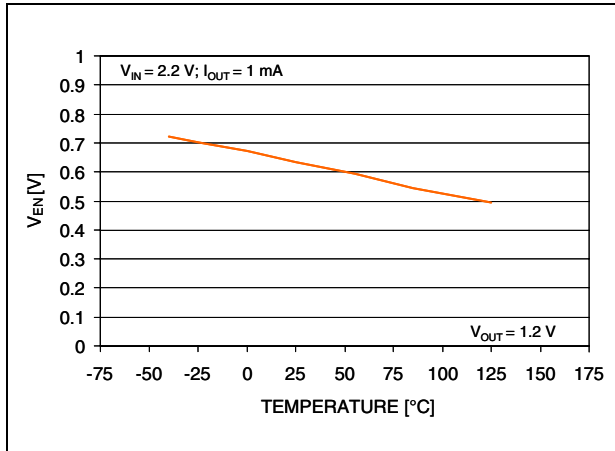

Figure 12. Quiescent current vs. temperature

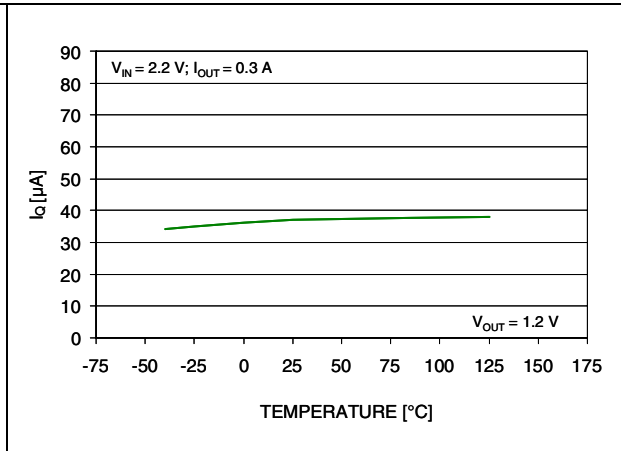

Figure 13. Supply voltage rejection vs. temperature (Freq. = 1 kHz)

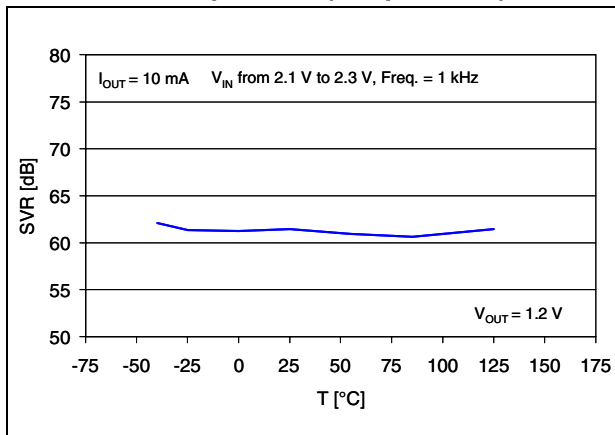

Figure 14. Supply voltage rejection vs. frequency (V_{IN} = 1.6 V to 1.8 V)

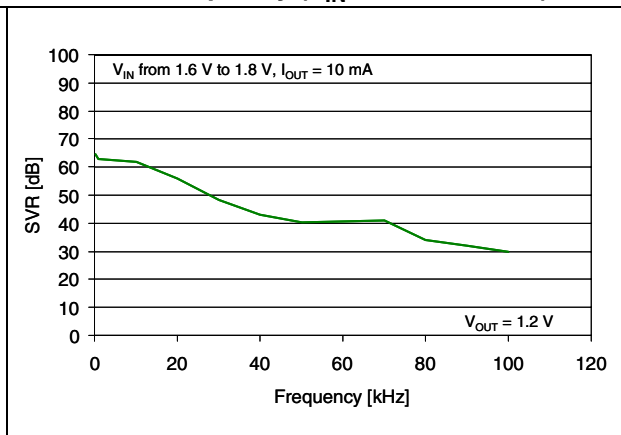

Figure 15. Supply voltage rejection vs. temperature (Freq. = 10 kHz)

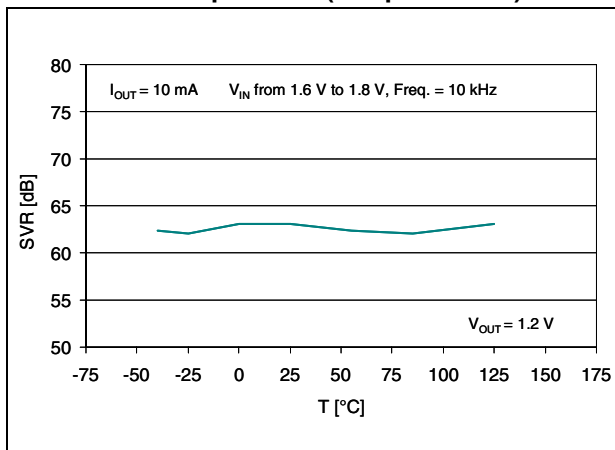

Figure 16. Supply voltage rejection vs. frequency (V_{IN} = 2.1 V to 2.3 V)

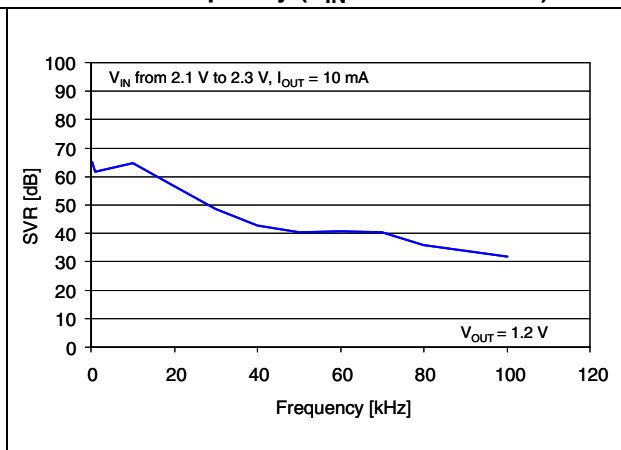

Figure 17. Line transient

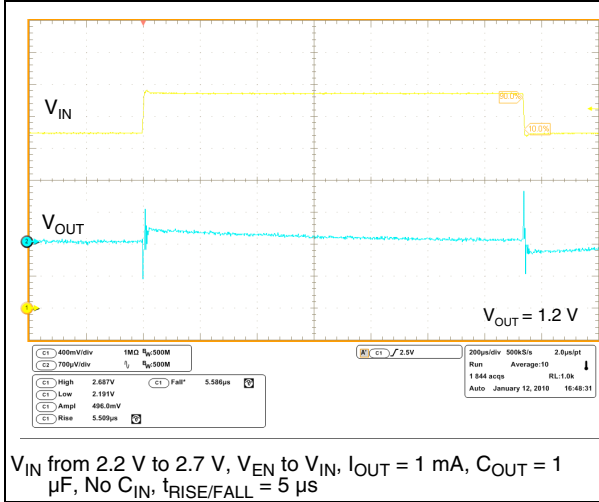

Figure 18. Load transient

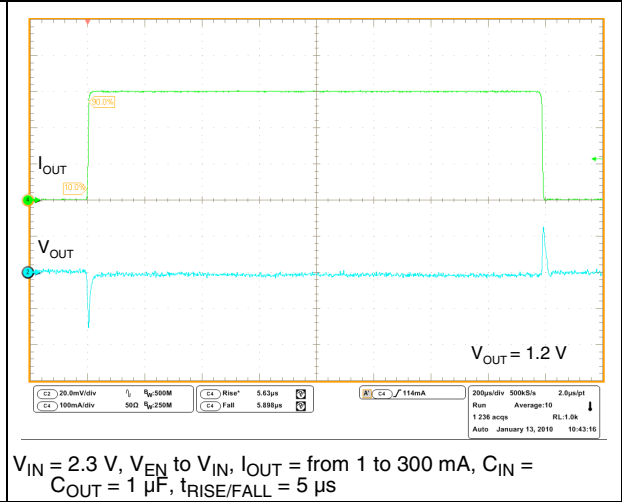

Figure 19. Enable transient

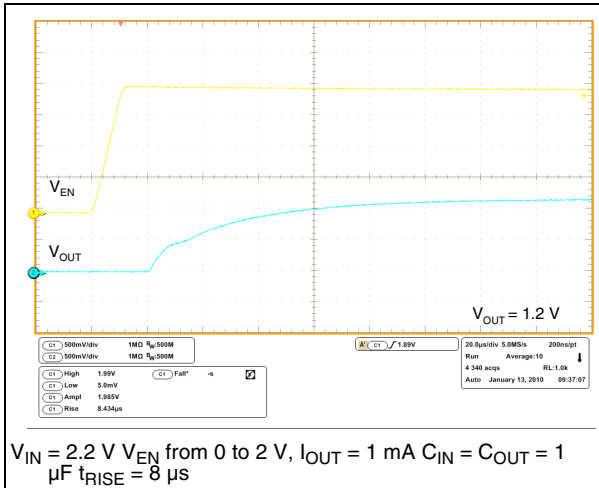

Figure 20. Startup transient

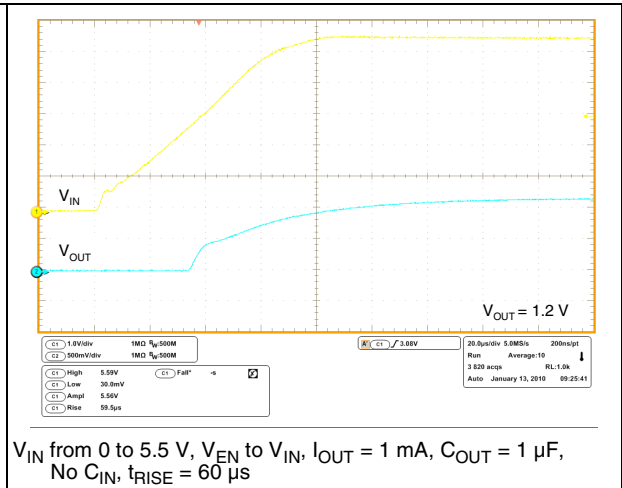
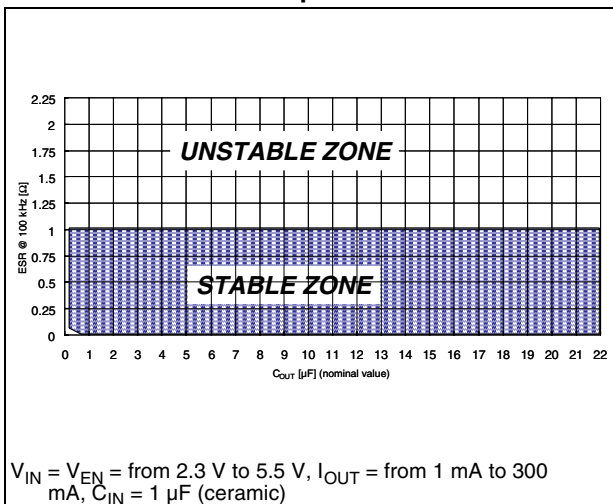

Figure 21. ESR required for stability with ceramic capacitors



8 Package mechanical data

In order to meet environmental requirements, ST offers these devices in different grades of ECOPACK® packages, depending on their level of environmental compliance. ECOPACK specifications, grade definitions, and product status are available at: www.st.com. ECOPACK is an ST registered trademark.

Table 6. Flip-chip 4 package mechanical data

Dim.	mm.		
	Min.	Typ.	Max.
A	0.52	0.56	0.60
A1	0.17	0.20	0.23
A2	0.35	0.36	0.37
b	0.23	0.25	0.29
D	0.758	0.788	0.818
D1		0.4	
E	0.758	0.788	0.818
E1		0.4	
SD	0.18	0.2	0.22
SE	0.18	0.2	0.22
f		0.199	
ccc		0.075	

Figure 22. Flip-chip 4 package drawing (dimensions are in mm.)

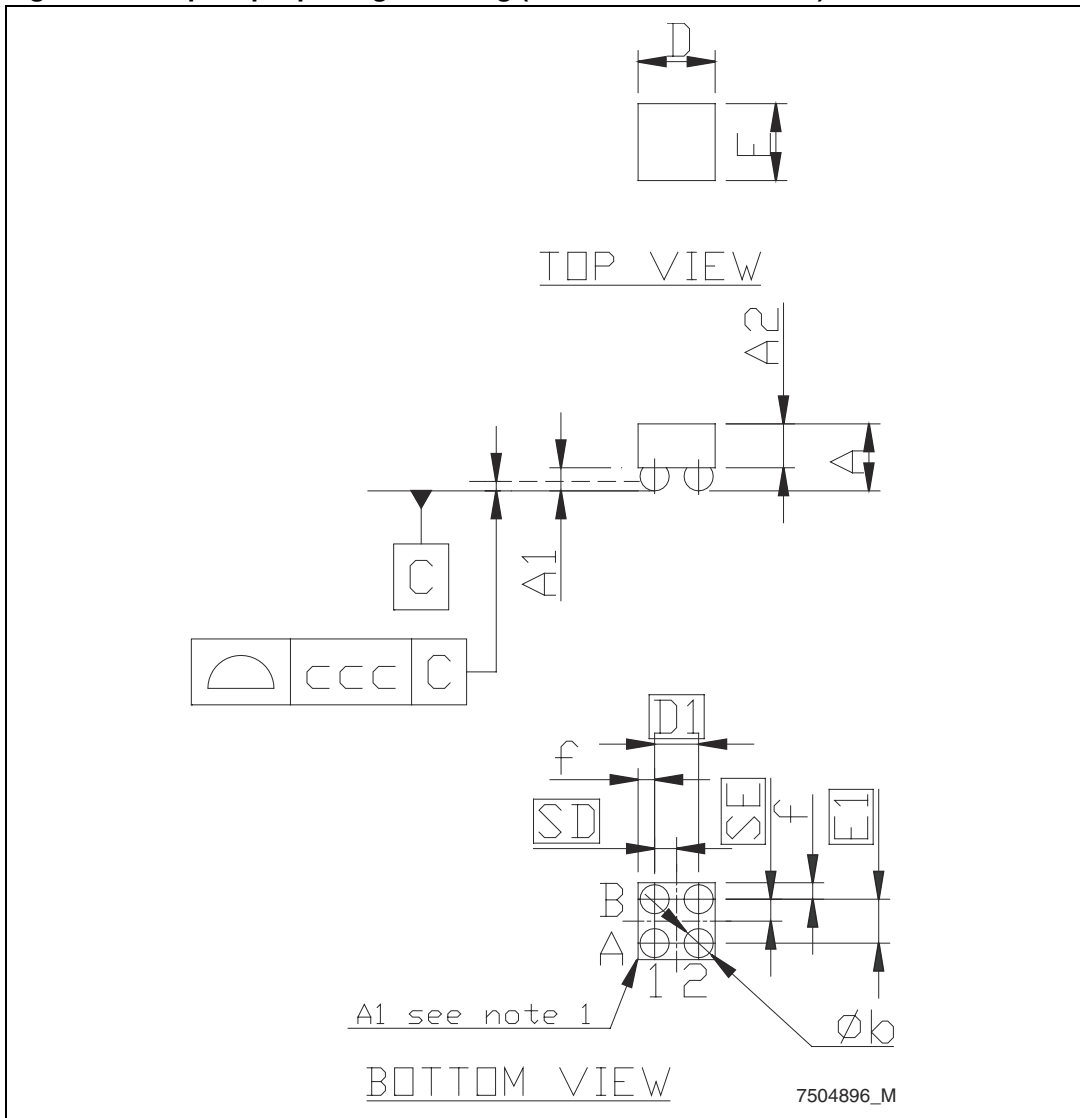

Tape and reel Flip-chip 4 mechanical data

Dim.	mm.			inch.		
	Min.	Typ.	Max.	Min.	Typ.	Max.
A			178			6.926
C	12.8		13.2	0.504		0.519
D	20.2			0.795		
N	59	60	61	2.323	2.362	2.401
T			8.4			0.331
Ao	0.82	0.87	0.92	0.032	0.034	0.036
Bo	0.82	0.87	0.92	0.032	0.034	0.036
Ko	0.64	0.69	0.74	0.025	0.027	0.029
Po	3.9	4	4.1	0.153	0.157	0.161
P	3.9	4	4.1	0.153	0.157	0.161

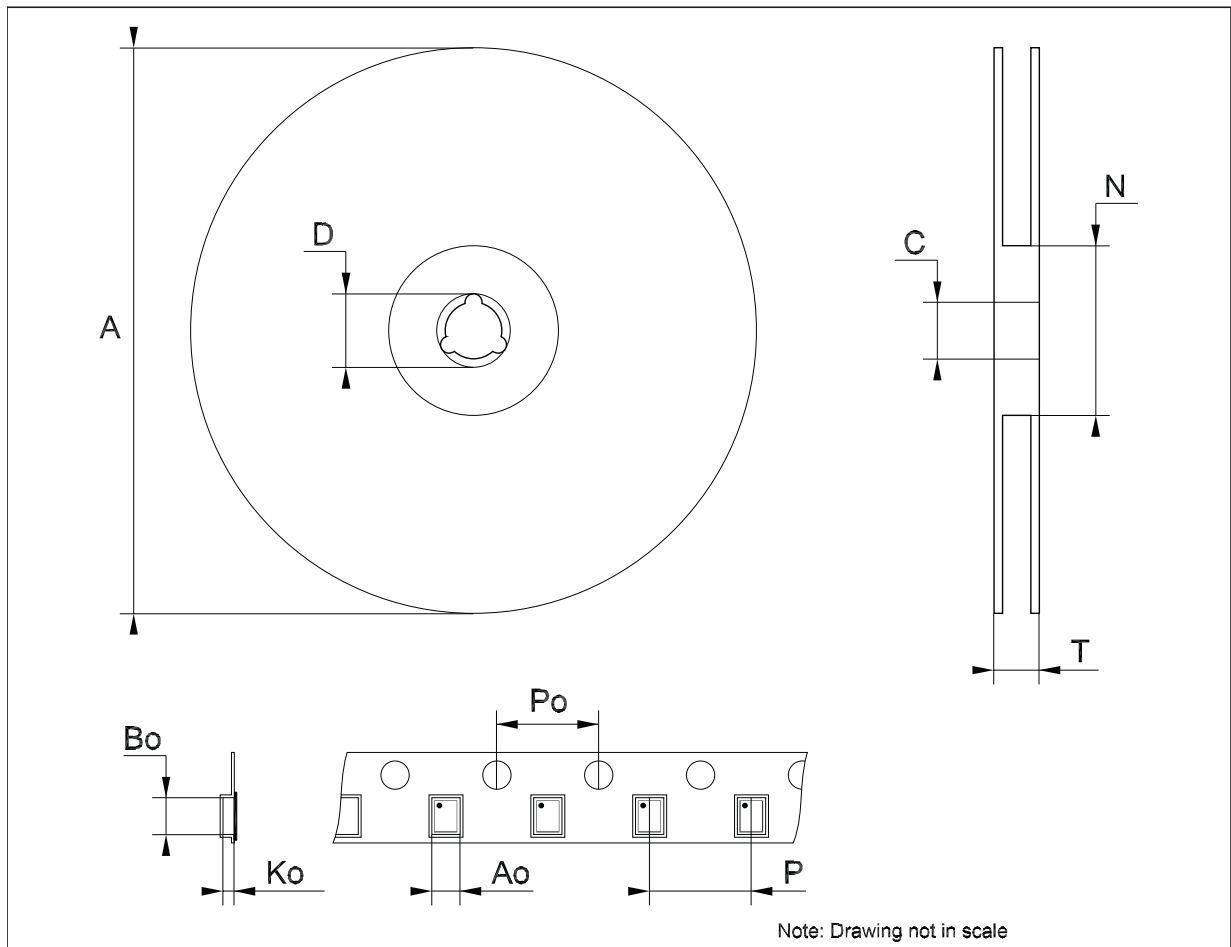
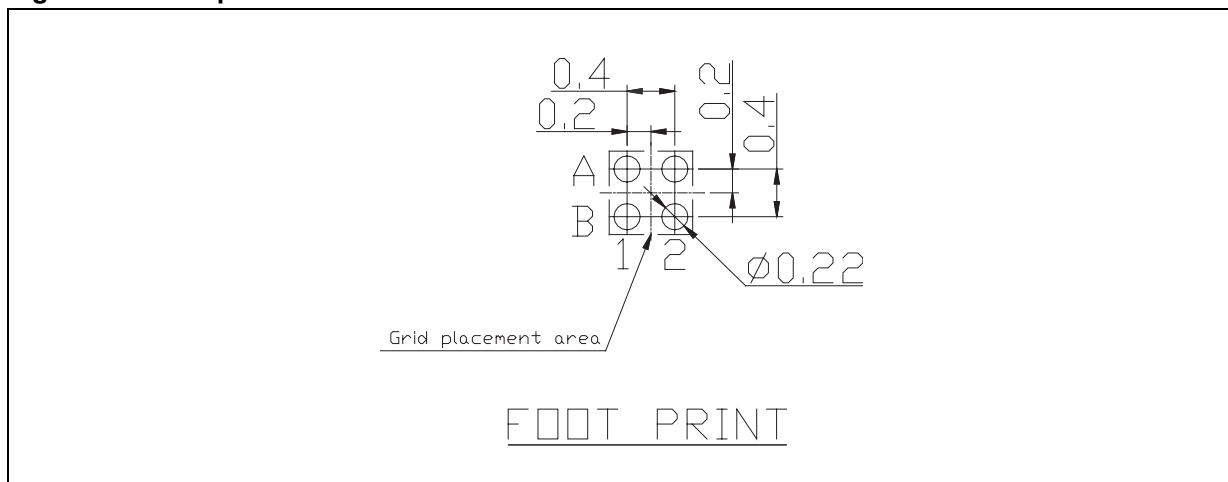

Figure 23. Footprint data



9 Revision history

Table 7. Document revision history

Date	Revision	Changes
14-Oct-2010	1	First release.
10-Jul-2012	2	Added: new order code LD39030SJ33R Table 1 on page 1 . Updated: Flip-chip 4 mechanical data Table 6 on page 13 and Figure 22 on page 14 .
25-Oct-2012	3	Added: new order code LD39030SJ126R Table 1 on page 1 . Document status promoted from preliminary data to production data.

Please Read Carefully:

Information in this document is provided solely in connection with ST products. STMicroelectronics NV and its subsidiaries ("ST") reserve the right to make changes, corrections, modifications or improvements, to this document, and the products and services described herein at any time, without notice.

All ST products are sold pursuant to ST's terms and conditions of sale.

Purchasers are solely responsible for the choice, selection and use of the ST products and services described herein, and ST assumes no liability whatsoever relating to the choice, selection or use of the ST products and services described herein.

No license, express or implied, by estoppel or otherwise, to any intellectual property rights is granted under this document. If any part of this document refers to any third party products or services it shall not be deemed a license grant by ST for the use of such third party products or services, or any intellectual property contained therein or considered as a warranty covering the use in any manner whatsoever of such third party products or services or any intellectual property contained therein.

UNLESS OTHERWISE SET FORTH IN ST'S TERMS AND CONDITIONS OF SALE ST DISCLAIMS ANY EXPRESS OR IMPLIED WARRANTY WITH RESPECT TO THE USE AND/OR SALE OF ST PRODUCTS INCLUDING WITHOUT LIMITATION IMPLIED WARRANTIES OF MERCHANTABILITY, FITNESS FOR A PARTICULAR PURPOSE (AND THEIR EQUIVALENTS UNDER THE LAWS OF ANY JURISDICTION), OR INFRINGEMENT OF ANY PATENT, COPYRIGHT OR OTHER INTELLECTUAL PROPERTY RIGHT.

UNLESS EXPRESSLY APPROVED IN WRITING BY TWO AUTHORIZED ST REPRESENTATIVES, ST PRODUCTS ARE NOT RECOMMENDED, AUTHORIZED OR WARRANTED FOR USE IN MILITARY, AIR CRAFT, SPACE, LIFE SAVING, OR LIFE SUSTAINING APPLICATIONS, NOR IN PRODUCTS OR SYSTEMS WHERE FAILURE OR MALFUNCTION MAY RESULT IN PERSONAL INJURY, DEATH, OR SEVERE PROPERTY OR ENVIRONMENTAL DAMAGE. ST PRODUCTS WHICH ARE NOT SPECIFIED AS "AUTOMOTIVE GRADE" MAY ONLY BE USED IN AUTOMOTIVE APPLICATIONS AT USER'S OWN RISK.

Resale of ST products with provisions different from the statements and/or technical features set forth in this document shall immediately void any warranty granted by ST for the ST product or service described herein and shall not create or extend in any manner whatsoever, any liability of ST.

ST and the ST logo are trademarks or registered trademarks of ST in various countries.

Information in this document supersedes and replaces all information previously supplied.

The ST logo is a registered trademark of STMicroelectronics. All other names are the property of their respective owners.

© 2012 STMicroelectronics - All rights reserved

STMicroelectronics group of companies

Australia - Belgium - Brazil - Canada - China - Czech Republic - Finland - France - Germany - Hong Kong - India - Israel - Italy - Japan - Malaysia - Malta - Morocco - Philippines - Singapore - Spain - Sweden - Switzerland - United Kingdom - United States of America

www.st.com