

LM4674

LM4674 Filterless 2.5W Stereo Class D Audio Power Amplifier



Literature Number: SNAS344D

www.BDTIC.com/TI

LM4674 Boomer® Audio Power Amplifier Series

Filterless 2.5W Stereo Class D Audio Power Amplifier

General Description

The LM4674 is a single supply, high efficiency, 2.5W/channel, filterless switching audio amplifier. A low noise PWM architecture eliminates the output filter, reducing external component count, board area consumption, system cost, and simplifying design.

The LM4674 is designed to meet the demands of mobile phones and other portable communication devices. Operating from a single 5V supply, the device is capable of delivering 2.5W/channel of continuous output power to a 4Ω load with less than 10% THD+N. Flexible power supply requirements allow operation from 2.4V to 5.5V.

The LM4674 features high efficiency compared to conventional Class AB amplifiers. When driving an 8Ω speaker from a 3.6V supply, the device features 85% efficiency at $P_O = 500\text{mW}$. Four gain options are pin selectable through the G0 and G1 pins.

Output short circuit protection prevents the device from being damaged during fault conditions. Superior click and pop suppression eliminates audible transients on power-up/down and during shutdown. Independent left/right shutdown control maximizes power savings in mixed mono/stereo applications.

Key Specifications

■ Efficiency at 3.6V, 100mW into 8Ω	80% (typ)
■ Efficiency at 3.6V, 500mW into 8Ω	85% (typ)
■ Efficiency at 5V, 1W into 8Ω	85% (typ)
■ Quiescent Power Supply Current at 3.6V supply	4mA
■ Power Output at $V_{DD} = 5\text{V}$, $R_L = 4\Omega$, THD $\leq 10\%$	2.5W (typ)
■ Power Output at $V_{DD} = 5\text{V}$, $R_L = 8\Omega$, THD $\leq 10\%$	1.5W (typ)
■ Shutdown current	0.03μA (typ)

Features

- Output Short Circuit Protection
- Stereo Class D operation
- No output filter required
- Logic selectable gain
- Independent shutdown control
- Minimum external components
- Click and Pop suppression
- Micro-power shutdown
- Available in space-saving 2mm x 2mm x 0.6mm micro SMD, and 4mm x 4mm x 0.8mm LLP packages

Applications

- Mobile phones
- PDAs
- Laptops

Typical Application

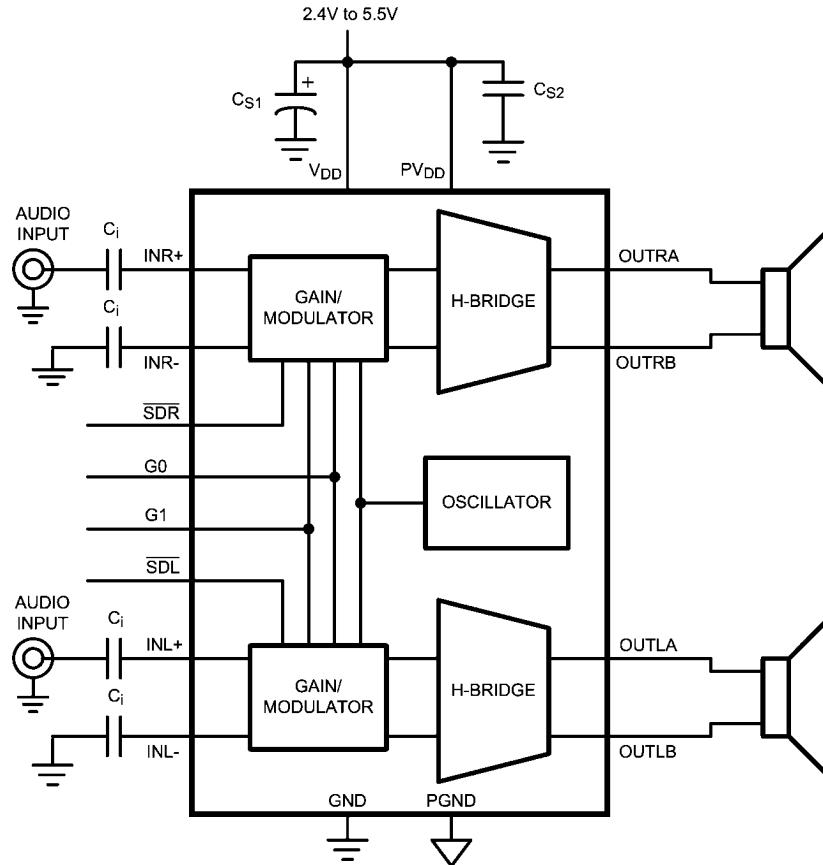

20167463

$C_i = 1 \mu\text{F}$
 $C_{S1} = 1 \mu\text{F}$
 $C_{S2} = 0.1 \mu\text{F}$

FIGURE 1. Typical Audio Amplifier Application Circuit

External Components Description

(Figure 1)

Components		Functional Description
1.	C_S	Supply bypass capacitor which provides power supply filtering. Refer to the Power Supply Bypassing section for information concerning proper placement and selection of the supply bypass capacitor.
2.	C_i	Input AC coupling capacitor which blocks the DC voltage at the amplifier's input terminals.

Connection Diagrams

TL Package (2mm x 2mm x 0.6mm)

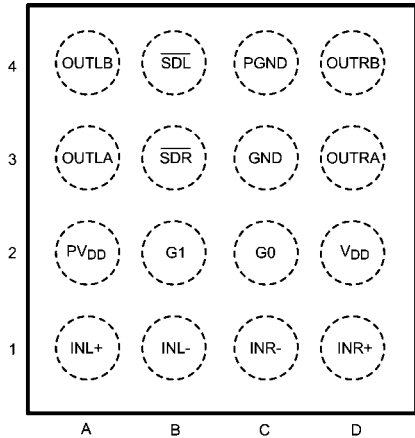

20167461

Top View
Order Number LM4674TL
See NS Package Number TL1611A

LM4674TL Markings

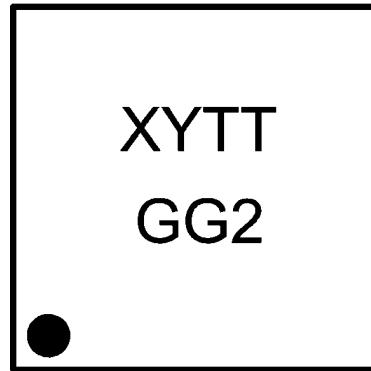

20167462

Top View
XY = 2 Digit date code
TT = Lot traceability
G = Boomer Family
G2 = LM4674TL

LLP Package (4mm x 4mm x 0.8mm)

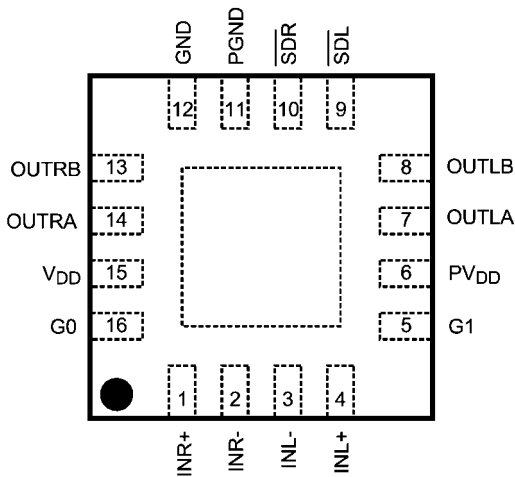

20167466

Top View
Order Number LM4674SQ
See NS Package Number SQA16A

LM4674SQ Markings

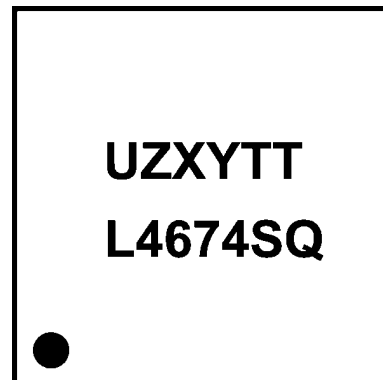

20167465

Top View
U = Wafer Fab Code
Z = Assembly Plant
XY = 2 Digit date code
TT = Lot traceability
L4674SQ = LM4674SQ

BUMP	PIN	NAME	FUNCTION
A1	4	INL+	Non-inverting left channel input
A2	6	PV _{DD}	Power V _{DD}
A3	7	OUTLA	Left channel output A
A4	8	OUTLB	Left channel output B
B1	3	INL-	Inverting left channel input
B2	5	G1	Gain setting input 1
B3	10	$\overline{\text{SDR}}$	Right channel shutdown input
B4	9	$\overline{\text{SDL}}$	Left channel shutdown input
C1	2	INR-	Inverting right channel input
C2	16	G0	Gain setting input 0
C3	12	GND	Ground
C4	11	PGND	Power Ground
D1	1	INR+	Non-inverting right channel input
D2	15	V _{DD}	Power Supply
D3	14	OUTRA	Right channel output A
D4	13	OUTRB	Right channel output B

Absolute Maximum Ratings (Notes 1, 2)

If Military/Aerospace specified devices are required, please contact the National Semiconductor Sales Office/Distributors for availability and specifications.

Supply Voltage (Note 1)	6.0V
Storage Temperature	-65°C to +150°C
Input Voltage	-0.3V to $V_{DD} + 0.3V$
Power Dissipation (Note 3)	Internally Limited
ESD Susceptibility, all other pins (Note 4)	2000V
ESD Susceptibility (Note 5)	200V

Junction Temperature (T_{JMAX})	150°C
Thermal Resistance	
θ_{JA} (μ SMD)	45.7°C/W
θ_{JA} (LLP)	38.9°C/W

Operating Ratings (Notes 1, 2)

Temperature Range	
$T_{MIN} \leq T_A \leq T_{MAX}$	-40°C \leq T_A \leq 85°C
Supply Voltage	2.4V \leq V_{DD} \leq 5.5V

Electrical Characteristics $V_{DD} = 3.6V$ (Notes 1, 2)

The following specifications apply for $A_V = 6dB$, $R_L = 15\mu H + 8\Omega + 15\mu H$, $f = 1kHz$ unless otherwise specified. Limits apply for $T_A = 25^\circ C$.

Symbol	Parameter	Conditions	LM4674		Units (Limits)
			Typical	Limit	
			(Note 6)	(Notes 7, 8)	
V_{OS}	Differential Output Offset Voltage	$V_{IN} = 0$, $V_{DD} = 2.4V$ to $5.0V$	5		mV
I_{DD}	Quiescent Power Supply Current	$V_{IN} = 0$, $R_L = \infty$, Both channels active, $V_{DD} = 3.6V$	4	6	mA
		$V_{IN} = 0$, $R_L = \infty$, Both channels active, $V_{DD} = 5V$	5	7.5	mA
I_{SD}	Shutdown Current	$V_{SDR} = V_{SDL} = GND$	0.03	1	μA
V_{SDIH}	Shutdown Voltage Input High			1.4	V (min)
V_{SDIL}	Shutdown Voltage Input Low			0.4	V (max)
T_{WU}	Wake Up Time	$V_{SDR/SDL} = 0.4V$	0.5		ms
A_V	Gain	$G0, G1 = GND$ $R_L = \infty$	6	6 ± 0.5	dB
		$G0 = V_{DD}$, $G1 = GND$ $R_L = \infty$	12	12 ± 0.5	dB
		$G0 = GND$, $G1 = V_{DD}$ $R_L = \infty$	18	18 ± 0.5	dB
		$G0, G1 = V_{DD}$ $R_L = \infty$	24	24 ± 0.5	dB
R_{IN}	Input Resistance	$A_V = 6dB$	28		$k\Omega$
		$A_V = 12dB$	18.75		$k\Omega$
		$A_V = 18dB$	11.25		$k\Omega$
		$A_V = 24dB$	6.25		$k\Omega$

Symbol	Parameter	Conditions	LM4674		Units (Limits)
			Typical	Limit	
			(Note 6)	(Notes 7, 8)	
P _O	Output Power	R _L = 15μH + 4Ω + 15μH, THD ≤ 10% f = 1kHz, 22kHz BW			
		V _{DD} = 5V	2.5		W
		V _{DD} = 3.6V	1.2		W
		V _{DD} = 2.5V	0.530		W
		R _L = 15μH + 8Ω + 15μH, THD ≤ 10% f = 1kHz, 22kHz BW			
		V _{DD} = 5V	1.5		W
		V _{DD} = 3.6V	0.78	0.6	W
		V _{DD} = 2.5V	0.350		W
		R _L = 15μH + 4Ω + 15μH, THD ≤ 1% f = 1kHz, 22kHz BW			
		V _{DD} = 5V	1.9		W
		V _{DD} = 3.6V	1		W
		V _{DD} = 2.5V	0.430		W
		R _L = 15μH + 8Ω + 15μH, THD = 1% f = 1kHz, 22kHz BW			
		V _{DD} = 5V	1.25		W
		V _{DD} = 3.6V	0.63		W
		V _{DD} = 2.5V	0.285		W
THD+N	Total Harmonic Distortion	P _O = 500mW, f = 1kHz, R _L = 8Ω	0.07		%
		P _O = 300mW, f = 1kHz, R _L = 8Ω	0.05		%
PSRR	Power Supply Rejection Ratio	V _{RIPPLE} = 200mV _{P-P} Sine, f _{RIPPLE} = 217Hz, Inputs AC GND, C ₁ = 1μF, input referred	75		dB
		V _{RIPPLE} = 1V _{P-P} Sine, f _{RIPPLE} = 1kHz, Inputs AC GND, C ₁ = 1μF, input referred	75		dB
CMRR	Common Mode Rejection Ratio	V _{RIPPLE} = 1V _{P-P} f _{RIPPLE} = 217Hz	67		dB
η	Efficiency	P _O = 1W, f = 1kHz, R _L = 8Ω, V _{DD} = 5V	85		%
Xtalk	Crosstalk	P _O = 500mW, f = 1kHz	84		dB
SNR	Signal to Noise Ratio	V _{DD} = 5V, P _O = 1W	96		dB
ε _{OS}	Output Noise	Input referred, A-Weighted Filter	20		μV

Note 1: All voltages are measured with respect to the ground pin, unless otherwise specified.

Note 2: *Absolute Maximum Ratings* indicate limits beyond which damage to the device may occur. *Operating Ratings* indicate conditions for which the device is functional, but do not guarantee specific performance limits. *Electrical Characteristics* state DC and AC electrical specifications under particular test conditions which guarantee specific performance limits. This assumes that the device is within the Operating Ratings. Specifications are not guaranteed for parameters where no limit is given, however, the typical value is a good indication of device performance.

Note 3: The maximum power dissipation must be derated at elevated temperatures and is dictated by T_{JMAX}, θ_{JA}, and the ambient temperature, T_A. The maximum allowable power dissipation is P_{DMAX} = (T_{JMAX} - T_A) / θ_{JA} or the number given in Absolute Maximum Ratings, whichever is lower. For the LM4674 see power derating currents for more information.

Note 4: Human body model, 100pF discharged through a 1.5kΩ resistor.

Note 5: Machine Model, 220pF–240pF discharged through all pins.

Note 6: Typicals are measured at 25°C and represent the parametric norm.

Note 7: Limits are guaranteed to National's AOQL (Average Outgoing Quality Level).

Note 8: Datasheet min/max specification limits are guaranteed by design, test, or statistical analysis.

Block Diagrams

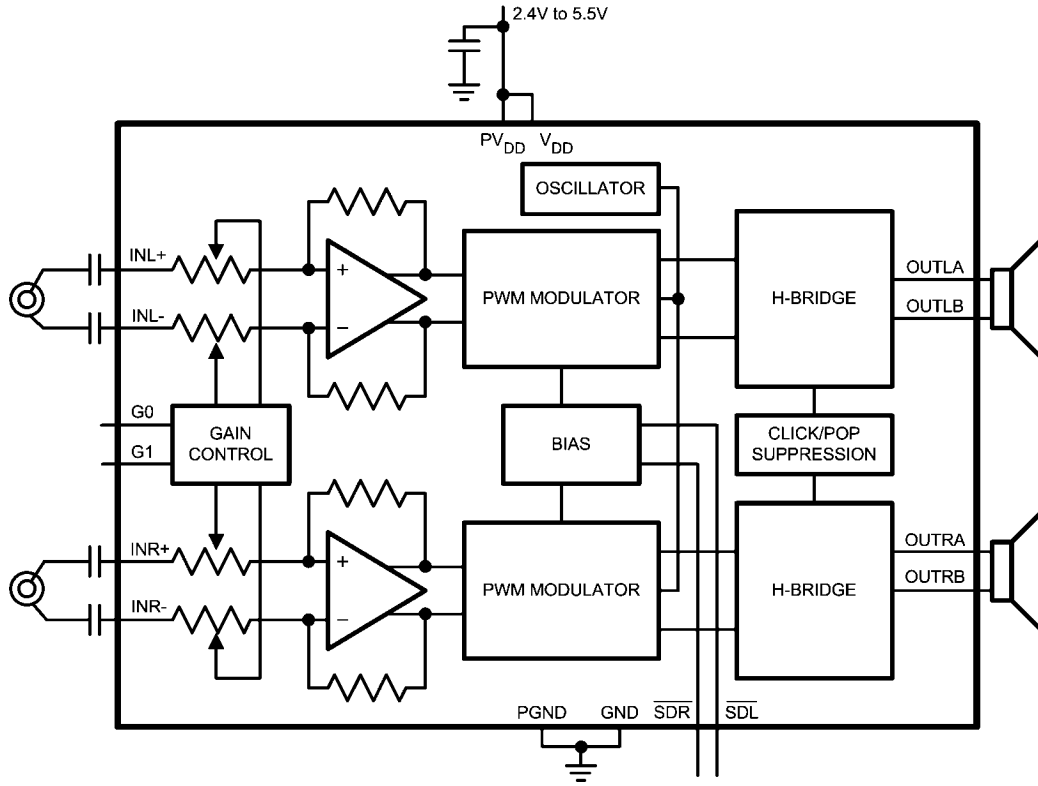

20167426

FIGURE 2. Differential Input Configuration

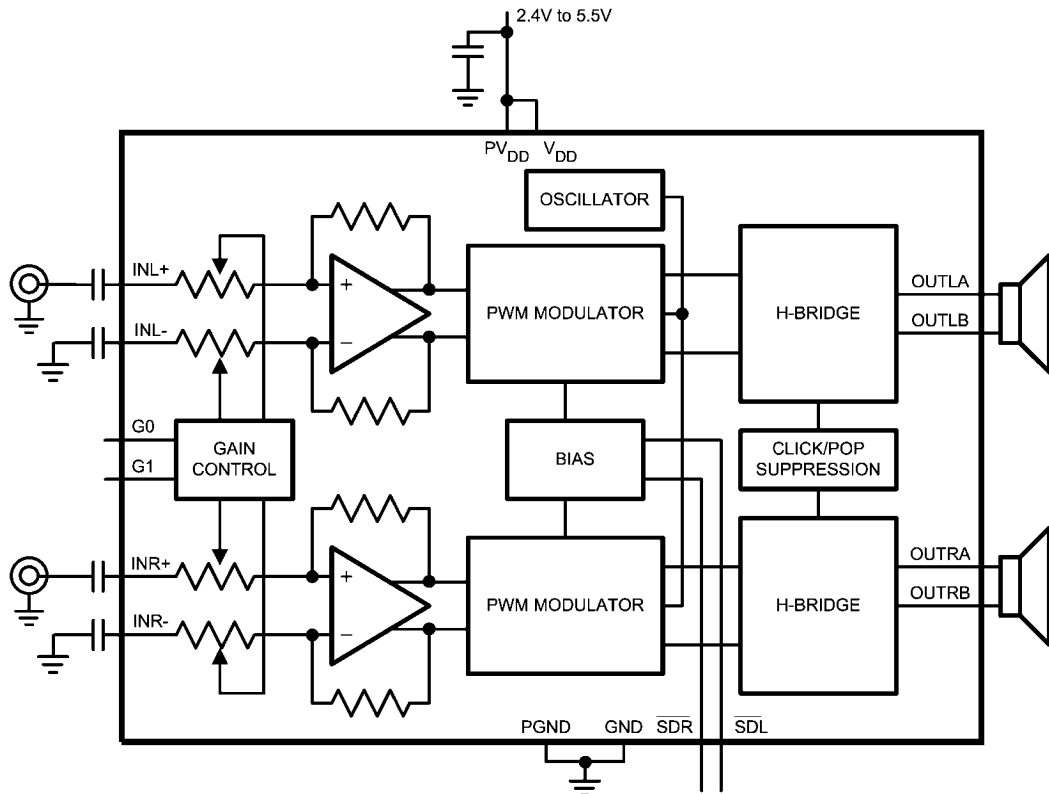

20167464

FIGURE 3. Single-Ended Input Configuration

Typical Performance Characteristics

THD+N vs Output Power
 $f = 1\text{kHz}$, $A_V = 24\text{dB}$, $R_L = 8\Omega$

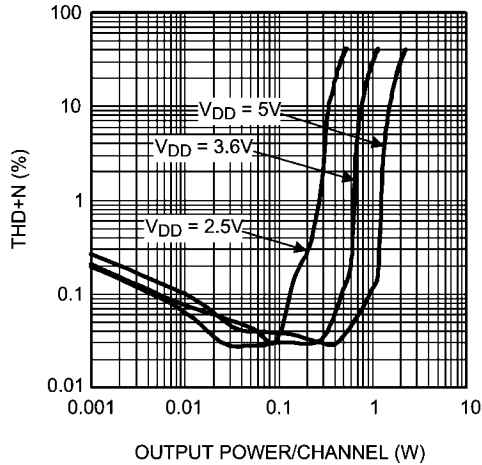

THD+N vs Output Power
 $f = 1\text{kHz}$, $A_V = 6\text{dB}$, $R_L = 8\Omega$

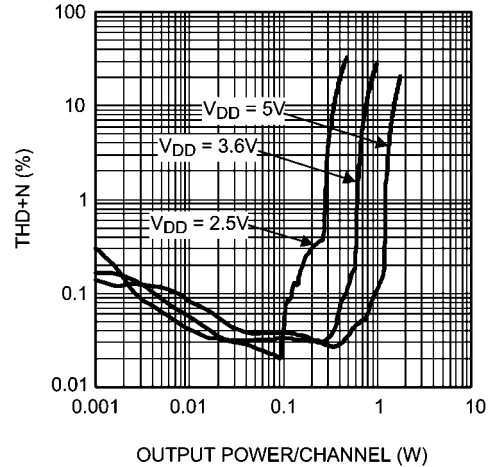

THD+N vs Output Power
 $f = 1\text{kHz}$, $A_V = 24\text{dB}$, $R_L = 4\Omega$

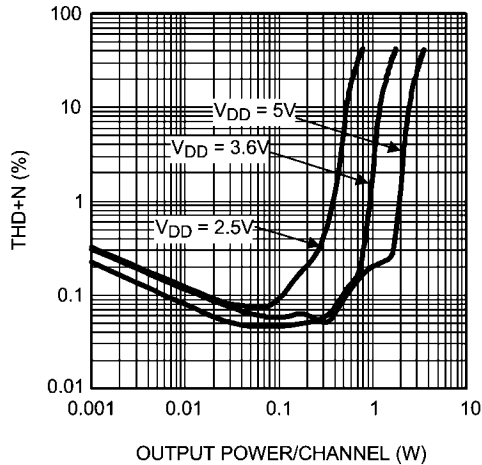

THD+N vs Output Power
 $f = 1\text{kHz}$, $A_V = 6\text{dB}$, $R_L = 4\Omega$

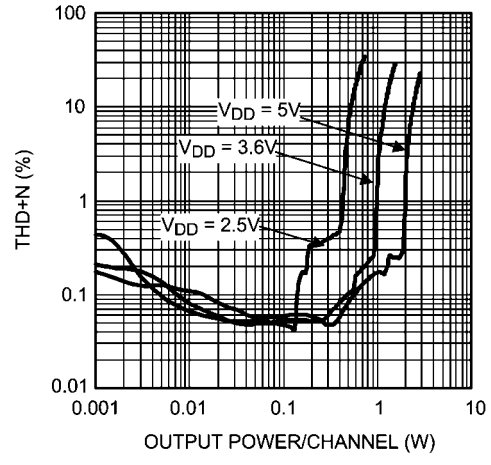

THD+N vs Frequency
 $V_{DD} = 2.5\text{V}$, $P_{OUT} = 100\text{mW/ch}$, $R_L = 8\Omega$

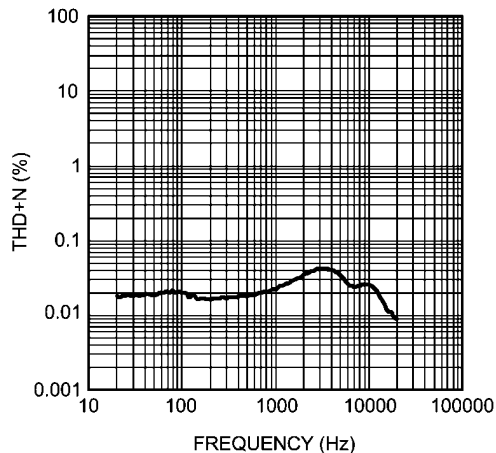

THD+N vs Frequency
 $V_{DD} = 3.6\text{V}$, $P_{OUT} = 250\text{mW/ch}$, $R_L = 8\Omega$

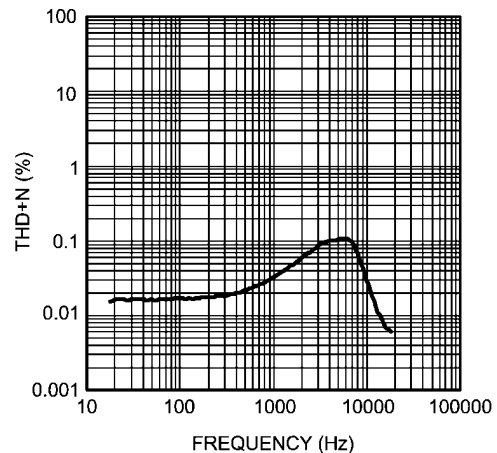

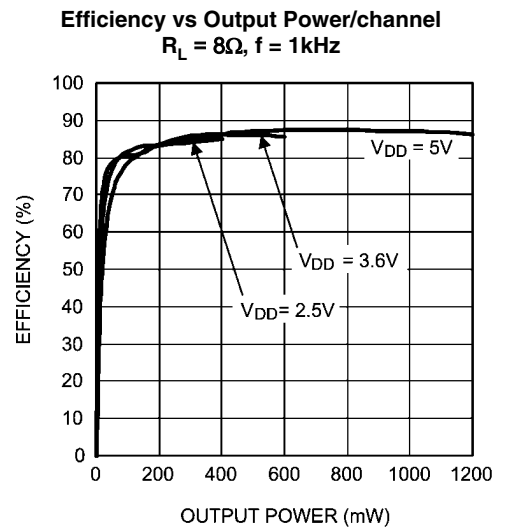
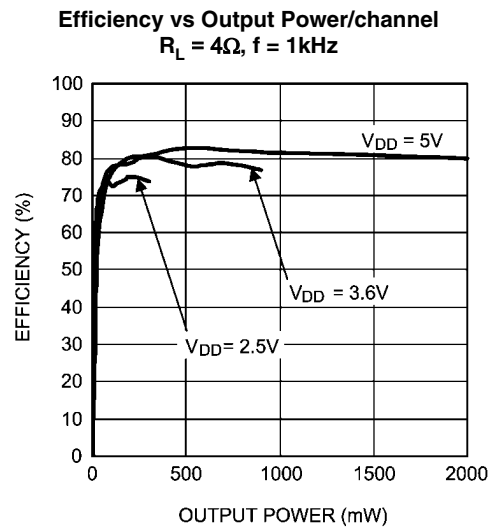
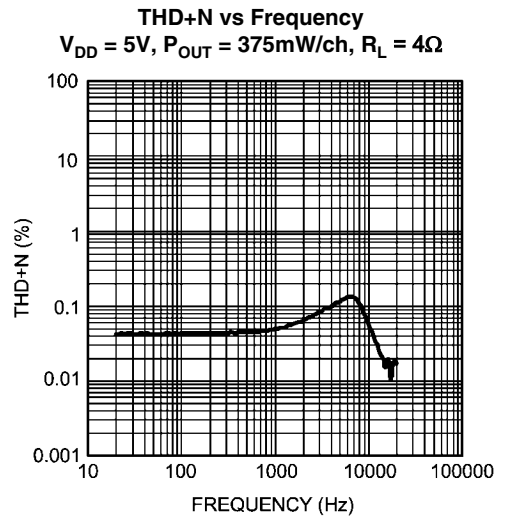
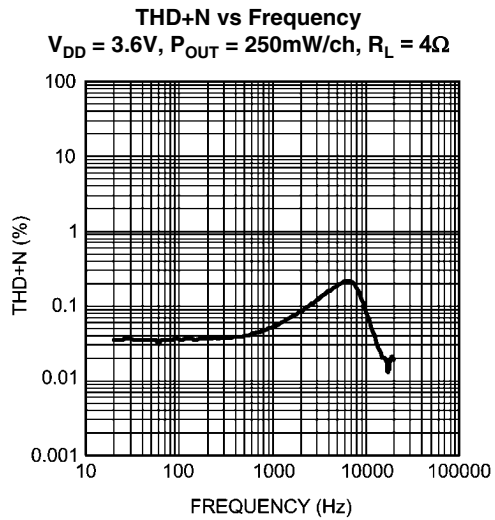
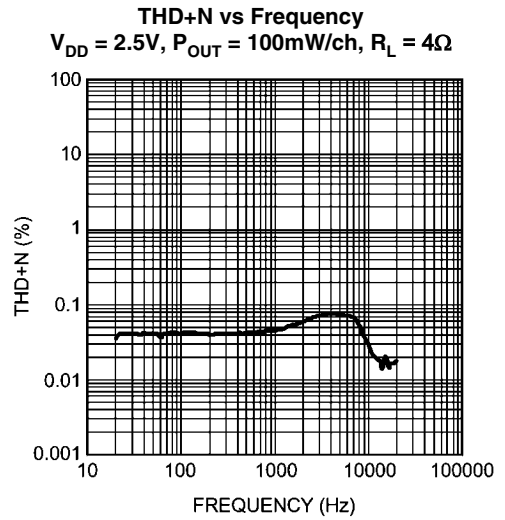
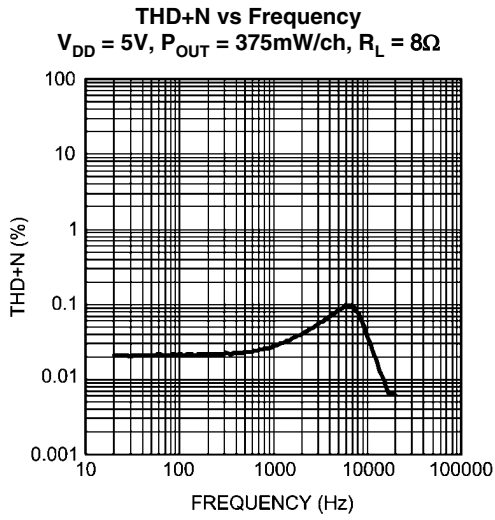

Power Dissipation vs Output Power
 $R_L = 4\Omega, f = 1\text{kHz}$

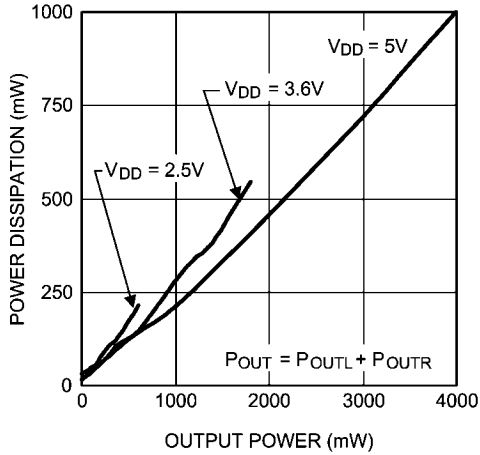

20167451

Power Dissipation vs Output Power
 $R_L = 8\Omega, f = 1\text{kHz}$

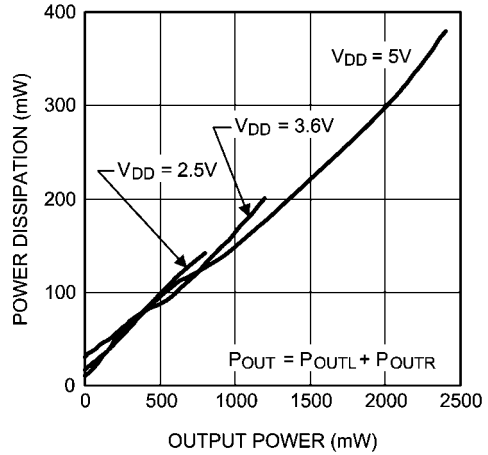

20167452

Output Power/channel vs Supply Voltage
 $R_L = 4\Omega, f = 1\text{kHz}$

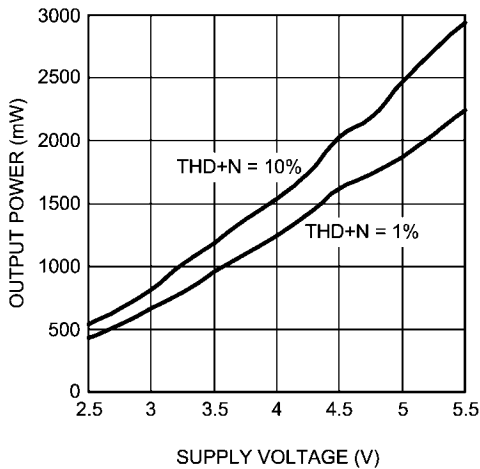

20167453

Output Power/channel vs Supply Voltage
 $R_L = 8\Omega, f = 1\text{kHz}$

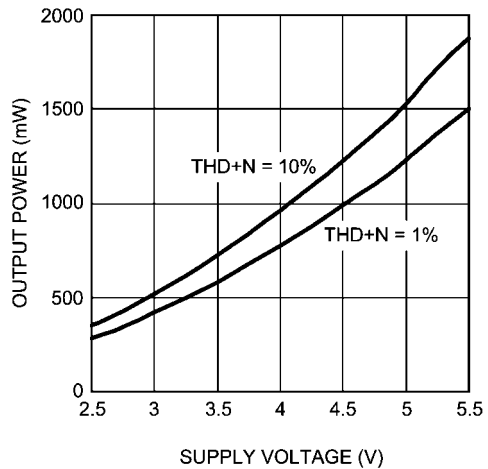

20167454

PSRR vs Frequency
 $V_{DD} = 3.6\text{V}, V_{RIPPLE} = 200\text{mV}_{P-P}, R_L = 8\Omega$

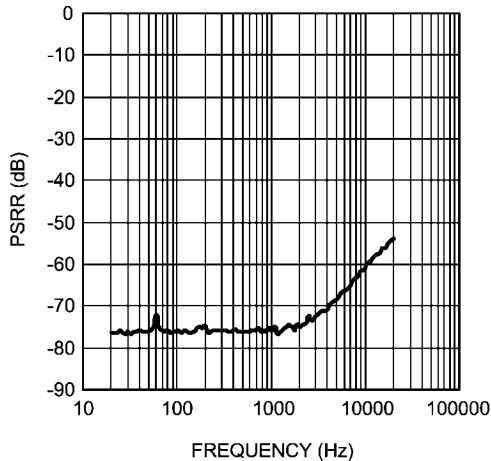

20167455

Crosstalk vs Frequency
 $V_{DD} = 3.6\text{V}, V_{RIPPLE} = 1\text{V}_{P-P}, R_L = 8\Omega$

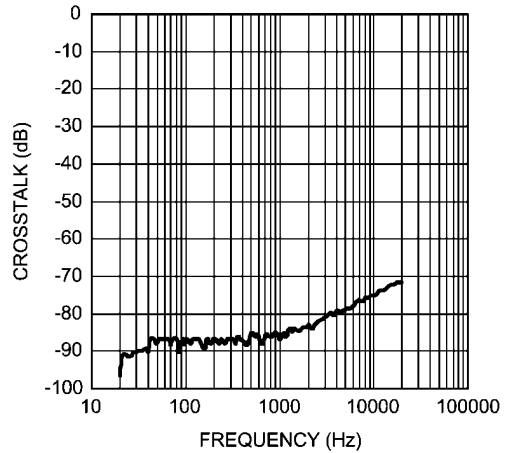

20167422

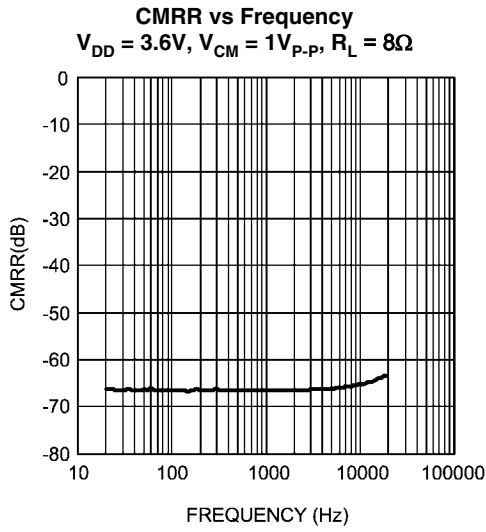

20167457

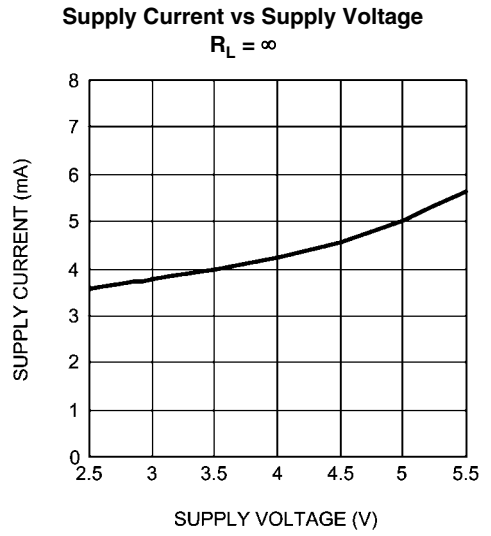

20167458

Application Information

GENERAL AMPLIFIER FUNCTION

The LM4674 stereo Class D audio power amplifier features a filterless modulation scheme that reduces external component count, conserving board space and reducing system cost. The outputs of the device transition from V_{DD} to GND with a 300kHz switching frequency. With no signal applied, the outputs for each channel switch with a 50% duty cycle, in phase, causing the two outputs to cancel. This cancellation results in no net voltage across the speaker, thus there is no current to the load in the idle state.

With the input signal applied, the duty cycle (pulse width) of the LM4674 outputs changes. For increasing output voltage, the duty cycle of the A output increases, while the duty cycle of the B output decreases for each channel. For decreasing output voltages, the converse occurs. The difference between the two pulse widths yields the differential output voltage.

DIFFERENTIAL AMPLIFIER EXPLANATION

As logic supplies continue to shrink, system designers are increasingly turning to differential analog signal handling to preserve signal to noise ratios with restricted voltage signs. The LM4674 features two fully differential amplifiers. A differential amplifier amplifies the difference between the two input signals. Traditional audio power amplifiers have typically offered only single-ended inputs resulting in a 6dB reduction of SNR relative to differential inputs. The LM4674 also offers the possibility of DC input coupling which eliminates the input coupling capacitors. A major benefit of the fully differential amplifier is the improved common mode rejection ratio (CMRR) over single ended input amplifiers. The increased CMRR of the differential amplifier reduces sensitivity to ground offset related noise injection, especially important in noisy systems.

POWER DISSIPATION AND EFFICIENCY

The major benefit of a Class D amplifier is increased efficiency versus a class AB amplifier. The efficiency of the LM4674 is attributed to the region of operation of the transistors in the output stage. The Class D output stage acts as current steering switches, consuming negligible amounts of power compared to their Class AB counterparts. Most of the power loss associated with the output stage is due to the IR loss of the MOSFET on-resistance ($R_{DS(ON)}$), along with switching losses due to gate charge.

SHUTDOWN FUNCTION

The LM4674 features independent left and right channel shutdown controls, allowing each channel to be disabled independently. \overline{SDR} controls the right channel, while \overline{SDL} controls the left channel. Driving either low disables the corresponding channel.

It is best to switch between ground and V_{DD} for minimum current consumption while in shutdown. The LM4674 may be disabled with shutdown voltages in between GND and V_{DD} , the idle current will be greater than the typical 0.03 μ A value. For logic levels between GND and V_{DD} bypass \overline{SD}_- with a 0.1 μ F capacitor.

The LM4674 shutdown inputs have internal pulldown resistors. The purpose of these resistors is to eliminate any un-

wanted state changes when \overline{SD}_- is floating. To minimize shutdown current, \overline{SD}_- should be driven to GND or left floating. If \overline{SD}_- is not driven to GND or floating, an increase in shutdown supply current will be noticed.

SINGLE-ENDED AUDIO AMPLIFIER CONFIGURATION

The LM4674 is compatible with single-ended sources. When configured for single-ended inputs, input capacitors must be used to block any DC component at the input of the device. Figure 3 shows the typical single-ended applications circuit.

AUDIO AMPLIFIER POWER SUPPLY BYPASSING/FILTERING

Proper power supply bypassing is critical for low noise performance and high PSRR. Place the supply bypass capacitor as close to the device as possible. Typical applications employ a voltage regulator with 10 μ F and 0.1 μ F bypass capacitors that increase supply stability. These capacitors do not eliminate the need for bypassing of the LM4674 supply pins. A 1 μ F capacitor is recommended.

AUDIO AMPLIFIER INPUT CAPACITOR SELECTION

Input capacitors may be required for some applications, or when the audio source is single-ended. Input capacitors block the DC component of the audio signal, eliminating any conflict between the DC component of the audio source and the bias voltage of the LM4674. The input capacitors create a high-pass filter with the input resistance R_i . The -3dB point of the high pass filter is found using Equation 1 below.

$$f = 1 / 2\pi R_i C_i \quad (1)$$

The values for R_i can be found in the EC table for each gain setting.

The input capacitors can also be used to remove low frequency content from the audio signal. Small speakers cannot reproduce, and may even be damaged by low frequencies. High pass filtering the audio signal helps protect the speakers. When the LM4674 is using a single-ended source, power supply noise on the ground is seen as an input signal. Setting the high-pass filter point above the power supply noise frequencies, 217 Hz in a GSM phone, for example, filters out the noise such that it is not amplified and heard on the output. Capacitors with a tolerance of 10% or better are recommended for impedance matching and improved CMRR and PSRR.

AUDIO AMPLIFIER GAIN SETTING

The LM4674 features four internally configured gain settings. The device gain is selected through the two logic inputs, G0 and G1. The gain settings are as shown in the following table.

LOGIC INPUT		GAIN	
G1	G0	V/V	dB
0	0	2	6
0	1	4	12
1	0	8	18
1	1	16	24

PCB LAYOUT GUIDELINES

As output power increases, interconnect resistance (PCB traces and wires) between the amplifier, load and power supply create a voltage drop. The voltage loss due to the traces between the LM4674 and the load results in lower output power and decreased efficiency. Higher trace resistance between the supply and the LM4674 has the same effect as a poorly regulated supply, increasing ripple on the supply line, and reducing peak output power. The effects of residual trace resistance increases as output current increases due to higher output power, decreased load impedance or both. To maintain the highest output voltage swing and corresponding peak output power, the PCB traces that connect the output pins to the load and the supply pins to the power supply should be as wide as possible to minimize trace resistance.

The use of power and ground planes will give the best THD +N performance. In addition to reducing trace resistance, the

use of power planes creates parasitic capacitors that help to filter the power supply line.

The inductive nature of the transducer load can also result in overshoot on one or both edges, clamped by the parasitic diodes to GND and VDD in each case. From an EMI standpoint, this is an aggressive waveform that can radiate or conduct to other components in the system and cause interference. It is essential to keep the power and output traces short and well shielded if possible. Use of ground planes beads and micro-strip layout techniques are all useful in preventing unwanted interference.

As the distance from the LM4674 and the speaker increases, the amount of EMI radiation increases due to the output wires or traces acting as antennas become more efficient with length. Ferrite chip inductors placed close to the LM4674 outputs may be needed to reduce EMI radiation.

LM4674TL Demo Board Schematic

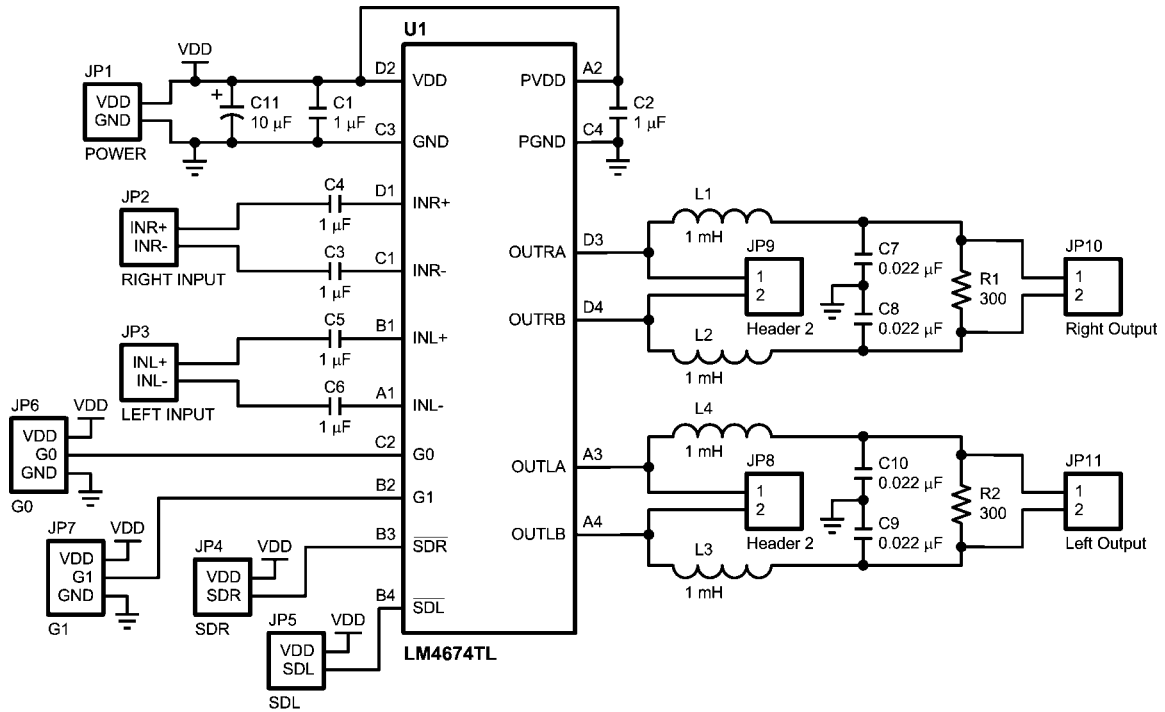

LM4674TL Demo Board Schematic

20167474

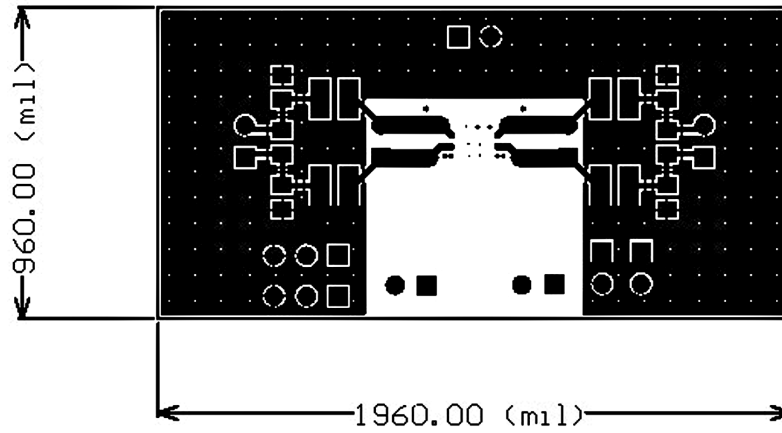

Layer 4

20167479

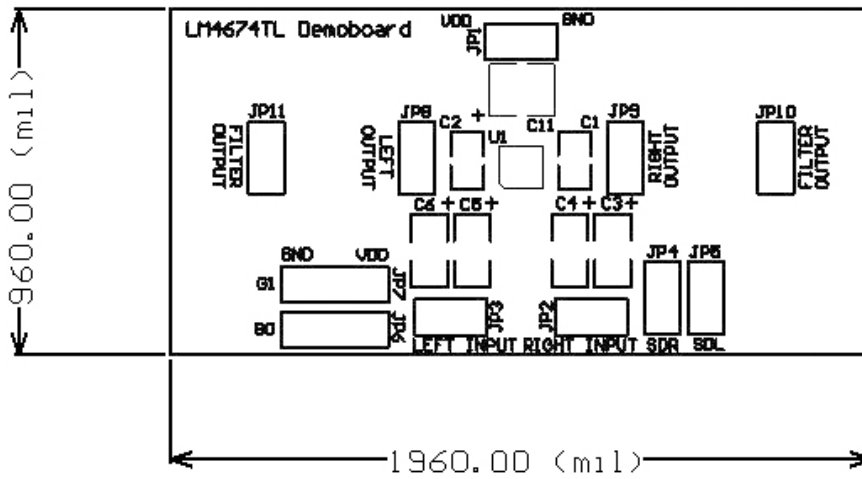

Top Silkscreen

20167480

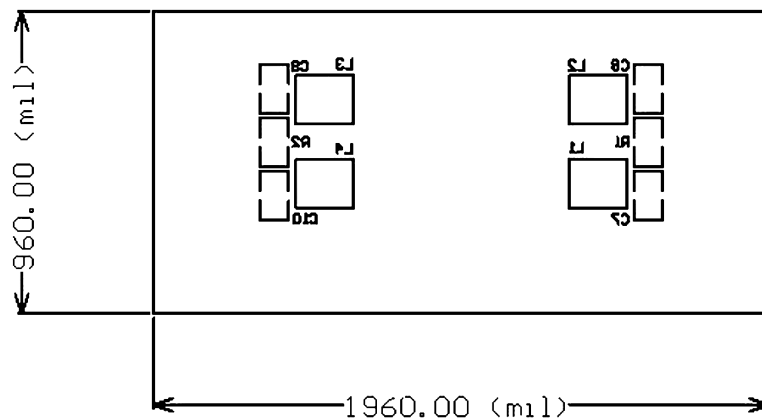

Bottom Silkscreen

20167475

LM4674SQ Demo Board Schematic

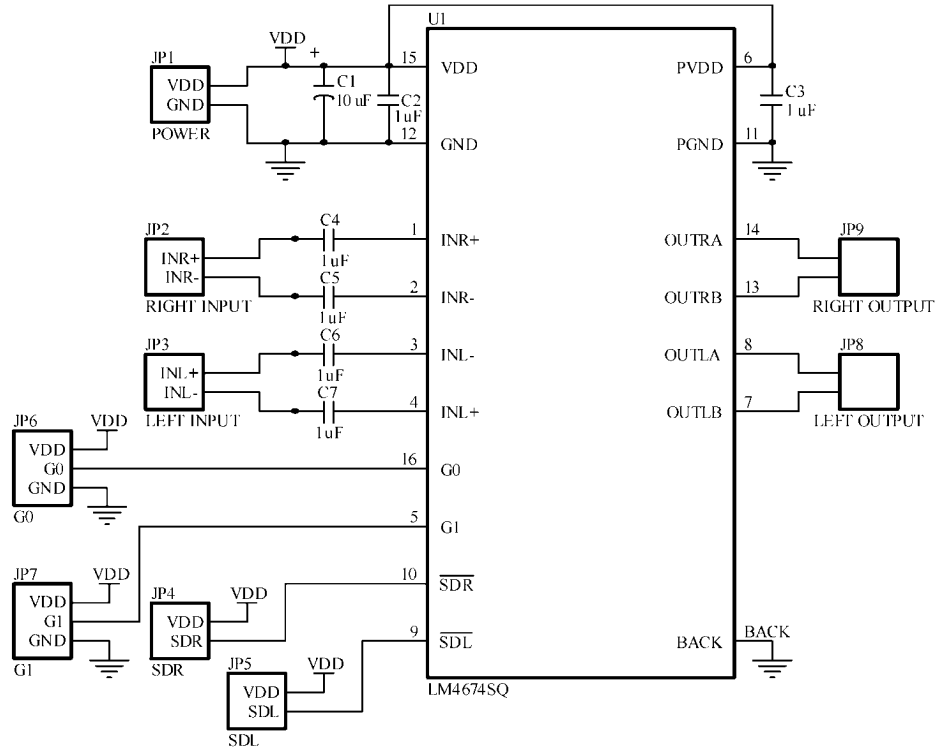

LM4674SQ Demo Board Schematic

20167481

LM4674SQ Demonstration Board Layout

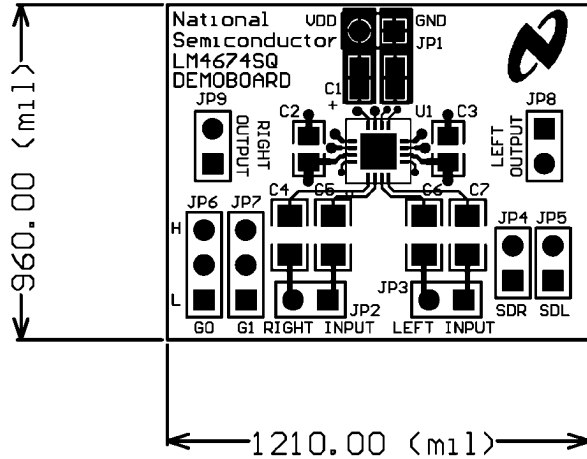

Layer 1

20167485

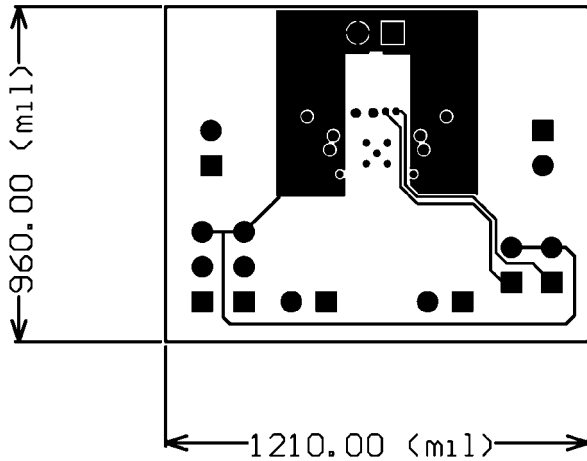

Layer 2

20167483

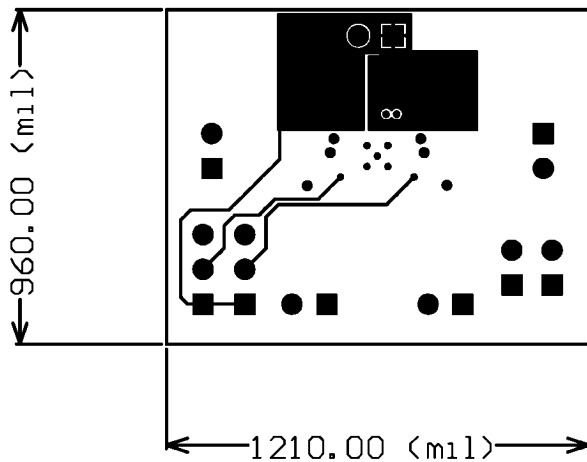

Layer 3

20167484

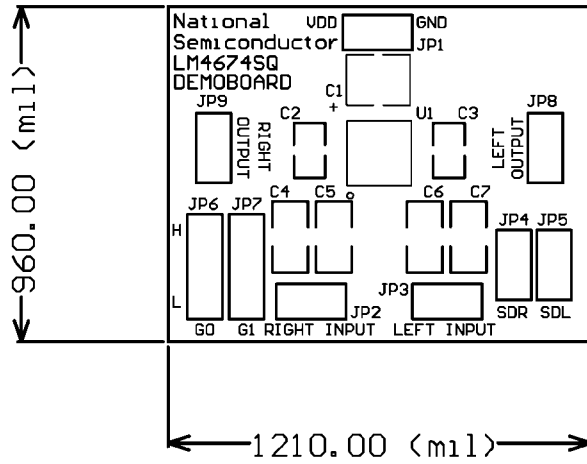

Top Silkscreen

20167486

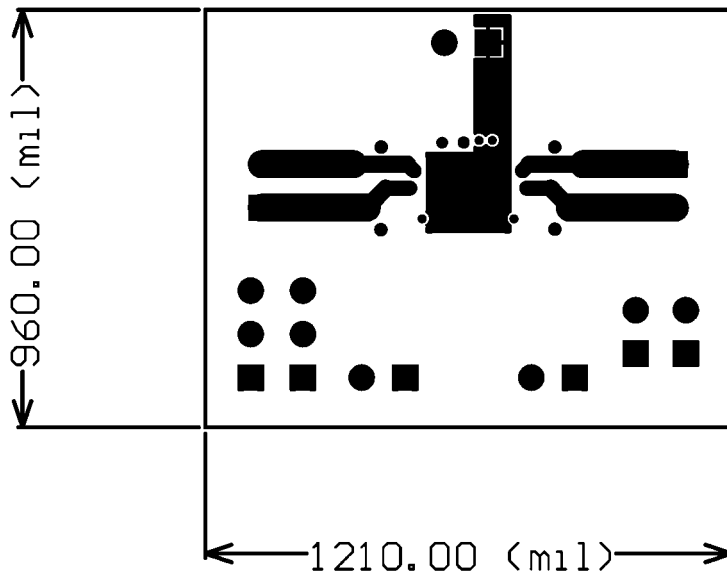

Bottom Layer

20167487

Revision Table

Rev	Date	Description
1.0	12/16/06	Initial release.
1.1	05/17/06	Added the LLP package.
1.2	05/31/06	Added the LLP markings.
1.3	09/05/06	Added "No Load" in the Conditions on Av (3.6V table).
1.4	09/21/06	Edited graphics (26, 38, 60) and input some text edits.
1.5	09/27/06	Edited Figure 1 (page 2), TL and LLP pkg/markings drawings (page 3). Input text edits.
1.6	07/13/07	Added the TL and SQ demo boards and schematics diagrams.
1.7	10/30/07	Updated the SQ schematic diagram and replaced the demo boards.
1.8	07/02/08	Text edits (under SHUTDOWN FUNCTION).

Physical Dimensions inches (millimeters) unless otherwise noted

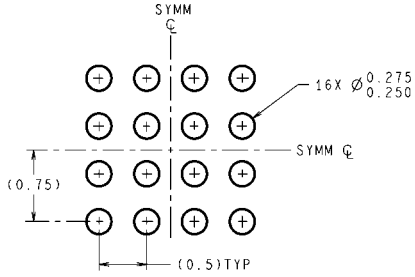

DIMENSIONS ARE IN MILLIMETERS
DIMENSIONS IN () FOR REFERENCE ONLY

LAND PATTERN RECOMMENDATION

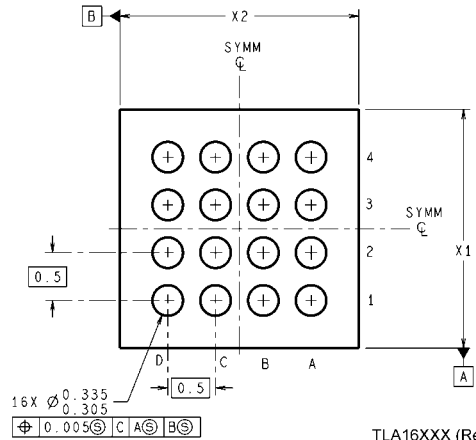
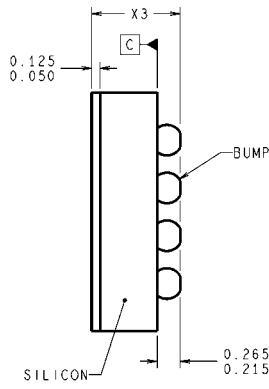
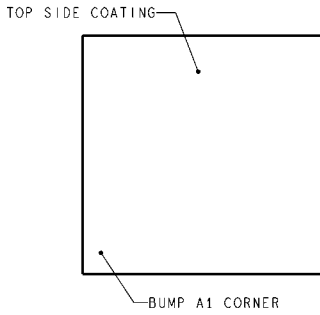

TLA16XXX (Rev C)

16 Bump micro SMD
Order Number LM4674TL
NS Package Number TLA1611A
X1 = 2mm X2 = 2mm X3 = 0.6mm

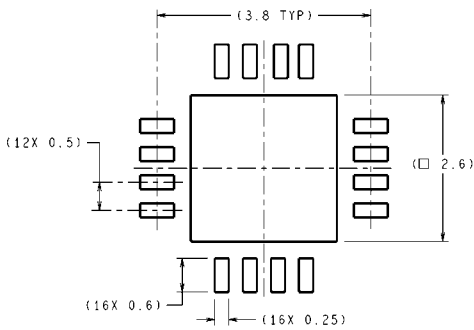

DIMENSIONS ARE IN MILLIMETERS
DIMENSIONS IN () FOR REFERENCE ONLY

RECOMMENDED LAND PATTERN

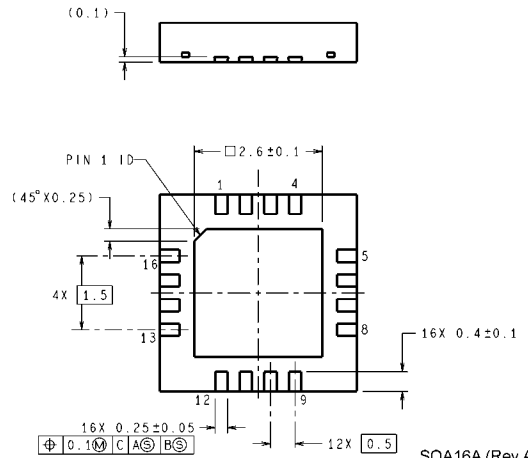
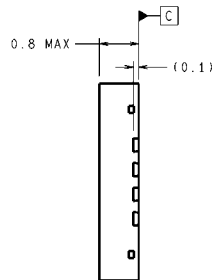
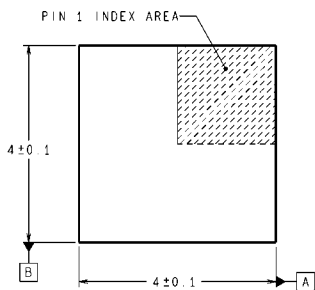

SQA16A (Rev A)

LLP Package
Order Number LM4674SQ
NS Package Number SQA16A

Notes

Notes

For more National Semiconductor product information and proven design tools, visit the following Web sites at:

Products		Design Support	
Amplifiers	www.national.com/amplifiers	WEBENCH	www.national.com/webench
Audio	www.national.com/audio	Analog University	www.national.com/AU
Clock Conditioners	www.national.com/timing	App Notes	www.national.com/appnotes
Data Converters	www.national.com/adc	Distributors	www.national.com/contacts
Displays	www.national.com/displays	Green Compliance	www.national.com/quality/green
Ethernet	www.national.com/ethernet	Packaging	www.national.com/packaging
Interface	www.national.com/interface	Quality and Reliability	www.national.com/quality
LVDS	www.national.com/lvds	Reference Designs	www.national.com/refdesigns
Power Management	www.national.com/power	Feedback	www.national.com/feedback
Switching Regulators	www.national.com/switchers		
LDOs	www.national.com/lido		
LED Lighting	www.national.com/led		
PowerWise	www.national.com/powerwise		
Serial Digital Interface (SDI)	www.national.com/sdi		
Temperature Sensors	www.national.com/tempsensors		
Wireless (PLL/VCO)	www.national.com/wireless		

THE CONTENTS OF THIS DOCUMENT ARE PROVIDED IN CONNECTION WITH NATIONAL SEMICONDUCTOR CORPORATION ("NATIONAL") PRODUCTS. NATIONAL MAKES NO REPRESENTATIONS OR WARRANTIES WITH RESPECT TO THE ACCURACY OR COMPLETENESS OF THE CONTENTS OF THIS PUBLICATION AND RESERVES THE RIGHT TO MAKE CHANGES TO SPECIFICATIONS AND PRODUCT DESCRIPTIONS AT ANY TIME WITHOUT NOTICE. NO LICENSE, WHETHER EXPRESS, IMPLIED, ARISING BY ESTOPPEL OR OTHERWISE, TO ANY INTELLECTUAL PROPERTY RIGHTS IS GRANTED BY THIS DOCUMENT.

TESTING AND OTHER QUALITY CONTROLS ARE USED TO THE EXTENT NATIONAL DEEMS NECESSARY TO SUPPORT NATIONAL'S PRODUCT WARRANTY. EXCEPT WHERE MANDATED BY GOVERNMENT REQUIREMENTS, TESTING OF ALL PARAMETERS OF EACH PRODUCT IS NOT NECESSARILY PERFORMED. NATIONAL ASSUMES NO LIABILITY FOR APPLICATIONS ASSISTANCE OR BUYER PRODUCT DESIGN. BUYERS ARE RESPONSIBLE FOR THEIR PRODUCTS AND APPLICATIONS USING NATIONAL COMPONENTS. PRIOR TO USING OR DISTRIBUTING ANY PRODUCTS THAT INCLUDE NATIONAL COMPONENTS, BUYERS SHOULD PROVIDE ADEQUATE DESIGN, TESTING AND OPERATING SAFEGUARDS.

EXCEPT AS PROVIDED IN NATIONAL'S TERMS AND CONDITIONS OF SALE FOR SUCH PRODUCTS, NATIONAL ASSUMES NO LIABILITY WHATSOEVER, AND NATIONAL DISCLAIMS ANY EXPRESS OR IMPLIED WARRANTY RELATING TO THE SALE AND/OR USE OF NATIONAL PRODUCTS INCLUDING LIABILITY OR WARRANTIES RELATING TO FITNESS FOR A PARTICULAR PURPOSE, MERCHANTABILITY, OR INFRINGEMENT OF ANY PATENT, COPYRIGHT OR OTHER INTELLECTUAL PROPERTY RIGHT.

LIFE SUPPORT POLICY

NATIONAL'S PRODUCTS ARE NOT AUTHORIZED FOR USE AS CRITICAL COMPONENTS IN LIFE SUPPORT DEVICES OR SYSTEMS WITHOUT THE EXPRESS PRIOR WRITTEN APPROVAL OF THE CHIEF EXECUTIVE OFFICER AND GENERAL COUNSEL OF NATIONAL SEMICONDUCTOR CORPORATION. As used herein:

Life support devices or systems are devices which (a) are intended for surgical implant into the body, or (b) support or sustain life and whose failure to perform when properly used in accordance with instructions for use provided in the labeling can be reasonably expected to result in a significant injury to the user. A critical component is any component in a life support device or system whose failure to perform can be reasonably expected to cause the failure of the life support device or system or to affect its safety or effectiveness.

National Semiconductor and the National Semiconductor logo are registered trademarks of National Semiconductor Corporation. All other brand or product names may be trademarks or registered trademarks of their respective holders.

Copyright© 2008 National Semiconductor Corporation

For the most current product information visit us at www.national.com



**National Semiconductor
Americas Technical
Support Center**
Email: support@nsc.com
Tel: 1-800-272-9959

**National Semiconductor Europe
Technical Support Center**
Email: europe.support@nsc.com
German Tel: +49 (0) 180 5010 771
English Tel: +44 (0) 870 850 4288

**National Semiconductor Asia
Pacific Technical Support Center**
Email: ap.support@nsc.com

**National Semiconductor Japan
Technical Support Center**
Email: jpn.feedback@nsc.com

IMPORTANT NOTICE

Texas Instruments Incorporated and its subsidiaries (TI) reserve the right to make corrections, modifications, enhancements, improvements, and other changes to its products and services at any time and to discontinue any product or service without notice. Customers should obtain the latest relevant information before placing orders and should verify that such information is current and complete. All products are sold subject to TI's terms and conditions of sale supplied at the time of order acknowledgment.

TI warrants performance of its hardware products to the specifications applicable at the time of sale in accordance with TI's standard warranty. Testing and other quality control techniques are used to the extent TI deems necessary to support this warranty. Except where mandated by government requirements, testing of all parameters of each product is not necessarily performed.

TI assumes no liability for applications assistance or customer product design. Customers are responsible for their products and applications using TI components. To minimize the risks associated with customer products and applications, customers should provide adequate design and operating safeguards.

TI does not warrant or represent that any license, either express or implied, is granted under any TI patent right, copyright, mask work right, or other TI intellectual property right relating to any combination, machine, or process in which TI products or services are used. Information published by TI regarding third-party products or services does not constitute a license from TI to use such products or services or a warranty or endorsement thereof. Use of such information may require a license from a third party under the patents or other intellectual property of the third party, or a license from TI under the patents or other intellectual property of TI.

Reproduction of TI information in TI data books or data sheets is permissible only if reproduction is without alteration and is accompanied by all associated warranties, conditions, limitations, and notices. Reproduction of this information with alteration is an unfair and deceptive business practice. TI is not responsible or liable for such altered documentation. Information of third parties may be subject to additional restrictions.

Resale of TI products or services with statements different from or beyond the parameters stated by TI for that product or service voids all express and any implied warranties for the associated TI product or service and is an unfair and deceptive business practice. TI is not responsible or liable for any such statements.

TI products are not authorized for use in safety-critical applications (such as life support) where a failure of the TI product would reasonably be expected to cause severe personal injury or death, unless officers of the parties have executed an agreement specifically governing such use. Buyers represent that they have all necessary expertise in the safety and regulatory ramifications of their applications, and acknowledge and agree that they are solely responsible for all legal, regulatory and safety-related requirements concerning their products and any use of TI products in such safety-critical applications, notwithstanding any applications-related information or support that may be provided by TI. Further, Buyers must fully indemnify TI and its representatives against any damages arising out of the use of TI products in such safety-critical applications.

TI products are neither designed nor intended for use in military/aerospace applications or environments unless the TI products are specifically designated by TI as military-grade or "enhanced plastic." Only products designated by TI as military-grade meet military specifications. Buyers acknowledge and agree that any such use of TI products which TI has not designated as military-grade is solely at the Buyer's risk, and that they are solely responsible for compliance with all legal and regulatory requirements in connection with such use.

TI products are neither designed nor intended for use in automotive applications or environments unless the specific TI products are designated by TI as compliant with ISO/TS 16949 requirements. Buyers acknowledge and agree that, if they use any non-designated products in automotive applications, TI will not be responsible for any failure to meet such requirements.

Following are URLs where you can obtain information on other Texas Instruments products and application solutions:

Products

Audio	www.ti.com/audio
Amplifiers	amplifier.ti.com
Data Converters	dataconverter.ti.com
DLP® Products	www.dlp.com
DSP	dsp.ti.com
Clocks and Timers	www.ti.com/clocks
Interface	interface.ti.com
Logic	logic.ti.com
Power Mgmt	power.ti.com
Microcontrollers	microcontroller.ti.com
RFID	www.ti-rfid.com
OMAP Mobile Processors	www.ti.com/omap
Wireless Connectivity	www.ti.com/wirelessconnectivity

Applications

Communications and Telecom	www.ti.com/communications
Computers and Peripherals	www.ti.com/computers
Consumer Electronics	www.ti.com/consumer-apps
Energy and Lighting	www.ti.com/energy
Industrial	www.ti.com/industrial
Medical	www.ti.com/medical
Security	www.ti.com/security
Space, Avionics and Defense	www.ti.com/space-avionics-defense
Transportation and Automotive	www.ti.com/automotive
Video and Imaging	www.ti.com/video

TI E2E Community Home Page

e2e.ti.com

Mailing Address: Texas Instruments, Post Office Box 655303, Dallas, Texas 75265
Copyright © 2011, Texas Instruments Incorporated

www.BDTIC.com/TI