

LM4846

*LM4846 Output Capacitor-less Audio Subsystem with Programmable National
3D*



Literature Number: SNAS342C

www.BDTIC.com/TI

LM4846 **Boomer**[®] Audio Power Amplifier Series

Output Capacitor-less Audio Subsystem with Programmable National 3D

General Description

The LM4846 is an audio power amplifier capable of delivering 500mW of continuous average power into a mono 8 Ω bridged-tied load (BTL) with 1% THD+N, 25mW per channel of continuous average power into stereo 32 Ω single-ended (SE) loads with 1% THD+N, or an output capacitor-less (OCL) configuration with identical specification as the SE configuration, from a 3.3V power supply.

The LM4846 features a 32-step digital volume control and eight distinct output modes. The digital volume control, 3D enhancement, and output modes (mono/SE/OCL) are programmed through a two-wire I²C or a three-wire SPI compatible interface that allows flexibility in routing and mixing audio channels. The LM4846 has three input channels: one pair for a two-channel stereo signal and the third for a single-channel mono input.

The LM4846 is designed for cellular phone, PDA, and other portable handheld applications. It delivers high quality output power from a surface-mount package and requires only seven external components in the OCL mode (two additional components in SE mode).

Key Specifications

■ THD+N at 1kHz, 500mW into 8 Ω BTL (3.3V)	1.0% (typ)
■ THD+N at 1kHz, 30mW into 32 Ω SE (3.3V)	1.0% (typ)
■ Single Supply Operation (V_{DD})	2.7 to 5.5V
■ I ² C/SPI Single Supply Operation	2.2 to 5.5V

Features

- I²C/SPI Control Interface
- I²C/SPI programmable National 3D Audio
- I²C/SPI controlled 32 step digital volume control (-54dB to +18dB)
- Three independent volume channels (Left, Right, Mono)
- Eight distinct output modes
- micro SMD surface mount packaging
- "Click and Pop" suppression circuitry
- Thermal shutdown protection
- Low shutdown current (0.1 μ A, typ)

Applications

- Mobile Phones
- PDAs

Typical Application

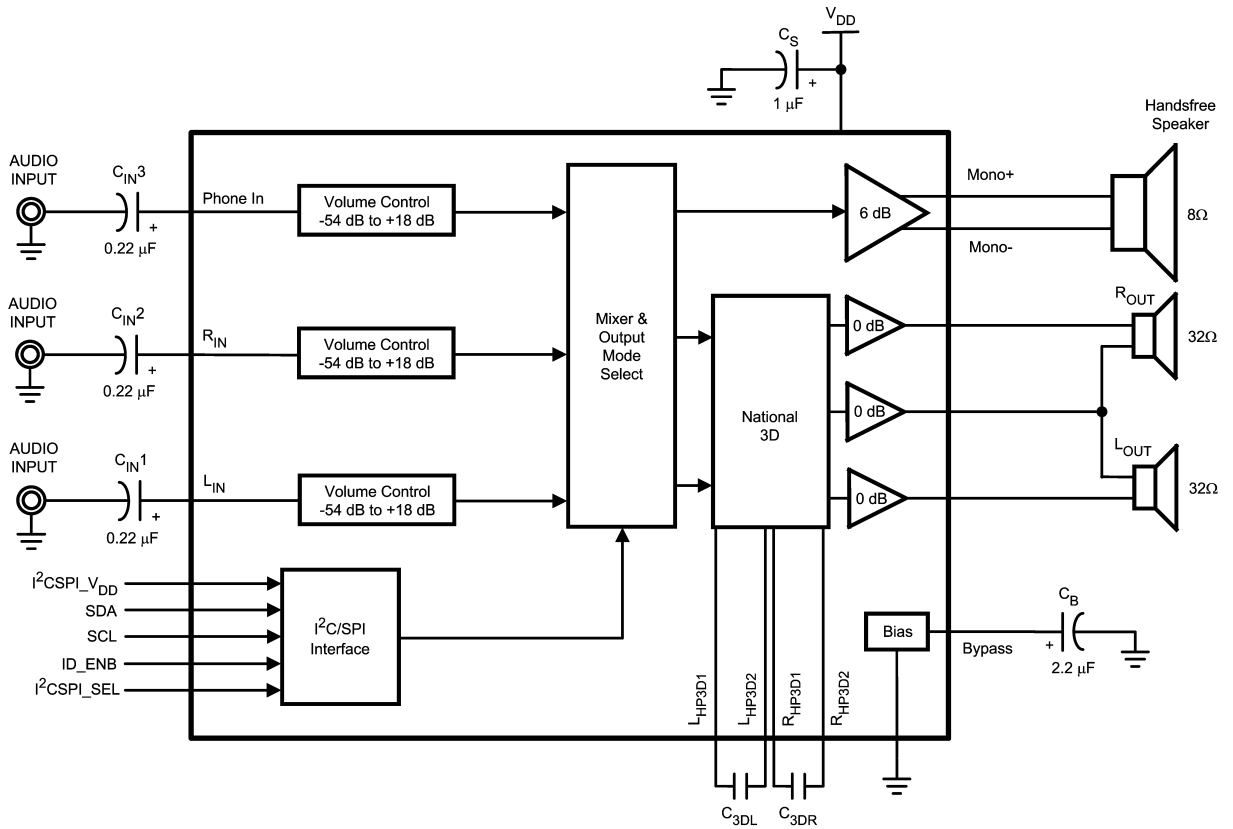

20166866

FIGURE 1. Typical Audio Amplifier Application Circuit-Output Capacitor-less

Typical Application (Continued)

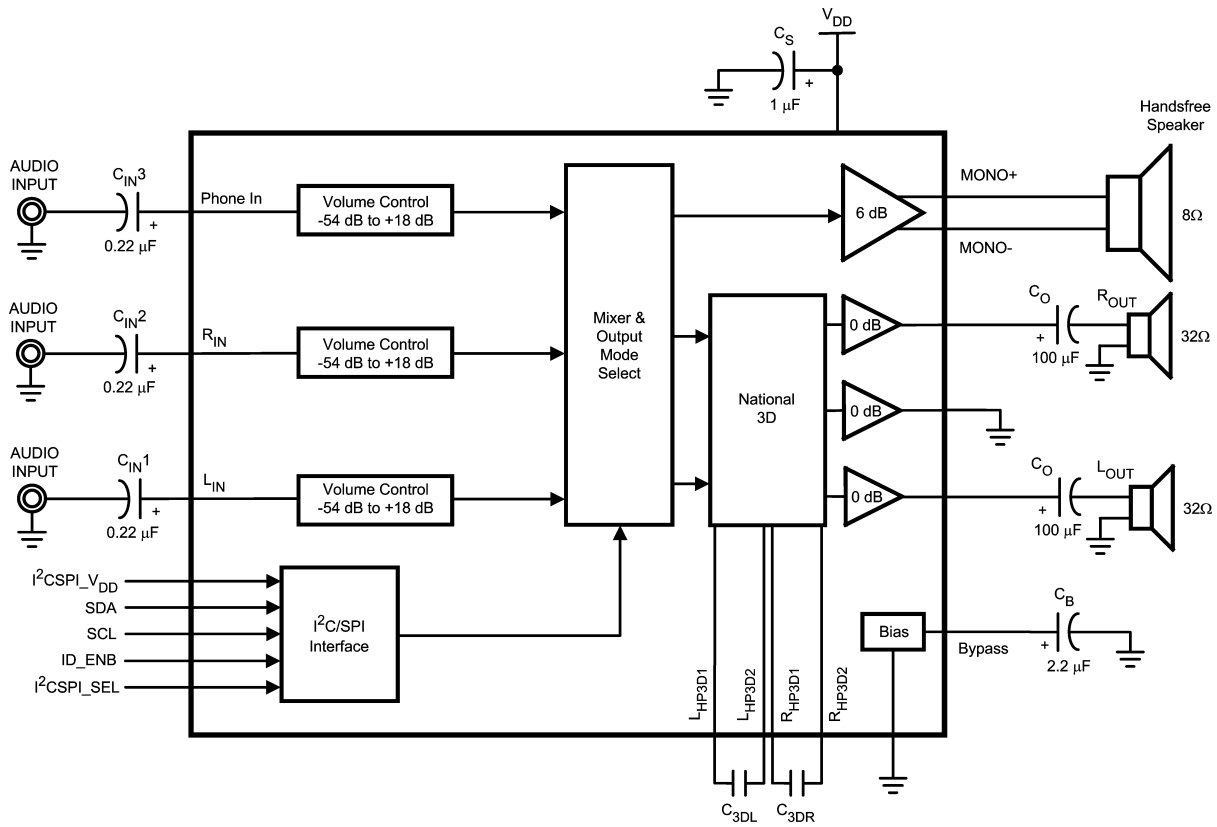

20166867

FIGURE 2. Typical Audio Amplifier Application Circuit-Single Ended

Connection Diagrams

25-Bump micro SMD

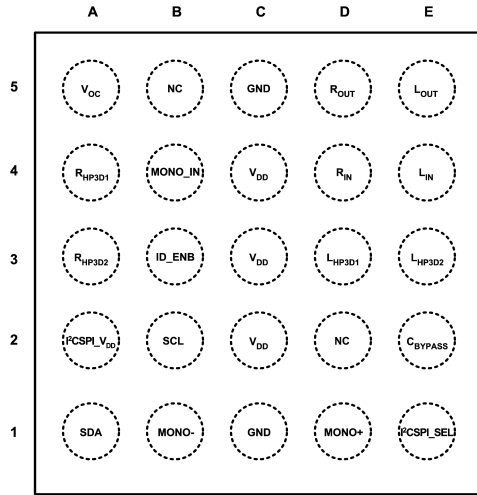

Top View

201668K1

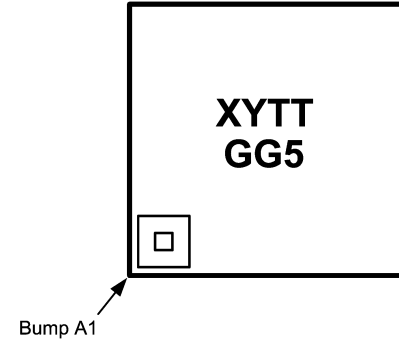

201668K0

Top View
 XY - Date Code
 TT - Die Traceability
 G - Boomer Family
 G5 - LM4846TL

Pin Descriptions

	Bump	Name	Description
1	A1	SDA	I ² C or SPI Data
2	A2	I ² CSP _L V _{DD}	I ² C or SPI Interface Power Supply
3	A3	R _{HP3D2}	Right Headphone 3D Input 2
4	A4	R _{HP3D1}	Right Headphone 3D Input 1
5	A5	V _{OC}	Center Amplifier Output
6	B1	MONO ₋	Loudspeaker Negative Output
7	B2	SCL	I ² C or SPI Clock
8	B3	ID_ENB	Address Identification/Enable Bar
9	B4	Phone_In	Mono Input
10	B5	NC	No Connect
11	C1	GND	Ground
12	C2	V _{DD}	Power Supply
13	C3	V _{DD}	Power Supply
14	C4	V _{DD}	Power Supply
15	C5	GND	GND
16	D1	MONO ₊	Loudspeaker Positive Output
17	D2	NC	No Connect
18	D3	L _{HP3D1}	Left Headphone 3D Input 1
19	D4	R _{IN}	Right Input Channel
20	D5	R _{OUT}	Right Headphone Output
21	E1	I ² C SPI_SEL	I ² C or SPI Select
22	E2	C _{BYPASS}	Half-Supply Bypass
23	E3	L _{HP3D2}	Left Headphone 3D Input 2
24	E4	L _{IN}	Left Input Channel
25	E5	L _{OUT}	Left Headphone Output

Absolute Maximum Ratings (Note 2)

If Military/Aerospace specified devices are required, please contact the National Semiconductor Sales Office/Distributors for availability and specifications.

Supply Voltage	6.0V
Storage Temperature	-65°C to +150°C
Input Voltage	-0.3 to $V_{DD} + 0.3$
ESD Susceptibility (Note 3)	2.0kV
ESD Machine model (Note 6)	200V
Junction Temperature (T_J)	150°C
Solder Information (Note 1)	

Vapor Phase (60 sec.)	215°C
Infrared (15 sec.)	220°C
Thermal Resistance	
θ_{JA} (typ) - TLA25CBA	65°C/W (Note 8)

Operating Ratings (Note 2)

Temperature Range	-40°C to 85°C
Supply Voltage (V_{DD})	$2.7V \leq V_{DD} \leq 5.5V$
Supply Voltage (I^2C/SPI)	$2.2V \leq V_{DD} \leq 5.5V$

Electrical Characteristics 3.3V (Notes 2, 7)

The following specifications apply for $V_{DD} = 3.3V$, $T_A = 25^\circ C$ unless otherwise specified. [$A_V = 2$ (BTL), $A_V = 1$ (SE)]

Symbol	Parameter	Conditions	LM4846		Units (Limits)	
			Typical (Note 4)	Limits (Note 5)		
I_{DD}	Supply Current	Output Modes 2, 4, 6 $V_{IN} = 0V$; No load, OCL = 0 (Table 2)	3.3	6.5	mA (max)	
		Output Modes 1, 3, 5, 7 $V_{IN} = 0V$; No load, BTL, OCL = 0 (Table 2)	6	11	mA (max)	
I_{SD}	Shutdown Current	Output Mode 0	0.1	1	μA (max)	
V_{OS}	Output Offset Voltage	$V_{IN} = 0V$, Mode 5 (Note 10)	10	50	mV (max)	
P_O	Output Power	MONO _{OUT} ; $R_L = 8\Omega$ THD+N = 1%; $f = 1kHz$, BTL, Mode 1	500	400	mW (min)	
		R_{OUT} and L_{OUT} ; $R_L = 32\Omega$ THD+N = 1%; $f = 1kHz$, SE, Mode 4	42	20	mW (min)	
THD+N	Total Harmonic Distortion Plus Noise	MONO _{OUT} $f = 20Hz$ to $20kHz$ $P_{OUT} = 250mW$; $R_L = 8\Omega$, BTL, Mode 1	0.5		%	
		R_{OUT} and L_{OUT} $f = 20Hz$ to $20kHz$ $P_{OUT} = 12mW$; $R_L = 32\Omega$, SE, Mode 4	0.5		%	
N_{OUT}	Output Noise	A-weighted (Note 9), Mode 5, BTL input referred	26		μV	
PSRR	Power Supply Rejection Ratio MONO _{OUT}	$V_{RIPPLE} = 200mV_{PP}$; $f = 217Hz$, $C_B = 2.2\mu F$, BTL All audio inputs terminated into 50Ω ; output referred gain = 6dB (BTL)				
		Output Mode 1,7	71		dB	
		Output Mode 3	68		dB	
		Output Mode 5	63		dB	
	Power Supply Rejection Ratio R_{OUT} and L_{OUT}	$V_{RIPPLE} = 200mV_{PP}$; $f = 217Hz$ $C_B = 2.2\mu F$, SE, $C_O = 100\mu F$ All audio inputs terminated into 50Ω ; output referred gain, OCL = 0 (Table 2)				
		Output Mode 2	88		dB	
		Output Mode 4	76		dB	
	Output Mode 6, 7	76		dB		

Electrical Characteristics 3.3V (Notes 2, 7) (Continued)The following specifications apply for $V_{DD} = 3.3V$, $T_A = 25^\circ C$ unless otherwise specified. [$A_V = 2$ (BTL), $A_V = 1$ (SE)]

Symbol	Parameter	Conditions	LM4846		Units (Limits)
			Typical (Note 4)	Limits (Note 5)	
	Digital Volume Range (R_{IN} and L_{IN})	Input referred maximum attenuation	-54	-53.25 -54.75	dB (min) dB (max)
		Input referred maximum gain	18	17.25 18.75	dB (min) dB (max)
	Mute Attenuation	Output Mode 1, 3, 5	80		dB
	MONO_IN Input Impedance R_{IN} and L_{IN} Input Impedance	Maximum gain setting	11	8 14	k Ω (min) k Ω (max)
Maximum attenuation setting		100	75 125	k Ω (min) k Ω (max)	
T_{WU}	Wake-Up Time from Shutdown	$C_B = 2.2\mu F$, OCL	90		ms
		$C_B = 2.2\mu F$, SE	138		

Electrical Characteristics 5.0V (Notes 3, 7)The following specifications apply for $V_{DD} = 5.0V$, $T_A = 25^\circ C$ unless otherwise specified. [$A_V = 2$ (BTL), $A_V = 1$ (SE)].

Symbol	Parameter	Conditions	LM4846		Units (Limits)	
			Typical (Note 4)	Limits (Notes 5, 10)		
I_{DD}	Supply Current	Output Modes 2, 4, 6 $V_{IN} = 0V$; No load, OCL = 0 (Table 2)	3.6		mA	
		Output Modes 1, 3, 5, 7 $V_{IN} = 0V$; No Load, OCL = 0 (Table 2)	6.8		mA	
I_{SD}	Shutdown Current	Output Mode 0	0.1		μA	
V_{OS}	Output Offset Voltage	$V_{IN} = 0V$, Mode 5 (Note 10)	10		mV	
P_O	Output Power	MONO _{OUT} ; $R_L = 8\Omega$ THD+N = 1%; $f = 1kHz$, BTL, Mode 1	1.15		W	
		R_{OUT} and L_{OUT} ; $R_L = 32\Omega$ THD+N = 1%; $f = 1kHz$, SE, Mode 4	75		mW	
THD+N	Total Harmonic Distortion Plus Noise	MONO _{OUT} $f = 20Hz$ to $20kHz$ $P_{OUT} = 500mW$; $R_L = 8\Omega$, BTL, Mode 1	0.5		%	
		R_{OUT} and L_{OUT} $f = 20Hz$ to $20kHz$ $P_{OUT} = 30mW$; $R_L = 32\Omega$, SE, Mode 4	0.5		%	
N_{OUT}	Output Noise	A-weighted (Note 9), Mode 5, BTL input referred	26		μV	
PSRR	Power Supply Rejection Ratio MONO _{OUT}	$V_{RIPPLE} = 200mV_{PP}$; $f = 217Hz$, $C_B = 2.2\mu F$, BTL All audio inputs terminated into 50Ω ; output referred gain = 6dB (BTL)				
		Output Mode 1, 7	71		dB	
		Output Mode 3	68		dB	
		Output Mode 5	63		dB	
	Power Supply Rejection Ratio R_{OUT} and L_{OUT}	$V_{RIPPLE} = 200mV_{PP}$; $f = 217Hz$, $C_B = 2.2\mu F$, SE, $C_O = 100\mu F$ All audio inputs terminated into 50Ω ; output referred gain, OCL = 0 (Table 2)				
		Output Mode 2	88		dB	
		Output Mode 4	76		dB	
Output Mode 6, 7	76		dB			
Digital Volume Range (R_{IN} and L_{IN})	Input referred maximum attenuation		-54	-53.25 -54.75	dB dB	
		Input referred maximum gain	18	17.25 18.75	dB dB	
	Mute Attenuation	Output Mode 1, 3, 5	80		dB	
	MONO_IN Input Impedance R_{IN} and L_{IN} Input Impedance	Maximum gain setting	11		k Ω k Ω	
		Minimum gain setting	100		k Ω k Ω	
T_{WU}	Wake-Up Time from Shutdown	$C_B = 2.2\mu F$, OCL	122		ms	
		$C_B = 2.2\mu F$, SE	184			

I²C/SPI (Notes 2, 7)

The following specifications apply for $V_{DD} = 5.0V$ and $3.3V$, $T_A = 25^\circ C$ unless otherwise specified.

Symbol	Parameter	Conditions	LM4846		Units (Limits)
			Typical (Note 4)	Limits (Notes 5, 10)	
t_1	I ² C Clock Period			2.5	μs (max)
t_2	I ² C Clock Setup Time			100	ns (min)
t_3	I ² C Data Hold Time			100	ns (min)
t_4	Start Condition Time			100	ns (min)
t_5	Stop Condition Time			100	ns (min)
f_{SPI}	Maximum SPI Frequency			1000	kHz (max)
t_{EL}	SPI ENB Low Time			100	ns (min)
t_{DS}	SPI Data Setup Time			100	μs (max)
t_{ES}	SPI ENB Setup Time			100	ns (min)
t_{DH}	SPI Data Hold Time			100	ns (min)
t_{EH}	SPI Enable Hold Time			100	ns (min)
t_{CL}	SPI Clock Low Time			500	ns (min)
t_{CH}	SPI Clock High Time			500	ns (min)
t_{CS}	SPI Clock Transition Time			100	ns (min)
V_{IH}	I ² C/SPI Input Voltage High			$0.7 \times I^2CSPI$ V_{DD}	V (min)
V_{IL}	I ² C/SPI Input Voltage Low			$0.3 \times I^2CSPI$ V_{DD}	V (max)

Note 1: See AN-450 "Surface Mounting and their effects on Product Reliability" for other methods of soldering surface mount devices.

Note 2: Operating Ratings indicate conditions for which the device is functional, but do not guarantee specific performance limits. For guaranteed specifications and test conditions, see the Electrical Characteristics. The guaranteed specifications apply only for the test conditions listed. Some performance characteristics may degrade when the device is not operated under the listed test conditions.

Note 3: Human body model, 100pF discharged through a 1.5k Ω resistor.

Note 4: Typical specifications are specified at +25 $^\circ C$ and represent the most likely parametric norm.

Note 5: Tested limits are guaranteed to National's AOQL (Average Outgoing Quality Level).

Note 6: Machine Model ESD test is covered by specification EIAJ IC-121-1981. A 200pF cap is charged to the specified voltage, then discharged directly into the IC with no external series resistor (resistance of discharge path must be under 50 Ω).

Note 7: All voltages are measured with respect to the ground pin, unless otherwise specified.

Note 8: The given θ_{JA} for an LM4846ITL mounted on a demonstration board with a 9in² area of 1oz printed circuit board copper ground plane.

Note 9: Datasheet min/max specifications are guaranteed by design, test, or statistical analysis.

Note 10: Potentially worse case: All three input stages are DC coupled to the BTL output stage.

Typical Performance Characteristics

THD+N vs Frequency
 $V_{DD} = 3.3V$, $R_L = 8\Omega$, $P_O = 250mW$
 Mode 1, BTL

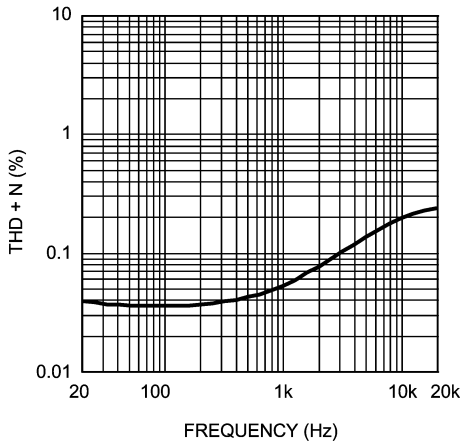

20166825

THD+N vs Frequency
 $V_{DD} = 3.3V$, $R_L = 32\Omega$, $P_O = 12mW$
 Mode 4, OCL

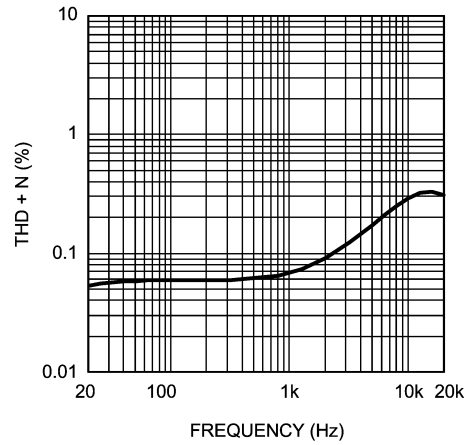

20166826

THD+N vs Frequency
 $V_{DD} = 3.3V$, $R_L = 32\Omega$, $P_O = 12mW$
 Mode 6, OCL

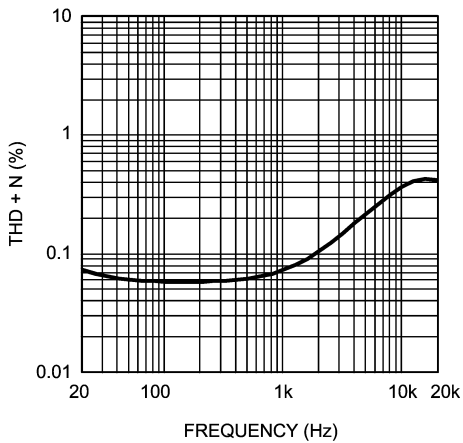

20166828

THD+N vs Frequency
 $V_{DD} = 3.3V$, $R_L = 32\Omega$, $P_O = 12mW$
 Mode 4, SE

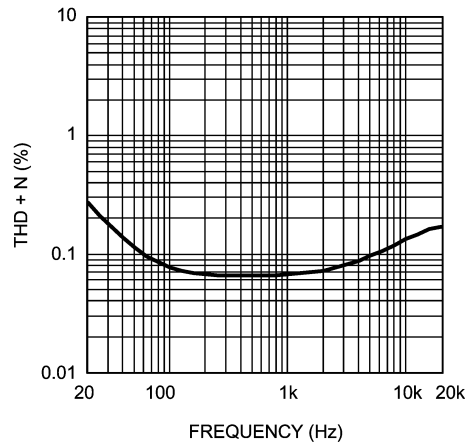

20166827

THD+N vs Frequency
 $V_{DD} = 3.3V$, $R_L = 32\Omega$, $P_O = 12mW$
 Mode 6, SE

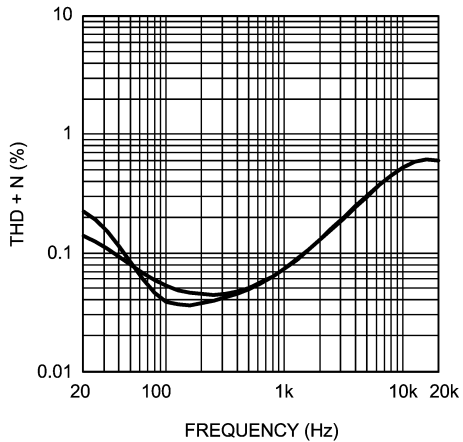

20166829

THD+N vs Frequency
 $V_{DD} = 3.3V$, $R_L = 8\Omega$, $P_O = 250mW$
 Mode 5

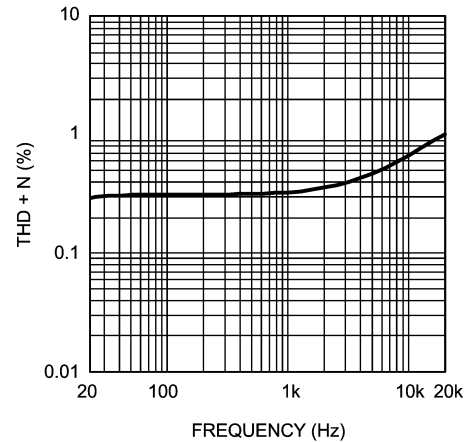

20166830

Typical Performance Characteristics (Continued)

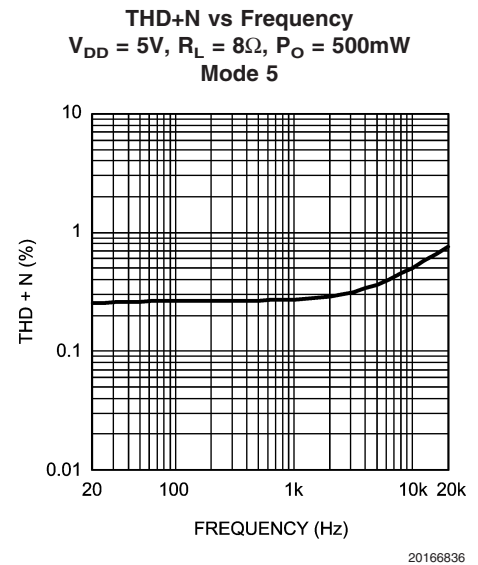
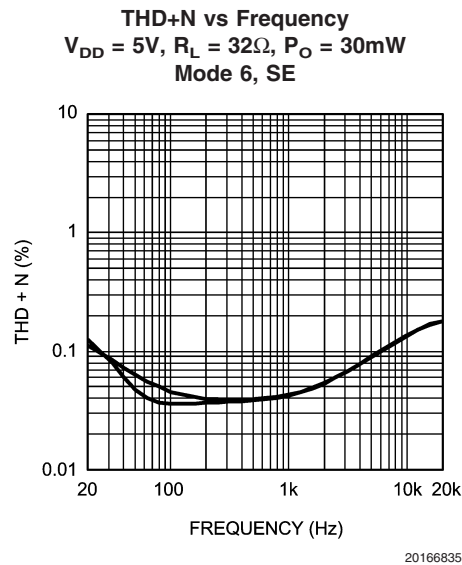
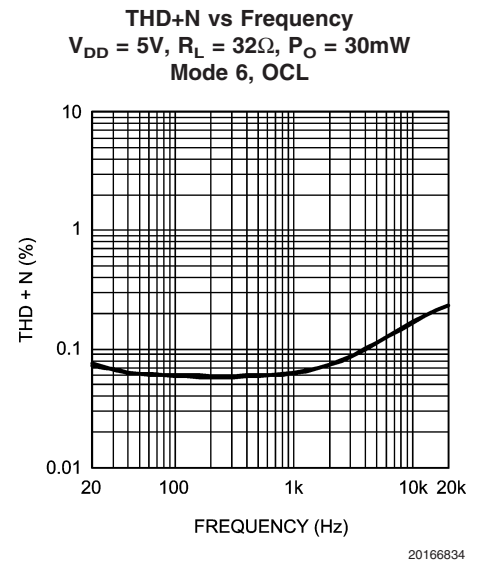
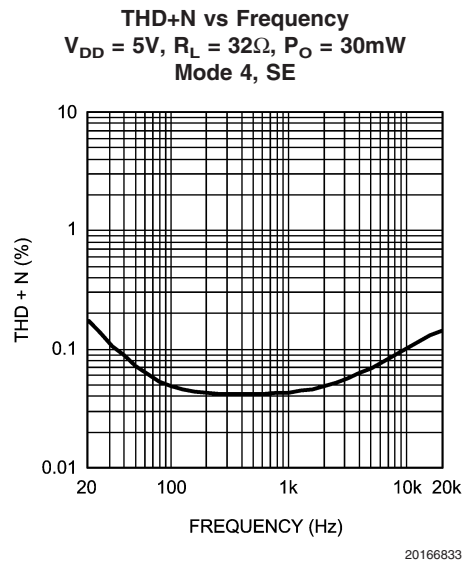
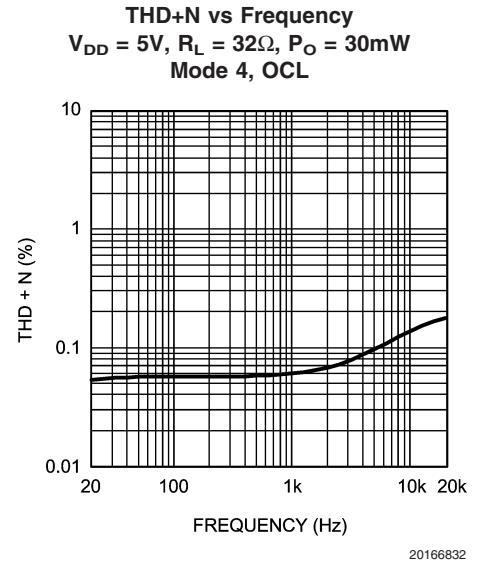
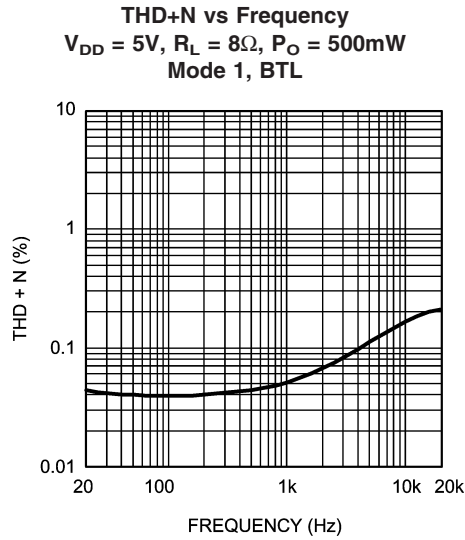

Typical Performance Characteristics (Continued)

THD+N vs Output Power
 $V_{DD} = 3.3V, R_L = 8\Omega, f = 1kHz$
 Mode 1, BTL

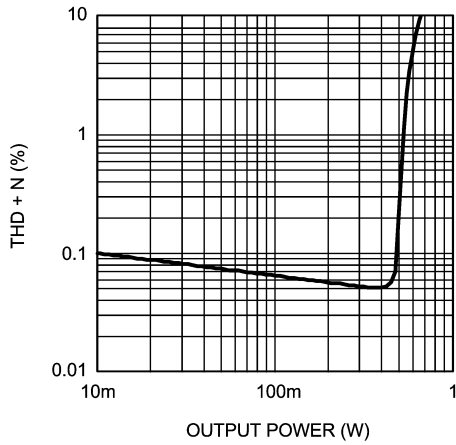

20166837

THD+N vs Output Power
 $V_{DD} = 3.3V, R_L = 8\Omega, f = 1kHz$
 Mode 5, BTL

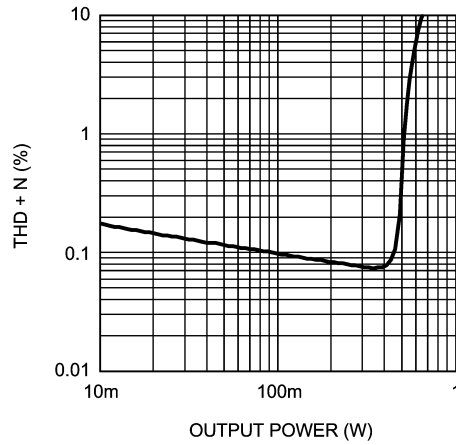

20166838

THD+N vs Output Power
 $V_{DD} = 3.3V, R_L = 32\Omega, f = 1kHz$
 Mode 4, OCL

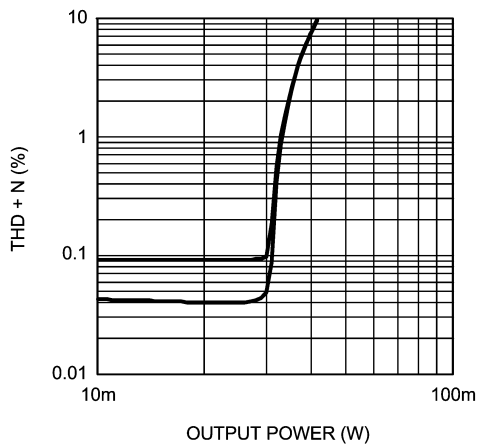

20166839

THD+N vs Output Power
 $V_{DD} = 3.3V, R_L = 32\Omega, f = 1kHz$
 Mode 4, SE

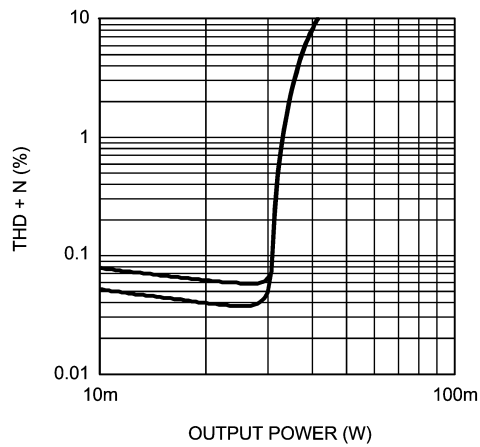

20166840

THD+N vs Output Power
 $V_{DD} = 3.3V, R_L = 32\Omega, f = 1kHz$
 Mode 6, OCL

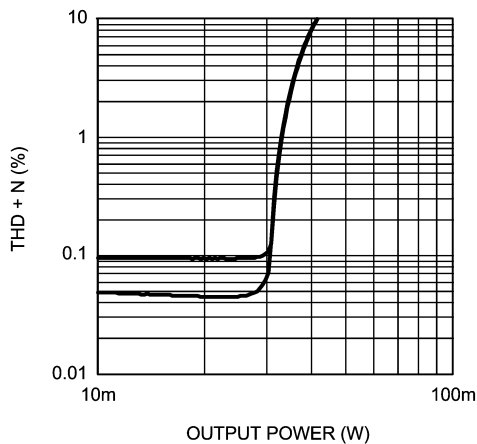

20166841

THD+N vs Output Power
 $V_{DD} = 3.3V, R_L = 32\Omega, f = 1kHz$
 Mode 6, SE

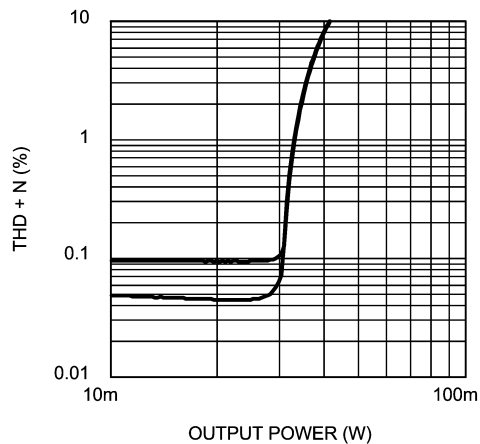

20166842

Typical Performance Characteristics (Continued)

THD+N vs Output Power
 $V_{DD} = 5V, R_L = 8\Omega, f = 1kHz$
 Mode 1, BTL

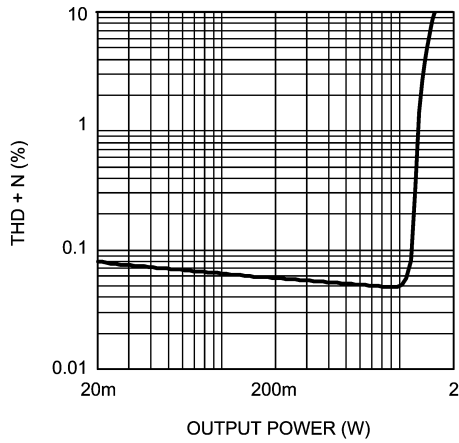

20166843

THD+N vs Output Power
 $V_{DD} = 5V, R_L = 8\Omega, f = 1kHz$
 Mode 5, BTL

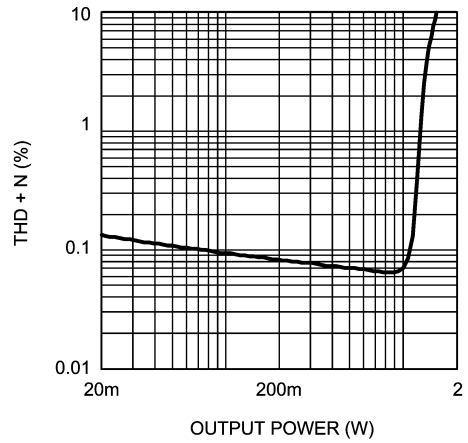

20166844

THD+N vs Output Power
 $V_{DD} = 5V, R_L = 32\Omega, f = 1kHz$
 Mode 4, OCL

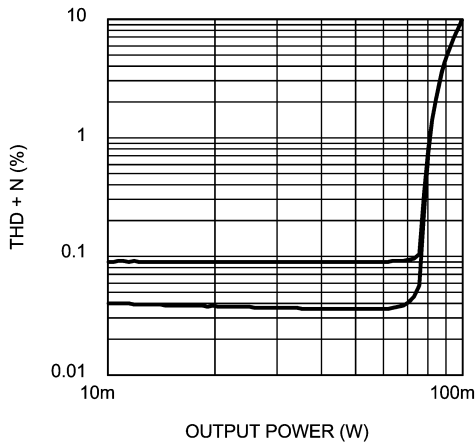

20166845

THD+N vs Output Power
 $V_{DD} = 5V, R_L = 32\Omega, f = 1kHz$
 Mode 4, SE

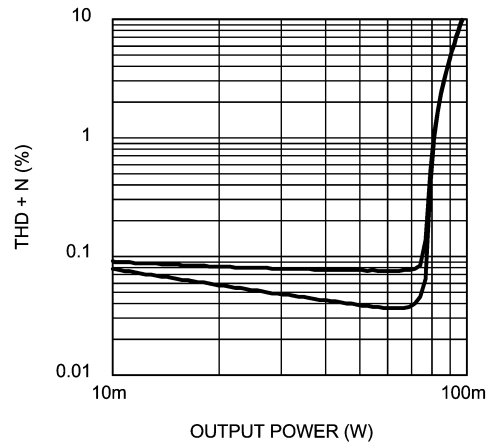

20166846

THD+N vs Output Power
 $V_{DD} = 5V, R_L = 32\Omega, f = 1kHz$
 Mode 6, OCL

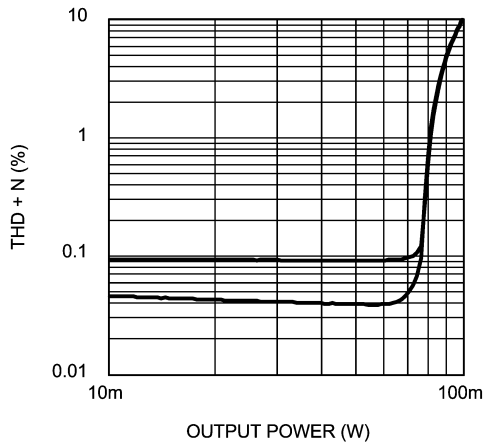

20166847

THD+N vs Output Power
 $V_{DD} = 5V, R_L = 32\Omega, f = 1kHz$
 Mode 6, SE

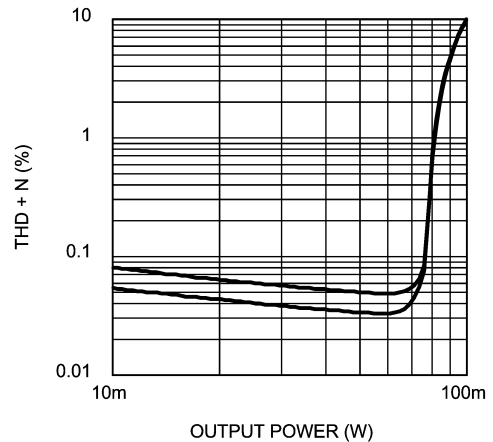

20166848

Typical Performance Characteristics (Continued)

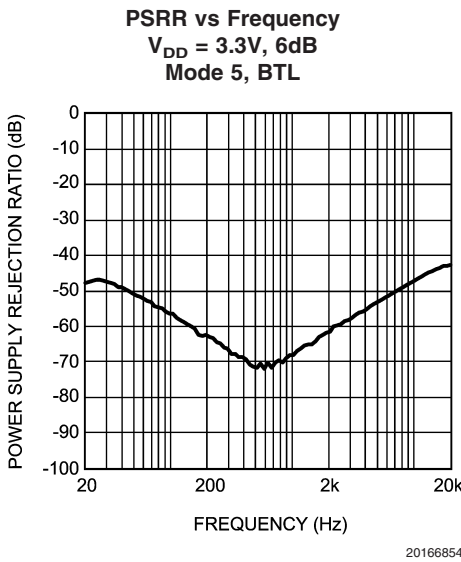
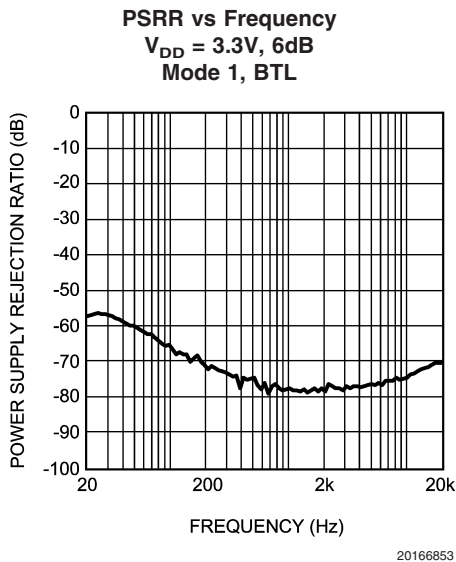
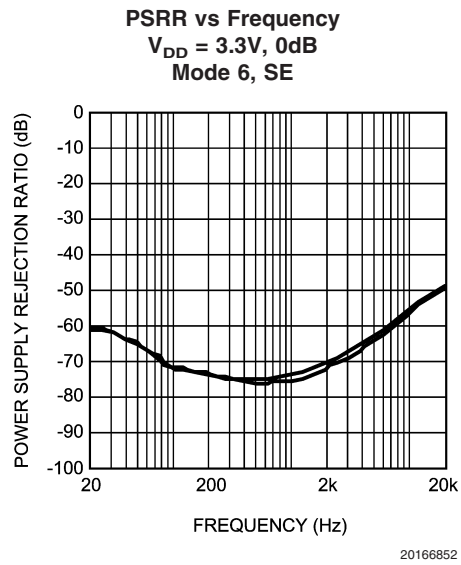
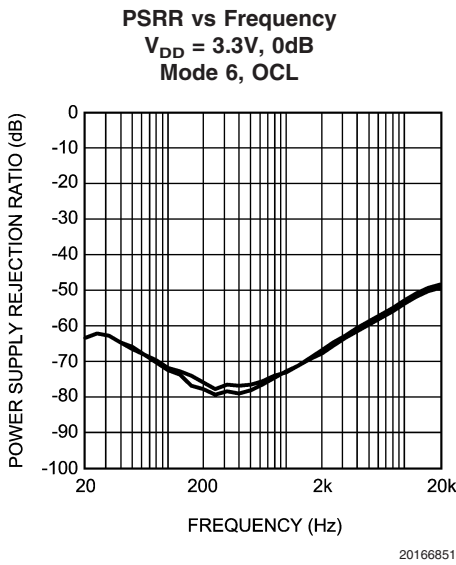
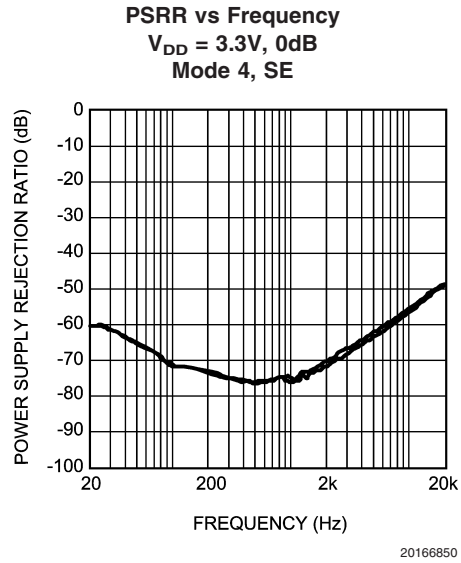
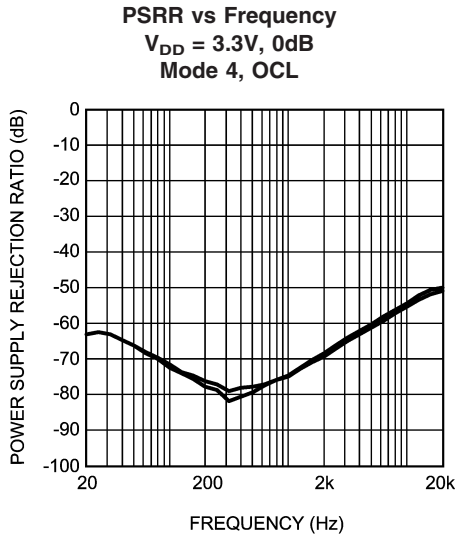

Typical Performance Characteristics (Continued)

Noise
 $V_{DD} = 3.3V$, Mode 4, OCL

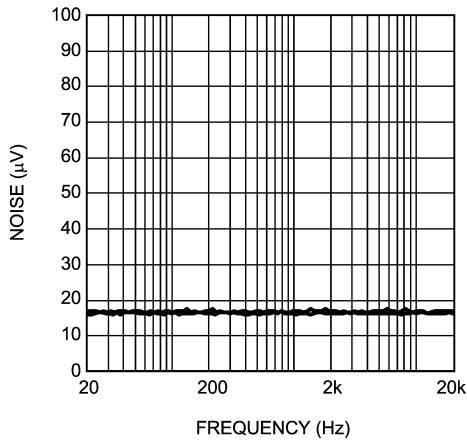

20166855

Noise
 $V_{DD} = 3.3V$, Mode 4, SE

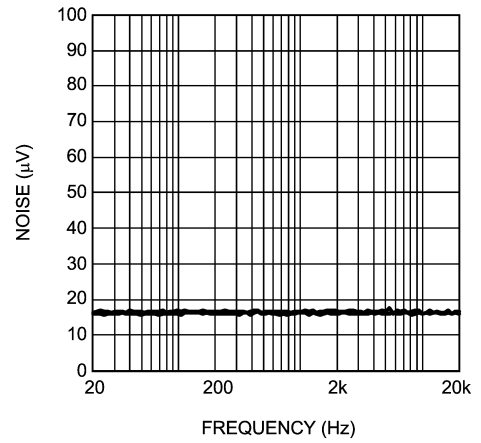

20166856

Noise
 $V_{DD} = 3.3V$, Mode 6, SE

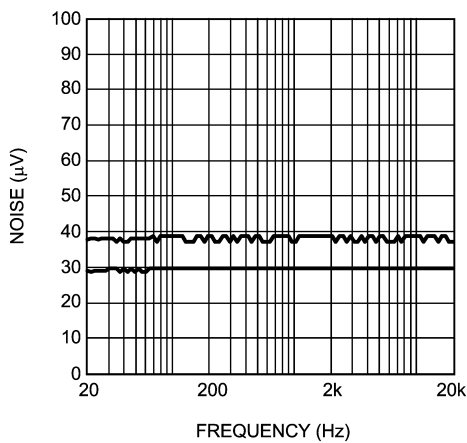

20166857

Noise
 $V_{DD} = 3.3V$, Mode 5, BTL

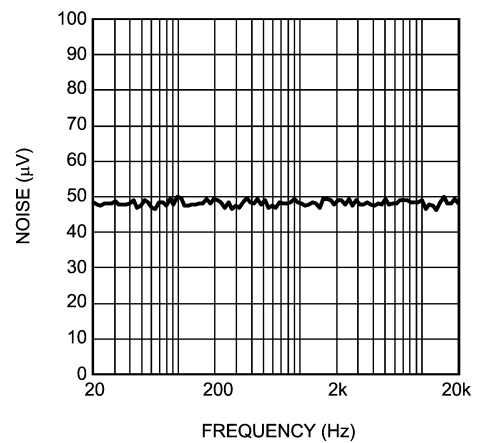

20166858

Noise
 $V_{DD} = 3.3V$, Mode 1, BTL

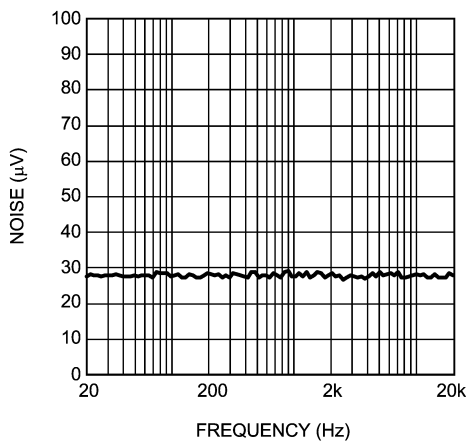

20166859

Power Dissipation vs Output Power
 $V_{DD} = 3.3V$, $R_L = 8\Omega$
 $f = 1kHz$, Mode 1, BTL

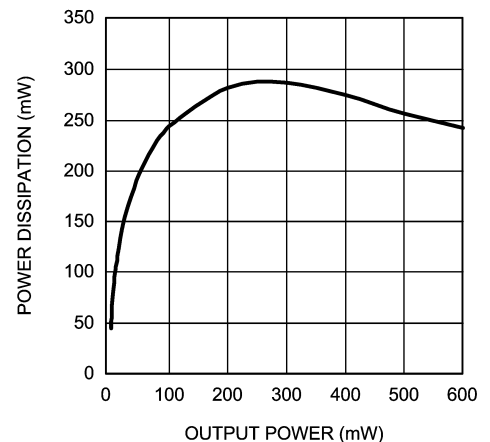

20166860

Typical Performance Characteristics (Continued)

Power Dissipation vs Output Power

$V_{DD} = 3.3V, R_L = 8\Omega$
 $f = 1kHz, BTL, Mode 5$

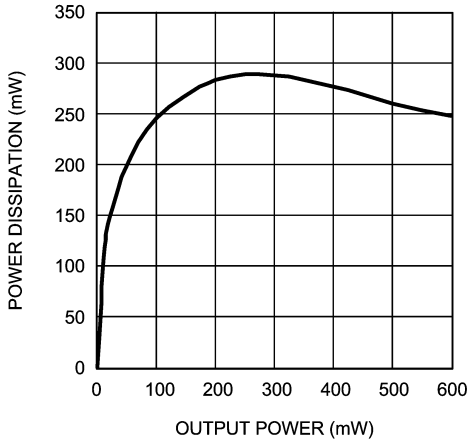

20166861

Power Dissipation vs Output Power

$V_{DD} = 3.3V, R_L = 32\Omega$
 $f = 1kHz, OCL, Mode 4$

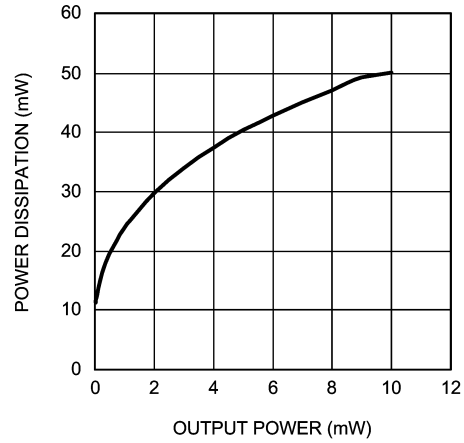

20166862

Power Dissipation vs Output Power

$V_{DD} = 3.3V, R_L = 32\Omega$
 $f = 1kHz, OCL, Mode 6$

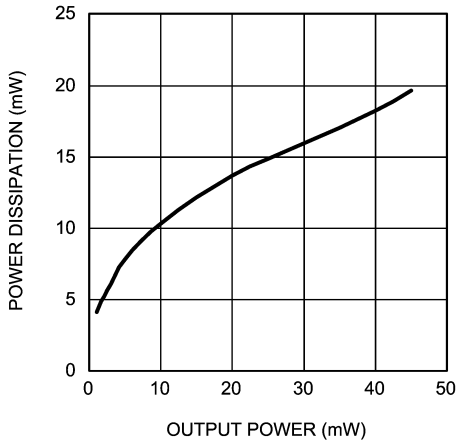

20166863

Power Dissipation vs Output Power

$V_{DD} = 3.3V, R_L = 32\Omega$
 $f = 1kHz, SE, Mode 4$

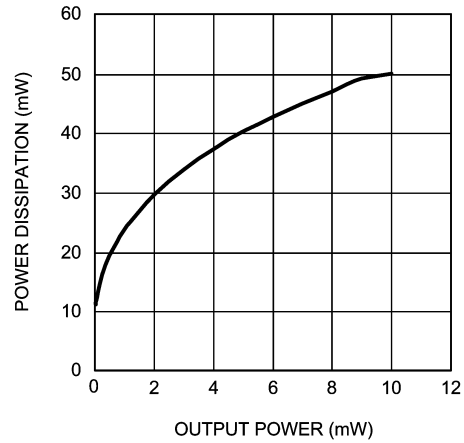

20166864

Power Dissipation vs Output Power

$V_{DD} = 3.3V, R_L = 32\Omega$
 $f = 1kHz, SE, Mode 6$

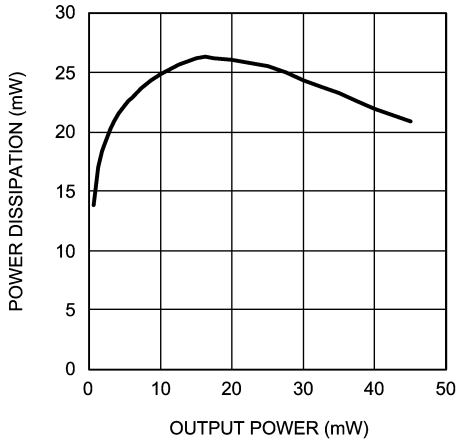

20166865

Power Dissipation vs Output Power

$V_{DD} = 5V, R_L = 8\Omega$
 $f = 1kHz, BTL, Mode 1$

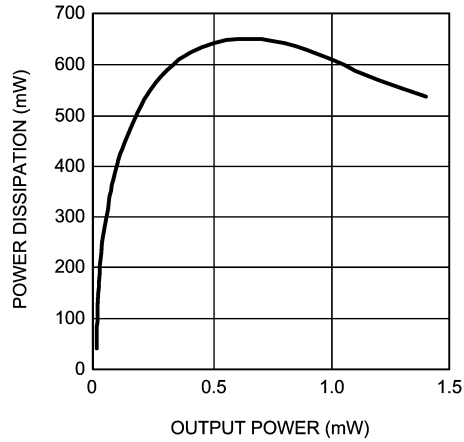

20166868

Typical Performance Characteristics (Continued)

Power Dissipation vs Output Power

$V_{DD} = 5V, R_L = 8\Omega$
 $f = 1kHz, BTL, Mode 5$

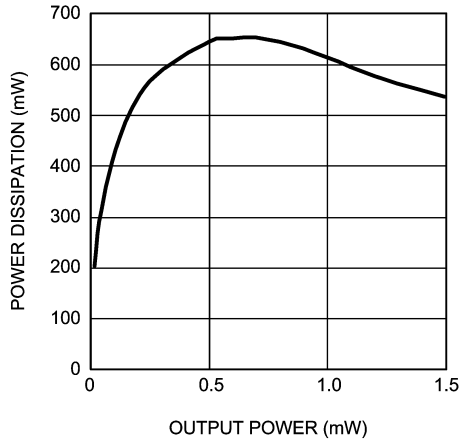

20166869

Power Dissipation vs Output Power

$V_{DD} = 5V, R_L = 32\Omega$
 $f = 1kHz, OCL, Mode 4$

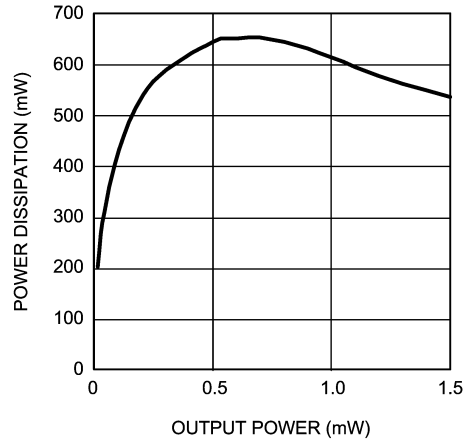

20166870

Power Dissipation vs Output Power

$V_{DD} = 5V, R_L = 32\Omega$
 $f = 1kHz, OCL, Mode 6$

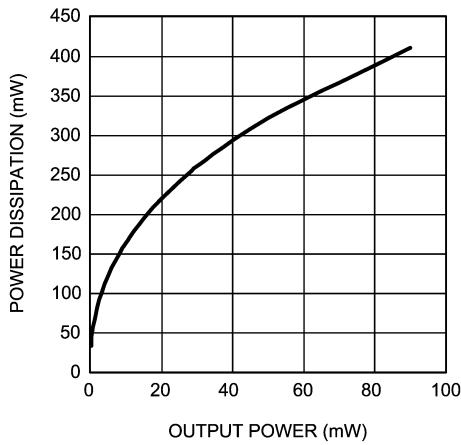

20166871

Power Dissipation vs Output Power

$V_{DD} = 5V, R_L = 32\Omega$
 $f = 1kHz, SE, Mode 4$

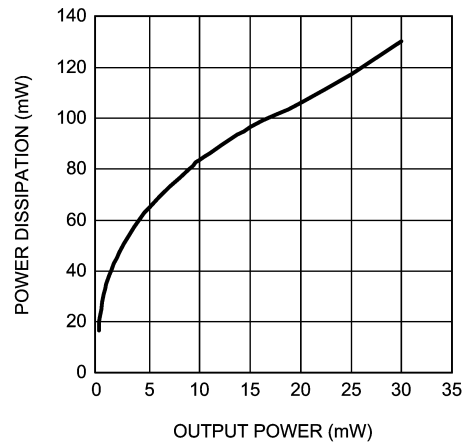

20166872

Power Dissipation vs Output Power

$V_{DD} = 5V, R_L = 32\Omega$
 $f = 1kHz, SE, Mode 6$

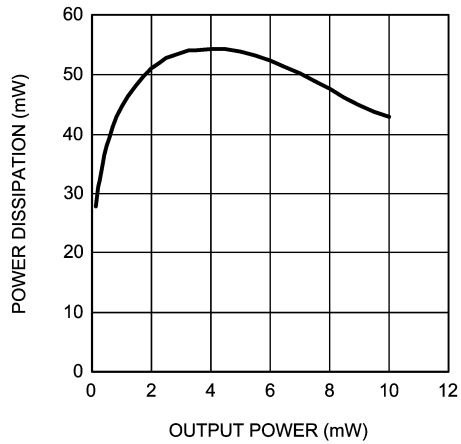

20166873

Crosstalk vs Frequency

$V_{DD} = 3.3V, R_L = 32\Omega, P_O = 12mW$
 Right-Left, OCL, Mode 4

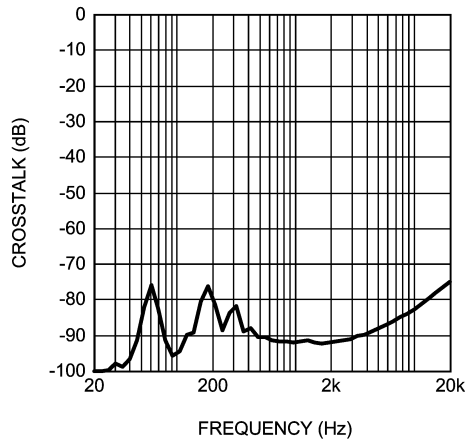

20166874

Typical Performance Characteristics (Continued)

Crosstalk vs Frequency
 $V_{DD} = 3.3V$, $R_L = 32\Omega$, $P_O = 12mW$
 Right-Left, OCL, Mode 6

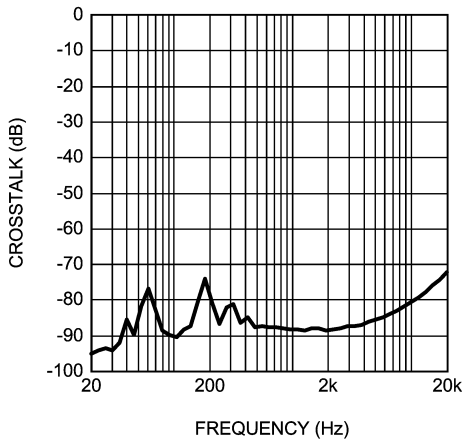

20166875

Crosstalk vs Frequency
 $V_{DD} = 3.3V$, $R_L = 32\Omega$, $P_O = 12mW$
 Right-Left, SE, Mode 4

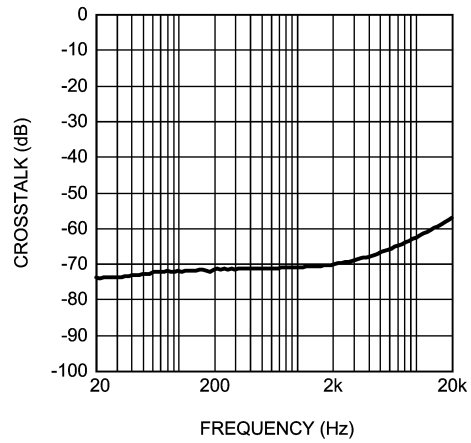

20166876

Crosstalk vs Frequency
 $V_{DD} = 3.3V$, $R_L = 32\Omega$, $P_O = 12mW$
 Right-Left, SE, Mode 6

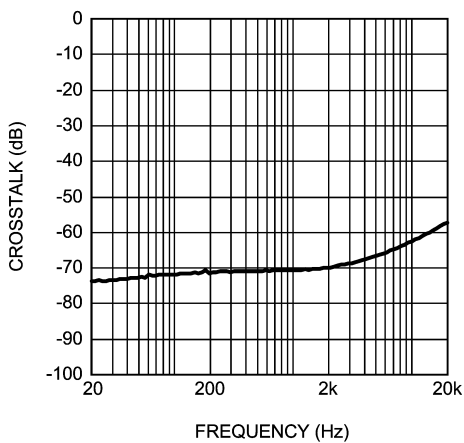

20166877

Supply Current vs Supply Voltage
 $R_L = 8\Omega$, Mode 1

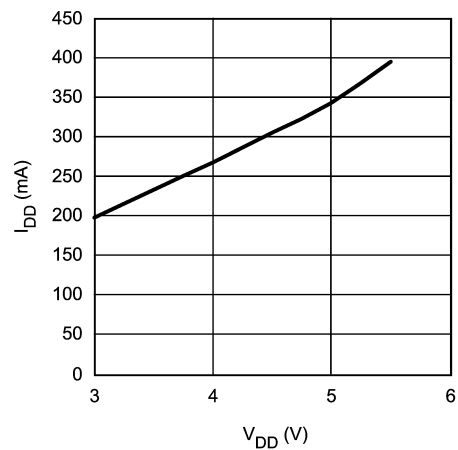

20166878

Supply Current vs Supply Voltage
 $R_L = 8\Omega$, Mode 5

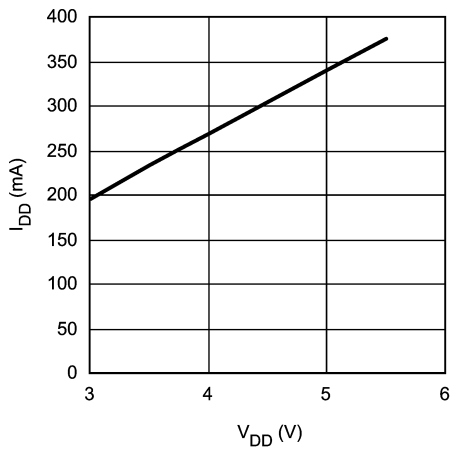

20166879

Supply Current vs Supply Voltage
 $R_L = 32\Omega$, OCL, Mode 4

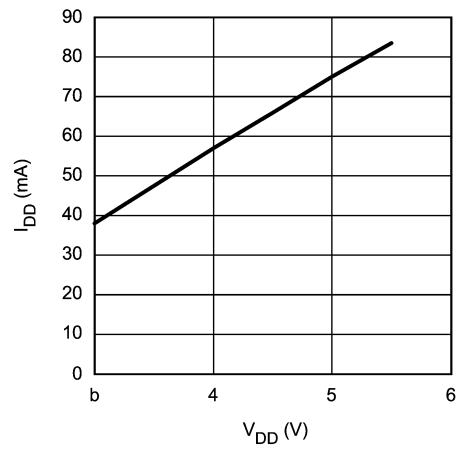

20166880

Typical Performance Characteristics (Continued)

Supply Current vs Supply Voltage
 $R_L = 32\Omega$, OCL, Mode 6

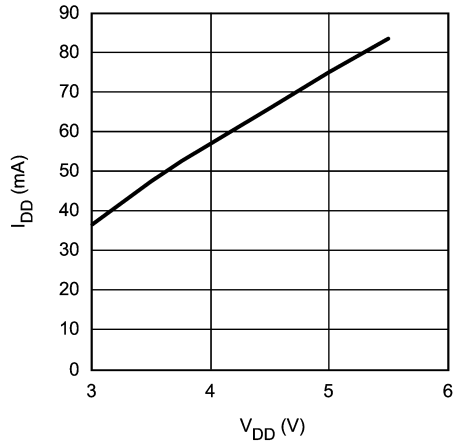

20166881

Supply Current vs Supply Voltage
 $R_L = 32\Omega$, SE, Mode 4

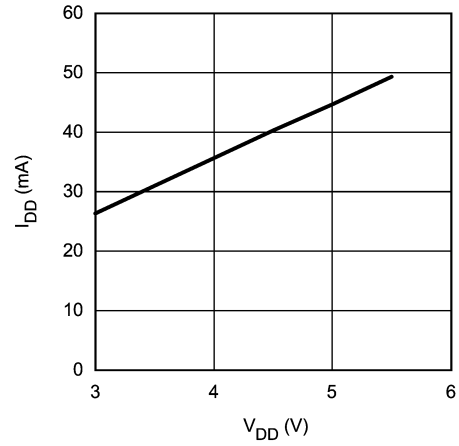

20166882

Supply Current vs Supply Voltage
 $R_L = 32\Omega$, SE, Mode 6

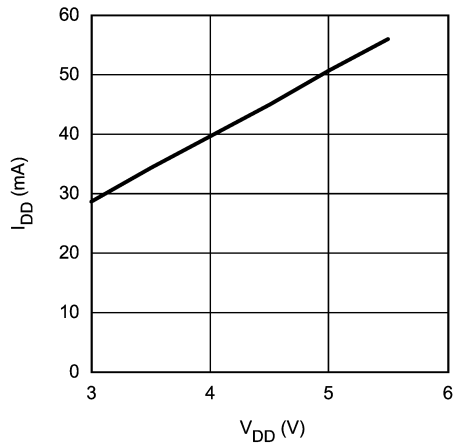

20166883

Output Power vs Supply Voltage
 $R_L = 8\Omega$, Mode 1

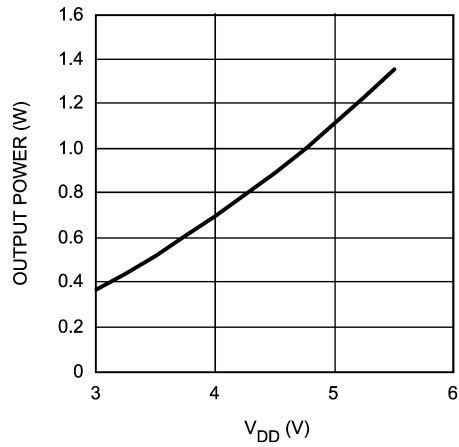

20166884

Output Power vs Supply Voltage
 $R_L = 8\Omega$, Mode 5

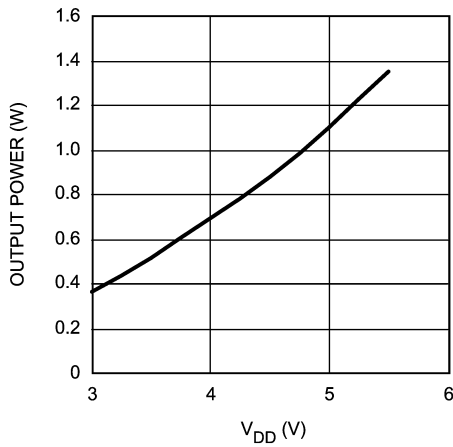

20166885

Output Power vs Supply Voltage
 $R_L = 32\Omega$, Mode 4

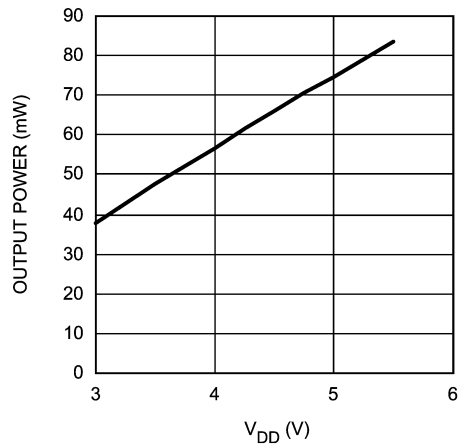

20166886

Typical Performance Characteristics (Continued)

Output Power vs Supply Voltage
 $R_L = 32\Omega$, OCL, Mode 6

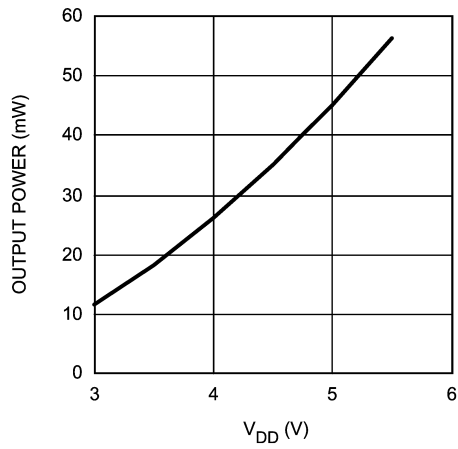

20166887

Output Power vs Supply Voltage
 $R_L = 32\Omega$, SE, Mode 4

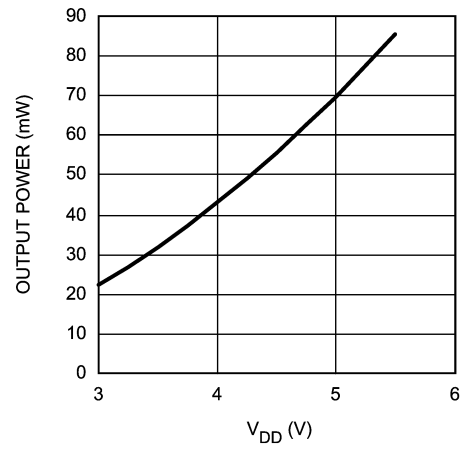

20166888

Output Power vs Supply Voltage
 $R_L = 32\Omega$, SE, Mode 6

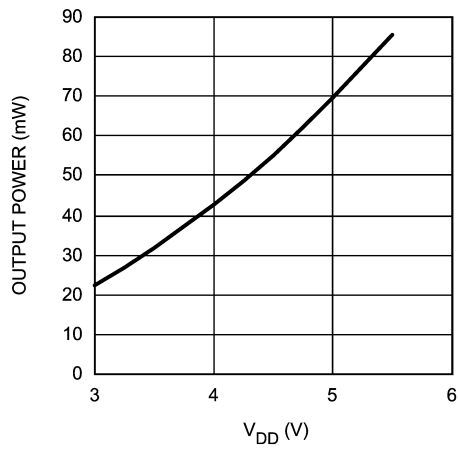

20166889

Application Information

I²C PIN DESCRIPTION

SDA: This is the serial data input pin.

SCL: This is the clock input pin.

ID_ENB: This is the address select input pin.

I²CSPI_SEL: This is tied LOW for I²C mode.

I²C COMPATIBLE INTERFACE

The LM4846 uses a serial bus which conforms to the I²C protocol to control the chip's functions with two wires: clock (SCL) and data (SDA). The clock line is uni-directional. The data line is bi-directional (open-collector). The maximum clock frequency specified by the I²C standard is 400kHz. In this discussion, the master is the controlling microcontroller and the slave is the LM4846.

The I²C address for the LM4846 is determined using the ID_ENB pin. The LM4846's two possible I²C chip addresses are of the form 111110X₁0 (binary), where X₁ = 0, if ID_ENB is logic LOW; and X₁ = 1, if ID_ENB is logic HIGH. If the I²C interface is used to address a number of chips in a system, the LM4846's chip address can be changed to avoid any possible address conflicts.

The bus format for the I²C interface is shown in Figure 3. The bus format diagram is broken up into six major sections:

The "start" signal is generated by lowering the data signal while the clock signal is HIGH. The start signal will alert all devices attached to the I²C bus to check the incoming address against their own address.

The 8-bit chip address is sent next, most significant bit first. The data is latched in on the rising edge of the clock. Each address bit must be stable while the clock level is HIGH.

For I²C interface operation, the I²CSPI_SEL pin needs to be tied LOW (and tied high for SPI operation).

After the last bit of the address bit is sent, the master releases the data line HIGH (through a pull-up resistor). Then the master sends an acknowledge clock pulse. If the LM4846 has received the address correctly, then it holds the data line LOW during the clock pulse. If the data line is not held LOW during the acknowledge clock pulse, then the master should abort the rest of the data transfer to the LM4846.

The 8 bits of data are sent next, most significant bit first. Each data bit should be valid while the clock level is stable HIGH.

After the data byte is sent, the master must check for another acknowledge to see if the LM4846 received the data.

If the master has more data bytes to send to the LM4846, then the master can repeat the previous two steps until all data bytes have been sent.

The "stop" signal ends the transfer. To signal "stop", the data signal goes HIGH while the clock signal is HIGH. The data line should be held HIGH when not in use.

I²C INTERFACE POWER SUPPLY PIN (I²CV_{DD})

The LM4846's I²C interface is powered up through the I²CV_{DD} pin. The LM4846's I²C interface operates at a voltage level set by the I²CV_{DD} pin which can be set independent to that of the main power supply pin V_{DD}. This is ideal whenever logic levels for the I²C interface are dictated by a microcontroller or microprocessor that is operating at a lower supply voltage than the main battery of a portable system.

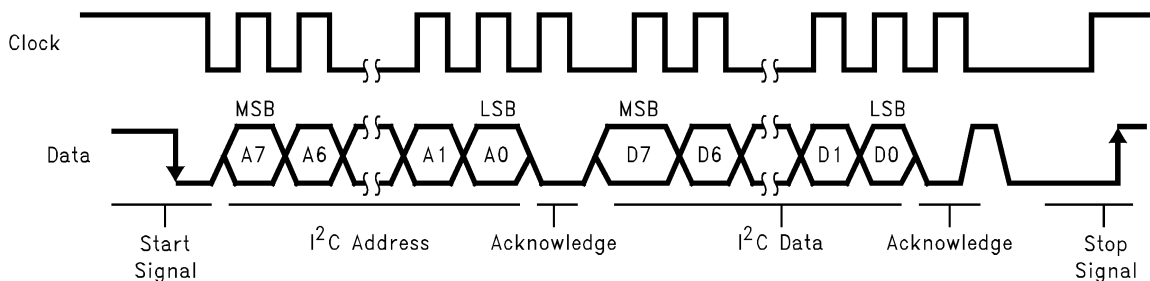

201668F5

FIGURE 3. I²C Bus Format

Application Information (Continued)

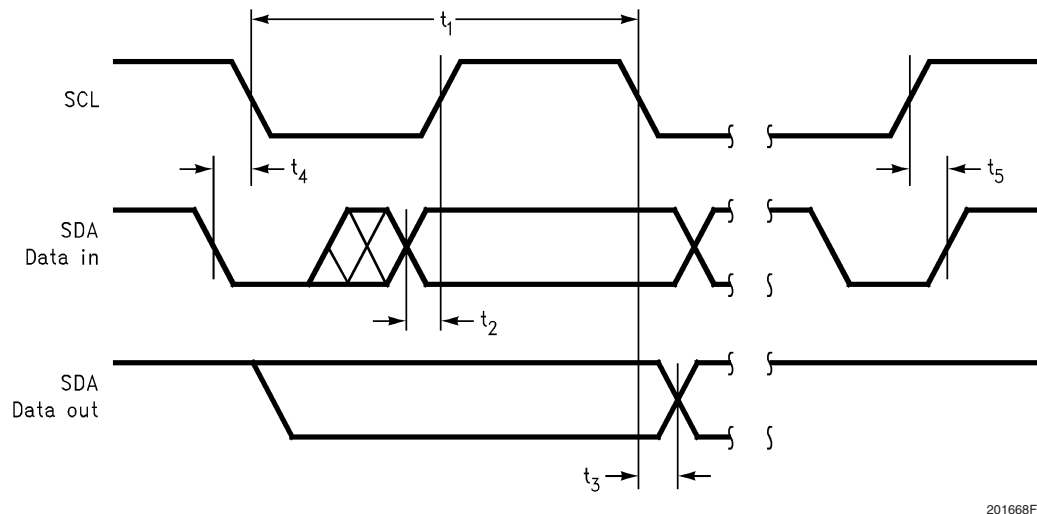

FIGURE 4. I²C Timing Diagram

SPI DESCRIPTION

0. I²CSPi_SEL: This pin is tied HIGH for SPI mode.

1. The data bits are transmitted with the MSB first.

2. The maximum clock rate is 1MHz for the CLK pin.

3. CLK must remain HIGH for at least 500ns (t_{CH}) after the rising edge of CLK, and CLK must remain LOW for at least 500ns (t_{CL}) after the falling edge of CLK.

4. The serial data bits are sampled at the rising edge of CLK. Any transition on DATA must occur at least 100ns (t_{DS}) before the rising edge of CLK. Also, any transition on DATA must occur at least 100ns (t_{DH}) after the rising edge of CLK and stabilize before the next rising edge of CLK.

5. ID_ENB should be LOW only during serial data transmission.

6. ID_ENB must be LOW at least 100ns (t_{ES}) before the first rising edge of CLK, and ID_ENB has to remain LOW at least 100ns (t_{EH}) after the eighth rising edge of CLK.

7. If ID_ENB remains HIGH for more than 100ns before all 8 bits are transmitted then the data latch will be aborted.

8. If ID_ENB is LOW for more than 8 CLK pulses then only the first 8 data bits will be latched and activated when ID_ENB transitions to logic-high.

9. ID_ENB must remain HIGH for at least 100ns (t_{EL}) to latch in the data.

10. Coincidental rising or falling edges of CLK and ID_ENB are not allowed. If CLK is to be held HIGH after the data transmission, the falling edge of CLK must occur at least 100ns (t_{CS}) before ID_ENB transitions to LOW for the next set of data.

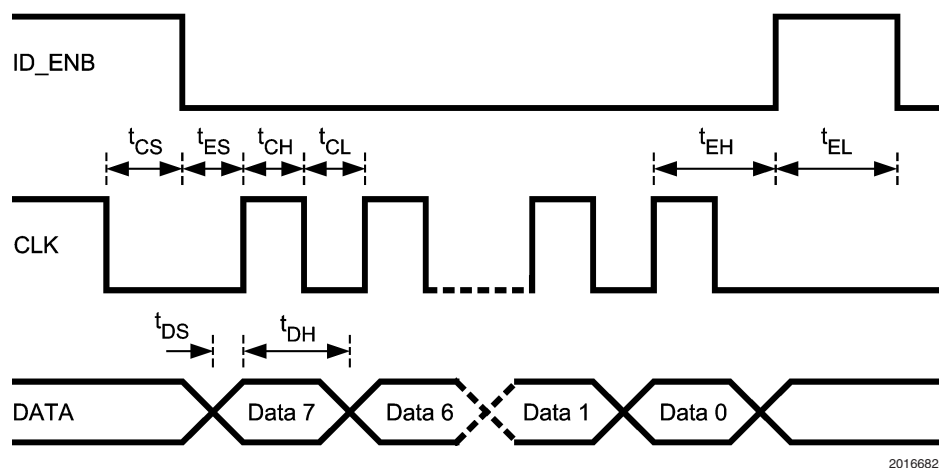

FIGURE 5. SPI Timing Diagram

Application Information (Continued)

TABLE 1. Chip Address

	A7	A6	A5	A4	A3	A2	A1	A0
Chip Address	1	1	1	1	1	0	EC	0
ID_ENB = 0	1	1	1	1	1	0	0	0
ID_ENB = 1	1	1	1	1	1	0	1	0

TABLE 2. Control Registers

	D7	D6	D5	D4	D3	D2	D1	D0
Mode Control	0	0	0	0	OCL	MC2	MC1	MC0
Programmable 3D	0	1	0	0	N3D3	N3D2	N3D1	N3D0
Mono Volume Control	1	0	0	MVC4	MVC3	MVC2	MVC1	MVC0
Left Volume Control	1	1	0	LVC4	LVC3	LVC2	LVC1	LVC0
Right Volume Control	1	1	1	RVC4	RVC3	RVC2	RVC1	RVC0

1. Bits MVC0 — MVC4 control 32 step volume control for MONO input
2. Bits LVC0 — LVC4 control 32 step volume control for LEFT input
3. Bits RVC0 — RVC4 control 32 step volume control for RIGHT input
4. Bits MC0 — MC2 control 8 distinct modes
5. Bits N3D3, N3D2, N3D1, N3D0 control programmable 3D function
6. N3D0 turns the 3D function ON (N3D0 = 1) or OFF (N3D0 = 0), and N3D1 = 0 provides a "wider" aural effect or N3D1 = 1 a "narrower" aural effect
7. Bit OCL selects between SE with output capacitor (OCL = 0) or SE without output capacitors (OCL = 1). **Default is OCL = 0**
8. N3D1 selects between two different 3D configurations

TABLE 3. Programmable National 3D Audio

	N3D3	N3D2
Low	0	0
Medium	0	1
High	1	0
Maximum	1	1

TABLE 4. Output Mode Selection

Output Mode Number	MC2	MC1	MC0	Handsfree Speaker Output	Right HP Output	Left HP Output
0	0	0	0	SD	SD	SD
1	0	0	1	$2 \times G_P \times P$	MUTE	MUTE
2	0	1	0	SD	$G_P \times P$	$G_P \times P$
3	0	1	1	$2 \times (G_L \times L + G_R \times R)$	MUTE	MUTE
4	1	0	0	SD	$G_R \times R$	$G_L \times L$
5	1	0	1	$2 \times (G_L \times L + G_R \times R + G_P \times P)$	MUTE	MUTE
6	1	1	0	SD	$G_R \times R + G_P \times P$	$G_L \times L + G_P \times P$
7	1	1	1	$2 \times (G_R \times R + G_L \times L)$	$G_R \times R$	$G_L \times L$

On initial POWER ON, the default mode is 000

P = Phone in

R = R_{IN}

L = L_{IN}

SD = Shutdown

MUTE = Mute Mode

G_P = Phone In (Mono) volume control gain

G_R = Right stereo volume control gain

G_L = Left stereo volume control gain

Application Information (Continued)

TABLE 5. Volume Control Table

Volume Step	xVC4	xVC3	xVC2	xVC1	xVC0	Headphone Gain, dB	Speaker Gain, dB (BTL)
1	0	0	0	0	0	-54.00	-48.00
2	0	0	0	0	1	-46.50	-40.50
3	0	0	0	1	0	-40.50	-34.50
4	0	0	0	1	1	-34.50	-28.50
5	0	0	1	0	0	-30.00	-24.00
6	0	0	1	0	1	-27.00	-21.00
7	0	0	1	1	0	-24.00	-18.00
8	0	0	1	1	1	-21.00	-15.00
9	0	1	0	0	0	-18.00	-12.00
10	0	1	0	0	1	-15.00	-9.00
11	0	1	0	1	0	-13.50	-7.50
12	0	1	0	1	1	-12.00	-6.00
13	0	1	1	0	0	-10.50	-4.50
14	0	1	1	0	1	-9.00	-3.00
15	0	1	1	1	0	-7.50	-1.50
16	0	1	1	1	1	-6.00	0.00
17	1	0	0	0	0	-4.50	1.50
18	1	0	0	0	1	-3.00	3.00
19	1	0	0	1	0	-1.50	4.50
20	1	0	0	1	1	0.00	6.00
21	1	0	1	0	0	1.50	7.50
22	1	0	1	0	1	3.00	9.00
23	1	0	1	1	0	4.50	10.50
24	1	0	1	1	1	6.00	12.00
25	1	1	0	0	0	7.50	13.50
26	1	1	0	0	1	9.00	15.00
27	1	1	0	1	0	10.50	16.50
28	1	1	0	1	1	12.00	18.00
29	1	1	1	0	0	13.50	19.50
30	1	1	1	0	1	15.00	21.00
31	1	1	1	1	0	16.50	22.50
32	1	1	1	1	1	18.00	24.00

1. x = M, L, or R

2. Gain / Attenuation is from input to output

Application Information (Continued)

NATIONAL 3D ENHANCEMENT

The LM4846 features a stereo headphone, 3D audio enhancement effect that widens the perceived soundstage from a stereo audio signal. The 3D audio enhancement creates a perceived spatial effect optimized for stereo headphone listening. The LM4846 can be programmed for a “narrow” or “wide” soundstage perception. The narrow soundstage has a more focused approaching sound direction, while the wide soundstage has a spatial, theater-like effect. Within each of these two modes, four discrete levels of 3D effect that can be programmed: low, medium, high, and maximum (Table 2), each level with an ever increasing aural effect, respectively. The difference between each level is 3dB.

The external capacitors, shown in Figure 6, are required to enable the 3D effect. The value of the capacitors set the cutoff frequency of the 3D effect, as shown by Equations 1 and 2. Note that the internal 20kΩ resistor is nominal (±25%).

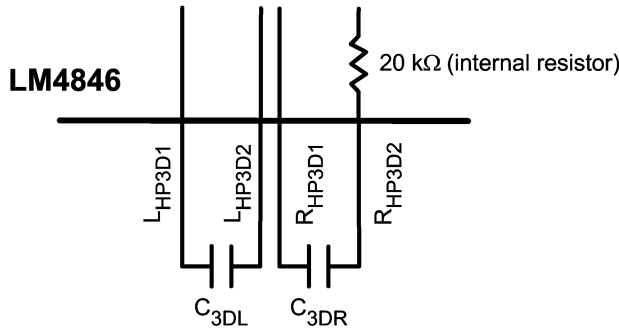

FIGURE 6. External 3D Effect Capacitors

$$f_{3DL(-3dB)} = 1 / 2\pi * 20k\Omega * C_{3DL} \quad (1)$$

$$f_{3DR(-3dB)} = 1 / 2\pi * 20k\Omega * C_{3DR} \quad (2)$$

Optional resistors R_{3DL} and R_{3DR} can also be added (Figure 7) to affect the -3dB frequency and 3D magnitude.

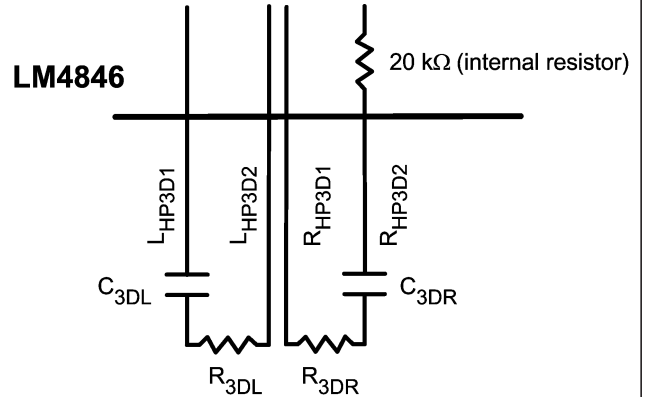

FIGURE 7. External RC Network with Optional R_{3DL} and R_{3DR} Resistors

$$f_{3DL(-3dB)} = 1 / 2\pi * (20k\Omega + R_{3DL}) * C_{3DL} \quad (3)$$

$$f_{3DR(-3dB)} = 1 / 2\pi * (20k\Omega + R_{3DR}) * C_{3DR} \quad (4)$$

ΔAV (change in AC gain) = 1 / 1 + M, where M represents some ratio of the nominal internal resistor, 20kΩ (see example below).

$$f_{3dB} (3D) = 1 / 2\pi (1 + M)(20k\Omega * C_{3D}) \quad (5)$$

$$C_{Equivalent} (new) = C_{3D} / 1 + M \quad (6)$$

TABLE 6. Pole Locations

R _{3D} (kΩ) (optional)	C _{3D} (nF)	M	ΔAV (dB)	f-3dB (3D) (Hz)	Value of C _{3D} to keep same pole location (nF)	new Pole Location (Hz)
0	68	0	0	117		
1	68	0.05	-0.4	111	64.8	117
5	68	0.25	-1.9	94	54.4	117
10	68	0.50	-3.5	78	45.3	117
20	68	1.00	-6.0	59	34.0	117

PCB LAYOUT AND SUPPLY REGULATION CONSIDERATIONS FOR DRIVING 8Ω LOAD

Power dissipated by a load is a function of the voltage swing across the load and the load's impedance. As load impedance decreases, load dissipation becomes increasingly dependent on the interconnect (PCB trace and wire) resistance between the amplifier output pins and the load's connections. Residual trace resistance causes a voltage drop, which results in power dissipated in the trace and not in the load as desired. For example, 0.1Ω trace resistance reduces

the output power dissipated by an 8Ω load from 158.3mW to 156.4mW. The problem of decreased load dissipation is exacerbated as load impedance decreases. Therefore, to maintain the highest load dissipation and widest output voltage swing, PCB traces that connect the output pins to a load must be as wide as possible.

Poor power supply regulation adversely affects maximum output power. A poorly regulated supply's output voltage decreases with increasing load current. Reduced supply voltage causes decreased headroom, output signal clipping,

Application Information (Continued)

and reduced output power. Even with tightly regulated supplies, trace resistance creates the same effects as poor supply regulation. Therefore, making the power supply traces as wide as possible helps maintain full output voltage swing.

BRIDGE CONFIGURATION EXPLANATION

The LM4846 drives a load, such as a speaker, connected between outputs, MONO+ and MONO-.

This results in both amplifiers producing signals identical in magnitude, but 180° out of phase. Taking advantage of this phase difference, a load is placed between MONO- and MONO+ and driven differentially (commonly referred to as "bridge mode"). This results in a differential or BTL gain of:

$$A_{VD} = 2(R_f / R_i) = 2 \quad (7)$$

Bridge mode amplifiers are different from single-ended amplifiers that drive loads connected between a single amplifier's output and ground. For a given supply voltage, bridge mode has a distinct advantage over the single-ended configuration: its differential output doubles the voltage swing across the load. Theoretically, this produces four times the output power when compared to a single-ended amplifier under the same conditions. This increase in attainable output power assumes that the amplifier is not current limited and that the output signal is not clipped.

Another advantage of the differential bridge output is no net DC voltage across the load. This is accomplished by biasing MONO- and MONO+ outputs at half-supply. This eliminates the coupling capacitor that single supply, single-ended amplifiers require. Eliminating an output coupling capacitor in a typical single-ended configuration forces a single-supply amplifier's half-supply bias voltage across the load. This increases internal IC power dissipation and may permanently damage loads such as speakers.

POWER DISSIPATION

Power dissipation is a major concern when designing a successful single-ended or bridged amplifier.

A direct consequence of the increased power delivered to the load by a bridge amplifier is higher internal power dissipation. The LM4846 has a pair of bridged-tied amplifiers driving a handsfree speaker, MONO. The maximum internal power dissipation operating in the bridge mode is twice that of a single-ended amplifier. From Equation (8), assuming a 5V power supply and an 8Ω load, the maximum MONO power dissipation is 634mW.

$$P_{\text{D}_{\text{MAX-SPKROUT}}} = 4(V_{\text{DD}})^2 / (2\pi^2 R_L): \text{ Bridge Mode} \quad (8)$$

The LM4846 also has a pair of single-ended amplifiers driving stereo headphones, R_{OUT} and L_{OUT}. The maximum internal power dissipation for R_{OUT} and L_{OUT} is given by equation (9) and (10). From Equations (9) and (10), assuming a 5V power supply and a 32Ω load, the maximum power dissipation for L_{OUT} and R_{OUT} is 40mW, or 80mW total.

$$P_{\text{D}_{\text{MAX-LOUT}}} = (V_{\text{DD}})^2 / (2\pi^2 R_L): \text{ Single-ended Mode} \quad (9)$$

$$P_{\text{D}_{\text{MAX-ROUT}}} = (V_{\text{DD}})^2 / (2\pi^2 R_L): \text{ Single-ended Mode} \quad (10)$$

The maximum internal power dissipation of the LM4846 occurs when all 3 amplifiers pairs are simultaneously on; and is given by Equation (11).

$$P_{\text{D}_{\text{MAX-TOTAL}}} = P_{\text{D}_{\text{MAX-SPKROUT}}} + P_{\text{D}_{\text{MAX-LOUT}}} + P_{\text{D}_{\text{MAX-ROUT}}} \quad (11)$$

The maximum power dissipation point given by Equation (11) must not exceed the power dissipation given by Equation (12):

$$P_{\text{D}_{\text{MAX}}} = (T_{\text{J}_{\text{MAX}}} - T_{\text{A}}) / \theta_{\text{JA}} \quad (12)$$

The LM4846's T_{JMAX} = 150°C. In the ITL package, the LM4846's θ_{JA} is 65°C/W. At any given ambient temperature T_A, use Equation (12) to find the maximum internal power dissipation supported by the IC packaging. Rearranging Equation (12) and substituting P_{D_{MAX-TOTAL}} for P_{D_{MAX}} results in Equation (13). This equation gives the maximum ambient temperature that still allows maximum stereo power dissipation without violating the LM4846's maximum junction temperature.

$$T_{\text{A}} = T_{\text{J}_{\text{MAX}}} - P_{\text{D}_{\text{MAX-TOTAL}}} \theta_{\text{JA}} \quad (13)$$

For a typical application with a 5V power supply and an 8Ω load, the maximum ambient temperature that allows maximum stereo power dissipation without exceeding the maximum junction temperature is approximately 104°C for the ITL package.

$$T_{\text{J}_{\text{MAX}}} = P_{\text{D}_{\text{MAX-TOTAL}}} \theta_{\text{JA}} + T_{\text{A}} \quad (14)$$

Equation (14) gives the maximum junction temperature T_{JMAX}. If the result violates the LM4846's 150°C, reduce the maximum junction temperature by reducing the power supply voltage or increasing the load resistance. Further allowance should be made for increased ambient temperatures.

The above examples assume that a device is a surface mount part operating around the maximum power dissipation point. Since internal power dissipation is a function of output power, higher ambient temperatures are allowed as output power or duty cycle decreases. If the result of Equation (11) is greater than that of Equation (12), then decrease the supply voltage, increase the load impedance, or reduce the ambient temperature. If these measures are insufficient, a heat sink can be added to reduce θ_{JA}. The heat sink can be created using additional copper area around the package, with connections to the ground pin(s), supply pin and amplifier output pins. External, solder attached SMT heatsinks such as the Thermalloy 7106D can also improve power dissipation. When adding a heat sink, the θ_{JA} is the sum of θ_{JC}, θ_{CS}, and θ_{SA}. (θ_{JC} is the junction-to-case thermal impedance, θ_{CS} is the case-to-sink thermal impedance, and θ_{SA} is the sink-to-ambient thermal impedance). Refer to the Typical Performance Characteristics curves for power dissipation information at lower output power levels.

POWER SUPPLY BYPASSING

As with any power amplifier, proper supply bypassing is critical for low noise performance and high power supply rejection. Applications that employ a 5V regulator typically use a 1μF in parallel with a 0.1μF filter capacitors to stabilize the regulator's output, reduce noise on the supply line, and improve the supply's transient response. However, their presence does not eliminate the need for a local 1.1μF tantalum bypass capacitance connected between the

Application Information (Continued)

LM4846's supply pins and ground. Keep the length of leads and traces that connect capacitors between the LM4846's power supply pin and ground as short as possible. Connecting a 2.2 μ F capacitor, C_B , between the BYPASS pin and ground improves the internal bias voltage's stability and improves the amplifier's PSRR. The PSRR improvements increase as the bypass pin capacitor value increases. Too large, however, increases turn-on time and can compromise the amplifier's click and pop performance. The selection of bypass capacitor values, especially C_B , depends on desired PSRR requirements, click and pop performance (as explained in the section, Proper Selection of External Components), system cost, and size constraints.

SELECTING EXTERNAL COMPONENTS

Input Capacitor Value Selection

Amplifying the lowest audio frequencies requires high value input coupling capacitor (C_i in Figures 1 & 2). A high value capacitor can be expensive and may compromise space efficiency in portable designs. In many cases, however, the speakers used in portable systems, whether internal or external, have little ability to reproduce signals below 150Hz. Applications using speakers with this limited frequency response reap little improvement by using large input capacitor.

The internal input resistor (R_i), nominal 20k Ω , and the input capacitor (C_i) produce a high pass filter cutoff frequency that is found using Equation (15).

$$f_c = 1 / (2\pi R_i C_i) \quad (15)$$

As an example when using a speaker with a low frequency limit of 150Hz, C_i , using Equation (15) is 0.053 μ F. The 0.22 μ F C_i shown in *Figure 1* allows the LM4846 to drive high efficiency, full range speaker whose response extends below 40Hz.

Bypass Capacitor Value Selection

Besides minimizing the input capacitor size, careful consideration should be paid to value of C_B , the capacitor connected to the BYPASS bump. Since C_B determines how fast the LM4846 settles to quiescent operation, its value is critical when minimizing turn-on pops. The slower the LM4846's outputs ramp to their quiescent DC voltage (nominally $V_{DD}/2$), the smaller the turn-on pop. Choosing C_B equal to 1.0 μ F along with a small value of C_i (in the range of 0.1 μ F to 0.39 μ F), produces a click-less and pop-less shutdown function. As discussed above, choosing C_i no larger than necessary for the desired bandwidth helps minimize clicks and pops. C_B 's value should be in the range of 5 times to 7 times the value of C_i . This ensures that output transients are eliminated when power is first applied or the LM4846 resumes operation after shutdown.

Application Information (Continued)

LM4846 TL DEMO BOARD ARTWORK

Top Overlay

NATIONAL SEMICONDUCTOR
LM4846 TL Audio Subsystem with Programmable 3D

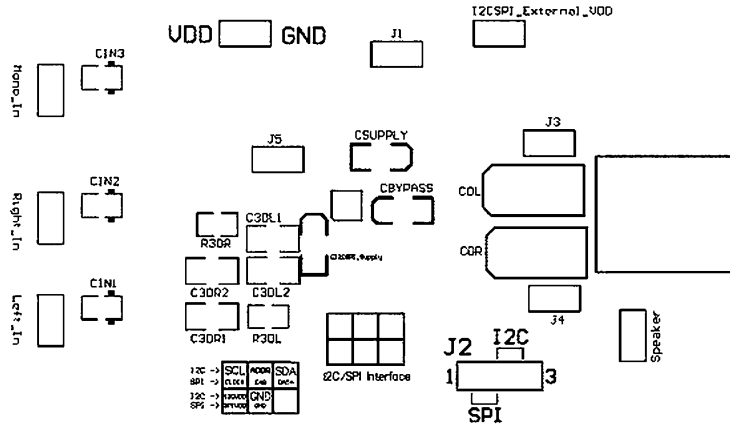

	J5	J4	J3	J2	J1
SE	SHORT	OPEN	OPEN		
OCL	OPEN	SHORT	SHORT		
I2C				2-3	
SPI				1-2	
I2CSPi_UDD					SHORT
I2CSPi_External_UDD					OPEN

20166806

Top Layer

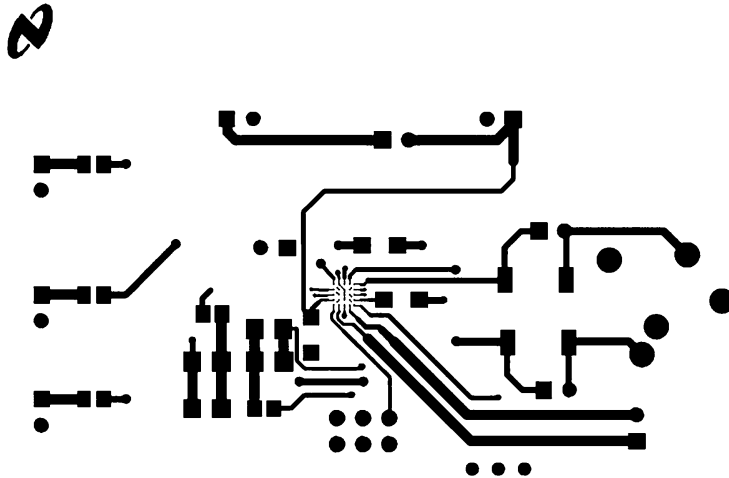

20166805

Application Information (Continued)

Bottom Layer

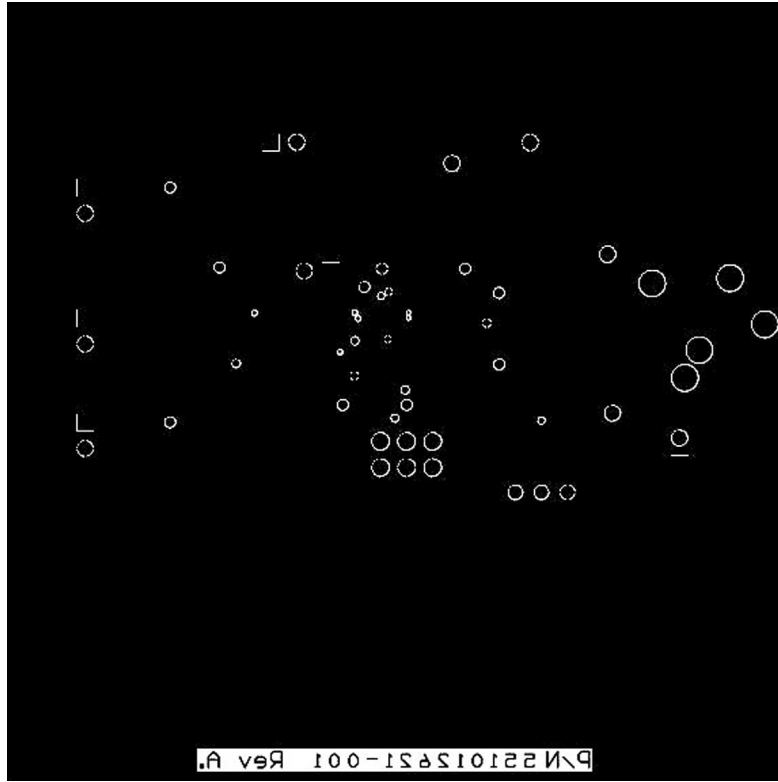

20166804

Revision History

Rev	Date	Description
1.0	11/10/05	1st WEB released.
1.1	12/21/05	Edited the X1, X2, and X3 in the mktg outline, then re-released D/S to the WEB.
1.2	01/13/06	Added the Typ. Perf. curves, then released D/S to the WEB.
1.3	07/06/06	Added the Twu row on the 3.3V and 5.0V EC tables (per Allan S.), then re-released D/S to the WEB.

Physical Dimensions inches (millimeters) unless otherwise noted

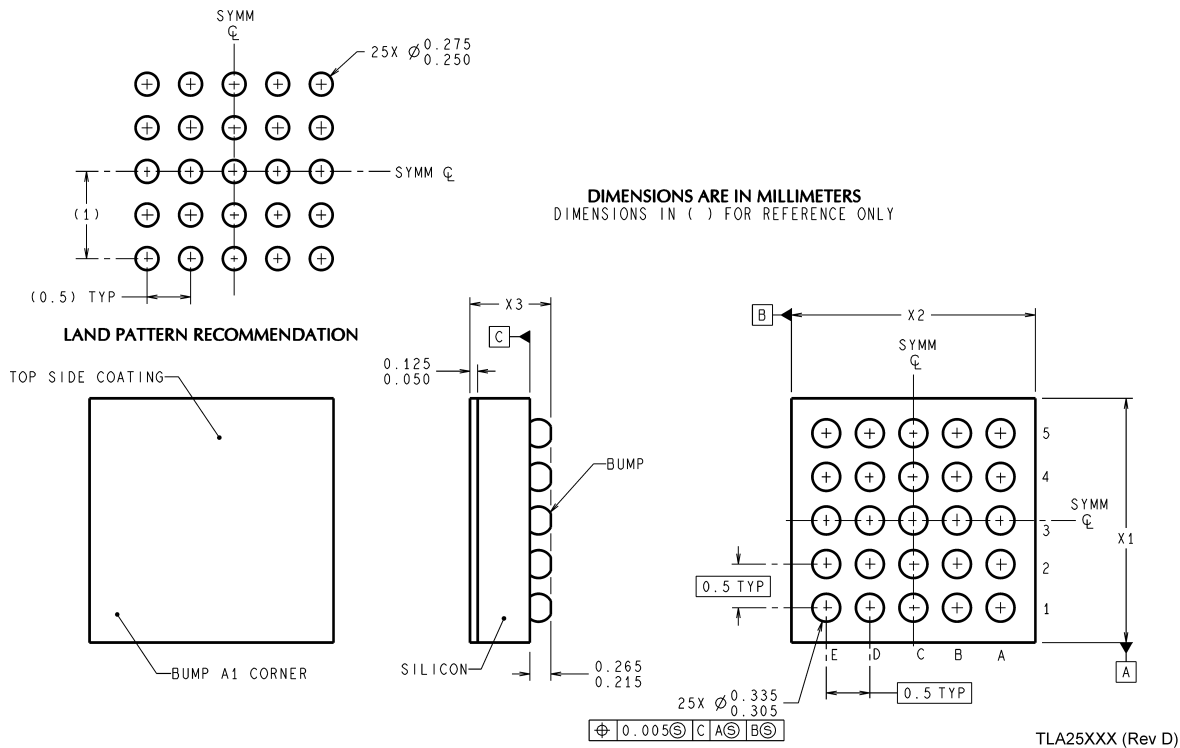

25 – Bump micro SMD
Order Number LM4846TL
NS Package Number TLA25CBA
Dimensions are in millimeters
 $X_1 = 2.543 \pm 0.03$ $X_2 = 2.517 \pm 0.03$ $X_3 = 0.600 \pm 0.075$

National does not assume any responsibility for use of any circuitry described, no circuit patent licenses are implied and National reserves the right at any time without notice to change said circuitry and specifications.

For the most current product information visit us at www.national.com.

LIFE SUPPORT POLICY

NATIONAL'S PRODUCTS ARE NOT AUTHORIZED FOR USE AS CRITICAL COMPONENTS IN LIFE SUPPORT DEVICES OR SYSTEMS WITHOUT THE EXPRESS WRITTEN APPROVAL OF THE PRESIDENT AND GENERAL COUNSEL OF NATIONAL SEMICONDUCTOR CORPORATION. As used herein:

1. Life support devices or systems are devices or systems which, (a) are intended for surgical implant into the body, or (b) support or sustain life, and whose failure to perform when properly used in accordance with instructions for use provided in the labeling, can be reasonably expected to result in a significant injury to the user.
2. A critical component is any component of a life support device or system whose failure to perform can be reasonably expected to cause the failure of the life support device or system, or to affect its safety or effectiveness.

BANNED SUBSTANCE COMPLIANCE

National Semiconductor follows the provisions of the Product Stewardship Guide for Customers (CSP-9-111C2) and Banned Substances and Materials of Interest Specification (CSP-9-111S2) for regulatory environmental compliance. Details may be found at: www.national.com/quality/green.

Lead free products are RoHS compliant.



National Semiconductor
Americas Customer
Support Center
 Email: new.feedback@nsc.com
 Tel: 1-800-272-9959

National Semiconductor
Europe Customer Support Center
 Fax: +49 (0) 180-530 85 86
 Email: europe.support@nsc.com
 Deutsch Tel: +49 (0) 69 9508 6208
 English Tel: +44 (0) 870 24 0 2171
 Français Tel: +33 (0) 1 41 91 8790

National Semiconductor
Asia Pacific Customer
Support Center
 Email: ap.support@nsc.com

National Semiconductor
Japan Customer Support Center
 Fax: 81-3-5639-7507
 Email: jpn.feedback@nsc.com
 Tel: 81-3-5639-7560

www.national.com

IMPORTANT NOTICE

Texas Instruments Incorporated and its subsidiaries (TI) reserve the right to make corrections, modifications, enhancements, improvements, and other changes to its products and services at any time and to discontinue any product or service without notice. Customers should obtain the latest relevant information before placing orders and should verify that such information is current and complete. All products are sold subject to TI's terms and conditions of sale supplied at the time of order acknowledgment.

TI warrants performance of its hardware products to the specifications applicable at the time of sale in accordance with TI's standard warranty. Testing and other quality control techniques are used to the extent TI deems necessary to support this warranty. Except where mandated by government requirements, testing of all parameters of each product is not necessarily performed.

TI assumes no liability for applications assistance or customer product design. Customers are responsible for their products and applications using TI components. To minimize the risks associated with customer products and applications, customers should provide adequate design and operating safeguards.

TI does not warrant or represent that any license, either express or implied, is granted under any TI patent right, copyright, mask work right, or other TI intellectual property right relating to any combination, machine, or process in which TI products or services are used. Information published by TI regarding third-party products or services does not constitute a license from TI to use such products or services or a warranty or endorsement thereof. Use of such information may require a license from a third party under the patents or other intellectual property of the third party, or a license from TI under the patents or other intellectual property of TI.

Reproduction of TI information in TI data books or data sheets is permissible only if reproduction is without alteration and is accompanied by all associated warranties, conditions, limitations, and notices. Reproduction of this information with alteration is an unfair and deceptive business practice. TI is not responsible or liable for such altered documentation. Information of third parties may be subject to additional restrictions.

Resale of TI products or services with statements different from or beyond the parameters stated by TI for that product or service voids all express and any implied warranties for the associated TI product or service and is an unfair and deceptive business practice. TI is not responsible or liable for any such statements.

TI products are not authorized for use in safety-critical applications (such as life support) where a failure of the TI product would reasonably be expected to cause severe personal injury or death, unless officers of the parties have executed an agreement specifically governing such use. Buyers represent that they have all necessary expertise in the safety and regulatory ramifications of their applications, and acknowledge and agree that they are solely responsible for all legal, regulatory and safety-related requirements concerning their products and any use of TI products in such safety-critical applications, notwithstanding any applications-related information or support that may be provided by TI. Further, Buyers must fully indemnify TI and its representatives against any damages arising out of the use of TI products in such safety-critical applications.

TI products are neither designed nor intended for use in military/aerospace applications or environments unless the TI products are specifically designated by TI as military-grade or "enhanced plastic." Only products designated by TI as military-grade meet military specifications. Buyers acknowledge and agree that any such use of TI products which TI has not designated as military-grade is solely at the Buyer's risk, and that they are solely responsible for compliance with all legal and regulatory requirements in connection with such use.

TI products are neither designed nor intended for use in automotive applications or environments unless the specific TI products are designated by TI as compliant with ISO/TS 16949 requirements. Buyers acknowledge and agree that, if they use any non-designated products in automotive applications, TI will not be responsible for any failure to meet such requirements.

Following are URLs where you can obtain information on other Texas Instruments products and application solutions:

Products

Audio	www.ti.com/audio
Amplifiers	amplifier.ti.com
Data Converters	dataconverter.ti.com
DLP® Products	www.dlp.com
DSP	dsp.ti.com
Clocks and Timers	www.ti.com/clocks
Interface	interface.ti.com
Logic	logic.ti.com
Power Mgmt	power.ti.com
Microcontrollers	microcontroller.ti.com
RFID	www.ti-rfid.com
OMAP Mobile Processors	www.ti.com/omap
Wireless Connectivity	www.ti.com/wirelessconnectivity

Applications

Communications and Telecom	www.ti.com/communications
Computers and Peripherals	www.ti.com/computers
Consumer Electronics	www.ti.com/consumer-apps
Energy and Lighting	www.ti.com/energy
Industrial	www.ti.com/industrial
Medical	www.ti.com/medical
Security	www.ti.com/security
Space, Avionics and Defense	www.ti.com/space-avionics-defense
Transportation and Automotive	www.ti.com/automotive
Video and Imaging	www.ti.com/video

TI E2E Community Home Page

e2e.ti.com

Mailing Address: Texas Instruments, Post Office Box 655303, Dallas, Texas 75265
Copyright © 2011, Texas Instruments Incorporated

www.BDTIC.com/TI