

TL343 SINGLE LOW-POWER OPERATIONAL AMPLIFIER

SLOS250G – JUNE 1999 – REVISED JANUARY 2005

- Wide Range of Supply Voltages, Single Supply 3 V to 30 V, or Dual Supplies
- Class AB Output Stage
- True Differential-Input Stage
- Low Input Bias Current
- Internal Frequency Compensation
- Short-Circuit Protection

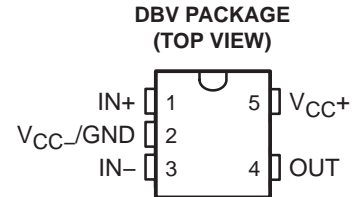

description/ordering information

The TL343 is a single operational amplifier similar in performance to the μ A741, but with several distinct advantages. It is designed to operate from a single supply over a range of voltages from 3 V to 30 V. Operation from split supplies also is possible, provided the difference between the two supplies is 3 V to 30 V. The common-mode input range includes the negative supply. Output range is from the negative supply to $V_{CC} - 1.5$ V.

ORDERING INFORMATION

T_A	$V_{IO\text{MAX}}$ AT 25°C	PACKAGE†	ORDERABLE PART NUMBER	TOP-SIDE MARKING‡
–40°C to 125°C	10 mV	SOT-23-5 (DBV)	Reel of 3000	TL343IDBVR
			Reel of 250	TL343IDBVT
				T4I_

† Package drawings, standard packing quantities, thermal data, symbolization, and PCB design guidelines are available at www.ti.com/sc/package.

‡ The actual top-side marking has one additional character that designates the assembly/test site.

symbol

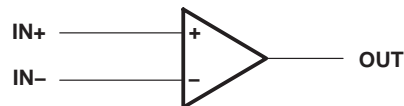

Please be aware that an important notice concerning availability, standard warranty, and use in critical applications of Texas Instruments semiconductor products and disclaimers thereto appears at the end of this data sheet.

PRODUCTION DATA information is current as of publication date. Products conform to specifications per the terms of Texas Instruments standard warranty. Production processing does not necessarily include testing of all parameters.

Copyright © 2005, Texas Instruments Incorporated

www.BDITIC.com/TI

TEXAS INSTRUMENTS
POST OFFICE BOX 655303 • DALLAS, TEXAS 75263

TL343 SINGLE LOW-POWER OPERATIONAL AMPLIFIER

SLOS250G – JUNE 1999 – REVISED JANUARY 2005

schematic

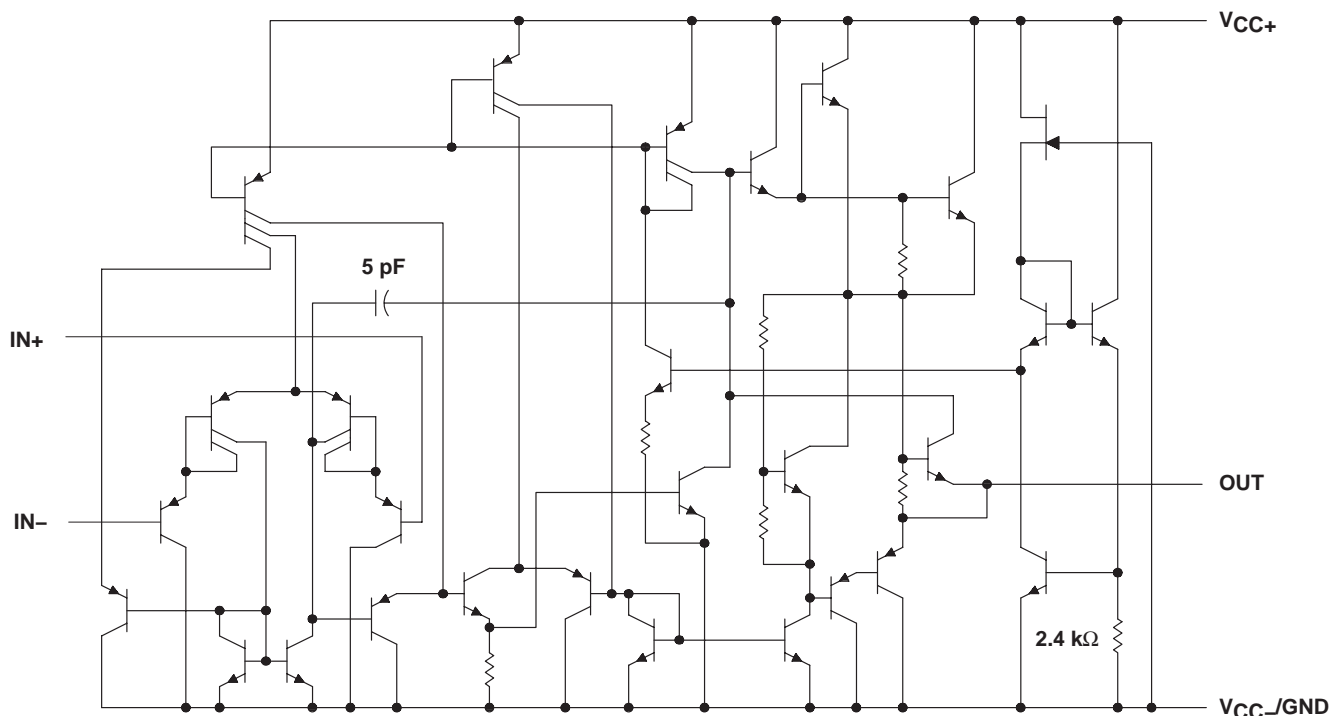

NOTE A: Component values shown are nominal.

absolute maximum ratings over operating free-air temperature range (unless otherwise noted)

	MAX	UNIT	
Supply voltage (see Note 1)	V _{CC+}	18	V
	V _{CC-}	-18	
Supply voltage, V _{CC+} with respect to V _{CC-}	36	V	
Differential input voltage (see Note 2)	±36	V	
Input voltage (see Notes 1 and 3)	±18	V	
Package thermal impedance, θ_{JA} (see Notes 4 and 5)	206	°C/W	
Operating virtual junction temperature, T _J	150	°C	
Storage temperature range, T _{stg}	-65 to 150	°C	

- NOTES:
1. These voltage values are with respect to the midpoint between V_{CC+} and V_{CC-}.
 2. Differential voltages are at IN+ with respect to IN-.
 3. Neither input must ever be more positive than V_{CC+} or more negative than V_{CC-}.
 4. Maximum power dissipation is a function of T_{J(max)}, θ_{JA} , and T_A. The maximum allowable power dissipation at any allowable ambient temperature is P_D = (T_{J(max)} - T_A)/ θ_{JA} . Selecting the maximum of 150°C can affect reliability.
 5. The package thermal impedance is calculated in accordance with JESD 51-7.

TL343 SINGLE LOW-POWER OPERATIONAL AMPLIFIER

SLOS250G – JUNE 1999 – REVISED JANUARY 2005

recommended operating conditions

		MIN	MAX	UNIT
V_{CC}	Single-supply voltage	3	30	V
V_{CC+}	Dual-supply voltage	1.5	15	V
V_{CC-}		-1.5	-15	
T_A	Operating free-air temperature	-40	125	°C

electrical characteristics at specified free-air temperature, $V_{CC\pm} = \pm 15$ V (unless otherwise noted)

PARAMETER		TEST CONDITION [†]		MIN	TYP	MAX	UNIT
V_{IO}	Input offset voltage	See Note 6	25°C		2	10	mV
			Full range			12	
$\alpha_{V_{IO}}$	Temperature coefficient of input offset voltage	See Note 6	Full range		10		$\mu\text{V}/^\circ\text{C}$
I_{IO}	Input offset current	See Note 6	25°C		30	50	nA
			Full range			200	
$\alpha_{I_{IO}}$	Temperature coefficient of input offset current	See Note 6	Full range		50		$\text{pA}/^\circ\text{C}$
I_{IB}	Input bias current	See Note 6	25°C		-200	-500	nA
			Full range			-800	
V_{ICR}	Common-mode input voltage range [‡]		25°C	V_{CC-} to 13	V_{CC-} to 13.5		V
V_{OM}	Peak output-voltage swing	$R_L = 10\text{ k}\Omega$	25°C	± 12	± 13.5		V
			25°C	± 10	± 13		
			Full range	± 10			
A_{VD}	Large-signal differential voltage amplification	$V_O = \pm 10\text{ V}, R_L = 2\text{ k}\Omega$	25°C	20	200		V/mV
			Full range	15			
B_{OM}	Maximum-output-swing bandwidth	$V_{OPP} = 20\text{ V},$ THD $\leq 5\%,$ $R_L = 2\text{ k}\Omega$	25°C		9		kHz
B_1	Unity-gain bandwidth	$V_O = 50\text{ mV}, R_L = 10\text{ k}\Omega$	25°C		1		MHz
ϕ_m	Phase margin	$C_L = 200\text{ pF}, R_L = 2\text{ k}\Omega$	25°C		44		Deg
r_i	Input resistance	$f = 20\text{ Hz}$	25°C	0.3	1		$\text{M}\Omega$
r_o	Output resistance	$f = 20\text{ Hz}$	25°C		75		Ω
CMRR	Common-mode rejection ratio	$V_{IC} = V_{ICR}(\text{min})$	25°C	70	90		dB
k_{SVS}	Supply-voltage sensitivity ($\Delta V_{IO}/\Delta V_{CC}$)	$V_{CC\pm} = \pm 2.5$ to $\pm 15\text{ V}$	25°C		30	150	$\mu\text{V}/\text{V}$
I_{OS}	Short-circuit output current [§]		25°C	± 10	± 30	± 55	mA
I_{CC}	Total supply current	No load, See Note 6	25°C		0.7	2.8	mA

[†] All characteristics are measured under open-loop conditions, with zero common-mode voltage, unless otherwise specified. Full range for T_A is -40°C to 125°C .

[‡] The V_{ICR} limits are linked directly, volt-for-volt, to supply voltage; the positive limit is 2 V less than V_{CC+} .

[§] Temperature and/or supply voltages must be limited to ensure that the dissipation rating is not exceeded.

NOTE 6: V_{IO} , I_{IO} , I_{IB} , and I_{CC} are defined at $V_O = 0$.

TL343

SINGLE LOW-POWER OPERATIONAL AMPLIFIER

SLOS250G – JUNE 1999 – REVISED JANUARY 2005

electrical characteristics, $V_{CC+} = 3\text{ V}$ and 5 V , $V_{CC-} = 0\text{ V}$, $T_A = 25^\circ\text{C}$ (unless otherwise noted)

PARAMETER	TEST CONDITION†	MIN	TYP	MAX	UNIT
V_{IO} Input offset voltage	$V_O = 1.5\text{ V}$ and 2.5 V		2	10	mV
I_{IO} Input offset current	$V_O = 1.5\text{ V}$ and 2.5 V		30	50	nA
I_{IB} Input bias current	$V_O = 1.5\text{ V}$ and 2.5 V		-200	-500	nA
V_{OM} Peak output voltage swing‡	$R_L = 10\text{ k}\Omega$	3.3	3.5		V
A_{VD} Large-signal differential voltage amplification	$V_O = 1.7\text{ V}$ to 3.3 V , $R_L = 2\text{ k}\Omega$	20	200		V/mV
k_{SVS} Supply-voltage sensitivity ($\Delta V_{IO}/\Delta V_{CC\pm}$)	$V_{CC\pm} = \pm 2.5\text{ V}$ to $\pm 15\text{ V}$			150	$\mu\text{V}/\text{V}$
I_{CC} Supply current	$V_O = 1.5\text{ V}$ and 2.5 V , No load		0.7	1.75	mA

† All characteristics are measured under open-loop conditions, with zero common-mode input voltage, unless otherwise specified.

‡ Output swings essentially to ground.

operating characteristics, $V_{CC\pm} = \pm 15\text{ V}$, $T_A = 25^\circ\text{C}$, $A_{VD} = 1$ (unless otherwise noted)

PARAMETER	TEST CONDITIONS	TYP	UNIT
SR Slew rate at unity gain	$V_I = \pm 10\text{ V}$, $C_L = 100\text{ pF}$, $R_L = 2\text{ k}\Omega$, See Figure 1	1	$\text{V}/\mu\text{s}$
t_r Rise time	$\Delta V_O = 50\text{ mV}$, $C_L = 100\text{ pF}$, $R_L = 10\text{ k}\Omega$, See Figure 1	0.35	μs
t_f Fall time	$\Delta V_O = 50\text{ mV}$, $C_L = 100\text{ pF}$, $R_L = 10\text{ k}\Omega$, See Figure 1	0.35	μs
Overshoot factor	$\Delta V_O = 50\text{ mV}$, $C_L = 100\text{ pF}$, $R_L = 10\text{ k}\Omega$, See Figure 1	20%	
Crossover distortion	$V_{I(PP)} = 30\text{ mV}$, $V_{OPP} = 2\text{ V}$, $f = 10\text{ kHz}$	1%	

PARAMETER MEASUREMENT INFORMATION

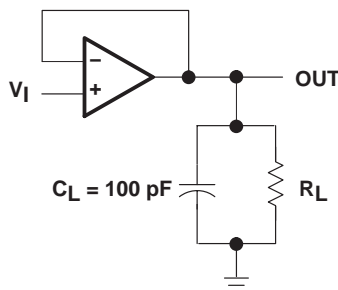

Figure 1. Unity-Gain Amplifier

TYPICAL CHARACTERISTICS†

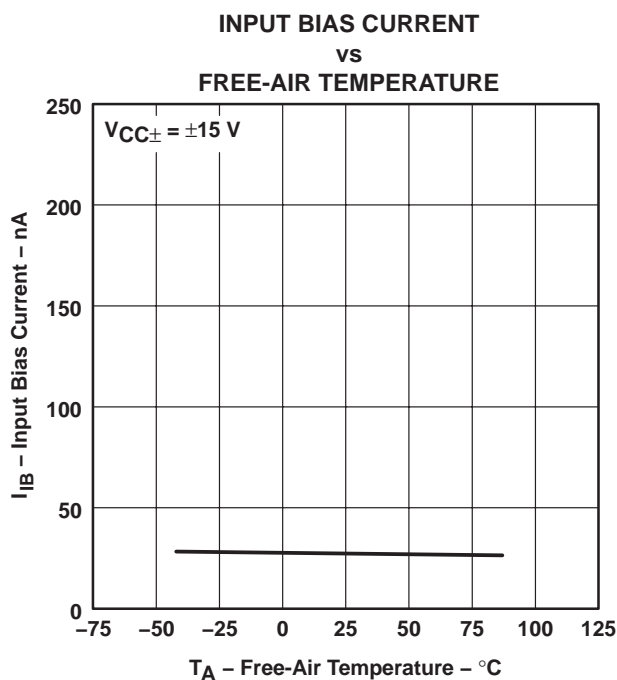

Figure 2

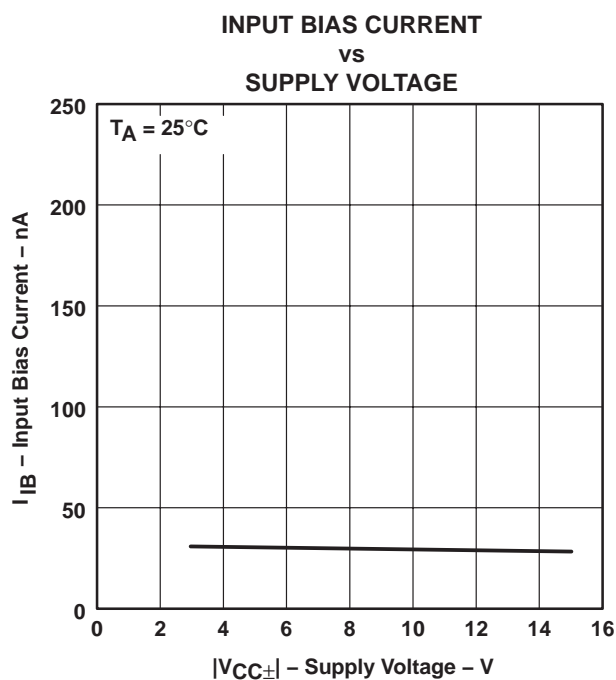

Figure 3

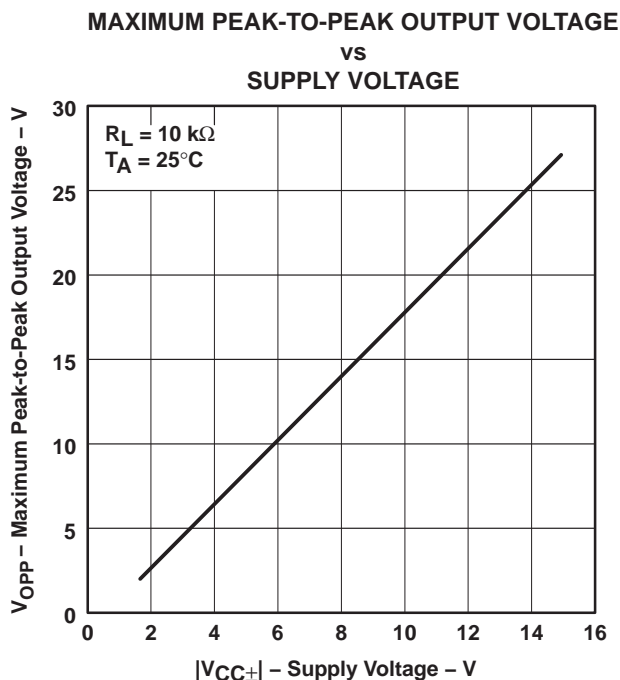

Figure 4

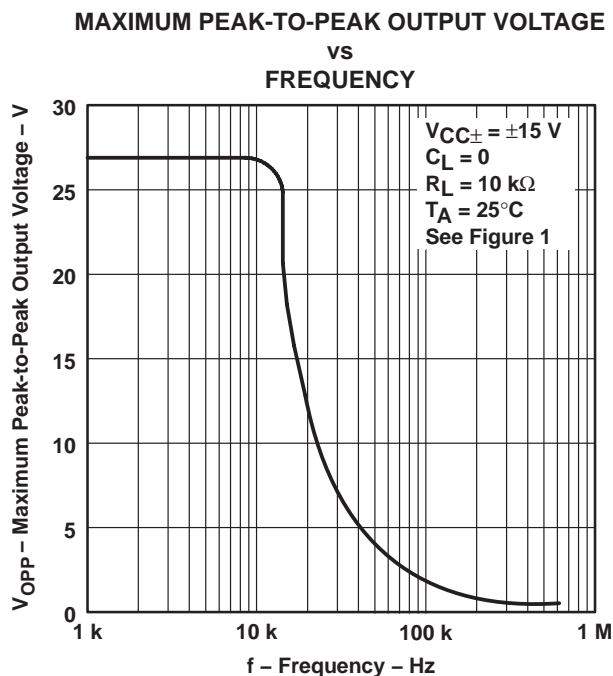

Figure 5

† Operation of the device at these or any other conditions beyond those indicated under "recommended operating conditions" is not implied.

TL343 SINGLE LOW-POWER OPERATIONAL AMPLIFIER

SLOS250G – JUNE 1999 – REVISED JANUARY 2005

TYPICAL CHARACTERISTICS†

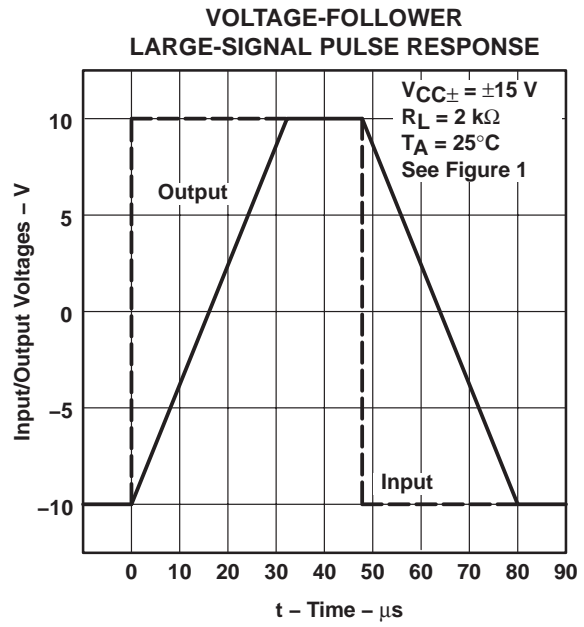
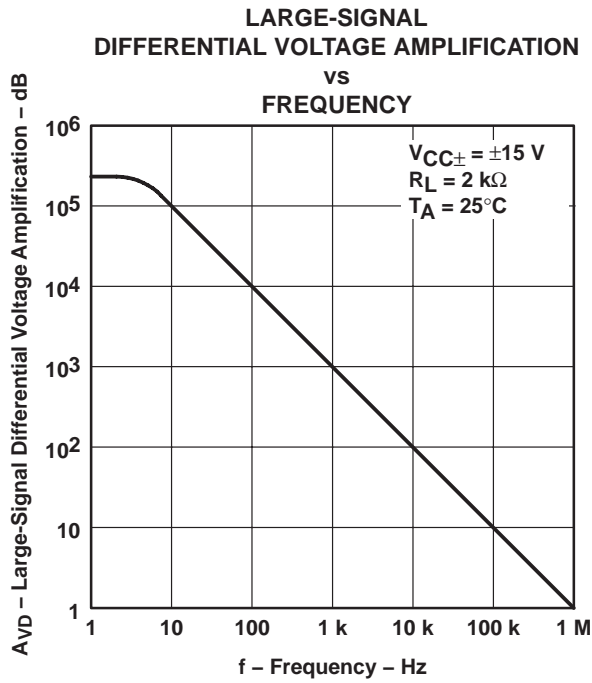

† Operation of the device at these or any other conditions beyond those indicated under "recommended operating conditions" is not implied.

PACKAGING INFORMATION

Orderable Device	Status ⁽¹⁾	Package Type	Package Drawing	Pins	Package Qty	Eco Plan ⁽²⁾	Lead/Ball Finish	MSL Peak Temp ⁽³⁾
TL3431DBVR	ACTIVE	SOT-23	DBV	5	3000	Green (RoHS & no Sb/Br)	CU NIPDAU	Level-1-260C-UNLIM
TL3431DBVRE4	ACTIVE	SOT-23	DBV	5	3000	Green (RoHS & no Sb/Br)	CU NIPDAU	Level-1-260C-UNLIM
TL3431DBVRG4	ACTIVE	SOT-23	DBV	5	3000	Green (RoHS & no Sb/Br)	CU NIPDAU	Level-1-260C-UNLIM
TL3431DBVBT	ACTIVE	SOT-23	DBV	5	250	Green (RoHS & no Sb/Br)	CU NIPDAU	Level-1-260C-UNLIM
TL3431DBVTE4	ACTIVE	SOT-23	DBV	5	250	Green (RoHS & no Sb/Br)	CU NIPDAU	Level-1-260C-UNLIM
TL3431DBVTG4	ACTIVE	SOT-23	DBV	5	250	Green (RoHS & no Sb/Br)	CU NIPDAU	Level-1-260C-UNLIM

⁽¹⁾ The marketing status values are defined as follows:

ACTIVE: Product device recommended for new designs.

LIFEBUY: TI has announced that the device will be discontinued, and a lifetime-buy period is in effect.

NRND: Not recommended for new designs. Device is in production to support existing customers, but TI does not recommend using this part in a new design.

PREVIEW: Device has been announced but is not in production. Samples may or may not be available.

OBSOLETE: TI has discontinued the production of the device.

⁽²⁾ Eco Plan - The planned eco-friendly classification: Pb-Free (RoHS), Pb-Free (RoHS Exempt), or Green (RoHS & no Sb/Br) - please check <http://www.ti.com/productcontent> for the latest availability information and additional product content details.

TBD: The Pb-Free/Green conversion plan has not been defined.

Pb-Free (RoHS): TI's terms "Lead-Free" or "Pb-Free" mean semiconductor products that are compatible with the current RoHS requirements for all 6 substances, including the requirement that lead not exceed 0.1% by weight in homogeneous materials. Where designed to be soldered at high temperatures, TI Pb-Free products are suitable for use in specified lead-free processes.

Pb-Free (RoHS Exempt): This component has a RoHS exemption for either 1) lead-based flip-chip solder bumps used between the die and package, or 2) lead-based die adhesive used between the die and leadframe. The component is otherwise considered Pb-Free (RoHS compatible) as defined above.

Green (RoHS & no Sb/Br): TI defines "Green" to mean Pb-Free (RoHS compatible), and free of Bromine (Br) and Antimony (Sb) based flame retardants (Br or Sb do not exceed 0.1% by weight in homogeneous material)

⁽³⁾ MSL, Peak Temp. -- The Moisture Sensitivity Level rating according to the JEDEC industry standard classifications, and peak solder temperature.

Important Information and Disclaimer:The information provided on this page represents TI's knowledge and belief as of the date that it is provided. TI bases its knowledge and belief on information provided by third parties, and makes no representation or warranty as to the accuracy of such information. Efforts are underway to better integrate information from third parties. TI has taken and continues to take reasonable steps to provide representative and accurate information but may not have conducted destructive testing or chemical analysis on incoming materials and chemicals. TI and TI suppliers consider certain information to be proprietary, and thus CAS numbers and other limited information may not be available for release.

In no event shall TI's liability arising out of such information exceed the total purchase price of the TI part(s) at issue in this document sold by TI to Customer on an annual basis.

TAPE AND REEL INFORMATION

QUADRANT ASSIGNMENTS FOR PIN 1 ORIENTATION IN TAPE

*All dimensions are nominal

Device	Package Type	Package Drawing	Pins	SPQ	Reel Diameter (mm)	Reel Width W1 (mm)	A0 (mm)	B0 (mm)	K0 (mm)	P1 (mm)	W (mm)	Pin1 Quadrant
TL343IDBVR	SOT-23	DBV	5	3000	178.0	9.0	3.23	3.17	1.37	4.0	8.0	Q3
TL343IDBVR	SOT-23	DBV	5	3000	180.0	9.2	3.17	3.23	1.37	4.0	8.0	Q3
TL343IDBVT	SOT-23	DBV	5	250	178.0	9.0	3.23	3.17	1.37	4.0	8.0	Q3
TL343IDBVT	SOT-23	DBV	5	250	180.0	9.2	3.17	3.23	1.37	4.0	8.0	Q3

TAPE AND REEL BOX DIMENSIONS



*All dimensions are nominal

Device	Package Type	Package Drawing	Pins	SPQ	Length (mm)	Width (mm)	Height (mm)
TL3431DBVR	SOT-23	DBV	5	3000	180.0	180.0	18.0
TL3431DBVR	SOT-23	DBV	5	3000	205.0	200.0	33.0
TL3431DBVT	SOT-23	DBV	5	250	180.0	180.0	18.0
TL3431DBVT	SOT-23	DBV	5	250	205.0	200.0	33.0

IMPORTANT NOTICE

Texas Instruments Incorporated and its subsidiaries (TI) reserve the right to make corrections, modifications, enhancements, improvements, and other changes to its products and services at any time and to discontinue any product or service without notice. Customers should obtain the latest relevant information before placing orders and should verify that such information is current and complete. All products are sold subject to TI's terms and conditions of sale supplied at the time of order acknowledgment.

TI warrants performance of its hardware products to the specifications applicable at the time of sale in accordance with TI's standard warranty. Testing and other quality control techniques are used to the extent TI deems necessary to support this warranty. Except where mandated by government requirements, testing of all parameters of each product is not necessarily performed.

TI assumes no liability for applications assistance or customer product design. Customers are responsible for their products and applications using TI components. To minimize the risks associated with customer products and applications, customers should provide adequate design and operating safeguards.

TI does not warrant or represent that any license, either express or implied, is granted under any TI patent right, copyright, mask work right, or other TI intellectual property right relating to any combination, machine, or process in which TI products or services are used. Information published by TI regarding third-party products or services does not constitute a license from TI to use such products or services or a warranty or endorsement thereof. Use of such information may require a license from a third party under the patents or other intellectual property of the third party, or a license from TI under the patents or other intellectual property of TI.

Reproduction of TI information in TI data books or data sheets is permissible only if reproduction is without alteration and is accompanied by all associated warranties, conditions, limitations, and notices. Reproduction of this information with alteration is an unfair and deceptive business practice. TI is not responsible or liable for such altered documentation. Information of third parties may be subject to additional restrictions.

Resale of TI products or services with statements different from or beyond the parameters stated by TI for that product or service voids all express and any implied warranties for the associated TI product or service and is an unfair and deceptive business practice. TI is not responsible or liable for any such statements.

TI products are not authorized for use in safety-critical applications (such as life support) where a failure of the TI product would reasonably be expected to cause severe personal injury or death, unless officers of the parties have executed an agreement specifically governing such use. Buyers represent that they have all necessary expertise in the safety and regulatory ramifications of their applications, and acknowledge and agree that they are solely responsible for all legal, regulatory and safety-related requirements concerning their products and any use of TI products in such safety-critical applications, notwithstanding any applications-related information or support that may be provided by TI. Further, Buyers must fully indemnify TI and its representatives against any damages arising out of the use of TI products in such safety-critical applications.

TI products are neither designed nor intended for use in military/aerospace applications or environments unless the TI products are specifically designated by TI as military-grade or "enhanced plastic." Only products designated by TI as military-grade meet military specifications. Buyers acknowledge and agree that any such use of TI products which TI has not designated as military-grade is solely at the Buyer's risk, and that they are solely responsible for compliance with all legal and regulatory requirements in connection with such use.

TI products are neither designed nor intended for use in automotive applications or environments unless the specific TI products are designated by TI as compliant with ISO/TS 16949 requirements. Buyers acknowledge and agree that, if they use any non-designated products in automotive applications, TI will not be responsible for any failure to meet such requirements.

Following are URLs where you can obtain information on other Texas Instruments products and application solutions:

Products

Audio	www.ti.com/audio
Amplifiers	amplifier.ti.com
Data Converters	dataconverter.ti.com
DLP® Products	www.dlp.com
DSP	dsp.ti.com
Clocks and Timers	www.ti.com/clocks
Interface	interface.ti.com
Logic	logic.ti.com
Power Mgmt	power.ti.com
Microcontrollers	microcontroller.ti.com
RFID	www.ti-rfid.com
RF/IF and ZigBee® Solutions	www.ti.com/lprf

Applications

Communications and Telecom	www.ti.com/communications
Computers and Peripherals	www.ti.com/computers
Consumer Electronics	www.ti.com/consumer-apps
Energy and Lighting	www.ti.com/energy
Industrial	www.ti.com/industrial
Medical	www.ti.com/medical
Security	www.ti.com/security
Space, Avionics and Defense	www.ti.com/space-avionics-defense
Transportation and Automotive	www.ti.com/automotive
Video and Imaging	www.ti.com/video
Wireless	www.ti.com/wireless-apps

TI E2E Community Home Page

e2e.ti.com

Mailing Address: Texas Instruments, Post Office Box 655303, Dallas, Texas 75265
Copyright © 2011, Texas Instruments Incorporated

www.BDTIC.com/TI