

# TLC220x, TLC220xA, TLC220xB, TLC220xY Advanced LinCMOS™ LOW-NOISE PRECISION OPERATIONAL AMPLIFIERS

SLOS175B – FEBRUARY 1997 – REVISED JANUARY 2008

- B Grade Is 100% Tested for Noise  
30 nV/ $\sqrt{\text{Hz}}$  Max at f = 10 Hz  
12 nV/ $\sqrt{\text{Hz}}$  Max at f = 1 kHz
- Low Input Offset Voltage . . . 500  $\mu\text{V}$  Max
- Excellent Offset Voltage Stability  
With Temperature . . . 0.5  $\mu\text{V}/^\circ\text{C}$  Typ
- Rail-to-Rail Output Swing
- Low Input Bias Current  
1 pA Typ at  $T_A = 25^\circ\text{C}$
- Common-Mode Input Voltage Range  
Includes the Negative Rail
- Fully Specified For Both Single-Supply and  
Split-Supply Operation

## description

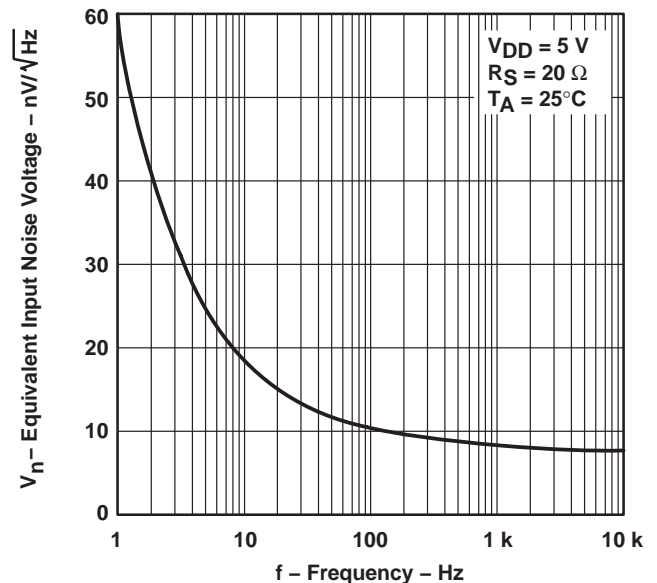
The TLC220x, TLC220xA, TLC220xB, and TLC220xY are precision, low-noise operational amplifiers using Texas Instruments Advanced LinCMOS™ process. These devices combine the noise performance of the lowest-noise JFET amplifiers with the dc precision available previously only in bipolar amplifiers. The Advanced LinCMOS™ process uses silicon-gate technology to obtain input offset voltage stability with temperature and time that far exceeds that obtainable using metal-gate technology. In addition, this technology makes possible input impedance levels that meet or exceed levels offered by top-gate JFET and expensive dielectric-isolated devices.

The combination of excellent DC and noise performance with a common-mode input voltage range that includes the negative rail makes these devices an ideal choice for high-impedance, low-level signal-conditioning applications in either single-supply or split-supply configurations.

The device inputs and outputs are designed to withstand –100-mA surge currents without sustaining latch-up. In addition, internal ESD-protection circuits prevent functional failures at voltages up to 2000 V as tested under MIL-PRF-38535, Method 3015.2; however, care should be exercised in handling these devices as exposure to ESD may result in degradation of the parametric performance.

The C-suffix devices are characterized for operation from 0°C to 70°C. The I-suffix devices are characterized for operation from –40°C to 85°C. The M-suffix devices are characterized for operation over the full military temperature range of –55°C to 125°C.

TYPICAL EQUIVALENT  
INPUT NOISE VOLTAGE  
VS  
FREQUENCY



Please be aware that an important notice concerning availability, standard warranty, and use in critical applications of Texas Instruments semiconductor products and disclaimers thereto appears at the end of this data sheet.

Advanced LinCMOS is a trademark of Texas Instruments Incorporated. All other trademarks are the property of their respective owners.

PRODUCTION DATA information is current as of publication date. Products conform to specifications per the terms of Texas Instruments standard warranty. Production processing does not necessarily include testing of all parameters.



TEXAS  
INSTRUMENTS

[www.BDITC.com/TI](http://www.BDITC.com/TI)

POST OFFICE BOX 655308 • DALLAS, TEXAS 75268

Copyright © 1997–2008, Texas Instruments Incorporated

On products compliant to MIL-PRF-38535, all parameters are tested unless otherwise noted. On all other products, production processing does not necessarily include testing of all parameters.

**TLC220x, TLC220xA, TLC220xB, TLC220xY**  
**Advanced LinCMOS™ LOW-NOISE PRECISION**  
**OPERATIONAL AMPLIFIERS**

SLOS175B – FEBRUARY 1997 – REVISED JANUARY 2008

**TLC2201 AVAILABLE OPTIONS**

T <sub>A</sub>	V <sub>IO</sub> max AT 25°C	V <sub>n</sub> max f = 10 Hz AT 25°C	V <sub>n</sub> max f = 1 kHz AT 25°C	PACKAGED DEVICES				CHIP FORM‡ (Y)
				SMALL OUTLINE† (D)	CHIP CARRIER (FK)	CERAMIC DIP (JG)	PLASTIC DIP (P)	
0°C to 70°C	200 µV	35 nV/√Hz	15 nV/√Hz	TLC2201ACD	—	—	TLC2201ACP	TLC2201Y
	200 µV	30 nV/√Hz	12 nV/√Hz	TLC2201BCD			TLC2201BCP	
	500 µV	—	—	TLC2201CD			TLC2201CP	
–40°C to 85°C	200 µV	35 nV/√Hz	15 nV/√Hz	TLC2201AID	—	—	TLC2201AIP	—
	200 µV	30 nV/√Hz	12 nV/√Hz	TLC2201BID			TLC2201BIP	
	500 µV	—	—	TLC2201ID			TLC2201IP	
–55°C to 125°C	200 µV	35 nV/√Hz	15 nV/√Hz	TLC2201AMD	TLC2201AMFK	TLC2201AMJG	TLC2201AMP	—
	200 µV	30 nV/√Hz	12 nV/√Hz	TLC2201BMD	TLC2201BMFK	TLC2201BMJG	TLC2201BMP	
	500 µV	—	—	TLC2201MD	TLC2201MFK	TLC2201MJG	TLC2201MP	

† The D packages are available taped and reeled. Add R suffix to device type (e.g. TLC220xBCDR).

‡ Chip forms are tested at 25°C only.

**TLC2202 AVAILABLE OPTIONS**

T <sub>A</sub>	V <sub>IO</sub> max AT 25°C	V <sub>n</sub> max f = 10 Hz AT 25°C	V <sub>n</sub> max f = 1 kHz AT 25°C	PACKAGED DEVICES					CHIP FORM‡ (Y)
				SMALL OUTLINE† (D)	PLASTIC SMALL OUTLINE (PS)	CHIP CARRIER (FK)	CERAMIC DIP (JG)	PLASTIC DIP (P)	
0°C to 70°C	500 µV	30 nV/√Hz	12 nV/√Hz	TLC2202BCD	—	—	—	TLC2202BCP	TLC2202Y
	500 µV	35 nV/√Hz	15 nV/√Hz	TLC2202ACD	—	—	—	TLC2202ACP	
	1 mV	—	—	TLC2202CD	TLC2202CPSR	—	—	TLC2202CP	
–40°C to 85°C	500 µV	30 nV/√Hz	12 nV/√Hz	TLC2202BID	—	—	—	TLC2202BIP	—
	500 µV	35 nV/√Hz	15 nV/√Hz	TLC2202AID	—	—	—	TLC2202AIP	
	1 mV	—	—	TLC2202ID	—	—	—	TLC2202IP	
–55°C to 125°C	500 µV	30 nV/√Hz	12 nV/√Hz	TLC2202BMD	—	TLC2202BMFK	TLC2202BMJG	TLC2202BMP	—
	500 µV	35 nV/√Hz	15 nV/√Hz	TLC2202AMD	—	TLC2202AMFK	TLC2202AMJG	TLC2202AMP	
	1 mV	—	—	TLC2202MD	—	TLC2202MFK	TLC2202MJG	TLC2202MP	

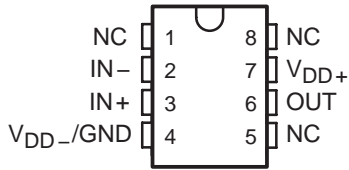
† The D packages are available taped and reeled. Add R suffix to device type (e.g. TLC220xBCDR).

‡ Chip forms are tested at 25°C only.

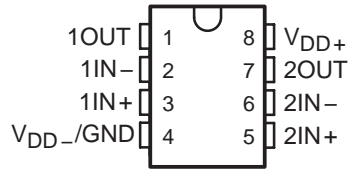
# TLC220x, TLC220xA, TLC220xB, TLC220xY Advanced LinCMOS™ LOW-NOISE PRECISION OPERATIONAL AMPLIFIERS

SLOS175B – FEBRUARY 1997 – REVISED JANUARY 2008

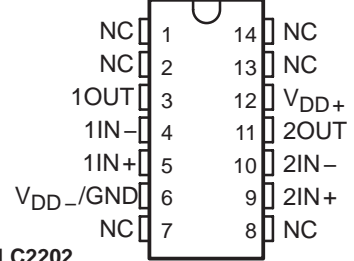
**TLC2201**  
D, JG, OR P PACKAGE  
(TOP VIEW)



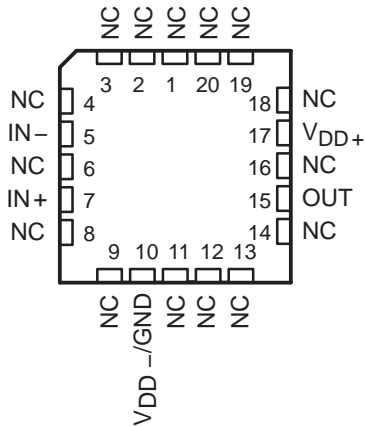
**TLC2202**  
PS, JG, OR P PACKAGE  
(TOP VIEW)



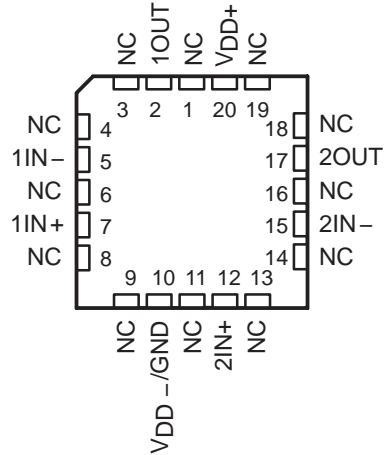
**TLC2202**  
D PACKAGE  
(TOP VIEW)



**TLC2201**  
FK PACKAGE  
(TOP VIEW)



**TLC2202**  
FK PACKAGE  
(TOP VIEW)

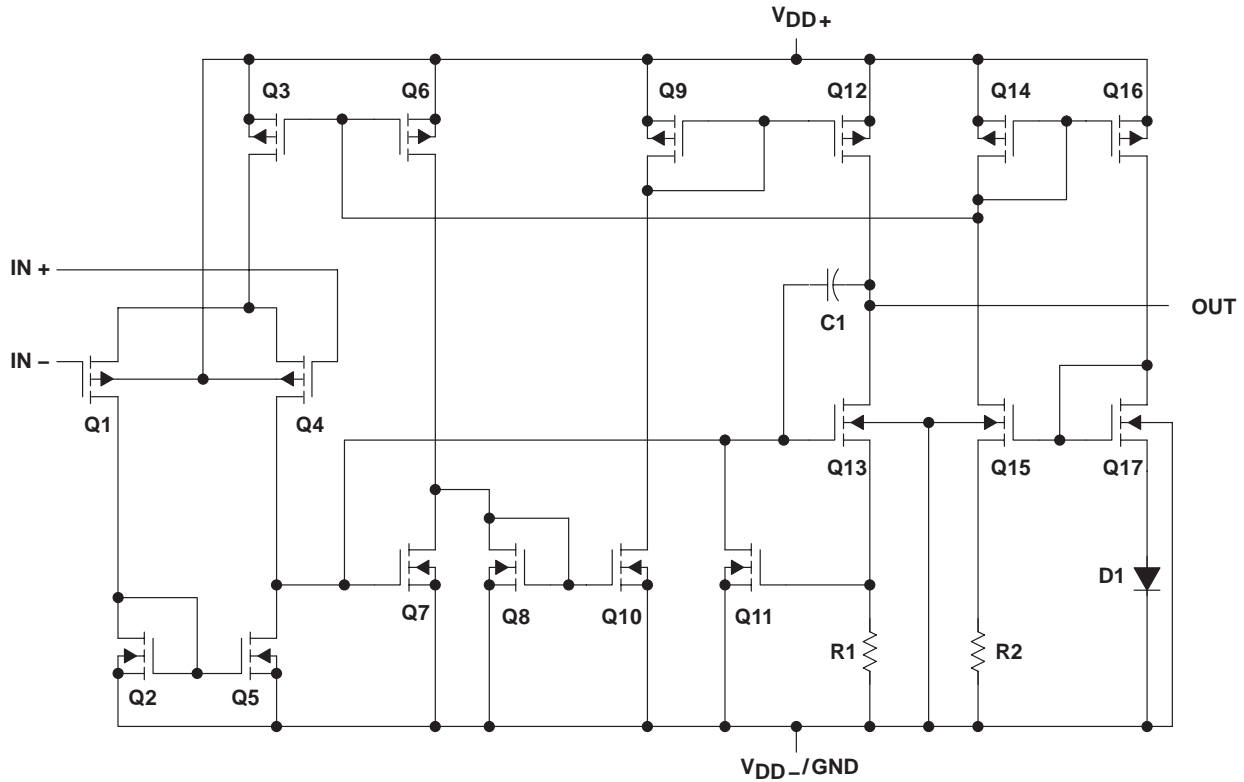


NC – No internal connection

**TLC220x, TLC220xA, TLC220xB, TLC220xY**  
**Advanced LinCMOS™ LOW-NOISE PRECISION**  
**OPERATIONAL AMPLIFIERS**

SLOS175B – FEBRUARY 1997 – REVISED JANUARY 2008

equivalent schematic (each amplifier)



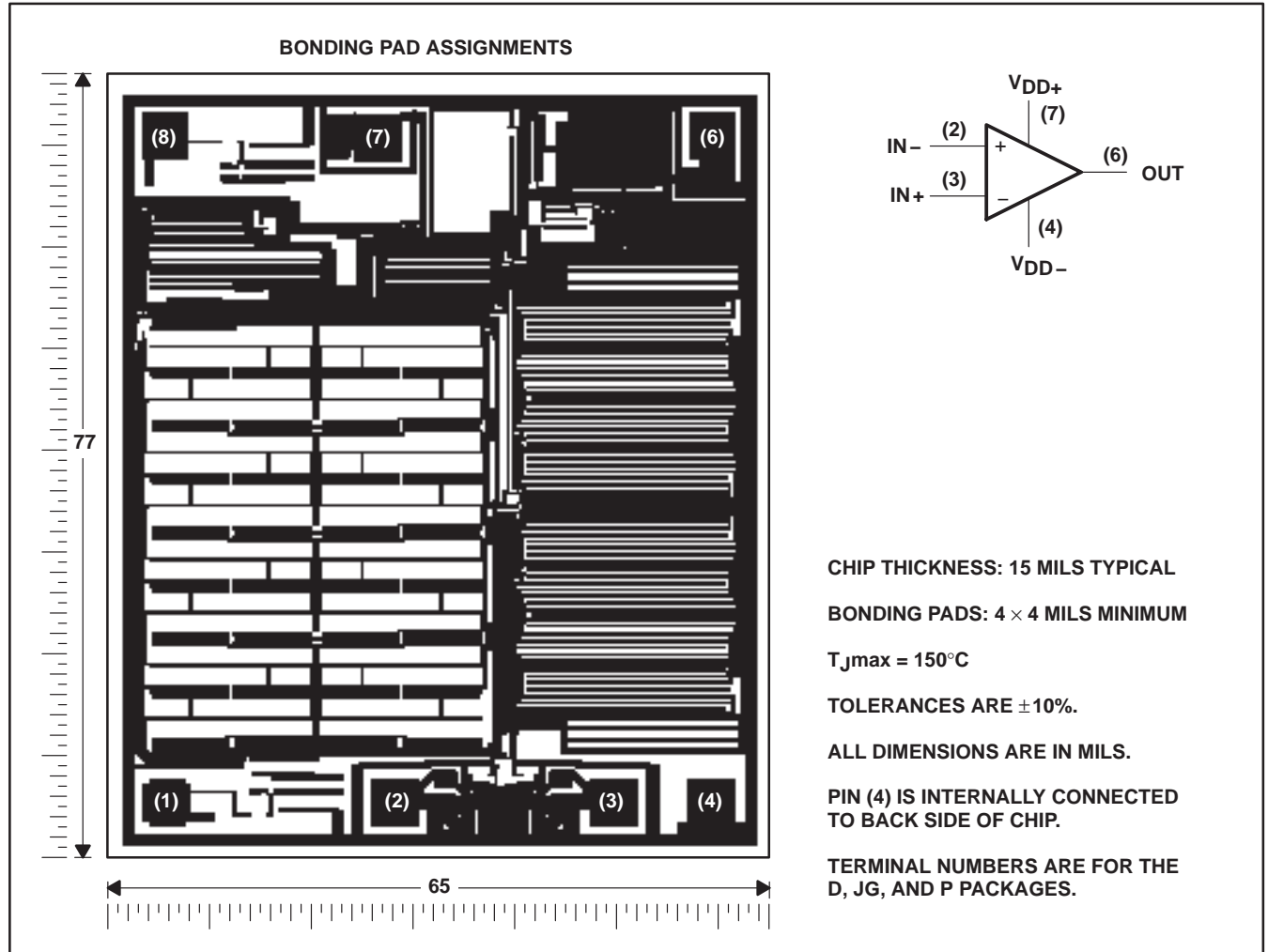
ACTUAL DEVICE COMPONENT COUNT		
COMPONENT	TLC2201	TLC2202
Transistors	17	34
Resistors	2	2
Diodes	1	4
Capacitors	1	2

**TLC220x, TLC220xA, TLC220xB, TLC220xY**  
**Advanced LinCMOS™ LOW-NOISE PRECISION**  
**OPERATIONAL AMPLIFIERS**

SLOS175B – FEBRUARY 1997 – REVISED JANUARY 2008

**TLC2201Y chip information**

This chip, when properly assembled, displays characteristics similar to the TLC2201C. Thermal compression or ultrasonic bonding may be used on the doped-aluminum bonding path. Chips may be mounted with conductive epoxy or a gold-silicon preform.

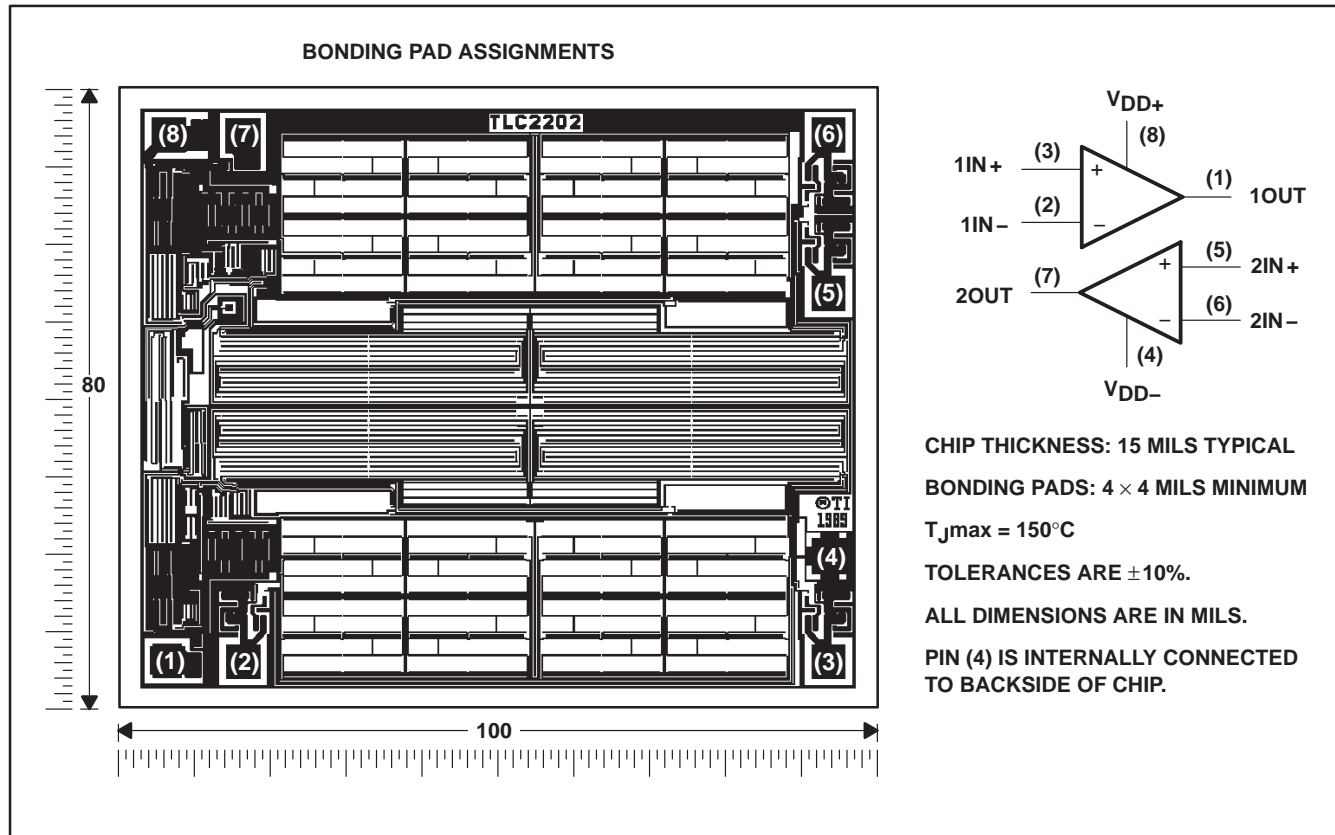


**TLC220x, TLC220xA, TLC220xB, TLC220xY**  
**Advanced LinCMOS™ LOW-NOISE PRECISION**  
**OPERATIONAL AMPLIFIERS**

SLOS175B – FEBRUARY 1997 – REVISED JANUARY 2008

**TLC2202Y chip formation**

This chip, when properly assembled, displays characteristics similar to the TLC2202C. Thermal compression or ultrasonic bonding may be used on the doped-aluminum bonding pads. Chips may be mounted with conductive epoxy or a gold-silicon preform.



# TLC220x, TLC220xA, TLC220xB, TLC220xY Advanced LinCMOS™ LOW-NOISE PRECISION OPERATIONAL AMPLIFIERS

SLOS175B – FEBRUARY 1997 – REVISED JANUARY 2008

## absolute maximum ratings over operating free-air temperature range (unless otherwise noted)†

Supply voltage, $V_{DD+}$ (see Note 1)	8 V
Supply voltage, $V_{DD-}$	–8 V
Differential input voltage, $V_{ID}$ (see Note 2)	±16 V
Input voltage, $V_I$ (any input)	±8 V
Input current, $I_I$ (each input)	±5 mA
Output current, $I_O$ (each output)	±50 mA
Duration of short-circuit current at (or below) 25°C (see Note 3)	unlimited
Continuous total dissipation	See Dissipation Rating Table
Operating free-air temperature range, $T_A$ : C suffix	0°C to 70°C
I suffix	–40°C to 85°C
M suffix	–55°C to 125°C
Storage temperature range	–65°C to 150°C
Case temperature for 60 seconds: FK package	260°C
Lead temperature 1,6 mm (1/16 inch) from case for 10 seconds: D, PS, or P package	260°C
Lead temperature 1,6 mm (1/16 inch) from case for 60 seconds: JG package	300°C

† Stresses beyond those listed under “absolute maximum ratings” may cause permanent damage to the device. These are stress ratings only, and functional operation of the device at these or any other conditions beyond those indicated under “recommended operating conditions” is not implied. Exposure to absolute-maximum-rated conditions for extended periods may affect device reliability.

- NOTES:
1. All voltage values except differential voltages are with respect to the midpoint between  $V_{DD+}$  and  $V_{DD-}$ .
  2. Differential voltages are at  $IN+$  with respect to  $IN-$ .
  3. The output may be shorted to either supply. Temperature and/or supply voltages must be limited to ensure that the maximum dissipation rating is not exceeded.

**DISSIPATION RATING TABLE**

PACKAGE	$T_A \leq 25^\circ\text{C}$	DERATING FACTOR	$T_A = 70^\circ\text{C}$	$T_A = 85^\circ\text{C}$	$T_A = 125^\circ\text{C}$
	POWER RATING	ABOVE $T_A = 25^\circ\text{C}$	POWER RATING	POWER RATING	POWER RATING
D–8	725 mW	5.8 mW/°C	464 mW	377 mW	145 mW
D–14	950 mW	7.6 mW/°C	608 mW	494 mW	190 mW
PS	770 mW	6.2 mW/°C	496 mW	403 mW	155 mW
FK	1375 mW	11.0 mW/°C	880 mW	715 mW	275 mW
JG	1050 mW	8.4 mW/°C	672 mW	546 mW	210 mW
P	1000 mW	8.0 mW/°C	640 mW	520 mW	200 mW

## recommended operating conditions

	C SUFFIX		I SUFFIX		M SUFFIX		UNIT
	MIN	MAX	MIN	MAX	MIN	MAX	
Supply voltage, $V_{DD\pm}$	±2.3	±8	±2.3	±8	±2.3	±8	V
Common-mode input voltage, $V_{IC}$	$V_{DD-}$	$V_{DD+} - 2.3$	$V_{DD-}$	$V_{DD+} - 2.3$	$V_{DD-}$	$V_{DD+} - 2.3$	V
Operating free-air temperature, $T_A$	0	70	–40	85	–55	125	°C

**TLC220x, TLC220xA, TLC220xB, TLC220xY**  
**Advanced LinCMOS™ LOW-NOISE PRECISION**  
**OPERATIONAL AMPLIFIERS**

SLOS175B – FEBRUARY 1997 – REVISED JANUARY 2008

**TLC2201C electrical characteristics at specified free-air temperature,  $V_{DD\pm} = \pm 5\text{ V}$  (unless otherwise noted)**

PARAMETER	TEST CONDITIONS	$T_A$ †	TLC2201C			UNIT
			MIN	TYP	MAX	
$V_{IO}$ Input offset voltage	$V_{IC} = 0, R_S = 50\ \Omega$	25°C	100	500	$\mu\text{V}$	
		Full range	600			
$\alpha_{V_{IO}}$ Temperature coefficient of input offset voltage		Full range	0.5		$\mu\text{V}/^\circ\text{C}$	
Input offset voltage long-term drift (see Note 4)		25°C	0.001	0.005	$\mu\text{V}/\text{mo}$	
$I_{IO}$ Input offset current		25°C	0.5	60	$\text{pA}$	
		Full range	100			
$I_{IB}$ Input bias current		25°C	1	60	$\text{pA}$	
		Full range	100			
$V_{ICR}$ Common-mode input voltage range	$R_S = 50\ \Omega$	Full range	-5 to 2.7	$\text{V}$		
$V_{OM+}$ Maximum positive peak output voltage swing	$R_L = 10\ \text{k}\Omega$	25°C	4.7	4.8	$\text{V}$	
		Full range	4.7			
$V_{OM-}$ Maximum negative peak output voltage swing		25°C	-4.7	-4.9	$\text{V}$	
		Full range	-4.7			
$A_{VD}$ Large-signal differential voltage amplification	$V_O = \pm 4\ \text{V}, R_L = 500\ \text{k}\Omega$	25°C	400	560	$\text{V}/\text{mV}$	
		Full range	300			
	$V_O = \pm 4\ \text{V}, R_L = 10\ \text{k}\Omega$	25°C	90	100		
		Full range	70			
$\text{CMRR}$ Common-mode rejection ratio	$V_{IC} = V_{ICR\text{min}}, V_O = 0, R_S = 50\ \Omega$	Full range	85		$\text{dB}$	
$k_{SVR}$ Supply voltage rejection ratio ( $\Delta V_{DD\pm} / \Delta V_{IO}$ )	$V_{DD\pm} = \pm 2.3\ \text{V}$ to $\pm 8\ \text{V}$	25°C	90	110	$\text{dB}$	
		Full range	85			
$I_{DD}$ Supply current	$V_O = 0, \text{ No load}$	25°C	1.1	1.5	$\text{mA}$	
		Full range	1.5			

† Full range is 0°C to +70°C.

NOTE 4: Typical values are based on the input offset voltage shift observed through 168 hours of operating life test at  $T_A = 150^\circ\text{C}$  extrapolated to  $T_A = 25^\circ\text{C}$  using the Arrhenius equation and assuming an activation energy of 0.96 eV.

**TLC2201C operating characteristics at specified free-air temperature,  $V_{DD\pm} = \pm 5\ \text{V}$**

PARAMETER	TEST CONDITIONS	$T_A$ †	TLC2201C			UNIT
			MIN	TYP	MAX	
SR Slew rate at unity gain	$V_O = \pm 2.3\ \text{V}, R_L = 10\ \text{k}\Omega, C_L = 100\ \text{pF}$	25°C	2	2.7	$\text{V}/\mu\text{s}$	
		Full range	1.5			
$V_n$ Equivalent input noise voltage	$f = 10\ \text{Hz}$	25°C	18		$\text{nV}/\sqrt{\text{Hz}}$	
	$f = 1\ \text{kHz}$	25°C	8			
$V_{N(\text{PP})}$ Peak-to-peak equivalent input noise voltage	$f = 0.1$ to $1\ \text{Hz}$	25°C	0.5		$\mu\text{V}$	
	$f = 0.1$ to $10\ \text{Hz}$	25°C	0.7			
$I_n$ Equivalent input noise current		25°C	0.6		$\text{fA}/\sqrt{\text{Hz}}$	
Gain-bandwidth product	$f = 10\ \text{kHz}, R_L = 10\ \text{k}\Omega, C_L = 100\ \text{pF}$	25°C	1.9		$\text{MHz}$	
$\phi_m$ Phase margin at unity gain	$R_L = 10\ \text{k}\Omega, C_L = 100\ \text{pF}$	25°C	48°			

† Full range is 0°C to +70°C.



**TLC220x, TLC220xA, TLC220xB, TLC220xY**  
**Advanced LinCMOS™ LOW-NOISE PRECISION**  
**OPERATIONAL AMPLIFIERS**

SLOS175B – FEBRUARY 1997 – REVISED JANUARY 2008

**TLC2201C electrical characteristics at specified free-air temperature,  $V_{DD\pm} = \pm 5\text{ V}$  (unless otherwise noted)**

PARAMETER	TEST CONDITIONS	$T_A$ †	TLC2201AC			TLC2201BC			UNIT
			MIN	TYP	MAX	MIN	TYP	MAX	
$V_{IO}$ Input offset voltage	$V_{IC} = 0, R_S = 50\ \Omega$	25°C	80	200		80	200	$\mu\text{V}$	
		Full range			300		300		
$\alpha_{VIO}$ Temperature coefficient of input offset voltage		Full range	0.5			0.5			$\mu\text{V}/^\circ\text{C}$
Input offset voltage long-term drift (see Note 4)		25°C	0.001	0.005		0.001	0.005	$\mu\text{V}/\text{mo}$	
$I_{IO}$ Input offset current		25°C	0.5	60		0.5	60	$\text{pA}$	
		Full range			100		100		
$I_{IB}$ Input bias current		25°C	1	60		1	60	$\text{pA}$	
		Full range			100		100		
$V_{ICR}$ Common-mode input voltage range		$R_S = 50\ \Omega$	Full range	–5 to 2.7		–5 to 2.7		$\text{V}$	
$V_{OM+}$ Maximum positive peak output voltage swing		$R_L = 10\ \text{k}\Omega$	25°C	4.7	4.8		4.7	4.8	$\text{V}$
$V_{OM-}$ Maximum negative peak output voltage swing	Full range		4.7		4.7				
	25°C		–4.7	–4.9		–4.7	–4.9	$\text{V}$	
Full range	–4.7		–4.7						
$A_{VD}$ Large-signal differential voltage amplification	$V_O = \pm 4\ \text{V}, R_L = 500\ \text{k}\Omega$	25°C	400	560		400	560	$\text{V}/\text{mV}$	
		Full range	300		300				
	$V_O = \pm 4\ \text{V}, R_L = 10\ \text{k}\Omega$	25°C	90	100		90	100		
		Full range	70		70				
CMRR Common-mode rejection ratio	$V_{IC} = V_{ICR\text{min}}, V_O = 0, R_S = 50\ \Omega$	25°C	90	115		90	115	dB	
		Full range	85		85				
$k_{SVR}$ Supply voltage rejection ratio ( $\Delta V_{DD\pm} / \Delta V_{IO}$ )	$V_{DD\pm} = \pm 2.3\ \text{V to } \pm 8\ \text{V}$	25°C	90	110		90	110	dB	
		Full range	85		85				
$I_{DD}$ Supply current	$V_O = 0, \text{ No load}$	25°C	1.1	1.5		1.1	1.5	mA	
		Full range	1.5		1.5				

† Full range is 0°C to +70°C.

NOTE 4: Typical values are based on the input offset voltage shift observed through 168 hours of operating life test at  $T_A = 150^\circ\text{C}$  extrapolated to  $T_A = 25^\circ\text{C}$  using the Arrhenius equation and assuming an activation energy of 0.96 eV.

**TLC220x, TLC220xA, TLC220xB, TLC220xY**  
**Advanced LinCMOS™ LOW-NOISE PRECISION**  
**OPERATIONAL AMPLIFIERS**

SLOS175B – FEBRUARY 1997 – REVISED JANUARY 2008

**TLC2201C operating characteristics at specified free-air temperature,  $V_{DD\pm} = \pm 5\text{ V}$**

PARAMETER	TEST CONDITIONS	$T_A$ †	TLC2201AC			TLC2201BC			UNIT
			MIN	TYP	MAX	MIN	TYP	MAX	
SR Slew rate at unity gain	$V_O = \pm 2.3\text{ V}$ , $R_L = 10\text{ k}\Omega$ , $C_L = 100\text{ pF}$	25°C	2	2.7		2	2.7		V/ $\mu\text{s}$
		Full range	1.5			1.5			
$V_n$ Equivalent input noise voltage (see Note 5)	$f = 10\text{ Hz}$	25°C		18	35		18	30	nV/ $\sqrt{\text{Hz}}$
	$f = 1\text{ kHz}$	25°C		8	15		8	12	
$V_{N(PP)}$ Peak-to-peak equivalent input noise voltage	$f = 0.1\text{ to }1\text{ Hz}$	25°C		0.5			0.5		$\mu\text{V}$
	$f = 0.1\text{ to }10\text{ Hz}$	25°C		0.7			0.7		
$I_n$ Equivalent input noise current		25°C		0.6			0.6	fA/ $\sqrt{\text{Hz}}$	
Gain-bandwidth product	$f = 10\text{ kHz}$ , $R_L = 10\text{ k}\Omega$ , $C_L = 100\text{ pF}$	25°C		1.9			1.9	MHz	
$\phi_m$ Phase margin at unity gain	$R_L = 10\text{ k}\Omega$ , $C_L = 100\text{ pF}$	25°C		48°			48°		

† Full range is 0°C to +70°C.

NOTE 5: This parameter is tested on a sample basis for the TLC2201A and on all devices for the TLC2201B. For other test requirements, please contact the factory. This statement has no bearing on testing or nontesting of other parameters.

**TLC220x, TLC220xA, TLC220xB, TLC220xY**  
**Advanced LinCMOS™ LOW-NOISE PRECISION**  
**OPERATIONAL AMPLIFIERS**

SLOS175B – FEBRUARY 1997 – REVISED JANUARY 2008

**TLC2201C electrical characteristics at specified free-air temperature,  $V_{DD} = 5\text{ V}$  (unless otherwise noted)**

PARAMETER	TEST CONDITIONS	$T_A$ †	TLC2201C			UNIT
			MIN	TYP	MAX	
$V_{IO}$ Input offset voltage	$V_{IC} = 0, \quad R_S = 50\ \Omega$	25°C		100	500	$\mu\text{V}$
		Full range			600	
$\alpha_{V_{IO}}$ Temperature coefficient of input offset voltage		Full range		0.5		$\mu\text{V}/^\circ\text{C}$
Input offset voltage long-term drift (see Note 4)		25°C		0.001	0.005	$\mu\text{V}/\text{mo}$
$I_{IO}$ Input offset current		25°C		0.5	60	$\text{pA}$
		Full range			100	
$I_{IB}$ Input bias current		25°C		1	60	$\text{pA}$
		Full range			100	
$V_{ICR}$ Common-mode input voltage range	$R_S = 50\ \Omega$	Full range	0 to 2.7		V	
$V_{OH}$ Maximum high-level output voltage	$R_L = 10\ \text{k}\Omega$	25°C	4.7	4.8	V	
		Full range	4.7			
$V_{OL}$ Maximum low-level output voltage	$I_O = 0$	25°C		0 50	mV	
		Full range		50		
$A_{VD}$ Large-signal differential voltage amplification	$V_O = 1\text{ V to }4\text{ V}, \quad R_L = 500\ \text{k}\Omega$	25°C	150	315	V/mV	
		Full range	100			
	$V_O = 1\text{ V to }4\text{ V}, \quad R_L = 10\ \text{k}\Omega$	25°C	25	55		
		Full range	15			
CMRR Common-mode rejection ratio	$V_{IC} = V_{ICR\text{min}}, \quad V_O = 0, \quad R_S = 50\ \Omega$	25°C	90	110	dB	
		Full range	85			
$k_{SVR}$ Supply voltage rejection ratio ( $\Delta V_{DD\pm}/\Delta V_{IO}$ )	$V_{DD} = 4.6\text{ V to }16\text{ V}$	25°C	90	110	dB	
		Full range	85			
$I_{DD}$ Supply current	$V_O = 2.5\text{ V}, \quad \text{No load}$	25°C		1 1.5	mA	
		Full range		1.5		

† Full range is 0°C to +70°C.

NOTE 4: Typical values are based on the input offset voltage shift observed through 168 hours of operating life test at  $T_A = 150^\circ\text{C}$  extrapolated to  $T_A = 25^\circ\text{C}$  using the Arrhenius equation and assuming an activation energy of 0.96 eV.

**TLC2201C operating characteristics at specified free-air temperature,  $V_{DD} = 5\text{ V}$**

PARAMETER	TEST CONDITIONS	$T_A$ †	TLC2201C			UNIT
			MIN	TYP	MAX	
SR Slew rate at unity gain	$V_O = 0.5\text{ V to }2.5\text{ V}, \quad R_L = 10\ \text{k}\Omega, \quad C_L = 100\ \text{pF}$	25°C	1.8	2.5	$\text{V}/\mu\text{s}$	
		Full range	1.3			
$V_n$ Equivalent input noise voltage	$f = 10\ \text{Hz}$	25°C		18	$\text{nV}/\sqrt{\text{Hz}}$	
	$f = 1\ \text{kHz}$	25°C		8		
$V_{N(PP)}$ Peak-to-peak equivalent input noise voltage	$f = 0.1\text{ to }1\ \text{Hz}$	25°C		0.5	$\mu\text{V}$	
	$f = 0.1\text{ to }10\ \text{Hz}$	25°C		0.7		
$I_n$ Equivalent input noise current		25°C		0.6	$\text{fA}/\sqrt{\text{Hz}}$	
Gain-bandwidth product	$f = 10\ \text{kHz}, \quad R_L = 10\ \text{k}\Omega, \quad C_L = 100\ \text{pF}$	25°C		1.8	MHz	
$\phi_m$ Phase margin at unity gain	$R_L = 10\ \text{k}\Omega, \quad C_L = 100\ \text{pF}$	25°C		45°		

† Full range is 0°C to +70°C.

**TLC220x, TLC220xA, TLC220xB, TLC220xY**  
**Advanced LinCMOS™ LOW-NOISE PRECISION**  
**OPERATIONAL AMPLIFIERS**

SLOS175B – FEBRUARY 1997 – REVISED JANUARY 2008

**TLC2201C electrical characteristics at specified free-air temperature,  $V_{DD} = 5\text{ V}$  (unless otherwise noted)**

PARAMETER	TEST CONDITIONS	$T_A$ †	TLC2201AC			TLC2201BC			UNIT
			MIN	TYP	MAX	MIN	TYP	MAX	
$V_{IO}$ Input offset voltage	$V_{IC} = 0, R_S = 50\ \Omega$	25°C	80	200		80	200	$\mu\text{V}$	
		Full range		300		300			
$\alpha_{VIO}$ Temperature coefficient of input offset voltage		Full range	0.5			0.5		$\mu\text{V}/^\circ\text{C}$	
Input offset voltage long-term drift (see Note 4)		25°C	0.001	0.005		0.001	0.005	$\mu\text{V}/\text{mo}$	
$I_{IO}$ Input offset current		25°C	0.5	60		0.5	60	$\text{pA}$	
		Full range		100		100			
$I_{IB}$ Input bias current	25°C	1	60		1	60	$\text{pA}$		
	Full range		100		100				
$V_{ICR}$ Common-mode input voltage range	$R_S = 50\ \Omega$	Full range	0 to 2.7			0 to 2.7	$\text{V}$		
$V_{OH}$ Maximum high-level output voltage	$R_L = 10\ \text{k}\Omega$	25°C	4.7	4.8		4.7	4.8	$\text{V}$	
		Full range	4.7			4.7			
$V_{OL}$ Maximum low-level output voltage	$I_O = 0$	25°C		0	50		0	$\text{mV}$	
		Full range			50		50		
$AVD$ Large-signal differential voltage amplification	$V_O = 1\ \text{V to } 4\ \text{V}, R_L = 500\ \text{k}\Omega$	25°C	150	315		150	315	$\text{V}/\text{mV}$	
		Full range	100			100			
	$V_O = 1\ \text{V to } 4\ \text{V}, R_L = 10\ \text{k}\Omega$	25°C	25	55		25	55		
		Full range	15			15			
CMRR Common-mode rejection ratio	$V_{IC} = V_{ICRmin}, V_O = 0, R_S = 50\ \Omega$	25°C	90	110		90	110	$\text{dB}$	
		Full range	85			85			
$k_{SVR}$ Supply voltage rejection ratio ( $\Delta V_{DD} \pm / \Delta V_{IO}$ )	$V_{DD} = 4.6\ \text{V to } 16\ \text{V}$	25°C	90	110		90	110	$\text{dB}$	
		Full range	85			85			
$I_{DD}$ Supply current	$V_O = 2.5\ \text{V}, \text{ No load}$	25°C		1	1.5		1	$\text{mA}$	
		Full range			1.5		1.5		

† Full range is 0°C to +70°C.

NOTE 4: Typical values are based on the input offset voltage shift observed through 168 hours of operating life test at  $T_A = 150^\circ\text{C}$  extrapolated to  $T_A = 25^\circ\text{C}$  using the Arrhenius equation and assuming an activation energy of 0.96 eV.

**TLC220x, TLC220xA, TLC220xB, TLC220xY**  
**Advanced LinCMOS™ LOW-NOISE PRECISION**  
**OPERATIONAL AMPLIFIERS**

SLOS175B – FEBRUARY 1997 – REVISED JANUARY 2008

**TLC2201C operating characteristics at specified free-air temperature,  $V_{DD} = 5\text{ V}$**

PARAMETER	TEST CONDITIONS	$T_A$ †	TLC2201AC			TLC2201BC			UNIT
			MIN	TYP	MAX	MIN	TYP	MAX	
SR Slew rate at unity gain	$V_O = 0.5\text{ V to }2.5\text{ V},$ $R_L = 10\text{ k}\Omega, C_L = 100\text{ pF}$	25°C	1.8	2.5		1.8	2.5		V/ $\mu$ s
		Full range	1.3			1.3			
$V_n$ Equivalent input noise voltage (see Note 5)	$f = 10\text{ Hz}$	25°C		18	35		18	30	nV/ $\sqrt{\text{Hz}}$
	$f = 1\text{ kHz}$	25°C		8	15		8	12	
$V_{N(PP)}$ Peak-to-peak equivalent input noise voltage	$f = 0.1\text{ to }1\text{ Hz}$	25°C		0.5			0.5		$\mu$ V
	$f = 0.1\text{ to }10\text{ Hz}$	25°C		0.7			0.7		
$I_n$ Equivalent input noise current		25°C		0.6			0.6		fA/ $\sqrt{\text{Hz}}$
Gain-bandwidth product	$f = 10\text{ kHz}, R_L = 10\text{ k}\Omega,$ $C_L = 100\text{ pF}$	25°C		1.8			1.8		MHz
$\phi_m$ Phase margin at unity gain	$R_L = 10\text{ k}\Omega, C_L = 100\text{ pF}$	25°C		45°			45°		

† Full range is 0°C to +70°C.

NOTE 5: This parameter is tested on a sample basis for the TLC2201A and on all devices for the TLC2201B. For other test requirements, please contact the factory. This statement has no bearing on testing or nontesting of other parameters.

**TLC220x, TLC220xA, TLC220xB, TLC220xY**  
**Advanced LinCMOS™ LOW-NOISE PRECISION**  
**OPERATIONAL AMPLIFIERS**

SLOS175B – FEBRUARY 1997 – REVISED JANUARY 2008

**TLC2202C electrical characteristics at specified free-air temperature,  $V_{DD\pm} = \pm 5\text{ V}$  (unless otherwise specified)**

PARAMETER	TEST CONDITIONS	$T_A$ †	TLC2202C			UNIT
			MIN	TYP	MAX	
$V_{IO}$ Input offset voltage	$V_{IC} = 0, R_S = 50\ \Omega$	25°C	100	1000	$\mu\text{V}$	
		Full range	1150			
$\alpha_{V_{IO}}$ Temperature coefficient of input offset voltage		Full range	0.5		$\mu\text{V}/^\circ\text{C}$	
Input offset voltage long-term drift (see Note 4)		25°C	0.001	0.005	$\mu\text{V}/\text{mo}$	
$I_{IO}$ Input offset current		25°C	0.5	60	pA	
		Full range	100			
$I_{IB}$ Input bias current	25°C	1	60			
	Full range	100				
$V_{ICR}$ Common-mode input voltage range	$R_S = 50\ \Omega$	Full range	-5 to 2.7		V	
$V_{OM+}$ Maximum positive peak output voltage swing	$R_L = 10\ \text{k}\Omega$	25°C	4.7	4.8	V	
$V_{OM-}$ Maximum negative peak output voltage swing		Full range	4.7			
		25°C	-4.7	-4.9	V	
Full range		-4.7				
$A_{VD}$ Large-signal differential voltage amplification	$V_O = \pm 4\ \text{V}, R_L = 500\ \text{k}\Omega$	25°C	300	560	V/mV	
		Full range	200			
	$V_O = \pm 4\ \text{V}, R_L = 10\ \text{k}\Omega$	25°C	50	100		
		Full range	25			
CMRR Common-mode rejection ratio	$V_O = 0, R_S = 50\ \Omega, V_{IC} = V_{ICRmin}$	25°C	80	115	dB	
		Full range	80			
$k_{SVR}$ Supply-voltage rejection ratio ( $\Delta V_{DD\pm}/\Delta V_{IO}$ )	$V_{DD\pm} = \pm 2.3\ \text{V to } \pm 8\ \text{V}$	25°C	80	110	dB	
		Full range	80			
$I_{DD}$ Supply current	$V_O = 0, \text{ No load}$	25°C	1.8	2.7	mA	
		Full range	2.7			

† Full range is 0°C to +70°C.

NOTE 4: Typical values are based on the input offset voltage shift observed through 168 hours of operating life test at  $T_A = 150^\circ\text{C}$  extrapolated to  $T_A = 25^\circ\text{C}$  using the Arrhenius equation and assuming an activation energy of 0.96 eV.

**TLC2202C operating characteristics at specified free-air temperature,  $V_{DD\pm} = \pm 5\ \text{V}$**

PARAMETER	TEST CONDITIONS	$T_A$ †	TLC2202C			UNIT
			MIN	TYP	MAX	
SR Slew rate at unity gain	$V_O = \pm 2.3\ \text{V}, R_L = 10\ \text{k}\Omega, C_L = 100\ \text{pF}$	25°C	1.8	2.7	$\text{V}/\mu\text{s}$	
		Full range	1.3			
$V_n$ Equivalent input noise voltage	$f = 10\ \text{Hz}$	25°C	18		$\text{nV}/\sqrt{\text{Hz}}$	
	$f = 1\ \text{kHz}$	25°C	8			
$V_{N(PP)}$ Peak-to-peak equivalent input noise voltage	$f = 0.1\ \text{to } 1\ \text{Hz}$	25°C	0.5		$\mu\text{V}$	
	$f = 0.1\ \text{to } 10\ \text{Hz}$	25°C	0.7			
$I_n$ Equivalent input noise current		25°C	0.6		$\text{fA}/\sqrt{\text{Hz}}$	
Gain-bandwidth product	$f = 10\ \text{kHz}, R_L = 10\ \text{k}\Omega, C_L = 100\ \text{pF}$	25°C	1.9		MHz	
$\phi_m$ Phase margin at unity gain	$R_L = 10\ \text{k}\Omega, C_L = 100\ \text{pF}$	25°C	48°			

† Full range is 0°C to +70°C.

# TLC220x, TLC220xA, TLC220xB, TLC220xY Advanced LinCMOS™ LOW-NOISE PRECISION OPERATIONAL AMPLIFIERS

SLOS175B – FEBRUARY 1997 – REVISED JANUARY 2008

**TLC2202C electrical characteristics at specified free-air temperature,  $V_{DD\pm} = \pm 5\text{ V}$  (unless otherwise noted)**

PARAMETER	TEST CONDITIONS	$T_A$ †	TLC2202AC			TLC2202BC			UNIT
			MIN	TYP	MAX	MIN	TYP	MAX	
$V_{IO}$ Input offset voltage		25°C	80	500		80	500	$\mu\text{V}$	
		Full range			650		650		
$\alpha_{VIO}$ Temperature coefficient of input offset voltage	$V_{IC} = 0, R_S = 50\ \Omega$	Full range	0.5			0.5			$\mu\text{V}/^\circ\text{C}$
Input offset voltage long-term drift (see Note 4)		25°C	0.001	0.005		0.001	0.005	$\mu\text{V}/\text{mo}$	
		Full range							
$I_{IO}$ Input offset current		25°C	0.5	60		0.5	60	pA	
		Full range	100			100			
$I_{IB}$ Input bias current		25°C	1	60		1	60	pA	
	Full range	100			100				
$V_{ICR}$ Common-mode input voltage range	$R_S = 50\ \Omega$	Full range	-5 to 2.7			-5 to 2.7			V
$V_{OM+}$ Maximum positive peak output voltage swing	$R_L = 10\ \text{k}\Omega$	25°C	4.7	4.8		4.7	4.8	V	
		Full range	4.7			4.7			
$V_{OM-}$ Maximum negative peak output voltage swing		25°C	-4.7	-4.9		-4.7	-4.9	V	
		Full range	-4.7			-4.7			
$A_{VD}$ Large-signal differential voltage amplification	$V_O = \pm 4\text{ V}, R_L = 500\ \text{k}\Omega$	25°C	300	560		300	560	V/mV	
		Full range	200			200			
	$V_O = \pm 4\text{ V}, R_L = 10\ \text{k}\Omega$	25°C	50	100		50	100		
		Full range	25			25			
CMRR Common-mode rejection ratio	$V_{IC} = V_{ICR\text{min}}, V_O = 0, R_S = 50\ \Omega$	25°C	80	115		80	115	dB	
		Full range	80			80			
$k_{SVR}$ Supply-voltage rejection ratio ( $\Delta V_{DD\pm}/\Delta V_{IO}$ )	$V_{DD\pm} = \pm 2.3\text{ V to } \pm 8\text{ V}$	25°C	80	110		80	110	dB	
		Full range	80			80			
$I_{DD}$ Supply current	$V_O = 0, \text{ No load}$	25°C	1.8	2.7		1.8	2.7	mA	
		Full range	2.7			2.7			

† Full range is 0°C to +70°C.

NOTE 4: Typical values are based on the input offset voltage shift observed through 168 hours of operating life test at  $T_A = 150^\circ\text{C}$  extrapolated to  $T_A = 25^\circ\text{C}$  using the Arrhenius equation and assuming an activation energy of 0.96 eV.

**TLC2202C operating characteristics at specified free-air temperature,  $V_{DD\pm} = \pm 5\text{ V}$**

PARAMETER	TEST CONDITIONS	$T_A$ †	TLC2202AC			TLC2202BC			UNIT
			MIN	TYP	MAX	MIN	TYP	MAX	
SR Slew rate at unity gain	$V_O = \pm 2.3\text{ V}, R_L = 10\ \text{k}\Omega, C_L = 100\ \text{pF}$	25°C	1.8	2.7		1.8	2.7	V/ $\mu\text{s}$	
		Full range	1.3			1.3			
$V_n$ Equivalent input noise voltage (see Note 5)	$f = 10\ \text{Hz}$	25°C	18	35		18	30	nV/ $\sqrt{\text{Hz}}$	
	$f = 1\ \text{kHz}$	25°C	8	15		8	12		
$V_{N(PP)}$ Peak-to-peak equivalent input noise voltage	$f = 0.1\ \text{to } 1\ \text{Hz}$	25°C	0.5			0.5			$\mu\text{V}$
	$f = 0.1\ \text{to } 10\ \text{Hz}$	25°C	0.7			0.7			
$I_n$ Equivalent input noise current		25°C	0.6			0.6			fA/ $\sqrt{\text{Hz}}$
Gain-bandwidth product	$f = 10\ \text{kHz}, R_L = 10\ \text{k}\Omega, C_L = 100\ \text{pF}$	25°C	1.9			1.9			MHz
$\phi_m$ Phase margin at unity gain	$R_I = 10\ \text{k}\Omega, C_I = 100\ \text{pF}$	25°C	48°			48°			

† Full range is 0°C to +70°C.

NOTE 5: This parameter is tested on a sample basis for the TLC2202A and on all devices for the TLC2202B. For other test requirements, please contact the factory. This statement has no bearing on testing or nontesting of other parameters.

**TLC220x, TLC220xA, TLC220xB, TLC220xY**  
**Advanced LinCMOS™ LOW-NOISE PRECISION**  
**OPERATIONAL AMPLIFIERS**

SLOS175B – FEBRUARY 1997 – REVISED JANUARY 2008

**TLC2202C electrical characteristics at specified free-air temperature,  $V_{DD} = 5\text{ V}$  (unless otherwise noted)**

PARAMETER	TEST CONDITIONS	$T_A$ †	TLC2202C			UNIT
			MIN	TYP	MAX	
$V_{IO}$ Input offset voltage	$V_{IC} = 0, R_S = 50\ \Omega$	25°C	100	1000		$\mu\text{V}$
		Full range		1150		
$\alpha_{V_{IO}}$ Temperature coefficient of input offset voltage		Full range	0.5			$\mu\text{V}/^\circ\text{C}$
Input offset voltage long-term drift (see Note 4)		25°C	0.001	0.005		$\mu\text{V}/\text{mo}$
		25°C	0.5	60		$\text{pA}$
$I_{IO}$ Input offset current		Full range		100		
$I_{IB}$ Input bias current	25°C	1	60		$\text{pA}$	
	Full range		100			
$V_{ICR}$ Common-mode input voltage range	$R_S = 50\ \Omega$	Full range	0 to 2.7		V	
$V_{OH}$ Maximum high-level output voltage	$R_L = 10\ \text{k}\Omega$	25°C	4.7	4.8		V
		Full range	4.7			
$V_{OL}$ Maximum low-level output voltage	$I_O = 0$	25°C	0	50		mV
		Full range		50		
$A_{VD}$ Large-signal differential voltage amplification	$V_O = 1\text{ V to }4\text{ V}, R_L = 500\ \text{k}\Omega$	25°C	150	315		V/mV
		Full range	100			
	$V_O = 1\text{ V to }4\text{ V}, R_L = 10\ \text{k}\Omega$	25°C	25	55		
		Full range	15			
CMRR Common-mode rejection ratio	$V_O = 0, R_S = 50\ \Omega, V_{IC} = V_{ICRmin}$	25°C	75	110		dB
		Full range	75			
$k_{SVR}$ Supply-voltage rejection ratio ( $\Delta V_{DD\pm}/\Delta V_{IO}$ )	$V_{DD} = 4.6\text{ V to }16\text{ V}$	25°C	80	110		dB
		Full range	80			
$I_{DD}$ Supply current	$V_O = 0, \text{ No load}$	25°C	1.7	2.6		mA
		Full range		2.6		

† Full range is 0°C to +70°C.

NOTE 4: Typical values are based on the input offset voltage shift observed through 168 hours of operating life test at  $T_A = 150^\circ\text{C}$  extrapolated to  $T_A = 25^\circ\text{C}$  using Arrhenius equation and assuming an activation energy of 0.96 eV.

**TLC2202C operating characteristics at specified free-air temperature,  $V_{DD} = 5\text{ V}$**

PARAMETER	TEST CONDITIONS	$T_A$ †	TLC2202C			UNIT
			MIN	TYP	MAX	
SR Slew rate at unity gain	$V_O = 0.5\text{ V to }2.5\text{ V}, R_L = 10\ \text{k}\Omega, C_L = 100\ \text{pF}$	25°C	1.6	2.5		$\text{V}/\mu\text{s}$
		Full range	1.1			
$V_n$ Equivalent input noise voltage	$f = 10\ \text{Hz}$	25°C		18		$\text{nV}/\sqrt{\text{Hz}}$
	$f = 1\ \text{kHz}$	25°C		8		
$V_{N(PP)}$ Peak-to-peak equivalent input noise voltage	$f = 0.1\text{ to }1\ \text{Hz}$	25°C		0.5		$\mu\text{V}$
	$f = 0.1\text{ to }10\ \text{Hz}$	25°C		0.7		
$I_n$ Equivalent input noise current		25°C		0.6		$\text{fA}/\sqrt{\text{Hz}}$
Gain-bandwidth product	$f = 10\ \text{kHz}, R_L = 10\ \text{k}\Omega, C_L = 100\ \text{pF}$	25°C		1.9		MHz
$\phi_m$ Phase margin at unity gain	$R_L = 10\ \text{k}\Omega, C_L = 100\ \text{pF}$	25°C		47°		

† Full range is 0°C to +70°C.



# TLC220x, TLC220xA, TLC220xB, TLC220xY Advanced LinCMOS™ LOW-NOISE PRECISION OPERATIONAL AMPLIFIERS

SLOS175B – FEBRUARY 1997 – REVISED JANUARY 2008

**TLC2202C electrical characteristics at specified free-air temperature,  $V_{DD} = 5\text{ V}$  (unless otherwise noted)**

PARAMETER	TEST CONDITIONS	$T_A$ †	TLC2202AC			TLC2202BC			UNIT
			MIN	TYP	MAX	MIN	TYP	MAX	
$V_{IO}$ Input offset voltage	$V_{IC} = 0, R_S = 50\ \Omega$	25°C	80	500	80	500	$\mu\text{V}$		
		Full range	650		650				
$\alpha_{VIO}$ Temperature coefficient of input offset voltage		Full range	0.5		0.5		$\mu\text{V}/^\circ\text{C}$		
Input offset voltage long-term drift (see Note 4)		25°C	0.001	0.005	0.001	0.005	$\mu\text{V}/\text{mo}$		
$I_{IO}$ Input offset current		25°C	0.5	60	0.5	60	$\text{pA}$		
		Full range	100		100				
$I_{IB}$ Input bias current		25°C	1	60	1	60	$\text{pA}$		
		Full range	100		100				
$V_{ICR}$ Common-mode input voltage range	$R_S = 50\ \Omega$	Full range	0 to 2.7	0 to 2.7	0 to 2.7	0 to 2.7	V		
$V_{OH}$ Maximum high-level output voltage	$R_L = 10\ \text{k}\Omega$	25°C	4.7	4.8	4.7	4.8	V		
		Full range	4.7		4.7				
$V_{OL}$ Maximum low-level output voltage	$I_O = 0$	25°C	0	50	0	50	mV		
		Full range	50		50				
$A_{VD}$ Large-signal differential voltage amplification	$V_O = 1\text{ V to }4\text{ V}, R_L = 500\ \text{k}\Omega$	25°C	150	315	150	315	V/mV		
		Full range	100		100				
	$V_O = 1\text{ V to }4\text{ V}, R_L = 10\ \text{k}\Omega$	25°C	25	55	25	55			
		Full range	15		15				
CMRR Common-mode rejection ratio	$V_{IC} = V_{ICR\text{min}}, V_O = 0, R_S = 50\ \Omega$	25°C	75	110	75	110	dB		
		Full range	75		75				
$k_{SVR}$ Supply-voltage rejection ratio ( $\Delta V_{DD\pm}/\Delta V_{IO}$ )	$V_{DD} = 4.6\text{ V to }16\text{ V}$	25°C	80	110	80	110	dB		
		Full range	80		80				
$I_{DD}$ Supply current	$V_O = 2.5\text{ V}, \text{ No load}$	25°C	1.7	2.6	1.7	2.6	mA		
		Full range	2.6		2.6				

† Full range is 0°C to +70°C.

NOTE 4: Typical values are based on the input offset voltage shift observed through 168 hours of operating life test at  $T_A = 150^\circ\text{C}$  extrapolated to  $T_A = 25^\circ\text{C}$  using the Arrhenius equation and assuming an activation energy of 0.96 eV.

**TLC2202C operating characteristics at specified free-air temperature,  $V_{DD} = 5\text{ V}$**

PARAMETER	TEST CONDITIONS	$T_A$ †	TLC2202AC			TLC2202BC			UNIT
			MIN	TYP	MAX	MIN	TYP	MAX	
SR Slew rate at unity gain	$V_O = 0.5\text{ V to }2.5\text{ V}, R_L = 10\ \text{k}\Omega, C_L = 100\ \text{pF}$	25°C	1.6	2.5	1.6	2.5	$\text{V}/\mu\text{s}$		
		Full range	1.1		1.1				
$V_n$ Equivalent input noise voltage (see Note 5)	$f = 10\ \text{Hz}$	25°C	18	35	18	30	$\text{nV}/\sqrt{\text{Hz}}$		
	$f = 1\ \text{kHz}$	25°C	8	15	8	12			
$V_{N(PP)}$ Peak-to-peak equivalent input noise voltage	$f = 0.1\text{ to }1\ \text{Hz}$	25°C	0.5		0.5		$\mu\text{V}$		
	$f = 0.1\text{ to }10\ \text{Hz}$	25°C	0.7		0.7				
$I_n$ Equivalent input noise current		25°C	0.6		0.6		$\text{fA}/\sqrt{\text{Hz}}$		
Gain-bandwidth product	$f = 10\ \text{kHz}, R_L = 10\ \text{k}\Omega, C_L = 100\ \text{pF}$	25°C	1.9		1.9		MHz		
$\phi_m$ Phase margin at unity gain	$R_l = 10\ \text{k}\Omega, C_l = 100\ \text{pF}$	25°C	47°		47°				

† Full range is 0°C to +70°C.

NOTE 5: This parameter is tested on a sample basis for the TLC2202A and on all devices for the TLC2202B. For other test requirements, please contact the factory. This statement has no bearing on testing or nontesting of other parameters.

**TLC220x, TLC220xA, TLC220xB, TLC220xY**  
**Advanced LinCMOS™ LOW-NOISE PRECISION**  
**OPERATIONAL AMPLIFIERS**

SLOS175B – FEBRUARY 1997 – REVISED JANUARY 2008

**TLC2201I electrical characteristics at specified free-air temperature,  $V_{DD\pm} = \pm 5\text{ V}$  (unless otherwise noted)**

PARAMETER	TEST CONDITIONS	$T_A$ †	TLC2201I			UNIT
			MIN	TYP	MAX	
$V_{IO}$ Input offset voltage	$V_{IC} = 0, R_S = 50\ \Omega$	25°C	100	500	$\mu\text{V}$	
		Full range	650			
$\alpha_{V_{IO}}$ Temperature coefficient of input offset voltage		Full range	0.5		$\mu\text{V}/^\circ\text{C}$	
Input offset voltage long-term drift (see Note 4)		25°C	0.001	0.005	$\mu\text{V}/\text{mo}$	
$I_{IO}$ Input offset current		25°C	0.5	60	$\text{pA}$	
		Full range	150			
$I_{IB}$ Input bias current		25°C	1	60	$\text{pA}$	
		Full range	150			
$V_{ICR}$ Common-mode input voltage range	$R_S = 50\ \Omega$	Full range	-5 to 2.7	$\text{V}$		
$V_{OM+}$ Maximum positive peak output voltage swing	$R_L = 10\ \text{k}\Omega$	25°C	4.7	4.8	$\text{V}$	
$V_{OM-}$ Maximum negative peak output voltage swing		Full range	4.7			
		25°C	-4.7	-4.9	$\text{V}$	
Full range		-4.7				
$A_{VD}$ Large-signal differential voltage amplification	$V_O = \pm 4\ \text{V}, R_L = 500\ \text{k}\Omega$	25°C	400	560	$\text{V}/\text{mV}$	
		Full range	250			
	$V_O = \pm 4\ \text{V}, R_L = 10\ \text{k}\Omega$	25°C	90	100		
		Full range	65			
CMRR Common-mode rejection ratio	$V_{IC} = V_{ICR\text{min}}, V_O = 0, R_S = 50\ \Omega$	25°C	90	115	$\text{dB}$	
		Full range	85			
$k_{SVR}$ Supply voltage rejection ratio ( $\Delta V_{DD\pm}/\Delta V_{IO}$ )	$V_{DD\pm} = \pm 2.3\ \text{V to } \pm 8\ \text{V}$	25°C	90	110	$\text{dB}$	
		Full range	85			
$I_{DD}$ Supply current	$V_O = 0, \text{ No load}$	25°C	1.1	1.5	$\text{mA}$	
		Full range	1.5			

† Full range is  $-40^\circ\text{C}$  to  $+85^\circ\text{C}$ .

NOTE 4: Typical values are based on the input offset voltage shift observed through 168 hours of operating life test at  $T_A = 150^\circ\text{C}$  extrapolated to  $T_A = 25^\circ\text{C}$  using the Arrhenius equation and assuming an activation energy of 0.96 eV.

**TLC2201I operating characteristics at specified free-air temperature,  $V_{DD\pm} = \pm 5\ \text{V}$**

PARAMETER	TEST CONDITIONS	$T_A$ †	TLC2201I			UNIT
			MIN	TYP	MAX	
SR Slew rate at unity gain	$V_O = \pm 2.3\ \text{V}, R_L = 10\ \text{k}\Omega, C_L = 100\ \text{pF}$	25°C	2	2.7	$\text{V}/\mu\text{s}$	
		Full range	1.4			
$V_n$ Equivalent input noise voltage	$f = 10\ \text{Hz}$	25°C	18		$\text{nV}/\sqrt{\text{Hz}}$	
	$f = 1\ \text{kHz}$	25°C	8			
$V_{N(PP)}$ Peak-to-peak equivalent input noise voltage	$f = 0.1\ \text{to } 1\ \text{Hz}$	25°C	0.5		$\mu\text{V}$	
	$f = 0.1\ \text{to } 10\ \text{Hz}$	25°C	0.7			
$I_n$ Equivalent input noise current		25°C	0.6		$\text{fA}/\sqrt{\text{Hz}}$	
Gain-bandwidth product	$f = 10\ \text{kHz}, R_L = 10\ \text{k}\Omega, C_L = 100\ \text{pF}$	25°C	1.9		$\text{MHz}$	
$\phi_m$ Phase margin at unity gain	$R_L = 10\ \text{k}\Omega, C_L = 100\ \text{pF}$	25°C	48°			

† Full range is  $-40^\circ\text{C}$  to  $+85^\circ\text{C}$ .

**TLC220x, TLC220xA, TLC220xB, TLC220xY**  
**Advanced LinCMOS™ LOW-NOISE PRECISION**  
**OPERATIONAL AMPLIFIERS**

SLOS175B – FEBRUARY 1997 – REVISED JANUARY 2008

**TLC2201I electrical characteristics at specified free-air temperature,  $V_{DD\pm} = \pm 5\text{ V}$  (unless otherwise noted)**

PARAMETER	TEST CONDITIONS	$T_A$ †	TLC2201AI			TLC2201BI			UNIT
			MIN	TYP	MAX	MIN	TYP	MAX	
$V_{IO}$ Input offset voltage	$V_{IC} = 0, R_S = 50\ \Omega$	25°C	80	200		80	200	$\mu\text{V}$	
		Full range			350		350		
$\alpha_{VIO}$ Temperature coefficient of input offset voltage		Full range	0.5			0.5		$\mu\text{V}/^\circ\text{C}$	
Input offset voltage long-term drift (see Note 4)		25°C	0.001	0.005		0.001	0.005	$\mu\text{V}/\text{mo}$	
$I_{IO}$ Input offset current		25°C	0.5	60		0.5	60	$\text{pA}$	
		Full range			150		150		
$I_{IB}$ Input bias current		25°C	1	60		1	60	$\text{pA}$	
		Full range			150		150		
$V_{ICR}$ Common-mode input voltage range	$R_S = 50\ \Omega$	Full range	–5 to 2.7		–5 to 2.7		$\text{V}$		
$V_{OM+}$ Maximum positive peak output voltage swing	$R_L = 10\ \text{k}\Omega$	25°C	4.7	4.8		4.7	4.8	$\text{V}$	
		Full range	4.7			4.7			
$V_{OM-}$ Maximum negative peak output voltage swing		25°C	–4.7	–4.9		–4.7	–4.9	$\text{V}$	
		Full range	–4.7			–4.7			
$A_{VD}$ Large-signal differential voltage amplification	$V_O = \pm 4\ \text{V}, R_L = 500\ \text{k}\Omega$	25°C	400	560		400	560	$\text{V}/\text{mV}$	
		Full range	250			250			
	$V_O = \pm 4\ \text{V}, R_L = 10\ \text{k}\Omega$	25°C	90	100		90	100		
		Full range	65			65			
CMRR Common-mode rejection ratio	$V_{IC} = V_{ICRmin}, V_O = 0, R_S = 50\ \Omega$	25°C	90	115		90	115	dB	
		Full range	85			85			
$k_{SVR}$ Supply voltage rejection ratio ( $\Delta V_{DD\pm}/\Delta V_{IO}$ )	$V_{DD\pm} = \pm 2.3\ \text{V}$ to $\pm 8\ \text{V}$	25°C	90	110		90	110	dB	
		Full range	85			85			
$I_{DD}$ Supply current	$V_O = 0, \text{ No load}$	25°C		1.1	1.5		1.1	1.5	mA
		Full range			1.5			1.5	

† Full range is  $-40^\circ\text{C}$  to  $+85^\circ\text{C}$ .

NOTE 4: Typical values are based on the input offset voltage shift observed through 168 hours of operating life test at  $T_A = 150^\circ\text{C}$  extrapolated to  $T_A = 25^\circ\text{C}$  using the Arrhenius equation assuming an activation energy of 0.96 eV.

**TLC220x, TLC220xA, TLC220xB, TLC220xY**  
**Advanced LinCMOS™ LOW-NOISE PRECISION**  
**OPERATIONAL AMPLIFIERS**

SLOS175B – FEBRUARY 1997 – REVISED JANUARY 2008

**TLC2201I operating characteristics at specified free-air temperature,  $V_{DD\pm} = \pm 5\text{ V}$**

PARAMETER	TEST CONDITIONS	$T_A$ †	TLC2201AI			TLC2201BI			UNIT
			MIN	TYP	MAX	MIN	TYP	MAX	
SR Slew rate at unity gain	$V_O = \pm 2.3\text{ V}$ , $R_L = 10\text{ k}\Omega$ , $C_L = 100\text{ pF}$	25°C	2	2.7		2	2.7		V/ $\mu$ s
		Full range	1.4			1.4			
$V_n$ Equivalent input noise voltage (see Note 5)	$f = 10\text{ Hz}$	25°C		18	35		18	30	nV/ $\sqrt{\text{Hz}}$
	$f = 1\text{ kHz}$	25°C		8	15		8	12	
$V_{N(PP)}$ Peak-to-peak equivalent input noise voltage	$f = 0.1\text{ to }1\text{ Hz}$	25°C		0.5			0.5		$\mu$ V
	$f = 0.1\text{ to }10\text{ Hz}$	25°C		0.7			0.7		
$I_n$ Equivalent input noise current		25°C		0.6			0.6		fA/ $\sqrt{\text{Hz}}$
Gain-bandwidth product	$f = 10\text{ kHz}$ , $R_L = 10\text{ k}\Omega$ , $C_L = 100\text{ pF}$	25°C		1.9			1.9		MHz
$\phi_m$ Phase margin at unity gain	$R_L = 10\text{ k}\Omega$ , $C_L = 100\text{ pF}$	25°C		48°			48°		

† Full range is  $-40^\circ\text{C}$  to  $+85^\circ\text{C}$ .

NOTE 5: This parameter is tested on a sample basis for the TLC2201A and on all devices for the TLC2201B. For other test requirements, please contact the factory. This statement has no bearing on testing or nontesting of other parameters.

# TLC220x, TLC220xA, TLC220xB, TLC220xY Advanced LinCMOS™ LOW-NOISE PRECISION OPERATIONAL AMPLIFIERS

SLOS175B – FEBRUARY 1997 – REVISED JANUARY 2008

**TLC22011 electrical characteristics at specified free-air temperature,  $V_{DD} = 5\text{ V}$  (unless otherwise noted)**

PARAMETER	TEST CONDITIONS	$T_A^\dagger$	TLC22011			UNIT
			MIN	TYP	MAX	
$V_{IO}$ Input offset voltage	$V_{IC} = 0, \quad R_S = 50\ \Omega$	25°C		100	500	$\mu\text{V}$
		Full range			650	
$\alpha_{V_{IO}}$ Temperature coefficient of input offset voltage		Full range		0.5		$\mu\text{V}/^\circ\text{C}$
Input offset voltage long-term drift (see Note 4)		25°C		0.001	0.005	$\mu\text{V}/\text{mo}$
$I_{IO}$ Input offset current		25°C		0.5	60	$\text{pA}$
		Full range			150	
$I_{IB}$ Input bias current		25°C		1	60	$\text{pA}$
		Full range			150	
$V_{ICR}$ Common-mode input voltage range	$R_S = 50\ \Omega$	Full range	0 to 2.7		V	
$V_{OH}$ Maximum high-level output voltage	$R_L = 10\ \text{k}\Omega$	25°C	4.7	4.8	V	
		Full range	4.7			
$V_{OL}$ Maximum low-level output voltage	$I_O = 0$	25°C		0 50	mV	
		Full range		50		
$A_{VD}$ Large-signal differential voltage amplification	$V_O = 1\text{ V to }4\text{ V},$ $R_L = 500\ \text{k}\Omega$	25°C	150	315	V/mV	
		Full range	100			
		25°C	25	55		
		Full range	15			
CMRR Common-mode rejection ratio	$V_{IC} = V_{ICR\text{min}},$ $V_O = 0, \quad R_S = 50\ \Omega$	25°C	90	110	dB	
		Full range	85			
$k_{SVR}$ Supply voltage rejection ratio ( $\Delta V_{DD\pm} / \Delta V_{IO}$ )	$V_{DD} = 4.6\text{ V to }16\text{ V}$	25°C	90	110	dB	
		Full range	85			
$I_{DD}$ Supply current	$V_O = 2.5\text{ V}, \quad \text{No load}$	25°C		1 1.5	mA	
		Full range		1.5		

$^\dagger$  Full range is  $-40^\circ\text{C}$  to  $+85^\circ\text{C}$ .

NOTE 4: Typical values are based on the input offset voltage shift observed through 168 hours of operating life test at  $T_A = 150^\circ\text{C}$  extrapolated to  $T_A = 25^\circ\text{C}$  using the Arrhenius equation and assuming an activation energy of 0.96 eV.

**TLC22011 operating characteristics at specified free-air temperature,  $V_{DD} = 5\text{ V}$**

PARAMETER	TEST CONDITIONS	$T_A^\dagger$	TLC22011			UNIT
			MIN	TYP	MAX	
SR Slew rate at unity gain	$V_O = 0.5\text{ V to }2.5\text{ V},$ $R_L = 10\ \text{k}\Omega, \quad C_L = 100\ \text{pF}$	25°C	1.8	2.5	$\text{V}/\mu\text{s}$	
		Full range	1.2			
$V_n$ Equivalent input noise voltage	$f = 10\ \text{Hz}$	25°C		18	$\text{nV}/\sqrt{\text{Hz}}$	
	$f = 1\ \text{kHz}$	25°C		8		
$V_{N(PP)}$ Peak-to-peak equivalent input noise voltage	$f = 0.1\text{ to }1\ \text{Hz}$	25°C		0.5	$\mu\text{V}$	
	$f = 0.1\text{ to }10\ \text{Hz}$	25°C		0.7		
$I_n$ Equivalent input noise current		25°C		0.6	$\text{fA}/\sqrt{\text{Hz}}$	
Gain-bandwidth product	$f = 10\ \text{kHz}, \quad R_L = 10\ \text{k}\Omega,$ $C_L = 100\ \text{pF}$	25°C		1.8	MHz	
$\phi_m$ Phase margin at unity gain	$R_L = 10\ \text{k}\Omega, \quad C_L = 100\ \text{pF}$	25°C		45°		

$^\dagger$  Full range is  $-40^\circ\text{C}$  to  $+85^\circ\text{C}$ .

**TLC220x, TLC220xA, TLC220xB, TLC220xY**  
**Advanced LinCMOS™ LOW-NOISE PRECISION**  
**OPERATIONAL AMPLIFIERS**

SLOS175B – FEBRUARY 1997 – REVISED JANUARY 2008

**TLC2201I electrical characteristics at specified free-air temperature,  $V_{DD} = 5\text{ V}$  (unless otherwise noted)**

PARAMETER	TEST CONDITIONS	$T_A$ †	TLC2201AI			TLC2201BI			UNIT
			MIN	TYP	MAX	MIN	TYP	MAX	
$V_{IO}$ Input offset voltage	$V_{IC} = 0, R_S = 50\ \Omega$	25°C	80	200		80	200	$\mu\text{A}$	
		Full range		350		350			
$\alpha_{VIO}$ Temperature coefficient of input offset voltage		Full range	0.5			0.5		$\mu\text{V}/^\circ\text{C}$	
Input offset voltage long-term drift (see Note 4)		25°C	0.001	0.005		0.001	0.005	$\mu\text{V}/\text{mo}$	
$I_{IO}$ Input offset current		25°C	0.5	60		0.5	60	$\text{pA}$	
		Full range		150		150			
$I_{IB}$ Input bias current	25°C	1	60		1	60	$\text{pA}$		
	Full range		150		150				
$V_{ICR}$ Common-mode input voltage range	$R_S = 50\ \Omega$	Full range	0 to 2.7			0 to 2.7	V		
$V_{OH}$ Maximum high-level output voltage	$R_L = 10\ \text{k}\Omega$	25°C	4.7	4.8		4.7	4.8	V	
		Full range	4.7			4.7			
$V_{OL}$ Maximum low-level output voltage	$I_O = 0$	25°C		0	50		0	mV	
		Full range		50		50			
$A_{VD}$ Large-signal differential voltage amplification	$V_O = 1\ \text{V to } 4\ \text{V}, R_L = 500\ \text{k}\Omega$	25°C	150	315		150	315	V/mV	
		Full range	100			100			
	$V_O = 1\ \text{V to } 4\ \text{V}, R_L = 10\ \text{k}\Omega$	25°C	25	55		25	55		
		Full range	15			15			
CMRR Common-mode rejection ratio	$V_{IC} = V_{ICR\text{min}}, V_O = 0, R_S = 50\ \Omega$	25°C	90	110		90	110	dB	
		Full range	85			85			
$k_{SVR}$ Supply voltage rejection ratio ( $\Delta V_{DD\pm} / \Delta V_{IO}$ )	$V_{DD} = 4.6\ \text{V to } 16\ \text{V}$	25°C	90	110		90	110	dB	
		Full range	85			85			
$I_{DD}$ Supply current	$V_O = 2.5\ \text{V}, \text{ No load}$	25°C		1	1.5		1	mA	
		Full range			1.5		1.5		

† Full range is  $-40^\circ\text{C}$  to  $+85^\circ\text{C}$ .

NOTE 4: Typical values are based on the input offset voltage shift observed through 168 hours of operating life test at  $T_A = 150^\circ\text{C}$  extrapolated to  $T_A = 25^\circ\text{C}$  using the Arrhenius equation and assuming an activation energy of 0.96 eV.

**TLC220x, TLC220xA, TLC220xB, TLC220xY**  
**Advanced LinCMOS™ LOW-NOISE PRECISION**  
**OPERATIONAL AMPLIFIERS**

SLOS175B – FEBRUARY 1997 – REVISED JANUARY 2008

**TLC2201I operating characteristics at specified free-air temperature,  $V_{DD} = 5\text{ V}$**

PARAMETER	TEST CONDITIONS	$T_A$ †	TLC2201AI			TLC2201BI			UNIT
			MIN	TYP	MAX	MIN	TYP	MAX	
SR Slew rate at unity gain	$V_O = 0.5\text{ V to }2.5\text{ V},$ $R_L = 10\text{ k}\Omega, C_L = 100\text{ pF}$	25°C	1.8	2.5		1.8	2.5		V/ $\mu$ s
		Full range	1.2			1.2			
$V_n$ Equivalent input noise voltage (see Note 5)	$f = 10\text{ Hz}$	25°C		18	35		18	30	nV/ $\sqrt{\text{Hz}}$
	$f = 1\text{ kHz}$	25°C		8	15		8	12	
$V_{N(PP)}$ Peak-to-peak equivalent input noise voltage	$f = 0.1\text{ to }1\text{ Hz}$	25°C		0.5			0.5		$\mu$ V
	$f = 0.1\text{ to }10\text{ Hz}$	25°C		0.7			0.7		
$I_n$ Equivalent input noise current		25°C		0.6			0.6		fA/ $\sqrt{\text{Hz}}$
Gain-bandwidth product	$f = 10\text{ kHz}, R_L = 10\text{ k}\Omega,$ $C_L = 100\text{ pF}$	25°C		1.8			1.8		MHz
$\phi_m$ Phase margin at unity gain	$R_L = 10\text{ k}\Omega, C_L = 100\text{ pF}$	25°C		45°			45°		

† Full range is  $-40^\circ\text{C}$  to  $+85^\circ\text{C}$ .

NOTE 5: This parameter is tested on a sample basis for the TLC2201A and on all devices for the TLC2201B. For other test requirements, please contact the factory. This statement has no bearing on testing or nontesting of other parameters.

**TLC220x, TLC220xA, TLC220xB, TLC220xY**  
**Advanced LinCMOS™ LOW-NOISE PRECISION**  
**OPERATIONAL AMPLIFIERS**

SLOS175B – FEBRUARY 1997 – REVISED JANUARY 2008

**TLC2202I electrical characteristics at specified free-air temperature,  $V_{DD} \pm = \pm 5$  V (unless otherwise noted)**

PARAMETER	TEST CONDITIONS	$T_A \dagger$	TLC2202I			UNIT
			MIN	TYP	MAX	
$V_{IO}$ Input offset voltage	$V_{IC} = 0, R_S = 50 \Omega$	25°C	100	1000	$\mu V$	
		Full range	1200			
$\alpha_{V_{IO}}$ Temperature coefficient of input offset voltage		Full range	0.5	$\mu V/^\circ C$		
Input offset voltage long-term drift (see Note 4)		25°C	0.001	0.005	$\mu V/mo$	
$I_{IO}$ Input offset current		25°C	0.5	60	$pA$	
		Full range	150			
$I_{IB}$ Input bias current		25°C	1	60	$pA$	
		Full range	150			
$V_{ICR}$ Common-mode input voltage range		$R_S = 50 \Omega$	Full range	-5 to 2.7	V	
$V_{OM+}$ Maximum positive peak output voltage swing		$R_L = 10 k\Omega$	25°C	4.7	4.8	V
$V_{OM-}$ Maximum negative peak output voltage swing	Full range		4.7			
	25°C		-4.7	-4.9	V	
Full range	-4.7					
$A_{VD}$ Large-signal differential voltage amplification	$V_O = \pm 4 V, R_L = 500 k\Omega$	25°C	300	560	V/mV	
		Full range	150			
	$V_O = \pm 4 V, R_L = 10 k\Omega$	25°C	50	100		
		Full range	25			
CMRR Common-mode rejection ratio	$V_O = 0, V_{IC} = V_{ICRmin}, R_S = 50 \Omega$	25°C	80	115	dB	
		Full range	80			
$k_{SVR}$ Supply-voltage rejection ratio ( $\Delta V_{DD} / \Delta V_{IO}$ )	$V_{DD} = \pm 2.3 V$ to $\pm 8 V$	25°C	80	110	dB	
		Full range	80			
$I_{DD}$ Supply current	$V_O = 0, \text{ No load}$	25°C	1.8	2.7	mA	
		Full range	2.7			

† Full range is -40°C to +85°C.

NOTE 4: Typical values are based on the input offset voltage shift observed through 168 hours of operating life test at  $T_A = 150^\circ C$  extrapolated to  $T_A = 25^\circ C$  using the Arrhenius equation and assuming an activation energy of 0.96 eV.

**TLC2202I operating characteristics at specified free-air temperature,  $V_{DD} \pm = \pm 5$  V**

PARAMETER	TEST CONDITIONS	$T_A \dagger$	TLC2202I			UNIT
			MIN	TYP	MAX	
SR Slew rate at unity gain	$V_O = \pm 2.3 V, R_L = 10 k\Omega, C_L = 100 pF$	25°C	1.8	2.7	$V/\mu s$	
		Full range	1.2			
$V_n$ Equivalent input noise voltage	$f = 10 \text{ Hz}$	25°C	18		$nV/\sqrt{Hz}$	
	$f = 1 \text{ kHz}$	25°C	8			
$V_{N(PP)}$ Peak-to-peak equivalent input noise voltage	$f = 0.1 \text{ to } 1 \text{ Hz}$	25°C	0.5		$\mu V$	
	$f = 0.1 \text{ to } 10 \text{ Hz}$	25°C	0.7			
$I_n$ Equivalent input noise current		25°C	0.6		$fA/\sqrt{Hz}$	
Gain-bandwidth product	$f = 10 \text{ kHz}, R_L = 10 k\Omega, C_L = 100 pF$	25°C	1.9		MHz	
$\phi_m$ Phase margin at unity gain	$R_L = 10 k\Omega, C_L = 100 pF$	25°C	48°			

† Full range is -40°C to +85°C.



**TLC220x, TLC220xA, TLC220xB, TLC220xY**  
**Advanced LinCMOS™ LOW-NOISE PRECISION**  
**OPERATIONAL AMPLIFIERS**

SLOS175B – FEBRUARY 1997 – REVISED JANUARY 2008

**TLC2202I electrical characteristics at specified free-air temperature,  $V_{DD\pm} = \pm 5\text{ V}$  (unless otherwise noted)**

PARAMETER	TEST CONDITIONS	$T_A$ †	TLC2202AI			TLC2202BI			UNIT
			MIN	TYP	MAX	MIN	TYP	MAX	
$V_{IO}$ Input offset voltage	$V_{IC} = 0, R_S = 50\ \Omega$	25°C	80	500	80	500	$\mu\text{V}$		
		Full range	700		700				
$\alpha_{VIO}$ Temperature coefficient of input offset voltage		Full range	0.5		0.5		$\mu\text{V}/^\circ\text{C}$		
Input offset voltage long-term drift (see Note 4)		25°C	0.001	0.005	0.001	0.005	$\mu\text{V}/\text{mo}$		
$I_{IO}$ Input offset current		25°C	0.5	60	0.5	60	$\text{pA}$		
		Full range	150		150				
$I_{IB}$ Input bias current		25°C	1	60	1	60	$\text{pA}$		
		Full range	150		150				
$V_{ICR}$ Common-mode input voltage range	$R_S = 50\ \Omega$	Full range	-5 to 2.7		-5 to 2.7		V		
$V_{OM+}$ Maximum positive peak output voltage swing	$R_L = 10\ \text{k}\Omega$	25°C	4.7	4.8	4.7	4.8	V		
		Full range	4.7		4.7				
$V_{OM-}$ Maximum negative peak output voltage swing		25°C	-4.7	-4.9	-4.7	-4.9	V		
		Full range	-4.7		-4.7				
$A_{VD}$ Large-signal differential voltage amplification	$V_O = \pm 4\text{ V}, R_L = 500\ \text{k}\Omega$	25°C	300	560	300	560	V/mV		
		Full range	150		150				
	$V_O = \pm 4\text{ V}, R_L = 10\ \text{k}\Omega$	25°C	50	100	50	100			
		Full range	25		25				
CMRR Common-mode rejection ratio	$V_{IC} = V_{ICRmin}, V_O = 0, R_S = 50\ \Omega$	25°C	80	115	80	115	dB		
		Full range	80		80				
$k_{SVR}$ Supply-voltage rejection ratio ( $\Delta V_{DD\pm}/\Delta V_{IO}$ )	$V_{DD\pm} \pm 2.3\text{ V to } \pm 8\text{ V}$	25°C	80	110	80	110	dB		
		Full range	80		80				
$I_{DD}$ Supply current	$V_O = 0, \text{ No load}$	25°C	1.8	2.7	1.8	2.7	mA		
		Full range	2.7		2.7				

† Full range is  $-40^\circ\text{C}$  to  $+85^\circ\text{C}$ .

NOTE 4: Typical values are based on the input offset voltage shift observed through 168 hours of operating life test at  $T_A = 150^\circ\text{C}$  extrapolated to  $T_A = 25^\circ\text{C}$  using the Arrhenius equation and assuming an activation energy of 0.96 eV.

**TLC2202I operating characteristics at specified free-air temperature,  $V_{DD\pm} = \pm 5\text{ V}$**

PARAMETER	TEST CONDITIONS	$T_A$ †	TLC2202AI			TLC2202BI			UNIT
			MIN	TYP	MAX	MIN	TYP	MAX	
SR Slew rate at unity gain	$V_O = \pm 2.3\text{ V}, R_L = 10\ \text{k}\Omega, C_L = 100\ \text{pF}$	25°C	1.8	2.7	1.8	2.7	$\text{V}/\mu\text{s}$		
		Full range	1.2		1.2				
$V_n$ Equivalent input noise voltage (see Note 5)	$f = 10\ \text{Hz}$	25°C	18	35	18	30	$\text{nV}/\sqrt{\text{Hz}}$		
	$f = 1\ \text{kHz}$	25°C	8	15	8	12			
$V_{N(PP)}$ Peak-to-peak equivalent input noise voltage	$f = 0.1\ \text{to } 1\ \text{Hz}$	25°C	0.5		0.5		$\mu\text{V}$		
	$f = 0.1\ \text{to } 10\ \text{Hz}$	25°C	0.7		0.7				
$I_n$ Equivalent input noise current		25°C	0.6		0.6		$\text{fA}/\sqrt{\text{Hz}}$		
Gain-bandwidth product	$f = 10\ \text{kHz}, R_L = 10\ \text{k}\Omega, C_L = 100\ \text{pF}$	25°C	1.9		1.9		MHz		
$\phi_m$ Phase margin at unity gain	$R_I = 10\ \text{k}\Omega, C_I = 100\ \text{pF}$	25°C	48°		48°				

† Full range is  $-40^\circ\text{C}$  to  $+85^\circ\text{C}$ .

NOTE 5: This parameter is tested on a sample basis for the TLC2202A and on all devices for the TLC2202B. For other test requirements, please contact the factory. This statement has no bearing on testing or nontesting of other parameters.

**TLC220x, TLC220xA, TLC220xB, TLC220xY**  
**Advanced LinCMOS™ LOW-NOISE PRECISION**  
**OPERATIONAL AMPLIFIERS**

SLOS175B – FEBRUARY 1997 – REVISED JANUARY 2008

**TLC2202I electrical characteristics at specified free-air temperature,  $V_{DD} = 5\text{ V}$  (unless otherwise noted)**

PARAMETER	TEST CONDITIONS	$T_A$ †	TLC2202I			UNIT
			MIN	TYP	MAX	
$V_{IO}$ Input offset voltage	$V_{IC} = 0, R_S = 50\ \Omega$	25°C	100	1000	$\mu\text{V}$	
		Full range	1200			
$\alpha_{V_{IO}}$ Temperature coefficient of input offset voltage		Full range	0.5		$\mu\text{V}/^\circ\text{C}$	
Input offset voltage long-term drift (see Note 4)		25°C	0.001	0.005	$\mu\text{V}/\text{mo}$	
$I_{IO}$ Input offset current		25°C	0.5	60	$\text{pA}$	
		Full range	150			
$I_{IB}$ Input bias current		25°C	1	60	$\text{pA}$	
		Full range	150			
$V_{ICR}$ Common-mode input voltage range	$R_S = 50\ \Omega$	Full range	0 to 2.7	$\text{V}$		
$V_{OH}$ Maximum high-level output voltage	$R_L = 10\ \text{k}\Omega$	25°C	4.7	4.8	$\text{V}$	
		Full range	4.7			
$V_{OL}$ Maximum low-level output voltage	$I_O = 0$	25°C	0	50	$\text{mV}$	
		Full range	50			
$A_{VD}$ Large-signal differential voltage amplification	$V_O = 1\ \text{V to } 4\ \text{V}, R_L = 500\ \text{k}\Omega$	25°C	150	315	$\text{V}/\text{mV}$	
		Full range	100			
	$V_O = 1\ \text{V to } 4\ \text{V}, R_L = 10\ \text{k}\Omega$	25°C	25	55		
		Full range	15			
CMRR Common-mode rejection ratio	$V_O = 0, V_{IC} = V_{ICRmin}, R_S = 50\ \Omega$	25°C	75	110	$\text{dB}$	
		Full range	75			
$k_{SVR}$ Supply-voltage rejection ratio ( $\Delta V_{DD\pm}/\Delta V_{IO}$ )	$V_{DD} = 4.6\ \text{V to } 16\ \text{V}$	25°C	80	110	$\text{dB}$	
		Full range	80			
$I_{DD}$ Supply current	$V_O = 2.5\ \text{V}, \text{ No load}$	25°C	1.7	2.6	$\text{mA}$	
		Full range	2.6			

† Full range is  $-40^\circ\text{C}$  to  $+85^\circ\text{C}$ .

NOTE 4: Typical values are based on the input offset voltage shift observed through 168 hours of operating life test at  $T_A = 150^\circ\text{C}$  extrapolated to  $T_A = 25^\circ\text{C}$  using the Arrhenius equation and assuming an activation energy of 0.96 eV.

**TLC2202I operating characteristics at specified free-air temperature,  $V_{DD} = 5\ \text{V}$**

PARAMETER	TEST CONDITIONS	$T_A$ †	TLC2202I			UNIT
			MIN	TYP	MAX	
SR Slew rate at unity gain	$V_O = 0.5\ \text{V to } 2.5\ \text{V}, R_L = 10\ \text{k}\Omega, C_L = 100\ \text{pF}$	25°C	1.6	2.5	$\text{V}/\mu\text{s}$	
		Full range	1			
$V_n$ Equivalent input noise voltage	$f = 10\ \text{Hz}$	25°C	18		$\text{nV}/\sqrt{\text{Hz}}$	
	$f = 1\ \text{kHz}$	25°C	8			
$V_{N(PP)}$ Peak-to-peak equivalent input noise voltage	$f = 0.1\ \text{to } 1\ \text{Hz}$	25°C	0.5		$\mu\text{V}$	
	$f = 0.1\ \text{to } 10\ \text{Hz}$	25°C	0.7			
$I_n$ Equivalent input noise current		25°C	0.6		$\text{fA}/\sqrt{\text{Hz}}$	
Gain-bandwidth product	$f = 10\ \text{kHz}, R_L = 10\ \text{k}\Omega, C_L = 100\ \text{pF}$	25°C	1.9		$\text{MHz}$	
$\phi_m$ Phase margin at unity gain	$R_L = 10\ \text{k}\Omega, C_L = 100\ \text{pF}$	25°C	47°			

† Full range is  $-40^\circ\text{C}$  to  $+85^\circ\text{C}$ .

**TLC220x, TLC220xA, TLC220xB, TLC220xY**  
**Advanced LinCMOS™ LOW-NOISE PRECISION**  
**OPERATIONAL AMPLIFIERS**

SLOS175B – FEBRUARY 1997 – REVISED JANUARY 2008

**TLC2202I electrical characteristics at specified free-air temperature,  $V_{DD} = 5\text{ V}$  (unless otherwise noted)**

PARAMETER	TEST CONDITIONS	$T_A$ †	TLC2202AI			TLC2202BI			UNIT
			MIN	TYP	MAX	MIN	TYP	MAX	
$V_{IO}$ Input offset voltage		25°C	80	500		80	500	$\mu\text{V}$	
		Full range			700		700		
$\alpha_{VIO}$ Temperature coefficient of input offset voltage	$V_{IC} = 0, R_S = 50\ \Omega$	Full range	0.5			0.5			$\mu\text{V}/^\circ\text{C}$
Input offset voltage long-term drift (see Note 4)		25°C	0.001	0.005		0.001	0.005	$\mu\text{V}/\text{mo}$	
$I_{IO}$ Input offset current		25°C	0.5	60		0.5	60	$\text{pA}$	
		Full range	150			150			
$I_{IB}$ Input bias current		25°C	1	60		1	60	$\text{pA}$	
	Full range	150			150				
$V_{ICR}$ Common-mode input voltage range	$R_S = 50\ \Omega$	Full range	0 to 2.7		0 to 2.7		V		
$V_{OH}$ Maximum high-level output voltage	$R_L = 10\ \text{k}\Omega$	25°C	4.7	4.8		4.7	4.8	V	
		Full range	4.7			4.7			
$V_{OL}$ Maximum low-level output voltage	$I_O = 0$	25°C		0	50		0	50	mV
		Full range	50			50			
$A_{VD}$ Large-signal differential voltage amplification	$V_O = 1\ \text{V to } 4\ \text{V}, R_L = 500\ \text{k}\Omega$	25°C	150	315		150	315	V/mV	
		Full range	100			100			
	$V_O = 1\ \text{V to } 4\ \text{V}, R_L = 10\ \text{k}\Omega$	25°C	25	55		25	55		
		Full range	15			15			
CMRR Common-mode rejection ratio	$V_{IC} = V_{ICR\text{min}}, V_O = 0, R_S = 50\ \Omega$	25°C	75	110		75	110	dB	
		Full range	75			75			
$k_{SVR}$ Supply-voltage rejection ratio ( $\Delta V_{DD\pm}/\Delta V_{IO}$ )	$V_{DD} = 4.6\ \text{V to } 16\ \text{V}$	25°C	80	110		80	110	dB	
		Full range	80			80			
$I_{DD}$ Supply current	$V_O = 2.5\ \text{V}, \text{ No load}$	25°C		1.7	2.6		1.7	2.6	mA
		Full range	2.6			2.6			

† Full range is  $-40^\circ\text{C}$  to  $+85^\circ\text{C}$

NOTE 4: Typical values are based on the input offset voltage shift observed through 168 hours of operating life test at  $T_A = 150^\circ\text{C}$  extrapolated to  $T_A = 25^\circ\text{C}$  using the Arrhenius equation and assuming an activation energy of 0.96 eV.

**TLC2202I operating characteristics at specified free-air temperature,  $V_{DD} = 5\ \text{V}$**

PARAMETER	TEST CONDITIONS	$T_A$ †	TLC2202AI			TLC2202BI			UNIT	
			MIN	TYP	MAX	MIN	TYP	MAX		
SR Slew rate at unity gain	$V_O = 0.5\ \text{V to } 2.5\ \text{V}, R_L = 10\ \text{k}\Omega, C_L = 100\ \text{pF}$	25°C	1.6	2.5		1.6	2.5	V/ $\mu\text{s}$		
		Full range	1			1				
$V_n$ Equivalent input noise voltage (see Note 5)	$f = 10\ \text{Hz}$	25°C		18	35		18	30	nV/ $\sqrt{\text{Hz}}$	
	$f = 1\ \text{kHz}$	25°C		8	15		8	12		
$V_{N(PP)}$ Peak-to-peak equivalent input noise voltage	$f = 0.1\ \text{to } 1\ \text{Hz}$	25°C		0.5			0.5			$\mu\text{V}$
	$f = 0.1\ \text{to } 10\ \text{Hz}$	25°C		0.7			0.7			
$I_n$ Equivalent input noise current		25°C		0.6			0.6			fA/ $\sqrt{\text{Hz}}$
Gain-bandwidth product	$f = 10\ \text{kHz}, R_L = 10\ \text{k}\Omega, C_L = 100\ \text{pF}$	25°C		1.9			1.9			MHz
$\phi_m$ Phase margin at unity gain	$R_I = 10\ \text{k}\Omega, C_I = 100\ \text{pF}$	25°C		47°			47°			

† Full range is  $-40^\circ\text{C}$  to  $+85^\circ\text{C}$

NOTE 5: This parameter is tested on a sample basis for the TLC2202A and on all devices for the TLC2202B. For other test requirements, please contact the factory. This statement has no bearing on testing or nontesting of other parameters.

**TLC220x, TLC220xA, TLC220xB, TLC220xY**  
**Advanced LinCMOS™ LOW-NOISE PRECISION**  
**OPERATIONAL AMPLIFIERS**

SLOS175B – FEBRUARY 1997 – REVISED JANUARY 2008

**TLC2201M electrical characteristics at specified free-air temperature,  $V_{DD\pm} = \pm 5\text{ V}$  (unless otherwise noted)**

PARAMETER	TEST CONDITIONS	$T_A$ †	TLC2201M			UNIT
			MIN	TYP	MAX	
$V_{IO}$ Input offset voltage	$V_{IC} = 0, R_S = 50\ \Omega$	25°C	100	500	$\mu\text{V}$	
		Full range	700			
$\alpha_{V_{IO}}$ Temperature coefficient of input offset voltage		Full range	0.5		$\mu\text{V}/^\circ\text{C}$	
Input offset voltage long-term drift (see Note 4)		25°C	0.001	0.005	$\mu\text{V}/\text{mo}$	
		25°C	0.5	60	$\text{pA}$	
$I_{IO}$ Input offset current		Full range	500			
$I_{IB}$ Input bias current		25°C	1	60	$\text{pA}$	
		Full range	500			
$V_{ICR}$ Common-mode input voltage range	$R_S = 50\ \Omega$	Full range	-5 to 2.7		V	
$V_{OM+}$ Maximum positive peak output voltage swing	$R_L = 10\ \text{k}\Omega$	25°C	4.7	4.8	V	
		Full range	4.7			
$V_{OM-}$ Maximum negative peak output voltage swing		25°C	-4.7	-4.9	V	
		Full range	-4.7			
$A_{VD}$ Large-signal differential voltage amplification	$V_O = \pm 4\ \text{V}, R_L = 500\ \text{k}\Omega$	25°C	400	560	V/mV	
		Full range	200			
	$V_O = \pm 4\ \text{V}, R_L = 10\ \text{k}\Omega$	25°C	90	100		
		Full range	45			
CMRR Common-mode rejection ratio	$V_{IC} = V_{ICRmin}, V_O = 0, R_S = 50\ \Omega$	25°C	90	115	dB	
		Full range	85			
$k_{SVR}$ Supply voltage rejection ratio ( $\Delta V_{DD\pm}/\Delta V_{IO}$ )	$V_{DD\pm} = \pm 2.3\ \text{V to } \pm 8\ \text{V}$	25°C	90	110	dB	
		Full range	85			
$I_{DD}$ Supply current	$V_O = 0, \text{ No load}$	25°C	1.1	1.5	mA	
		Full range	1.5			

† Full range is -55°C to 125°C.

NOTE 4: Typical values are based on the input offset voltage shift observed through 168 hours of operating life test at  $T_A = 150^\circ\text{C}$  extrapolated to  $T_A = 25^\circ\text{C}$  using the Arrhenius equation and assuming an activation energy of 0.96 eV.

**TLC2201M operating characteristics at specified free-air temperature,  $V_{DD\pm} = \pm 5\ \text{V}$**

PARAMETER	TEST CONDITIONS	$T_A$ †	TLC2201M			UNIT
			MIN	TYP	MAX	
SR Slew rate at unity gain	$V_O = \pm 2.3\ \text{V}, R_L = 10\ \text{k}\Omega, C_L = 100\ \text{pF}$	25°C	2	2.7	$\text{V}/\mu\text{s}$	
		Full range	1.3			
$V_n$ Equivalent input noise voltage	$f = 10\ \text{Hz}$	25°C	18		$\text{nV}/\sqrt{\text{Hz}}$	
	$f = 1\ \text{kHz}$	25°C	8			
$V_{N(PP)}$ Peak-to-peak equivalent input noise voltage	$f = 0.1\ \text{to } 1\ \text{Hz}$	25°C	0.5		$\mu\text{V}$	
	$f = 0.1\ \text{to } 10\ \text{Hz}$	25°C	0.7			
$I_n$ Equivalent input noise current		25°C	0.6		$\text{fA}/\sqrt{\text{Hz}}$	
Gain-bandwidth product	$f = 10\ \text{kHz}, R_L = 10\ \text{k}\Omega, C_L = 100\ \text{pF}$	25°C	1.9		MHz	
$\phi_m$ Phase margin	$R_L = 10\ \text{k}\Omega, C_L = 100\ \text{pF}$	25°C	48°			

† Full range is -55°C to 125°C.

**TLC220x, TLC220xA, TLC220xB, TLC220xY**  
**Advanced LinCMOS™ LOW-NOISE PRECISION**  
**OPERATIONAL AMPLIFIERS**

SLOS175B – FEBRUARY 1997 – REVISED JANUARY 2008

**TLC2201M electrical characteristics at specified free-air temperature,  $V_{DD\pm} = \pm 5\text{ V}$  (unless otherwise noted)**

PARAMETER	TEST CONDITIONS	$T_A$ †	TLC2201AM			TLC2201BM			UNIT
			MIN	TYP	MAX	MIN	TYP	MAX	
$V_{IO}$ Input offset voltage	$V_{IC} = 0, R_S = 50\ \Omega$	25°C	80	200		80	200	$\mu\text{V}$	
		Full range		400		400			
$\alpha_{VIO}$ Temperature coefficient of input offset voltage		Full range	0.5			0.5		$\mu\text{V}/^\circ\text{C}$	
Input offset voltage long-term drift (see Note 4)		25°C	0.001	0.005		0.001	0.005	$\mu\text{V}/\text{mo}$	
$I_{IO}$ Input offset current		25°C	0.5	60		0.5	60	$\text{pA}$	
		Full range		500		500			
$I_{IB}$ Input bias current	25°C	1	60		1	60	$\text{pA}$		
	Full range		500		500				
$V_{ICR}$ Common-mode input voltage range	$R_S = 50\ \Omega$	Full range	-5 to 2.7			-5 to 2.7	V		
$V_{OM+}$ Maximum positive peak output voltage swing	$R_L = 10\ \text{k}\Omega$	25°C	4.7	4.8		4.7	4.8	V	
		Full range	4.7			4.7			
$V_{OM-}$ Maximum negative peak output voltage swing		25°C	-4.7	-4.9		-4.7	-4.9	V	
		Full range	-4.7			-4.7			
$A_{VD}$ Large-signal differential voltage amplification	$V_O = \pm 4\ \text{V}, R_L = 500\ \text{k}\Omega$	25°C	400	560		400	560	V/mV	
		Full range	200			200			
	$V_O = \pm 4\ \text{V}, R_L = 10\ \text{k}\Omega$	25°C	90	100		90	100		
		Full range	45			45			
CMRR Common-mode rejection ratio	$V_{IC} = V_{ICRmin}, V_O = 0, R_S = 50\ \Omega$	25°C	90	115		90	115	dB	
		Full range	85			85			
$k_{SVR}$ Supply voltage rejection ratio ( $\Delta V_{DD\pm}/\Delta V_{IO}$ )	$V_{DD\pm} = \pm 2.3\ \text{V to } \pm 8\ \text{V}$	25°C	90	110		90	110	dB	
		Full range	85			85			
$I_{DD}$ Supply current	$V_O = 0, \text{ No load}$	25°C	1.1	1.5		1.1	1.5	mA	
		Full range		1.5			1.5		

† Full range is  $-55^\circ\text{C}$  to  $125^\circ\text{C}$ .

NOTE 4: Typical values are based on the input offset voltage shift observable through 168 hours of operating life test at  $T_A = 150^\circ\text{C}$  extrapolated to  $T_A = 25^\circ\text{C}$  using the Arrhenius equation and assuming an activation energy of 0.96 eV.

**TLC220x, TLC220xA, TLC220xB, TLC220xY**  
**Advanced LinCMOS™ LOW-NOISE PRECISION**  
**OPERATIONAL AMPLIFIERS**

SLOS175B – FEBRUARY 1997 – REVISED JANUARY 2008

**TLC2201M operating characteristics at specified free-air temperature,  $V_{DD\pm} = \pm 5\text{ V}$**

PARAMETER	TEST CONDITIONS	T <sub>A</sub> †	TLC2201AM			TLC2201BM			UNIT
			MIN	TYP	MAX	MIN	TYP	MAX	
SR Slew rate at unity gain	V <sub>O</sub> = ±2.3 V, R <sub>L</sub> = 10 kΩ, C <sub>L</sub> = 100 pF	25°C	2	2.7		2	2.7		V/μs
		Full range	1.3			1.3			
V <sub>n</sub> Equivalent input noise voltage (see Note 5)	f = 10 Hz	25°C		18	35		18	30	nV/√Hz
	f = 1 kHz	25°C		8	15		8	12	
V <sub>N(PP)</sub> Peak-to-peak equivalent input noise voltage	f = 0.1 to 1 Hz	25°C		0.5			0.5		μV
	f = 0.1 to 10 Hz	25°C		0.7			0.7		
I <sub>n</sub> Equivalent input noise current		25°C		0.6			0.6		fA/√Hz
Gain-bandwidth product	f = 10 kHz, R <sub>L</sub> = 10 kΩ, C <sub>L</sub> = 100 pF	25°C		1.9			1.9		MHz
φ <sub>m</sub> Phase margin at unity gain	R <sub>L</sub> = 10 kΩ, C <sub>L</sub> = 100 pF	25°C		48°			48°		

† Full range is –55°C to 125°C.

NOTE 5: This parameter is tested on a sample basis for the TLC2201A and on all devices for the TLC2201B. For other test requirements, please contact the factory. This statement has no bearing on testing or nontesting of other parameters.

**TLC220x, TLC220xA, TLC220xB, TLC220xY**  
**Advanced LinCMOS™ LOW-NOISE PRECISION**  
**OPERATIONAL AMPLIFIERS**

SLOS175B – FEBRUARY 1997 – REVISED JANUARY 2008

**TLC2201M electrical characteristics at specified free-air temperature,  $V_{DD} = 5\text{ V}$  (unless otherwise noted)**

PARAMETER	TEST CONDITIONS	$T_A$ †	TLC2201M			UNIT
			MIN	TYP	MAX	
$V_{IO}$ Input offset voltage	$V_{IC} = 0, R_S = 50\ \Omega$	25°C		100	500	$\mu\text{V}$
		Full range			700	
$\alpha_{VIO}$ Temperature coefficient of input offset voltage		Full range		0.5		$\mu\text{V}/^\circ\text{C}$
Input offset voltage long-term drift (see Note 4)		25°C		0.001	0.005*	$\mu\text{V}/\text{mo}$
$I_{IO}$ Input offset current		25°C		0.5	60	$\text{pA}$
		Full range			500	
$I_{IB}$ Input bias current		25°C		1	60	$\text{pA}$
		Full range			500	
$V_{ICR}$ Common-mode input voltage range		$R_S = 50\ \Omega$	Full range	0 to 2.7		V
$V_{OH}$ Maximum high-level output voltage		$R_L = 10\ \text{k}\Omega$	25°C	4.7	4.8	V
	Full range		4.7			
$V_{OL}$ Maximum low-level output voltage	$I_O = 0$	25°C		0 50	mV	
		Full range		50		
$A_{VD}$ Large-signal differential voltage amplification	$V_O = 1\text{ V to }4\text{ V}, R_L = 500\ \text{k}\Omega$	25°C	150	315	V/mV	
		Full range	75			
	$V_O = 1\text{ V to }4\text{ V}, R_L = 10\ \text{k}\Omega$	25°C	25	55		
		Full range	10			
CMRR Common-mode rejection ratio	$V_{IC} = V_{ICR\text{min}}, V_O = 0, R_S = 50\ \Omega$	25°C	90	110	dB	
		Full range	85			
$k_{SVR}$ Supply voltage rejection ratio ( $\Delta V_{DD\pm} / \Delta V_{IO}$ )	$V_{DD} = 4.6\text{ V to }16\text{ V}$	25°C	90	110	dB	
		Full range	85			
$I_{DD}$ Supply current	$V_O = 2.5\text{ V}, \text{ No load}$	25°C		1 1.5	mA	
		Full range		1.5		

\*On products compliant to MIL-PRF-38535, Class B, this parameter is not production tested.

† Full range is  $-55^\circ\text{C}$  to  $125^\circ\text{C}$ .

NOTE 4: Typical values are based on the input offset voltage shift observed through 168 hours of operating life test at  $T_A = 150^\circ\text{C}$  extrapolated to  $T_A = 25^\circ\text{C}$  using the Arrhenius equation and assuming an activation energy of 0.96 eV.

**TLC2201M operating characteristics at specified free-air temperature,  $V_{DD} = 5\text{ V}$**

PARAMETER	TEST CONDITIONS	$T_A$ †	TLC2201M			UNIT
			MIN	TYP	MAX	
SR Slew rate at unity gain	$V_O = 0.5\text{ V to }2.5\text{ V}, R_L = 10\ \text{k}\Omega, C_L = 100\ \text{pF}$	25°C	1.8	2.5	$\text{V}/\mu\text{s}$	
		Full range	1.1			
$V_n$ Equivalent input noise voltage	$f = 10\ \text{Hz}$	25°C		18	$\text{nV}/\sqrt{\text{Hz}}$	
	$f = 1\ \text{kHz}$	25°C		8		
$V_{N(PP)}$ Peak-to-peak equivalent input noise voltage	$f = 0.1\text{ to }1\ \text{Hz}$	25°C		0.5	$\mu\text{V}$	
	$f = 0.1\text{ to }10\ \text{Hz}$	25°C		0.7		
$I_n$ Equivalent input noise current		25°C		0.6	$\text{fA}/\sqrt{\text{Hz}}$	
Gain-bandwidth product	$f = 10\ \text{kHz}, R_L = 10\ \text{k}\Omega, C_L = 100\ \text{pF}$	25°C		1.8	MHz	
$\phi_m$ Phase margin at unity gain	$R_L = 10\ \text{k}\Omega, C_L = 100\ \text{pF}$	25°C		45°		

† Full range is  $-55^\circ\text{C}$  to  $125^\circ\text{C}$ .

**TLC220x, TLC220xA, TLC220xB, TLC220xY**  
**Advanced LinCMOS™ LOW-NOISE PRECISION**  
**OPERATIONAL AMPLIFIERS**

SLOS175B – FEBRUARY 1997 – REVISED JANUARY 2008

**TLC2201M electrical characteristics at specified free-air temperature,  $V_{DD} = 5\text{ V}$  (unless otherwise noted)**

PARAMETER	TEST CONDITIONS	$T_A$ †	TLC2201AM			TLC2201BM			UNIT
			MIN	TYP	MAX	MIN	TYP	MAX	
$V_{IO}$ Input offset voltage	$V_{IC} = 0, R_S = 50\ \Omega$	25°C	80	200		80	200	$\mu\text{V}$	
		Full range			400		400		
$\alpha_{VIO}$ Temperature coefficient of input offset voltage		Full range	0.5			0.5		$\mu\text{V}/^\circ\text{C}$	
Input offset voltage long-term drift (see Note 4)		25°C	0.001	0.005		0.001	0.005	$\mu\text{V}/\text{mo}$	
$I_{IO}$ Input offset current		25°C	0.5	60		0.5	60	$\text{pA}$	
		Full range			500		500		
$I_{IB}$ Input bias current	25°C	1	60		1	60	$\text{pA}$		
	Full range			500		500			
$V_{ICR}$ Common-mode input voltage range	$R_S = 50\ \Omega$	Full range	0 to 2.7			0 to 2.7	V		
$V_{OH}$ Maximum high-level output voltage	$R_L = 10\ \text{k}\Omega$	25°C	4.7	4.8		4.7	4.8	V	
		Full range	4.7			4.7			
$V_{OL}$ Maximum low-level output voltage	$I_O = 0$	25°C		0	50		0	V	
		Full range			50		50		
$A_{VD}$ Large-signal differential voltage amplification	$V_O = 1\ \text{V to } 4\ \text{V}, R_L = 500\ \text{k}\Omega$	25°C	150	315		150	315	V/mV	
		Full range	75			75			
	$V_O = 1\ \text{V to } 4\ \text{V}, R_L = 10\ \text{k}\Omega$	25°C	25	55		25	55		
		Full range	10			10			
CMRR Common-mode rejection ratio	$V_{IC} = V_{ICRmin}, V_O = 0, R_S = 50\ \Omega$	25°C	90	110		90	110	dB	
		Full range	85			85			
$k_{SVR}$ Supply voltage rejection ratio ( $\Delta V_{DD\pm}/\Delta V_{IO}$ )	$V_{DD} = 4.6\ \text{V to } 16\ \text{V}$	25°C	90	110		90	110	dB	
		Full range	85			85			
$I_{DD}$ Supply current	$V_O = 2.5\ \text{V}, \text{ No load}$	25°C	1.1	1.5		1.1	1.5	mA	
		Full range			1.5		1.5		

† Full range is  $-55^\circ\text{C}$  to  $125^\circ\text{C}$ .

NOTE 4: Typical values are based on the input offset voltage shift observable through 168 hours of operating life test at  $T_A = 150^\circ\text{C}$  extrapolated to  $T_A = 25^\circ\text{C}$  using the Arrhenius equation and assuming an activation energy of 0.96 eV.



**TLC220x, TLC220xA, TLC220xB, TLC220xY**  
**Advanced LinCMOS™ LOW-NOISE PRECISION**  
**OPERATIONAL AMPLIFIERS**

SLOS175B – FEBRUARY 1997 – REVISED JANUARY 2008

**TLC2201M operating characteristics at specified free-air temperature,  $V_{DD} = 5\text{ V}$**

PARAMETER	TEST CONDITIONS	$T_A$ †	TLC2201AM			TLC2201BM			UNIT
			MIN	TYP	MAX	MIN	TYP	MAX	
SR Slew rate at unity gain	$V_O = 0.5\text{ V to }2.5\text{ V}$ , $R_L = 10\text{ k}\Omega$ , $C_L = 100\text{ pF}$	25°C	1.8	2.5		1.8	2.5		V/ $\mu$ s
		Full range	1.1			1.1			
$V_n$ Equivalent input noise voltage (see Note 5)	$f = 10\text{ Hz}$ $f = 1\text{ kHz}$	25°C		18	35		18	30	nV/ $\sqrt{\text{Hz}}$
		25°C		8	15		8	12	
$V_{N(PP)}$ Peak-to-peak equivalent input noise voltage	$f = 0.1\text{ to }1\text{ Hz}$ $f = 0.1\text{ to }10\text{ Hz}$	25°C		0.5			0.5		$\mu$ V
		25°C		0.7			0.7		
$I_n$ Equivalent input noise current		25°C		0.6			0.6		fA/ $\sqrt{\text{Hz}}$
Gain-bandwidth product	$f = 10\text{ kHz}$ , $R_L = 10\text{ k}\Omega$ , $C_L = 100\text{ pF}$	25°C		1.8			1.8		MHz
$\phi_m$ Phase margin at unity gain	$R_L = 10\text{ k}\Omega$ , $C_L = 100\text{ pF}$	25°C		45°			45°		

† Full range is  $-55^\circ\text{C}$  to  $125^\circ\text{C}$ .

NOTE 5: This parameter is tested on a sample basis for the TLC2201A and on all devices for the TLC2201B. For other test requirements, please contact the factory. This statement has no bearing on testing or nontesting of other parameters.

**TLC220x, TLC220xA, TLC220xB, TLC220xY**  
**Advanced LinCMOS™ LOW-NOISE PRECISION**  
**OPERATIONAL AMPLIFIERS**

SLOS175B – FEBRUARY 1997 – REVISED JANUARY 2008

**TLC2202M electrical characteristics at specified free-air temperature,  $V_{DD\pm} = \pm 5\text{ V}$  (unless otherwise noted)**

PARAMETER	TEST CONDITIONS	$T_A$ †	TLC2202M			UNIT
			MIN	TYP	MAX	
$V_{IO}$ Input offset voltage	$V_{IC} = 0, R_S = 50\ \Omega$	25°C	100	1000	$\mu\text{V}$	
		Full range	1250			
$\alpha_{V_{IO}}$ Temperature coefficient of input offset voltage		Full range	0.5		$\mu\text{V}/^\circ\text{C}$	
Input offset voltage long-term drift (see Note 4)		25°C	0.001	0.005	$\mu\text{V}/\text{mo}$	
$I_{IO}$ Input offset current		25°C	0.5	60	$\text{pA}$	
		Full range	500			
$I_{IB}$ Input bias current		25°C	1	60	$\text{pA}$	
		Full range	500			
$V_{ICR}$ Common-mode input voltage range	$R_S = 50\ \Omega$	Full range	–5 to 2.7		V	
$V_{OM+}$ Maximum positive peak output voltage swing	$R_L = 10\ \text{k}\Omega$	25°C	4.7	4.8	V	
$V_{OM-}$ Maximum negative peak output voltage swing		Full range	4.7			
		25°C	–4.7	–4.9	V	
Full range		–4.7				
$A_{VD}$ Large-signal differential voltage amplification	$V_O = 1\ \text{V to } 4\ \text{V}, R_L = 500\ \text{k}\Omega$	25°C	300	560	V/mV	
		Full range	100			
	$V_O = 1\ \text{V to } 4\ \text{V}, R_L = 10\ \text{k}\Omega$	25°C	50	100		
		Full range	25			
CMRR Common-mode rejection ratio	$V_O = 0, V_{IC} = V_{ICRmin}, R_S = 50\ \Omega$	25°C	80	115	dB	
		Full range	80			
$k_{SVR}$ Supply-voltage rejection ratio ( $\Delta V_{DD\pm}/\Delta V_{IO}$ )	$V_{DD} = \pm 2.3\ \text{V to } \pm 8\ \text{V}$	25°C	80	110	dB	
		Full range	80			
$I_{DD}$ Supply current	$V_O = 0, \text{ No load}$	25°C	1.8	2.7	mA	
		Full range	2.7			

\*On products compliant to MIL-PRF-38535, Class B, this parameter is not production tested.

† Full range is –55°C to 125°C.

NOTE 4: Typical values are based on the input offset voltage shift observed through 168 hours of operating life test at  $T_A = 150^\circ\text{C}$  extrapolated to  $T_A = 25^\circ\text{C}$  using Arrhenius equation and assuming an activation energy of 0.96 eV.

**TLC2202M operating characteristics at specified free-air temperature,  $V_{DD\pm} = \pm 5\ \text{V}$**

PARAMETER	TEST CONDITIONS	$T_A$ †	TLC2202M			UNIT
			MIN	TYP	MAX	
SR Slew rate at unity gain	$V_O = \pm 2.3\ \text{V}, R_L = 10\ \text{k}\Omega, C_L = 100\ \text{pF}$	25°C	1.8	2.7	$\text{V}/\mu\text{s}$	
		Full range	1.1			
$V_n$ Equivalent input noise voltage	$f = 10\ \text{Hz}$	25°C	18		$\text{nV}/\sqrt{\text{Hz}}$	
	$f = 1\ \text{kHz}$	25°C	8			
$V_{N(PP)}$ Peak-to-peak equivalent input noise voltage	$f = 0.1\ \text{to } 1\ \text{Hz}$	25°C	0.5		$\mu\text{V}$	
	$f = 0.1\ \text{to } 10\ \text{Hz}$	25°C	0.7			
$I_n$ Equivalent input noise current		25°C	0.6		$\text{fA}/\sqrt{\text{Hz}}$	
Gain-bandwidth product	$f = 10\ \text{kHz}, R_L = 10\ \text{k}\Omega, C_L = 100\ \text{pF}$	25°C	1.9		MHz	
$\phi_m$ Phase margin at unity gain	$R_L = 10\ \text{k}\Omega, C_L = 100\ \text{pF}$	25°C	48°			

† Full range is –55°C to 125°C.

**TLC220x, TLC220xA, TLC220xB, TLC220xY**  
**Advanced LinCMOS™ LOW-NOISE PRECISION**  
**OPERATIONAL AMPLIFIERS**

SLOS175B – FEBRUARY 1997 – REVISED JANUARY 2008

**TLC2202M electrical characteristics at specified free-air temperature,  $V_{DD\pm} = \pm 5\text{ V}$  (unless otherwise noted)**

PARAMETER	TEST CONDITIONS	$T_A$ †	TLC2202AM			TLC2202BM			UNIT
			MIN	TYP	MAX	MIN	TYP	MAX	
$V_{IO}$ Input offset voltage		25°C	80	500		80	500	$\mu\text{V}$	
		Full range			750		750		
$\alpha_{VIO}$ Temperature coefficient of input offset voltage		Full range	0.5			0.5			$\mu\text{V}/^\circ\text{C}$
Input offset voltage long-term drift (see Note 4)	$V_{IC} = 0, R_S = 50\ \Omega$	25°C	0.001	0.005*		0.001	0.005*	$\mu\text{V}/\text{mo}$	
$I_{IO}$ Input offset current		25°C	0.5	60		0.5	60	$\text{pA}$	
		Full range			500		500		
$I_{IB}$ Input bias current		25°C	1	60		1	60	$\text{pA}$	
		Full range			500		500		
$V_{ICR}$ Common-mode input voltage range		$R_S = 50\ \Omega$	Full range	-5 to 2.7			-5 to 2.7		
$V_{OM+}$ Maximum positive peak output voltage swing	$R_L = 10\ \text{k}\Omega$	25°C	4.7	4.8		4.7	4.8	V	
		Full range	4.7			4.7			
$V_{OM-}$ Maximum negative peak output voltage swing		25°C	-4.7	-4.9		-4.7	-4.9	V	
		Full range	-4.7			-4.7			
$A_{VD}$ Large-signal differential voltage amplification	$V_O = \pm 4\text{ V}, R_L = 500\ \text{k}\Omega$	25°C	300	560		300	560	V/mV	
		Full range	100			100			
	$V_O = \pm 4\text{ V}, R_L = 10\ \text{k}\Omega$	25°C	50	100		50	100		
		Full range	25			25			
CMRR Common-mode rejection ratio	$V_O = 0, V_{IC} = V_{ICRmin}, R_S = 50\ \Omega$	25°C	80	115		80	115	dB	
		Full range	80			80			
$k_{SVR}$ Supply-voltage rejection ratio ( $\Delta V_{DD\pm} / \Delta V_{IO}$ )	$V_{DD\pm} = \pm 2.3\text{ V to } \pm 8\text{ V}$	25°C	80	110		80	110	dB	
		Full range	80			80			
$I_{DD}$ Supply current	$V_O = 0, \text{ No load}$	25°C	1.8	2.7		1.8	2.7	mA	
		Full range			2.7		2.7		

\*On products compliant to MIL-PRF-38535, Class B, this parameter is not production tested.

† Full range is  $-55^\circ\text{C}$  to  $125^\circ\text{C}$ .

NOTE 4: Typical values are based on the input offset voltage shift observed through 168 hours of operating life test at  $T_A = 150^\circ\text{C}$  extrapolated to  $T_A = 25^\circ\text{C}$  using the Arrhenius equation and assuming an activation energy of 0.96 eV.

**TLC220x, TLC220xA, TLC220xB, TLC220xY**  
**Advanced LinCMOS™ LOW-NOISE PRECISION**  
**OPERATIONAL AMPLIFIERS**

SLOS175B – FEBRUARY 1997 – REVISED JANUARY 2008

**TLC2202M operating characteristics at specified free-air temperature,  $V_{DD\pm} = \pm 5\text{ V}$**

PARAMETER	TEST CONDITIONS	$T_A$ †	TLC2202AM			TLC2202BM			UNIT
			MIN	TYP	MAX	MIN	TYP	MAX	
SR Slew rate at unity gain	$V_O = \pm 2.3\text{ V}$ , $R_L = 10\text{ k}\Omega$ , $C_L = 100\text{ pF}$	25°C	1.8	2.7		1.8	2.7		V/ $\mu\text{s}$
		Full range	1.1			1.1			
$V_n$ Equivalent input noise voltage (see Note 5)	f = 10 Hz	25°C		18	35*		18	30*	nV/ $\sqrt{\text{Hz}}$
	f = 1 kHz	25°C		8	15*		8	12*	
$V_{N(PP)}$ Peak-to-peak equivalent input noise voltage	f = 0.1 to 1 Hz	25°C		0.5			0.5		$\mu\text{V}$
	f = 0.1 to 10 Hz	25°C		0.7			0.7		
$I_n$ Equivalent input noise current		25°C		0.6			0.6		fA/ $\sqrt{\text{Hz}}$
Gain-bandwidth product	f = 10 kHz, $R_L = 10\text{ k}\Omega$ , $C_L = 100\text{ pF}$	25°C		1.9			1.9		MHz
$\phi_m$ Phase margin at unity gain	$R_L = 10\text{ k}\Omega$ , $C_L = 100\text{ pF}$	25°C		48°			48°		

\*On products compliant to MIL-PRF-38535, Class B, this parameter is not production tested.

† Full range is -55°C to 125°C.

NOTE 5: This parameter is tested on a sample basis for the TLC2202A and on all devices for the TLC2202B. For other test requirements, please contact the factory. This statement has no bearing on testing or nontesting of other parameters.

# TLC220x, TLC220xA, TLC220xB, TLC220xY Advanced LinCMOS™ LOW-NOISE PRECISION OPERATIONAL AMPLIFIERS

SLOS175B – FEBRUARY 1997 – REVISED JANUARY 2008

**TLC2202M electrical characteristics at specified free-air temperatures,  $V_{DD} = 5\text{ V}$  (unless otherwise noted)**

PARAMETER	TEST CONDITIONS	$T_A$ †	TLC2202M			UNIT
			MIN	TYP	MAX	
$V_{IO}$ Input offset voltage	$V_{IC} = 0, \quad R_S = 50\ \Omega$	25°C		100	1000	$\mu\text{V}$
		Full range			1250	
$\alpha_{V_{IO}}$ Temperature coefficient of input offset voltage		Full range		0.5		$\mu\text{V}/^\circ\text{C}$
Input offset voltage long-term drift (see Note 4)		25°C		0.001	0.005*	$\mu\text{V}/\text{mo}$
$I_{IO}$ Input offset current		25°C		0.5	60	$\text{pA}$
		Full range			500	
$I_{IB}$ Input bias current		25°C		1	60	$\text{pA}$
		Full range			500	
$V_{ICR}$ Common-mode input voltage range		$R_S = 50\ \Omega$	Full range	0 to 2.7		V
$V_{OH}$ Maximum high-level output voltage		$R_L = 10\ \text{k}\Omega$	25°C	4.7	4.8	V
	Full range		4.7			
$V_{OL}$ Maximum low-level output voltage	$I_O = 0$	25°C		0 50	mV	
		Full range		50		
$A_{VD}$ Large-signal differential voltage amplification	$V_O = 1\text{ V to }4\text{ V},$ $R_L = 500\ \text{k}\Omega$	25°C	150	315	V/mV	
		Full range	75			
	$V_O = 1\text{ V to }4\text{ V},$ $R_L = 10\ \text{k}\Omega$	25°C	25	55		
		Full range	10			
CMRR Common-mode rejection ratio	$V_{IC} = V_{ICR\text{min}}, \quad R_S = 50\ \Omega$	25°C	75	110	dB	
		Full range	75			
$k_{SVR}$ Supply-voltage rejection ratio ( $\Delta V_{DD\pm} / \Delta V_{IO}$ )	$V_{DD} = 4.6\text{ V to }16\text{ V}$	25°C	80	110	dB	
		Full range	80			
$I_{DD}$ Supply current	$V_O = 2.5\text{ V}, \quad \text{No load}$	25°C		1.7 2.6	mA	
		Full range		2.6		

\* On products compliant to MIL-PRF-38535, Class B, this parameter is not production tested.

† Full range is  $-55^\circ\text{C}$  to  $125^\circ\text{C}$ .

NOTE 4: Typical values are based on the input offset voltage shift observed through 168 hours of operating life test at  $T_A = 150^\circ\text{C}$  extrapolated to  $T_A = 25^\circ\text{C}$  using the Arrhenius equation and assuming an activation energy of 0.96 eV.

**TLC2202M operating characteristics at specified free-air temperature,  $V_{DD} = 5\text{ V}$**

PARAMETER	TEST CONDITIONS	$T_A$ †	TLC2202M			UNIT
			MIN	TYP	MAX	
SR Slew rate at unity gain	$V_O = 0.5\text{ V to }2.5\text{ V},$ $R_L = 10\ \text{k}\Omega, \quad C_L = 100\ \text{pF}$	25°C	1.6	2.5	$\text{V}/\mu\text{s}$	
		Full range	0.9			
$V_n$ Equivalent input noise voltage	$f = 10\ \text{Hz}$	25°C		18	$\text{nV}/\sqrt{\text{Hz}}$	
	$f = 1\ \text{kHz}$	25°C		8		
$V_{N(\text{PP})}$ Peak-to-peak equivalent input noise voltage	$f = 0.1\text{ to }1\ \text{Hz}$	25°C		0.5	$\mu\text{V}$	
	$f = 0.1\text{ to }10\ \text{Hz}$	25°C		0.7		
$I_n$ Equivalent input noise current		25°C		0.6	$\text{fA}/\sqrt{\text{Hz}}$	
Gain-bandwidth product	$f = 10\ \text{kHz}, \quad R_L = 10\ \text{k}\Omega,$ $C_L = 100\ \text{pF}$	25°C		1.9	MHz	
$\phi_m$ Phase margin at unity gain	$R_L = 10\ \text{k}\Omega, \quad C_L = 100\ \text{pF}$	25°C		47°		

† Full range is  $-55^\circ\text{C}$  to  $125^\circ\text{C}$ .

**TLC220x, TLC220xA, TLC220xB, TLC220xY**  
**Advanced LinCMOS™ LOW-NOISE PRECISION**  
**OPERATIONAL AMPLIFIERS**

SLOS175B – FEBRUARY 1997 – REVISED JANUARY 2008

**TLC2202M electrical characteristics at specified free-air temperature,  $V_{DD} = 5\text{ V}$  (unless otherwise noted)**

PARAMETER	TEST CONDITIONS	$T_A$ †	TLC2202AM			TLC2202BM			UNIT
			MIN	TYP	MAX	MIN	TYP	MAX	
$V_{IO}$ Input offset voltage	$V_{IC} = 0, R_S = 50\ \Omega$	25°C	80	500		80	500	$\mu\text{V}$	
		Full range			750		750		
$\alpha V_{IO}$ Temperature coefficient of input offset voltage		Full range	0.5			0.5			$\mu\text{V}/^\circ\text{C}$
Input offset voltage long-term drift (see Note 4)		25°C	0.001	0.005*		0.001	0.005*	$\mu\text{V}/\text{mo}$	
$I_{IO}$ Input offset current		25°C	0.5	60		0.5	60	$\text{pA}$	
		Full range			500		500		
$I_{IB}$ Input bias current	25°C	1	60		1	60	$\text{pA}$		
	Full range			500		500			
$V_{ICR}$ Common-mode input voltage range	$R_S = 50\ \Omega$	Full range	0 to 2.7		0 to 2.7		V		
$V_{OH}$ Maximum high-level output voltage	$R_L = 10\ \text{k}\Omega$	25°C	4.7	4.8		4.7	4.8	V	
		Full range	4.7			4.7			
$V_{OL}$ Maximum low-level output voltage	$I_O = 0$	25°C		0	50		0	mV	
		Full range			50		50		
$A_{VD}$ Large-signal differential voltage amplification	$V_O = 1\ \text{V to } 4\ \text{V}, R_L = 500\ \text{k}\Omega$	25°C	150	315		150	315	V/mV	
		Full range	75			75			
	$V_O = 1\ \text{V to } 4\ \text{V}, R_L = 10\ \text{k}\Omega$	25°C	25	55		25	55		
		Full range	10			10			
CMRR Common-mode rejection ratio	$V_O = 0, V_{IC} = V_{ICR\text{min}}, R_S = 50\ \Omega$	25°C	75	110		75	110	dB	
		Full range	75			75			
$k_{SVR}$ Supply-voltage rejection ratio ( $\Delta V_{DD\pm} / \Delta V_{IO}$ )	$V_{DD} = 4.6\ \text{V to } 16\ \text{V}$	25°C	80	110		80	110	dB	
		Full range	80			80			
$I_{DD}$ Supply current	$V_O = 2.5\ \text{V}, \text{ No load}$	25°C		1.7	2.6		1.7	mA	
		Full range			2.6		2.6		

\*On products compliant to MIL-PRF-38535, Class B, this parameter is not production tested.

† Full range is  $-55^\circ\text{C}$  to  $125^\circ\text{C}$

NOTE 4: Typical values are based on the input offset voltage shift observed through 168 hours of operating life test at  $T_A = 150^\circ\text{C}$  extrapolated to  $T_A = 25^\circ\text{C}$  using the Arrhenius equation and assuming an activation energy of 0.96 eV.

**TLC220x, TLC220xA, TLC220xB, TLC220xY**  
**Advanced LinCMOS™ LOW-NOISE PRECISION**  
**OPERATIONAL AMPLIFIERS**

SLOS175B – FEBRUARY 1997 – REVISED JANUARY 2008

**TLC2202M operating characteristics at specified free-air temperature,  $V_{DD} = 5\text{ V}$**

PARAMETER	TEST CONDITIONS	$T_A$ †	TLC2202AM			TLC2202BM			UNIT
			MIN	TYP	MAX	MIN	TYP	MAX	
SR Slew rate at unity gain	$V_O = 0.5\text{ V to }2.5\text{ V}$ , $R_L = 10\text{ k}\Omega$ , $C_L = 100\text{ pF}$	25°C	1.6	2.5		1.6	2.5		$\text{V}/\mu\text{s}$
		Full range	0.9			1.1			
$V_n$ Equivalent input noise voltage (see Note 5)	$f = 10\text{ Hz}$	25°C		18	35*		18	30*	$\text{nV}/\sqrt{\text{Hz}}$
	$f = 1\text{ kHz}$	25°C		8	15*		8	12*	
$V_{N(PP)}$ Peak-to-peak equivalent input noise voltage	$f = 0.1\text{ to }1\text{ Hz}$	25°C		0.5			0.5		$\mu\text{V}$
	$f = 0.1\text{ to }10\text{ Hz}$	25°C		0.7			0.7		
$I_n$ Equivalent input noise current		25°C		0.6			0.6		$\text{fA}/\sqrt{\text{Hz}}$
Gain-bandwidth product	$f = 10\text{ kHz}$ , $R_L = 10\text{ k}\Omega$ , $C_L = 100\text{ pF}$	25°C		1.9			1.9		MHz
$\phi_m$ Phase margin at unity gain	$R_L = 10\text{ k}\Omega$ , $C_L = 100\text{ pF}$	25°C		47°			47°		

\* On products compliant to MIL-PRF-38535, Class B, this parameter is not production tested.

† Full range is  $-55^\circ\text{C}$  to  $125^\circ\text{C}$

NOTE 5: This parameter is tested on a sample basis for the TLC2202A and on all devices for the TLC2202B. For other test requirements, please contact the factory. This statement has no bearing on testing or nontesting of other parameters.

**TLC220x, TLC220xA, TLC220xB, TLC220xY**  
**Advanced LinCMOS™ LOW-NOISE PRECISION**  
**OPERATIONAL AMPLIFIERS**

SLOS175B – FEBRUARY 1997 – REVISED JANUARY 2008

**TLC2201Y electrical characteristics at  $V_{DD\pm} = \pm 5\text{ V}$ ,  $T_A = 25^\circ\text{C}$  (unless otherwise noted)**

PARAMETER	TEST CONDITIONS	TLC2201Y			UNIT
		MIN	TYP	MAX	
$V_{IO}$ Input offset voltage	$V_{IC} = 0$ , $R_S = 50\ \Omega$	100			$\mu\text{V}$
Input offset voltage long-term drift (see Note 4)		0.001			$\mu\text{V}/\text{mo}$
$I_{IO}$ Input offset current		0.5			$\text{pA}$
$I_{IB}$ Input bias current		1			$\text{pA}$
$V_{OH}$ Maximum high-level output voltage	$R_L = 10\ \text{k}\Omega$	4.8			$\text{V}$
$V_{OL}$ Maximum low-level output voltage	$I_O = 0$	0			$\text{mV}$
$A_{VD}$ Large-signal differential voltage amplification	$V_O = 1\ \text{V to } 4\ \text{V}$ , $R_L = 500\ \Omega$	55			$\text{V}/\text{mV}$
	$V_O = 1\ \text{V to } 4\ \text{V}$ , $R_L = 10\ \Omega$	55			
CMRR Common-mode rejection ratio	$V_{IC} = V_{ICR\text{min}}$ , $V_O = 0$ , $R_S = 50\ \Omega$	110			$\text{dB}$
$k_{SVR}$ Supply voltage rejection ratio ( $\Delta V_{DD\pm} / \Delta V_{IO}$ )	$V_{DD} = 4.6\ \text{to } 16\ \text{V}$	110			$\text{dB}$
$I_{DD}$ Supply current per amplifier	$V_O = 2.5\ \text{V}$ , No load	1			$\text{mA}$

NOTE 4: Typical values are based on the input offset voltage shift observed through 168 hours of operating life test at  $T_A = 150^\circ\text{C}$  extrapolated to  $T_A = 25^\circ\text{C}$  using the Arrhenius equation and assuming an activation energy of 0.96 eV.

**TLC2201Y operating characteristics at  $V_{DD\pm} = \pm 5\ \text{V}$ ,  $T_A = 25^\circ\text{C}$**

PARAMETER	TEST CONDITIONS	TLC2201Y			UNIT
		MIN	TYP	MAX	
SR Positive slew rate at unity gain	$V_O = \pm 0.5\ \text{to } 2.5\ \text{V}$ , $R_L = 10\ \text{k}\Omega$ , $C_L = 100\ \text{pF}$	2.5			$\text{V}/\mu\text{s}$
$V_n$ Equivalent input noise voltage	$f = 10\ \text{Hz}$	18			$\text{nV}/\sqrt{\text{Hz}}$
	$f = 1\ \text{kHz}$	8			
$V_{N(PP)}$ Peak-to-peak equivalent input noise voltage	$f = 0.1\ \text{to } 1\ \text{Hz}$	0.5			$\mu\text{V}$
	$f = 0.1\ \text{to } 10\ \text{Hz}$	0.7			
$I_n$ Equivalent input noise current		0.6			$\text{pA}/\sqrt{\text{Hz}}$
Gain-bandwidth product	$f = 10\ \text{kHz}$ , $R_L = 10\ \text{k}\Omega$ , $C_L = 100\ \text{pF}$	1.8			$\text{MHz}$
$\phi_m$ Phase margin at unity gain	$R_L = 10\ \text{k}\Omega$ , $C_L = 100\ \text{pF}$	48°			



**TLC220x, TLC220xA, TLC220xB, TLC220xY**  
**Advanced LinCMOS™ LOW-NOISE PRECISION**  
**OPERATIONAL AMPLIFIERS**

SLOS175B – FEBRUARY 1997 – REVISED JANUARY 2008

**TLC2202Y electrical characteristics,  $V_{DD} = 5\text{ V}$ ,  $T_A = 25^\circ\text{C}$  (unless otherwise noted)**

PARAMETER	TEST CONDITIONS	TLC2202Y			UNIT
		MIN	TYP	MAX	
$V_{IO}$ Input offset voltage	$V_{IC} = 0$ , $R_S = 50\ \Omega$		100		$\mu\text{V}$
Input offset voltage long-term drift (see Note 4)			0.001		$\mu\text{V}/\text{mo}$
$I_{IO}$ Input offset current			0.5		$\text{pA}$
$I_{IB}$ Input bias current			1		$\text{pA}$
$V_{OH}$ Maximum high-level output voltage	$R_L = 10\ \text{k}\Omega$		4.8		$\text{V}$
$V_{OL}$ Maximum low-level output voltage	$I_O = 0$		0		$\text{mV}$
$A_{VD}$ Large-signal differential voltage amplification	$V_O = 1\ \text{V to } 4\ \text{V}$ , $R_L = 500\ \Omega$		315		$\text{V}/\text{mV}$
	$V_O = 1\ \text{V to } 4\ \text{V}$ , $R_L = 10\ \Omega$		55		
CMRR Common-mode rejection ratio	$V_O = 0$ , $V_{ICRmin}$ , $R_S = 50\ \Omega$		110		$\text{dB}$
$k_{SVR}$ Supply-voltage rejection ratio ( $\Delta V_{DCC}/\Delta V_{IO}$ )	$V_{DD} = 4.6\ \text{ to } 16\ \text{V}$		110		$\text{dB}$
$I_{DD}$ Supply current	$V_O = 2.5\ \text{V}$ , No load		1.7		$\text{mA}$

NOTE 4: Typical values are based on the input offset voltage shift observed through 168 hours of operating life test at  $T_A = 150^\circ\text{C}$  extrapolated to  $T_A = 25^\circ\text{C}$  using the Arrhenius equation and assuming an activation energy of 0.96 eV.

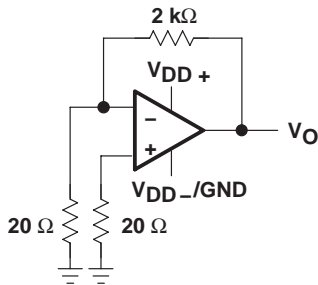
**TLC2202Y operating characteristics at  $V_{DD} = 5\ \text{V}$ ,  $T_A = 25^\circ\text{C}$**

PARAMETER	TEST CONDITIONS	TLC2202Y			UNIT
		MIN	TYP	MAX	
SR Positive slew rate at unity gain	$V_O = 0.5\ \text{V to } 2.5\ \text{V}$ , $R_L = 10\ \text{k}\Omega$ , $C_L = 100\ \text{pF}$		2.5		$\text{V}/\mu\text{s}$
$V_n$ Equivalent input noise voltage	$f = 10\ \text{Hz}$		18		$\text{nV}/\sqrt{\text{Hz}}$
	$f = 10\ \text{kHz}$		8		
$V_{N(PP)}$ Peak-to-peak equivalent input noise voltage	$f = 0.1\ \text{ to } 1\ \text{Hz}$		0.5		$\mu\text{V}$
	$f = 0.1\ \text{ to } 10\ \text{Hz}$		0.7		
$I_n$ Equivalent input noise current			0.6		$\text{pA}/\sqrt{\text{Hz}}$
$B_1$ Gain-bandwidth product	$f = 10\ \text{kHz}$ , $R_L = 10\ \text{k}\Omega$ , $C_L = 100\ \text{pF}$		1.9		$\text{MHz}$
$\phi_m$ Phase margin at unity gain	$R_L = 10\ \text{k}\Omega$ , $C_L = 100\ \text{pF}$		$47^\circ$		

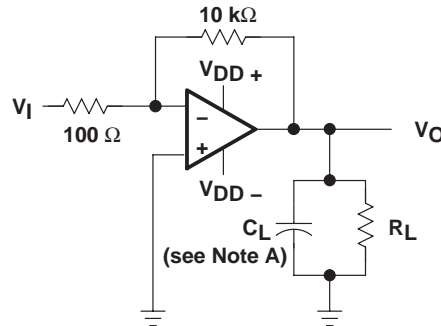
**TLC220x, TLC220xA, TLC220xB, TLC220xY**  
**Advanced LinCMOS™ LOW-NOISE PRECISION**  
**OPERATIONAL AMPLIFIERS**

SLOS175B – FEBRUARY 1997 – REVISED JANUARY 2008

**PARAMETER MEASUREMENT INFORMATION**

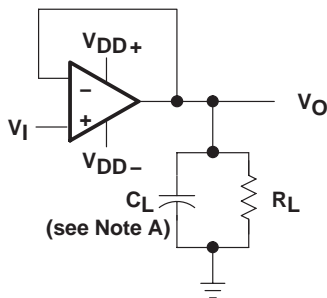


**Figure 1. Noise-Voltage Test Circuit**



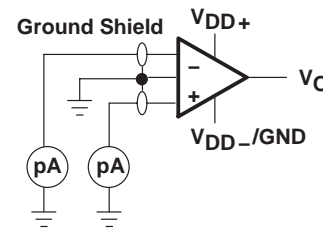
NOTE A:  $C_L$  includes fixture capacitance.

**Figure 2. Phase-Margin Test Circuit**



NOTE A:  $C_L$  includes fixture capacitance.

**Figure 3. Slew-Rate Test Circuit**



**Figure 4. Input-Bias and Offset-Current Test Circuit**

**typical values**

Typical values presented in this data sheet represent the median (50% point) of device parametric performance.

**input bias and offset current**

At the picoamp bias current level of the TLC220x, TLC220xA, and TLC220xB, accurate measurement of the bias current becomes difficult. Not only does this measurement require a picoammeter, but test socket leakages can easily exceed the actual device bias currents. To measure these small currents, Texas Instruments uses a two-step process. The socket leakage is measured using picoammeters with bias voltages applied but with no device in the socket. The device is then inserted in the socket, and a second test measuring both the socket leakage and the device input bias current is performed. The two measurements are then subtracted algebraically to determine the bias current of the device.

**noise**

Texas Instruments offers automated production noise testing to meet individual application requirements. Noise voltage at  $f = 10 \text{ Hz}$  and  $f = 1 \text{ kHz}$  is 100% tested on every TLC2201B device, while lot sample testing is performed on the TLC220xA. For other noise requirements, please contact the factory.

**TLC220x, TLC220xA, TLC220xB, TLC220xY**  
**Advanced LinCMOS™ LOW-NOISE PRECISION**  
**OPERATIONAL AMPLIFIERS**

SLOS175B – FEBRUARY 1997 – REVISED JANUARY 2008

**TYPICAL CHARACTERISTICS**

**Table of Graphs**

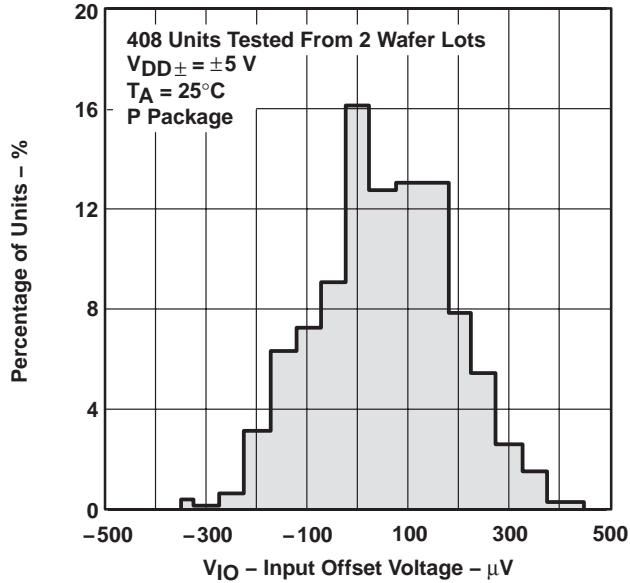
		<b>FIGURE</b>	
$V_{IO}$	Input offset voltage	Distribution	5, 6
$I_{IB}$	Input bias current	vs Common-mode input voltage	7
		vs Free-air temperature	8
$V_{OM}$	Maximum peak output voltage	vs Output current	9
		vs Free-air temperature	10
$V_{O(PP)}$	Maximum peak-to-peak output voltage	vs Frequency	11
$V_{OH}$	High-level output voltage	vs Frequency	12
		vs High-level output current	13
		vs Free-air temperature	14
$V_{OL}$	Low-level output voltage	vs Low-level output current	15
		vs Free-air temperature	16
$A_{VD}$	Large-signal differential voltage amplification	vs Frequency	17
		vs Free-air temperature	18
$I_{OS}$	Short-circuit output current	vs Supply voltage	19
		vs Free-air temperature	20
$CMRR$	Common-mode rejection ratio	vs Frequency	21
$I_{DD}$	Supply current	vs Supply voltage	22
		vs Free-air temperature	23, 24
	Pulse response	Small signal	25, 26
		Large signal	27, 28
$SR$	Slew rate	vs Supply voltage	29
		vs Free-air temperature	30
	Noise voltage (referred to input)	0.1 to 1 Hz	31
		0.1 to 10 Hz	32
	Gain-bandwidth product	vs Supply voltage	33, 34
		vs Free-air temperature	35
$\phi_m$	Phase margin	vs Supply voltage	36, 37
		vs Free-air temperature	38, 39
	Phase shift	vs Frequency	17

**TLC220x, TLC220xA, TLC220xB, TLC220xY**  
**Advanced LinCMOS™ LOW-NOISE PRECISION**  
**OPERATIONAL AMPLIFIERS**

SLOS175B – FEBRUARY 1997 – REVISED JANUARY 2008

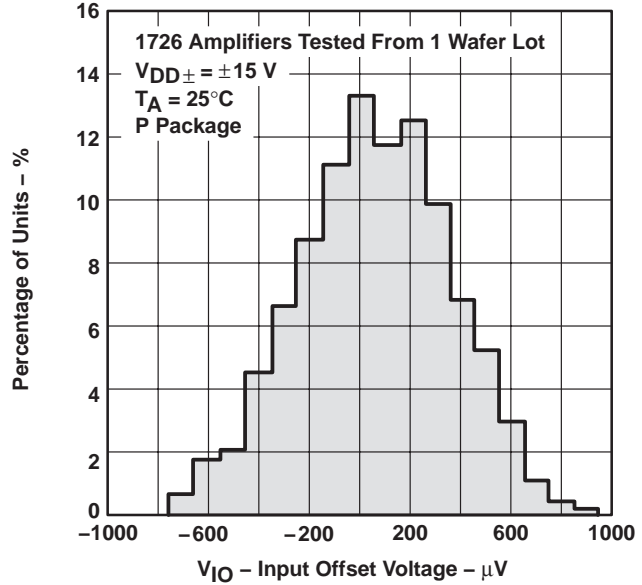
**TYPICAL CHARACTERISTICS**

**DISTRIBUTION OF TLC2201  
 INPUT OFFSET VOLTAGE**



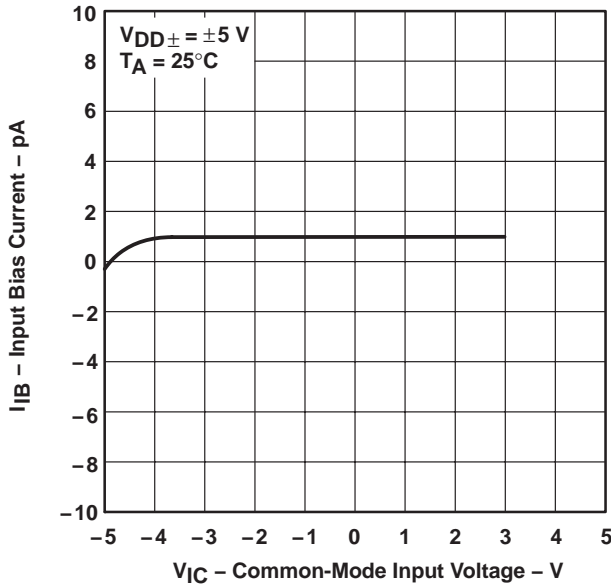
**Figure 5**

**TLC2202  
 DISTRIBUTION OF  
 INPUT OFFSET VOLTAGE**



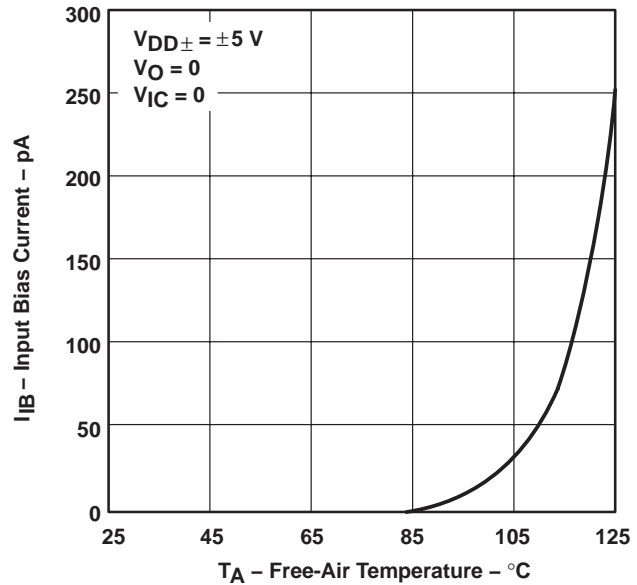
**Figure 6**

**INPUT BIAS CURRENT  
 VS  
 COMMON-MODE INPUT VOLTAGE**



**Figure 7**

**INPUT BIAS CURRENT†  
 VS  
 FREE-AIR TEMPERATURE**



**Figure 8**

† Data at high and low temperatures are applicable only within the rated operating free-air temperature ranges of the various devices.

TYPICAL CHARACTERISTICS

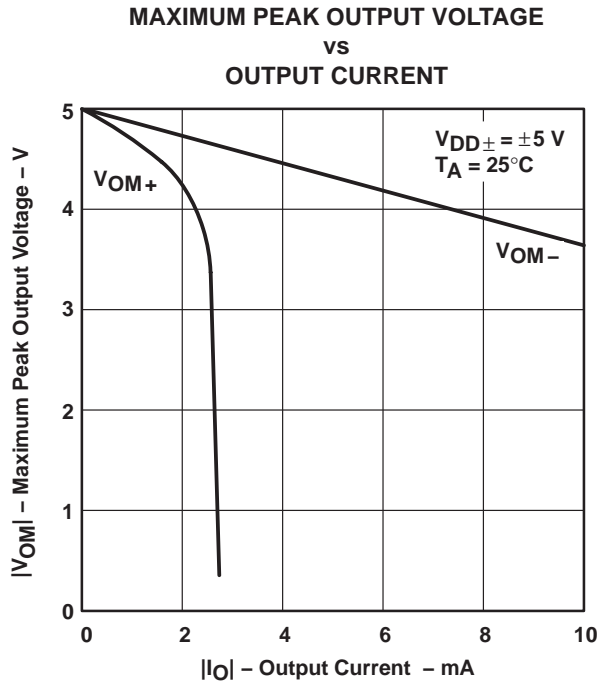


Figure 9

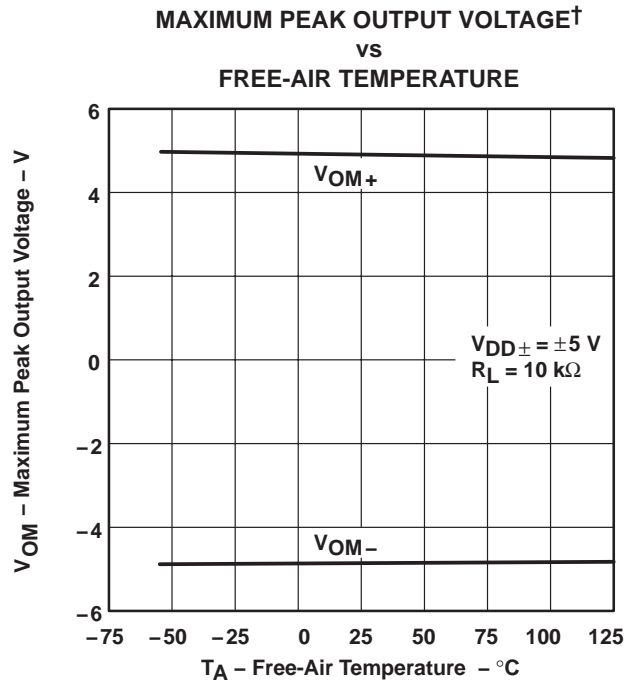


Figure 10

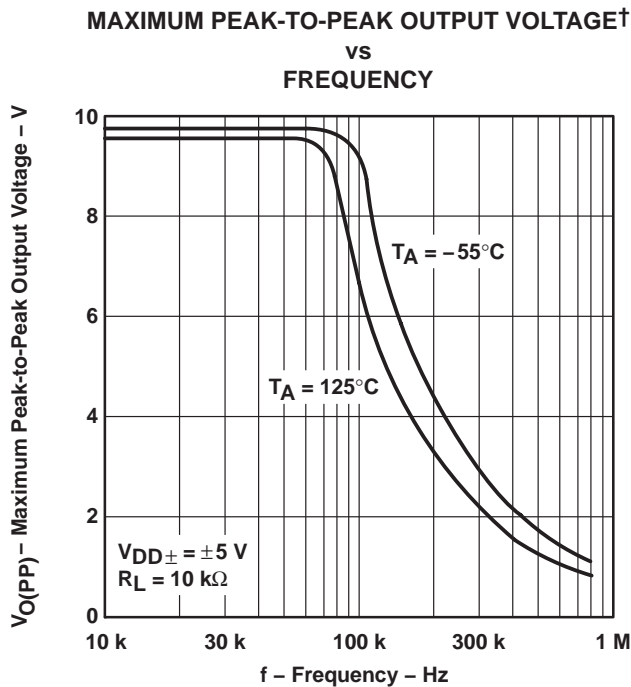


Figure 11

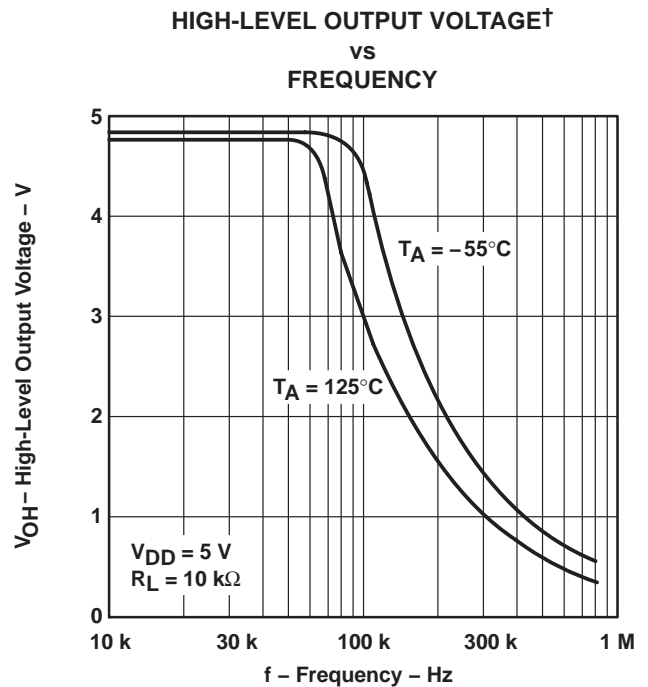


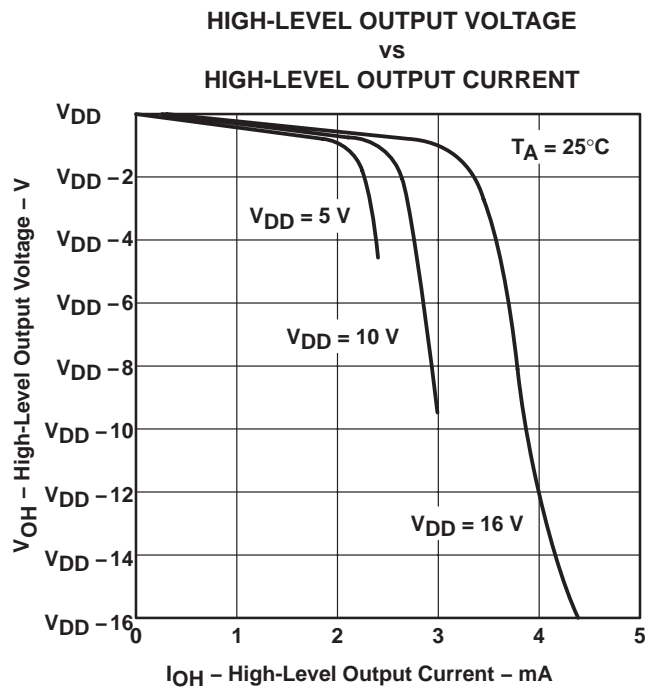
Figure 12

† Data at high and low temperatures are applicable only within the rated operating free-air temperature ranges of the various devices.

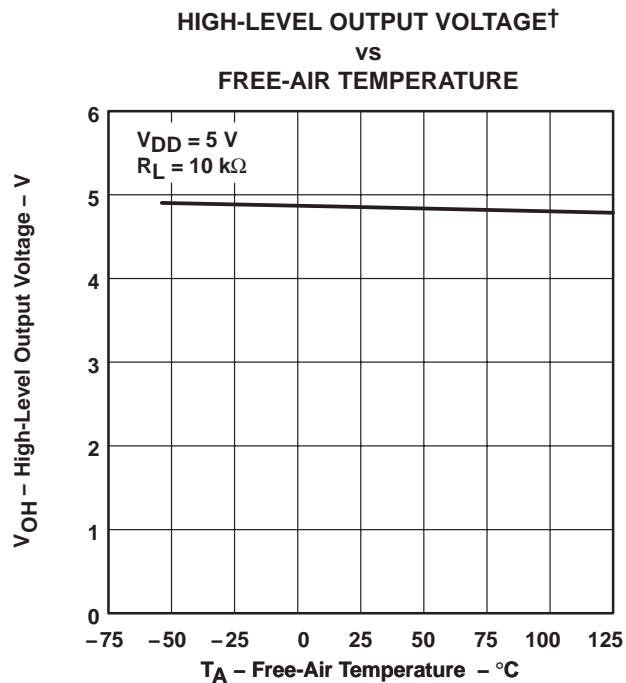
**TLC220x, TLC220xA, TLC220xB, TLC220xY**  
**Advanced LinCMOS™ LOW-NOISE PRECISION**  
**OPERATIONAL AMPLIFIERS**

SLOS175B – FEBRUARY 1997 – REVISED JANUARY 2008

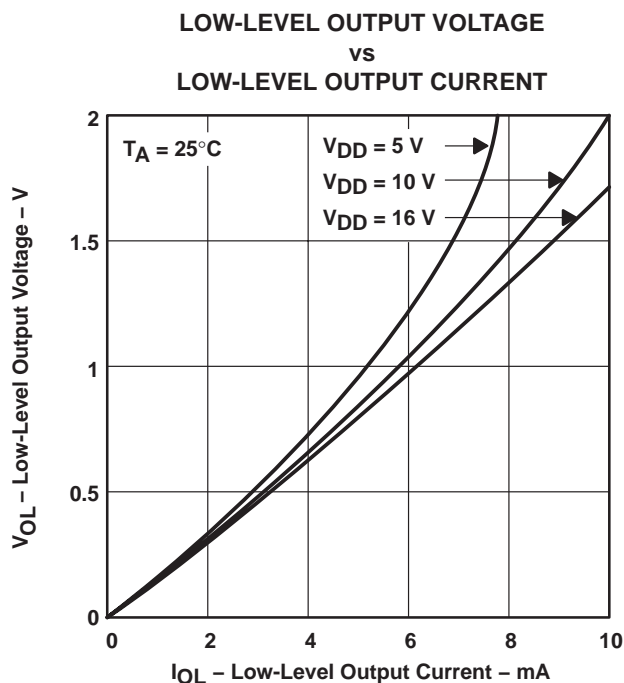
**TYPICAL CHARACTERISTICS**



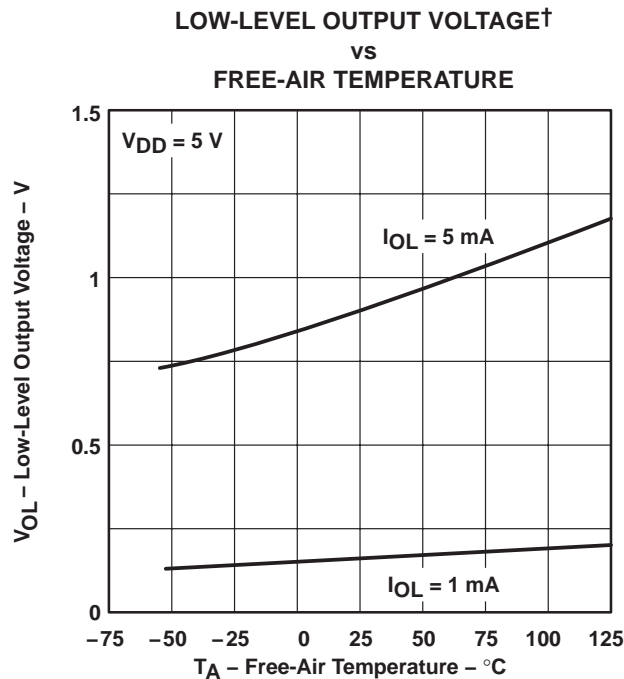
**Figure 13**



**Figure 14**



**Figure 15**



**Figure 16**

† Data at high and low temperatures are applicable only within the rated operating free-air temperature ranges of the various devices.

TYPICAL CHARACTERISTICS

LARGE-SIGNAL DIFFERENTIAL VOLTAGE  
 AMPLIFICATION AND PHASE SHIFT  
 vs  
 FREQUENCY

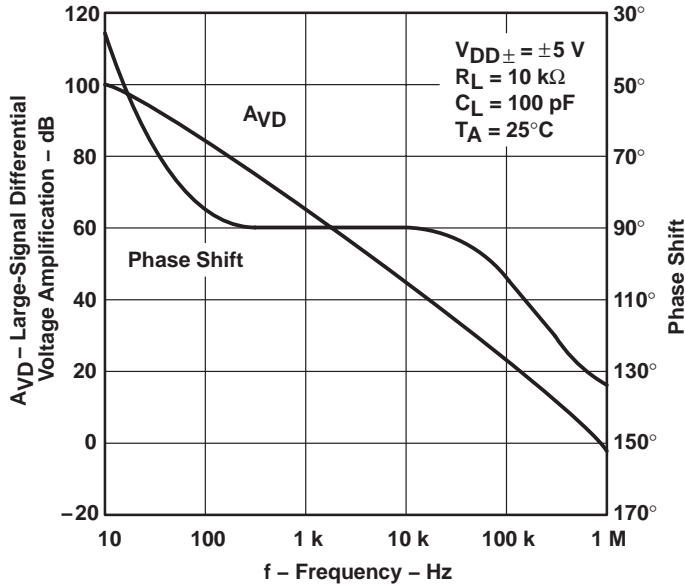


Figure 17

LARGE-SIGNAL DIFFERENTIAL VOLTAGE  
 AMPLIFICATION†  
 vs  
 FREE-AIR TEMPERATURE

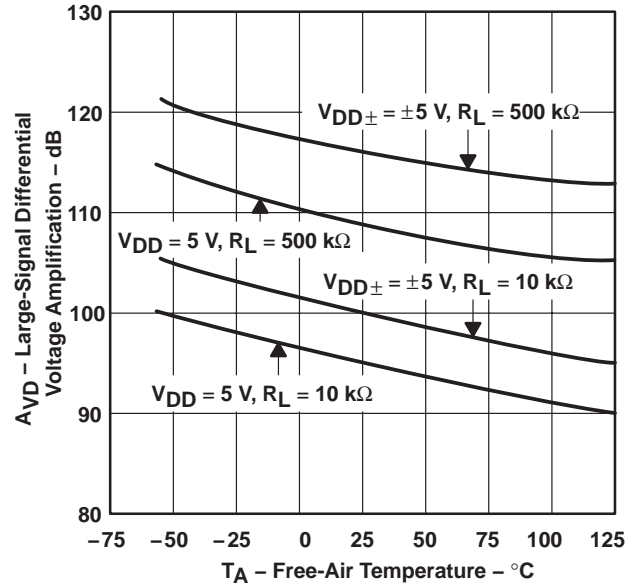


Figure 18

SHORT-CIRCUIT OUTPUT CURRENT  
 vs  
 SUPPLY VOLTAGE

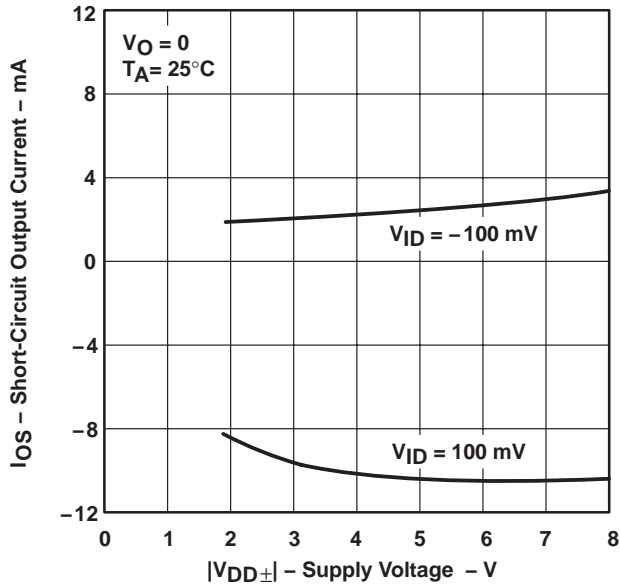


Figure 19

SHORT-CIRCUIT OUTPUT CURRENT†  
 vs  
 FREE-AIR TEMPERATURE

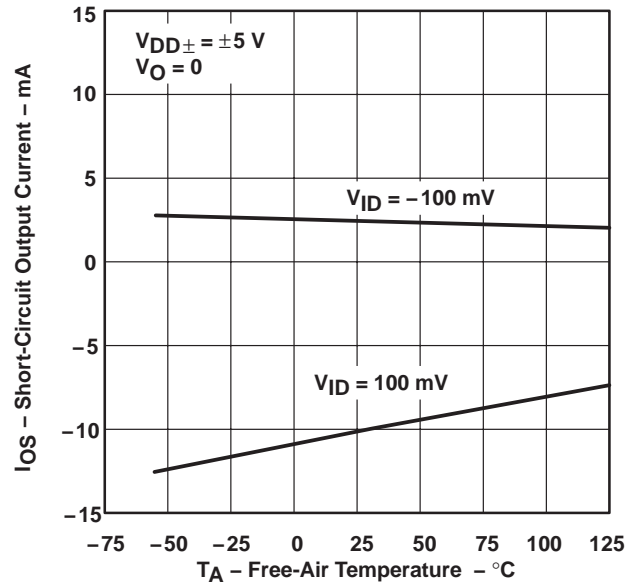


Figure 20

† Data at high and low temperatures are applicable only within the rated operating free-air temperature ranges of the various devices.

**TLC220x, TLC220xA, TLC220xB, TLC220xY**  
**Advanced LinCMOS™ LOW-NOISE PRECISION**  
**OPERATIONAL AMPLIFIERS**

SLOS175B – FEBRUARY 1997 – REVISED JANUARY 2008

**TYPICAL CHARACTERISTICS**

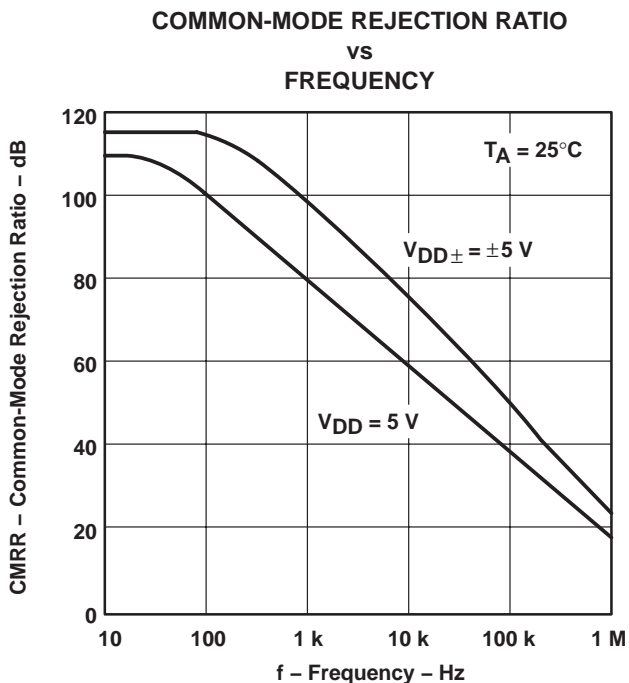


Figure 21

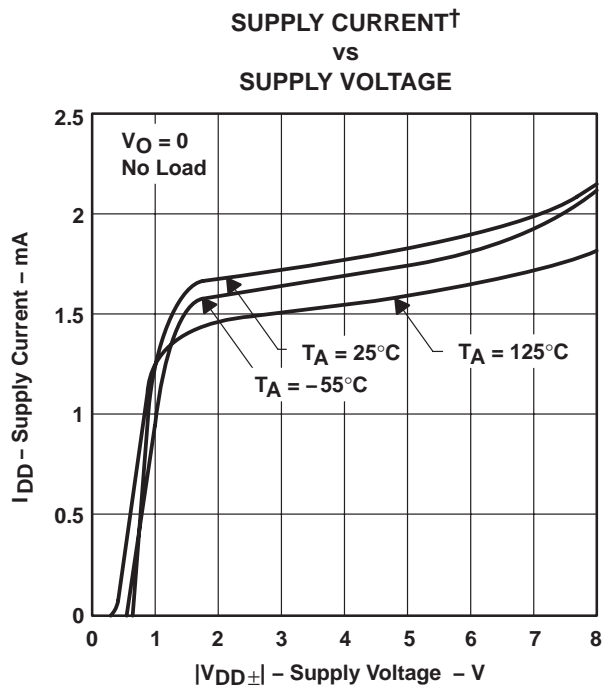


Figure 22

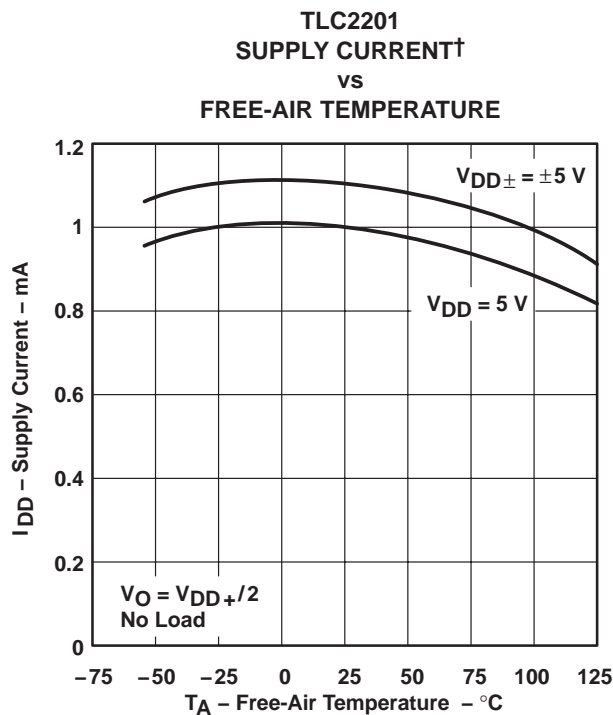


Figure 23

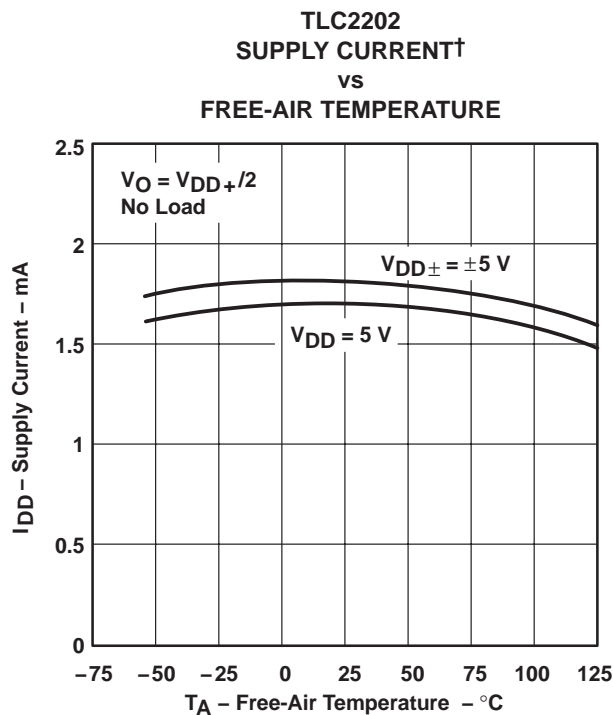


Figure 24

† Data at high and low temperatures are applicable only within the rated operating free-air temperature ranges of the various devices.



TYPICAL CHARACTERISTICS

VOLTAGE-FOLLOWER  
 SMALL-SIGNAL  
 PULSE RESPONSE

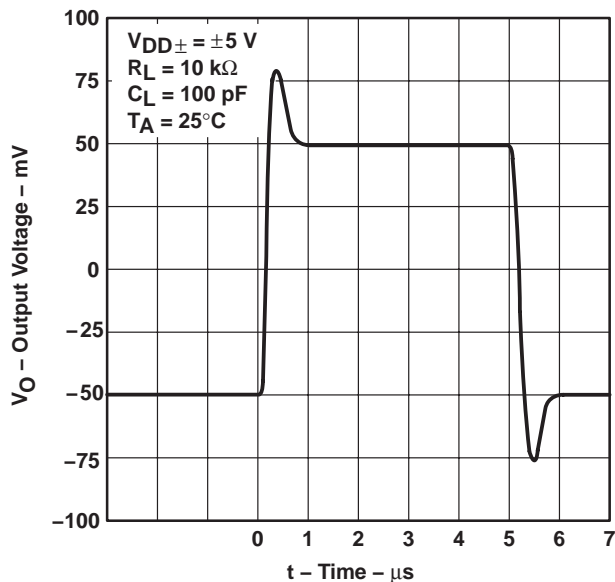


Figure 25

VOLTAGE-FOLLOWER  
 SMALL-SIGNAL  
 PULSE RESPONSE

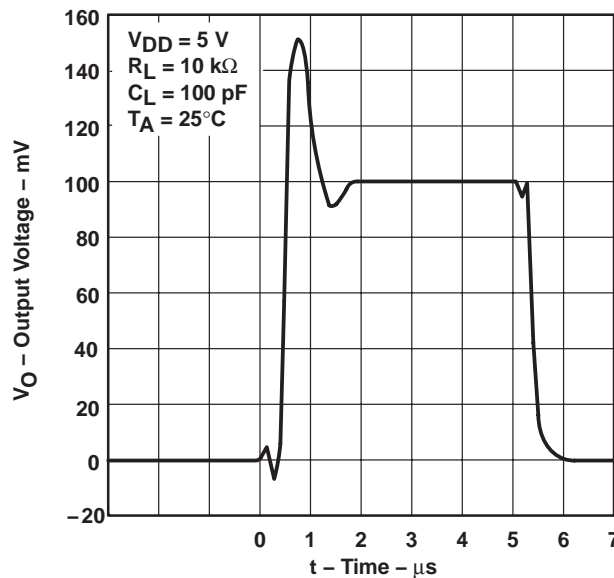


Figure 26

VOLTAGE-FOLLOWER  
 LARGE-SIGNAL  
 PULSE RESPONSE

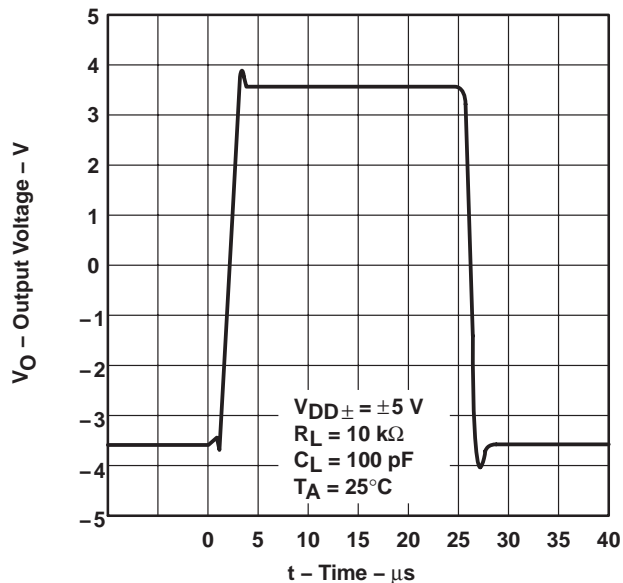


Figure 27

VOLTAGE-FOLLOWER  
 LARGE-SIGNAL  
 PULSE RESPONSE

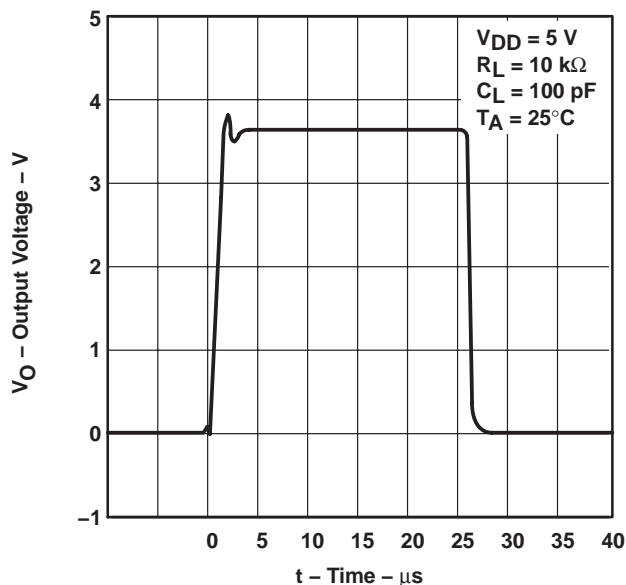
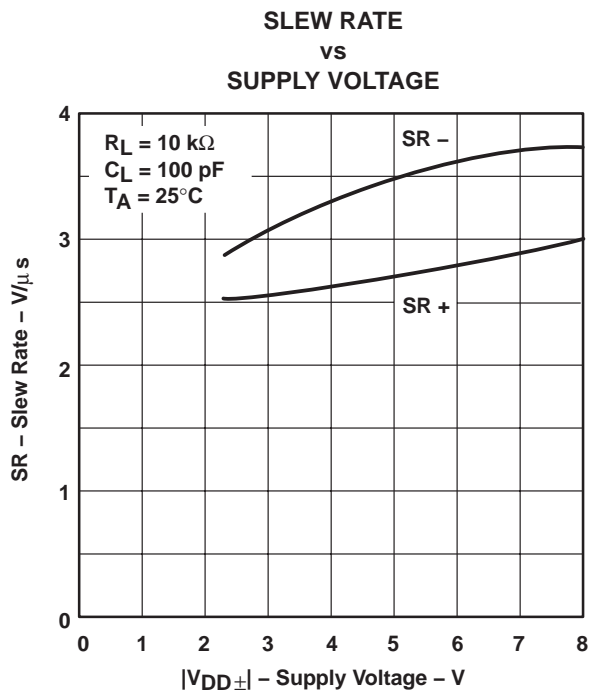


Figure 28

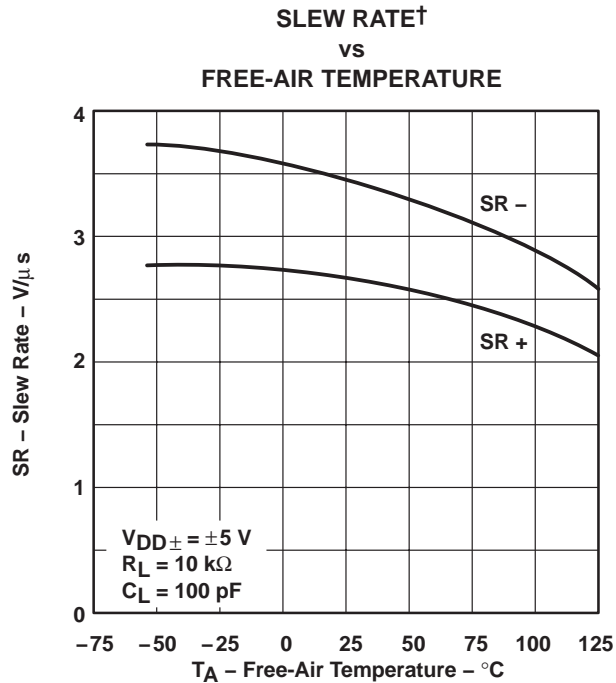
**TLC220x, TLC220xA, TLC220xB, TLC220xY**  
**Advanced LinCMOS™ LOW-NOISE PRECISION**  
**OPERATIONAL AMPLIFIERS**

SLOS175B – FEBRUARY 1997 – REVISED JANUARY 2008

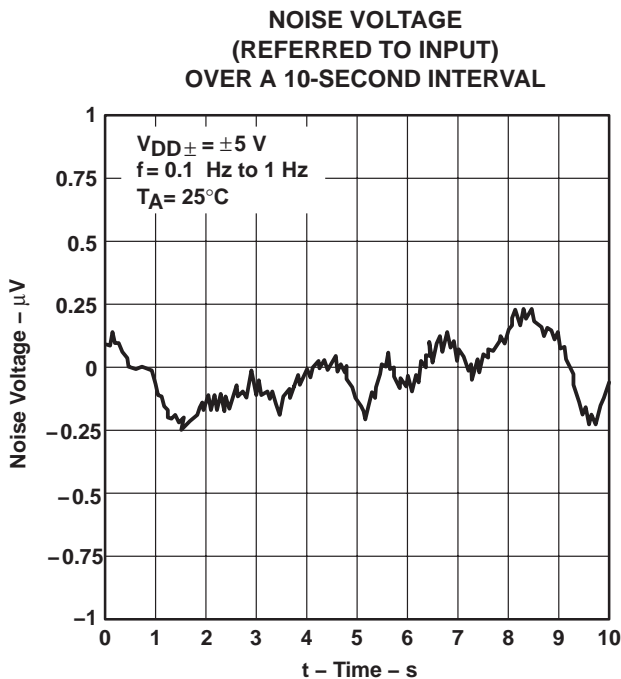
**TYPICAL CHARACTERISTICS**



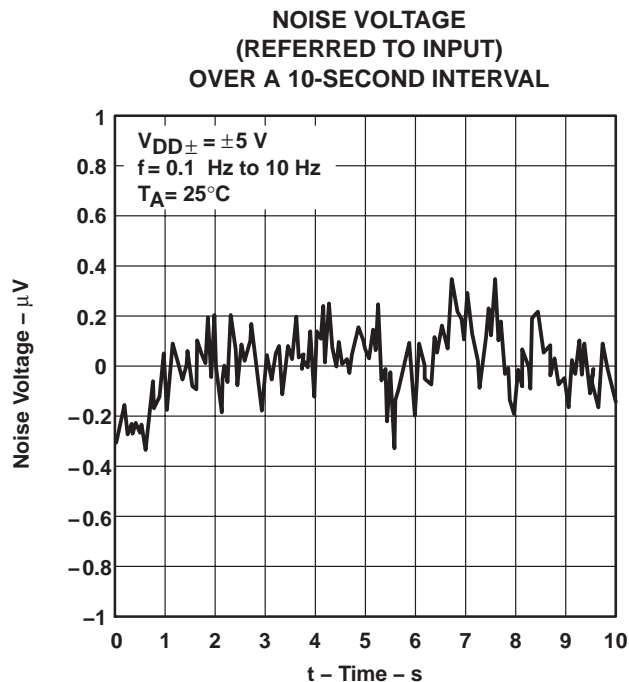
**Figure 29**



**Figure 30**



**Figure 31**



**Figure 32**

† Data at high and low temperatures are applicable only within the rated operating free-air temperature ranges of the various devices.

TYPICAL CHARACTERISTICS

TLC2201  
GAIN-BANDWIDTH PRODUCT  
vs  
SUPPLY VOLTAGE

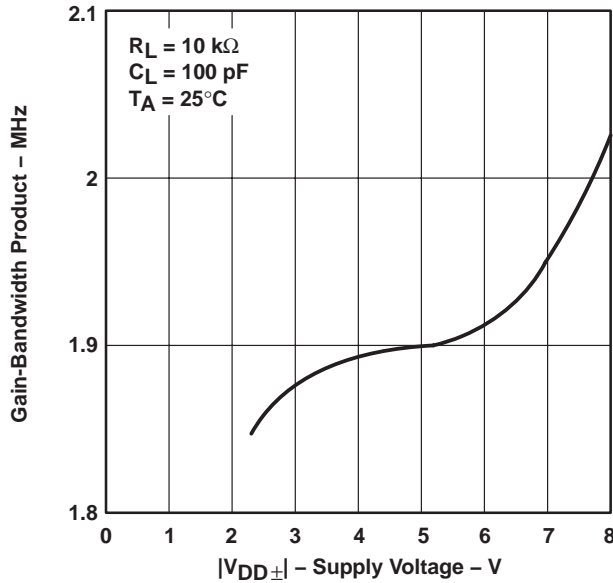


Figure 33

TLC2202  
GAIN-BANDWIDTH PRODUCT  
vs  
SUPPLY VOLTAGE

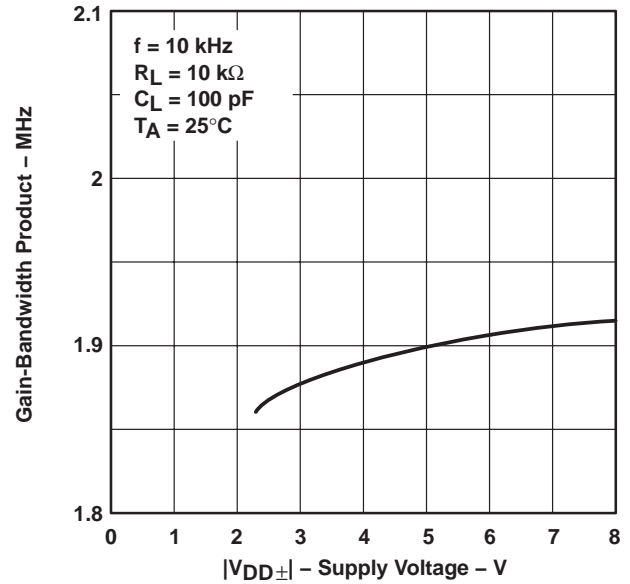


Figure 34

GAIN-BANDWIDTH PRODUCT†  
vs  
FREE-AIR TEMPERATURE

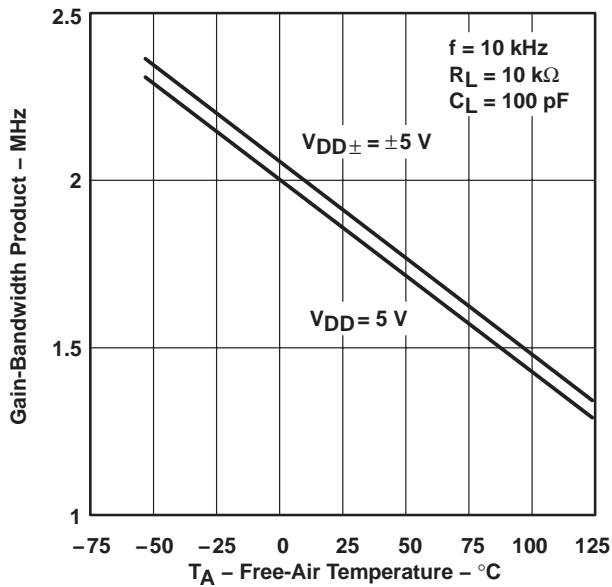


Figure 35

TLC2201  
PHASE MARGIN  
vs  
SUPPLY VOLTAGE

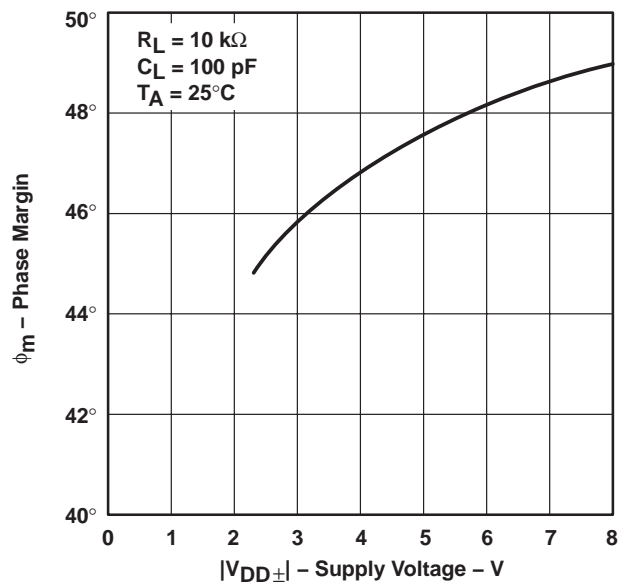


Figure 36

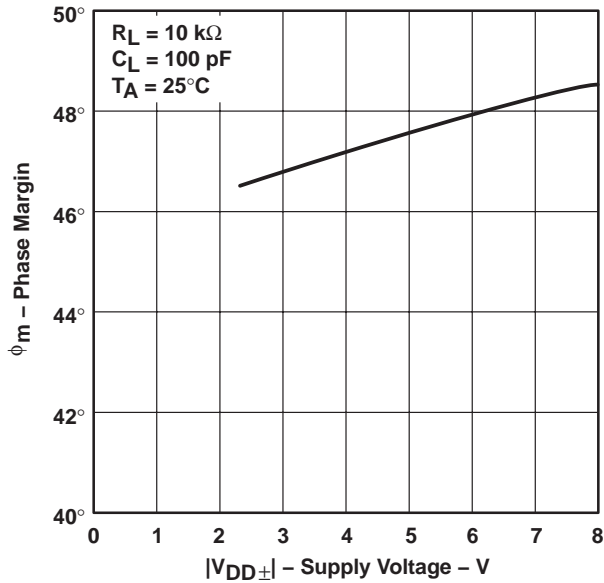
† Data at high and low temperatures are applicable only within the rated operating free-air temperature ranges of the various devices.

**TLC220x, TLC220xA, TLC220xB, TLC220xY**  
**Advanced LinCMOS™ LOW-NOISE PRECISION**  
**OPERATIONAL AMPLIFIERS**

SLOS175B – FEBRUARY 1997 – REVISED JANUARY 2008

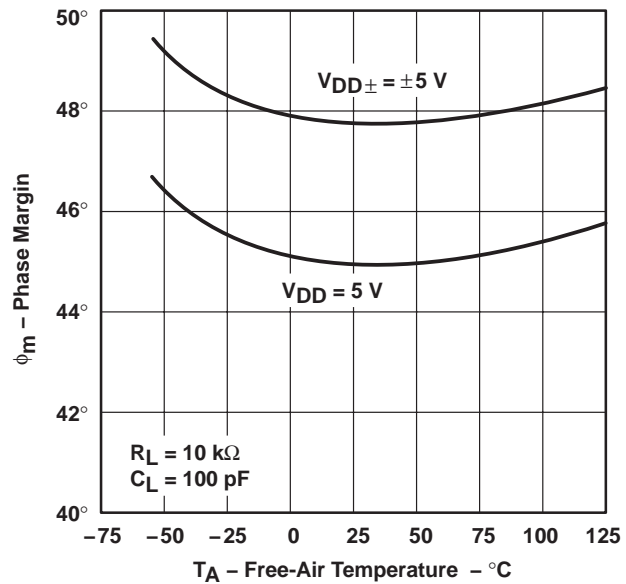
**TYPICAL CHARACTERISTICS**

**TLC2202**  
**PHASE MARGIN**  
**vs**  
**SUPPLY VOLTAGE**



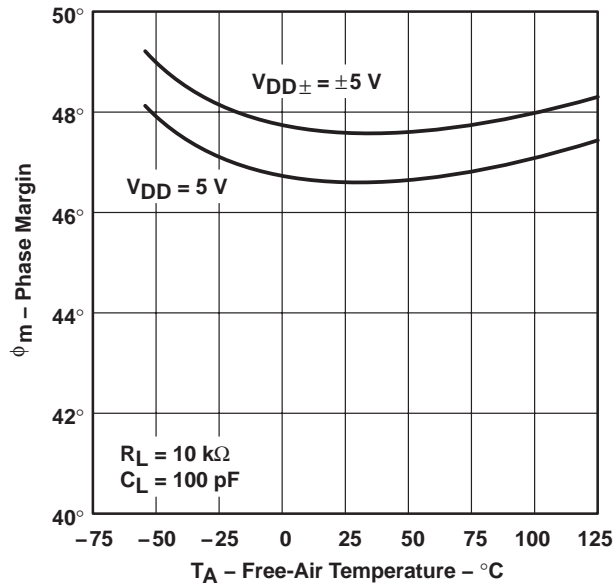
**Figure 37**

**TLC2201**  
**PHASE MARGIN†**  
**vs**  
**FREE-AIR TEMPERATURE**



**Figure 38**

**TLC2202**  
**PHASE MARGIN†**  
**vs**  
**FREE-AIR TEMPERATURE**



**Figure 39**

† Data at high and low temperatures are applicable only within the rated operating free-air temperature ranges of the various devices.

---

## APPLICATION INFORMATION

### latch-up avoidance

Because CMOS devices are susceptible to latch-up due to their inherent parasitic thyristors, the TLC220x, TLC220xA, and TLC220xB inputs and outputs are designed to withstand –100-mA surge currents without sustaining latch-up; however, techniques reducing the chance of latch-up should be used whenever possible. Internal protection diodes should not be forward biased in normal operation. Applied input and output voltages should not exceed the supply voltage by more than 300 mV. Care should be exercised when using capacitive coupling on pulse generators. Supply transients should be shunted by the use of decoupling capacitors (0.1  $\mu$ F typical) located across the supply rails as close to the device as possible.

### electrostatic discharge protection

These devices use internal ESD-protection circuits that prevent functional failures at voltages at or below 2000 V. Care should be exercised in handling these devices as exposure to ESD may result in degradation of the device parametric performance.

### macromodel information

Macromodel information provided was derived using Microsim *Parts*™, the model generation software used with Microsim *PSpice*™. The Boyle macromodel (see Note 5) and subcircuit in Figure 40 were generated using the TLC220x typical electrical and operating characteristics at 25°C. Using this information, output simulations of the following key parameters can be generated to a tolerance of 20% (in most cases):

- Maximum positive output voltage swing
- Maximum negative output voltage swing
- Slew rate
- Quiescent power dissipation
- Input bias current
- Open-loop voltage amplification
- Unity-gain frequency
- Common-mode rejection ratio
- Phase margin
- DC output resistance
- AC output resistance
- Short-circuit output current limit

NOTE 5: G. R. Boyle, B. M. Cohn, D. O. Pederson, and J. E. Solomon, "Macromodeling of Integrated Circuit Operational Amplifiers", *IEEE Journal of Solid-State Circuits*, SC-9, 353 (1974).

*PSpice* and *Parts* are trademarks of MicroSim Corporation.

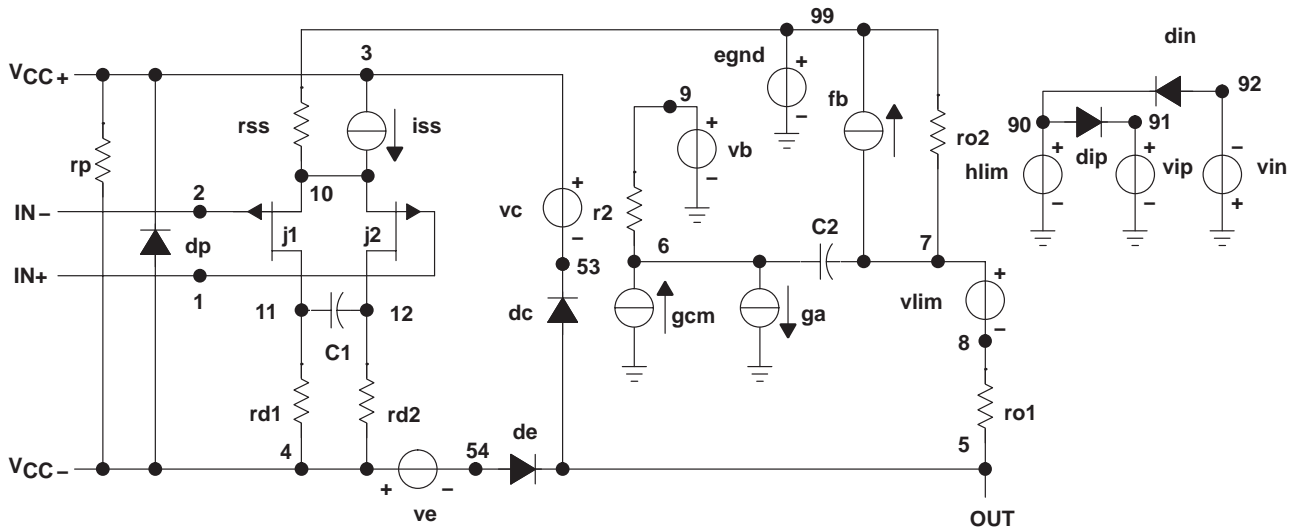
---

**TLC220x, TLC220xA, TLC220xB, TLC220xY**  
**Advanced LinCMOS™ LOW-NOISE PRECISION**  
**OPERATIONAL AMPLIFIERS**

SLOS175B – FEBRUARY 1997 – REVISED JANUARY 2008

**APPLICATION INFORMATION**

**macromodel information (continued)**



```
.subckt TLC220x 1 2 3 4 5
*
c1 11 12 8.51E-12
c2 6 7 50.00E-12
cpsr 85 86 79.6E-9
dcm+ 81 82 dx
dcm- 83 81 dx
dc 5 53 dx
de 54 5 dx
dlp 90 91 dx
dln 92 90 dx
dp 4 3 dx
ecmr 84 99 (2,99) 1
egnd 99 0 poly(2) (3,0) (4,0) 0 .5 .5
epsr 85 0 poly(1) (3,4) -200E-6 20E-6
ense 89 2 poly(1) (88,0) 100E-6 1
fb 7 99 poly(6) vb vc ve vlp vln
+ vpsr 0 + 895.9E3 -90E3 90E3 90E3 -90E3 895E3
ga 6 0 11 12 314.2E-6
gcm 0 6 10 99 1.295E-9
gpsr 85 86 (85,86) 100E-6
grd1 60 11 (60,11) 3.141E-4
grd2 60 12 (60,12) 3.141E-4
hlim 90 0 vlim 1k
hcmr 80 1 poly(2) vcm+ vcm- 0 1E2 1E2
irp 3 4 965E-6
iss 3 10 dc 135.0E-6
iio 2 0 .5E-12
i1 88 0 1E-21
j1 11 89 10 jx
j2 12 80 10 jx
rcm 84 81 1k
rn1 88 0 1500
ro1 8 5 188
ro2 7 99 187
rss 10 99 1.481E6
vad 60 4 -.3v
vcm+ 82 99 2.2
vcm- 83 99 -4.5
vb 9 0 dc 0
vc 3 53 dc .9
ve 54 4 dc .8
vlim 7 8 dc 0
vlp 91 0 dc 2.8
vln 0 92 dc 2.8
vpsr 0 86 dc 0
.model dx d(is=800.0E-18)
.model jx pjf(is=500.0E-15 beta=1.462E-3
+ vto=-.155 kf=1E-17)
.endsx
```

**Figure 40. Boyle Macromodel and Subcircuit**

**PACKAGING INFORMATION**

Orderable Device	Status <sup>(1)</sup>	Package Type	Package Drawing	Pins	Package Qty	Eco Plan <sup>(2)</sup>	Lead/ Ball Finish	MSL Peak Temp <sup>(3)</sup>	Samples (Requires Login)
5962-9088201M2A	ACTIVE	LCCC	FK	20	1	TBD	POST-PLATE	N / A for Pkg Type	<a href="#">Purchase Samples</a>
5962-9088201MPA	ACTIVE	CDIP	JG	8	1	TBD	A42	N / A for Pkg Type	Contact TI Distributor or Sales Office
5962-9088202M2A	ACTIVE	LCCC	FK	20	1	TBD	POST-PLATE	N / A for Pkg Type	Contact TI Distributor or Sales Office
5962-9088202MPA	ACTIVE	CDIP	JG	8	1	TBD	A42	N / A for Pkg Type	Contact TI Distributor or Sales Office
5962-9088203Q2A	ACTIVE	LCCC	FK	20	1	TBD	POST-PLATE	N / A for Pkg Type	<a href="#">Purchase Samples</a>
5962-9088203QPA	ACTIVE	CDIP	JG	8	1	TBD	A42	N / A for Pkg Type	<a href="#">Purchase Samples</a>
5962-9088204Q2A	ACTIVE	LCCC	FK	20	1	TBD	POST-PLATE	N / A for Pkg Type	Contact TI Distributor or Sales Office
5962-9088204QPA	ACTIVE	CDIP	JG	8	1	TBD	A42	N / A for Pkg Type	Contact TI Distributor or Sales Office
TLC2201AMD	ACTIVE	SOIC	D	8	75	TBD	CU NIPDAU	Level-1-220C-UNLIM	<a href="#">Request Free Samples</a>
TLC2201AMDG4	ACTIVE	SOIC	D	8	75	Green (RoHS & no Sb/Br)	CU NIPDAU	Level-1-260C-UNLIM	<a href="#">Purchase Samples</a>
TLC2201AMFKB	ACTIVE	LCCC	FK	20	1	TBD	POST-PLATE	N / A for Pkg Type	Contact TI Distributor or Sales Office
TLC2201AMJG	ACTIVE	CDIP	JG	8	1	TBD	A42	N / A for Pkg Type	Contact TI Distributor or Sales Office
TLC2201AMJGB	ACTIVE	CDIP	JG	8	1	TBD	A42	N / A for Pkg Type	Contact TI Distributor or Sales Office
TLC2201AMP	OBSOLETE	PDIP	P	8		TBD	Call TI	Call TI	Samples Not Available
TLC2201CD	ACTIVE	SOIC	D	8	75	Green (RoHS & no Sb/Br)	CU NIPDAU	Level-1-260C-UNLIM	<a href="#">Request Free Samples</a>
TLC2201CDG4	ACTIVE	SOIC	D	8	75	Green (RoHS & no Sb/Br)	CU NIPDAU	Level-1-260C-UNLIM	<a href="#">Request Free Samples</a>
TLC2201CDR	ACTIVE	SOIC	D	8	2500	Green (RoHS & no Sb/Br)	CU NIPDAU	Level-1-260C-UNLIM	<a href="#">Purchase Samples</a>
TLC2201CDRG4	ACTIVE	SOIC	D	8	2500	Green (RoHS & no Sb/Br)	CU NIPDAU	Level-1-260C-UNLIM	<a href="#">Purchase Samples</a>
TLC2201CP	ACTIVE	PDIP	P	8	50	Pb-Free (RoHS)	CU NIPDAU	N / A for Pkg Type	<a href="#">Request Free Samples</a>
TLC2201CPE4	ACTIVE	PDIP	P	8	50	Pb-Free (RoHS)	CU NIPDAU	N / A for Pkg Type	<a href="#">Request Free Samples</a>

Orderable Device	Status <sup>(1)</sup>	Package Type	Package Drawing	Pins	Package Qty	Eco Plan <sup>(2)</sup>	Lead/ Ball Finish	MSL Peak Temp <sup>(3)</sup>	Samples (Requires Login)
TLC2201CPSR	OBSOLETE	SO	PS	8		TBD	Call TI	Call TI	Samples Not Available
TLC2201ID	ACTIVE	SOIC	D	8	75	Green (RoHS & no Sb/Br)	CU NIPDAU	Level-1-260C-UNLIM	<a href="#">Purchase Samples</a>
TLC2201IDG4	ACTIVE	SOIC	D	8	75	Green (RoHS & no Sb/Br)	CU NIPDAU	Level-1-260C-UNLIM	<a href="#">Purchase Samples</a>
TLC2201IDR	ACTIVE	SOIC	D	8	2500	Green (RoHS & no Sb/Br)	CU NIPDAU	Level-1-260C-UNLIM	<a href="#">Request Free Samples</a>
TLC2201IDRG4	ACTIVE	SOIC	D	8	2500	Green (RoHS & no Sb/Br)	CU NIPDAU	Level-1-260C-UNLIM	<a href="#">Request Free Samples</a>
TLC2201IP	ACTIVE	PDIP	P	8	50	Pb-Free (RoHS)	CU NIPDAU	N / A for Pkg Type	<a href="#">Request Free Samples</a>
TLC2201IPE4	ACTIVE	PDIP	P	8	50	Pb-Free (RoHS)	CU NIPDAU	N / A for Pkg Type	<a href="#">Request Free Samples</a>
TLC2201MFKB	ACTIVE	LCCC	FK	20	1	TBD	POST-PLATE	N / A for Pkg Type	Contact TI Distributor or Sales Office
TLC2201MJGB	ACTIVE	CDIP	JG	8	1	TBD	A42	N / A for Pkg Type	Contact TI Distributor or Sales Office
TLC2202AMFKB	ACTIVE	LCCC	FK	20	1	TBD	POST-PLATE	N / A for Pkg Type	Contact TI Distributor or Sales Office
TLC2202AMJG	ACTIVE	CDIP	JG	8	1	TBD	A42	N / A for Pkg Type	Contact TI Distributor or Sales Office
TLC2202AMJGB	ACTIVE	CDIP	JG	8	1	TBD	A42	N / A for Pkg Type	Contact TI Distributor or Sales Office
TLC2202CD	ACTIVE	SOIC	D	14	50	Green (RoHS & no Sb/Br)	CU NIPDAU	Level-1-260C-UNLIM	<a href="#">Request Free Samples</a>
TLC2202CDG4	ACTIVE	SOIC	D	14	50	Green (RoHS & no Sb/Br)	CU NIPDAU	Level-1-260C-UNLIM	<a href="#">Request Free Samples</a>
TLC2202CDR	ACTIVE	SOIC	D	14	2500	Green (RoHS & no Sb/Br)	CU NIPDAU	Level-1-260C-UNLIM	<a href="#">Purchase Samples</a>
TLC2202CDRG4	ACTIVE	SOIC	D	14	2500	Green (RoHS & no Sb/Br)	CU NIPDAU	Level-1-260C-UNLIM	<a href="#">Purchase Samples</a>
TLC2202CP	ACTIVE	PDIP	P	8	50	Pb-Free (RoHS)	CU NIPDAU	N / A for Pkg Type	<a href="#">Request Free Samples</a>
TLC2202CPE4	ACTIVE	PDIP	P	8	50	Pb-Free (RoHS)	CU NIPDAU	N / A for Pkg Type	<a href="#">Request Free Samples</a>
TLC2202CPSR	ACTIVE	SO	PS	8	2000	Green (RoHS & no Sb/Br)	CU NIPDAU	Level-1-260C-UNLIM	<a href="#">Purchase Samples</a>
TLC2202CPSRG4	ACTIVE	SO	PS	8	2000	Green (RoHS & no Sb/Br)	CU NIPDAU	Level-1-260C-UNLIM	<a href="#">Purchase Samples</a>



Orderable Device	Status <sup>(1)</sup>	Package Type	Package Drawing	Pins	Package Qty	Eco Plan <sup>(2)</sup>	Lead/ Ball Finish	MSL Peak Temp <sup>(3)</sup>	Samples (Requires Login)
TLC2202ID	ACTIVE	SOIC	D	14	50	Green (RoHS & no Sb/Br)	CU NIPDAU	Level-1-260C-UNLIM	<a href="#">Request Free Samples</a>
TLC2202IDG4	ACTIVE	SOIC	D	14	50	Green (RoHS & no Sb/Br)	CU NIPDAU	Level-1-260C-UNLIM	<a href="#">Request Free Samples</a>
TLC2202IP	ACTIVE	PDIP	P	8	50	Pb-Free (RoHS)	CU NIPDAU	N / A for Pkg Type	<a href="#">Request Free Samples</a>
TLC2202IPE4	ACTIVE	PDIP	P	8	50	Pb-Free (RoHS)	CU NIPDAU	N / A for Pkg Type	<a href="#">Request Free Samples</a>
TLC2202MFKB	ACTIVE	LCCC	FK	20	1	TBD	POST-PLATE	N / A for Pkg Type	Contact TI Distributor or Sales Office
TLC2202MJG	ACTIVE	CDIP	JG	8	1	TBD	A42	N / A for Pkg Type	Contact TI Distributor or Sales Office
TLC2202MJGB	ACTIVE	CDIP	JG	8	1	TBD	A42	N / A for Pkg Type	Contact TI Distributor or Sales Office

<sup>(1)</sup> The marketing status values are defined as follows:

**ACTIVE:** Product device recommended for new designs.

**LIFEBUY:** TI has announced that the device will be discontinued, and a lifetime-buy period is in effect.

**NRND:** Not recommended for new designs. Device is in production to support existing customers, but TI does not recommend using this part in a new design.

**PREVIEW:** Device has been announced but is not in production. Samples may or may not be available.

**OBSOLETE:** TI has discontinued the production of the device.

<sup>(2)</sup> Eco Plan - The planned eco-friendly classification: Pb-Free (RoHS), Pb-Free (RoHS Exempt), or Green (RoHS & no Sb/Br) - please check <http://www.ti.com/productcontent> for the latest availability information and additional product content details.

**TBD:** The Pb-Free/Green conversion plan has not been defined.

**Pb-Free (RoHS):** TI's terms "Lead-Free" or "Pb-Free" mean semiconductor products that are compatible with the current RoHS requirements for all 6 substances, including the requirement that lead not exceed 0.1% by weight in homogeneous materials. Where designed to be soldered at high temperatures, TI Pb-Free products are suitable for use in specified lead-free processes.

**Pb-Free (RoHS Exempt):** This component has a RoHS exemption for either 1) lead-based flip-chip solder bumps used between the die and package, or 2) lead-based die adhesive used between the die and leadframe. The component is otherwise considered Pb-Free (RoHS compatible) as defined above.

**Green (RoHS & no Sb/Br):** TI defines "Green" to mean Pb-Free (RoHS compatible), and free of Bromine (Br) and Antimony (Sb) based flame retardants (Br or Sb do not exceed 0.1% by weight in homogeneous material)

<sup>(3)</sup> MSL, Peak Temp. -- The Moisture Sensitivity Level rating according to the JEDEC industry standard classifications, and peak solder temperature.

**Important Information and Disclaimer:** The information provided on this page represents TI's knowledge and belief as of the date that it is provided. TI bases its knowledge and belief on information provided by third parties, and makes no representation or warranty as to the accuracy of such information. Efforts are underway to better integrate information from third parties. TI has taken and continues to take reasonable steps to provide representative and accurate information but may not have conducted destructive testing or chemical analysis on incoming materials and chemicals. TI and TI suppliers consider certain information to be proprietary, and thus CAS numbers and other limited information may not be available for release.

In no event shall TI's liability arising out of such information exceed the total purchase price of the TI part(s) at issue in this document sold by TI to Customer on an annual basis.

**OTHER QUALIFIED VERSIONS OF TLC2201, TLC2201AM, TLC2201M, TLC2202, TLC2202AM, TLC2202M :**

● Catalog: [TLC2201A](#), [TLC2201](#), [TLC2202A](#), [TLC2202](#)

● Military: [TLC2201M](#), [TLC2202M](#)

NOTE: Qualified Version Definitions:

- Catalog - TI's standard catalog product
- Military - QML certified for Military and Defense Applications

**TAPE AND REEL INFORMATION**

**QUADRANT ASSIGNMENTS FOR PIN 1 ORIENTATION IN TAPE**


\*All dimensions are nominal

Device	Package Type	Package Drawing	Pins	SPQ	Reel Diameter (mm)	Reel Width W1 (mm)	A0 (mm)	B0 (mm)	K0 (mm)	P1 (mm)	W (mm)	Pin1 Quadrant
TLC2201CDR	SOIC	D	8	2500	330.0	12.4	6.4	5.2	2.1	8.0	12.0	Q1
TLC2201IDR	SOIC	D	8	2500	330.0	12.4	6.4	5.2	2.1	8.0	12.0	Q1
TLC2202CDR	SOIC	D	14	2500	330.0	16.4	6.5	9.0	2.1	8.0	16.0	Q1
TLC2202CPSR	SO	PS	8	2000	330.0	16.4	8.2	6.6	2.5	12.0	16.0	Q1

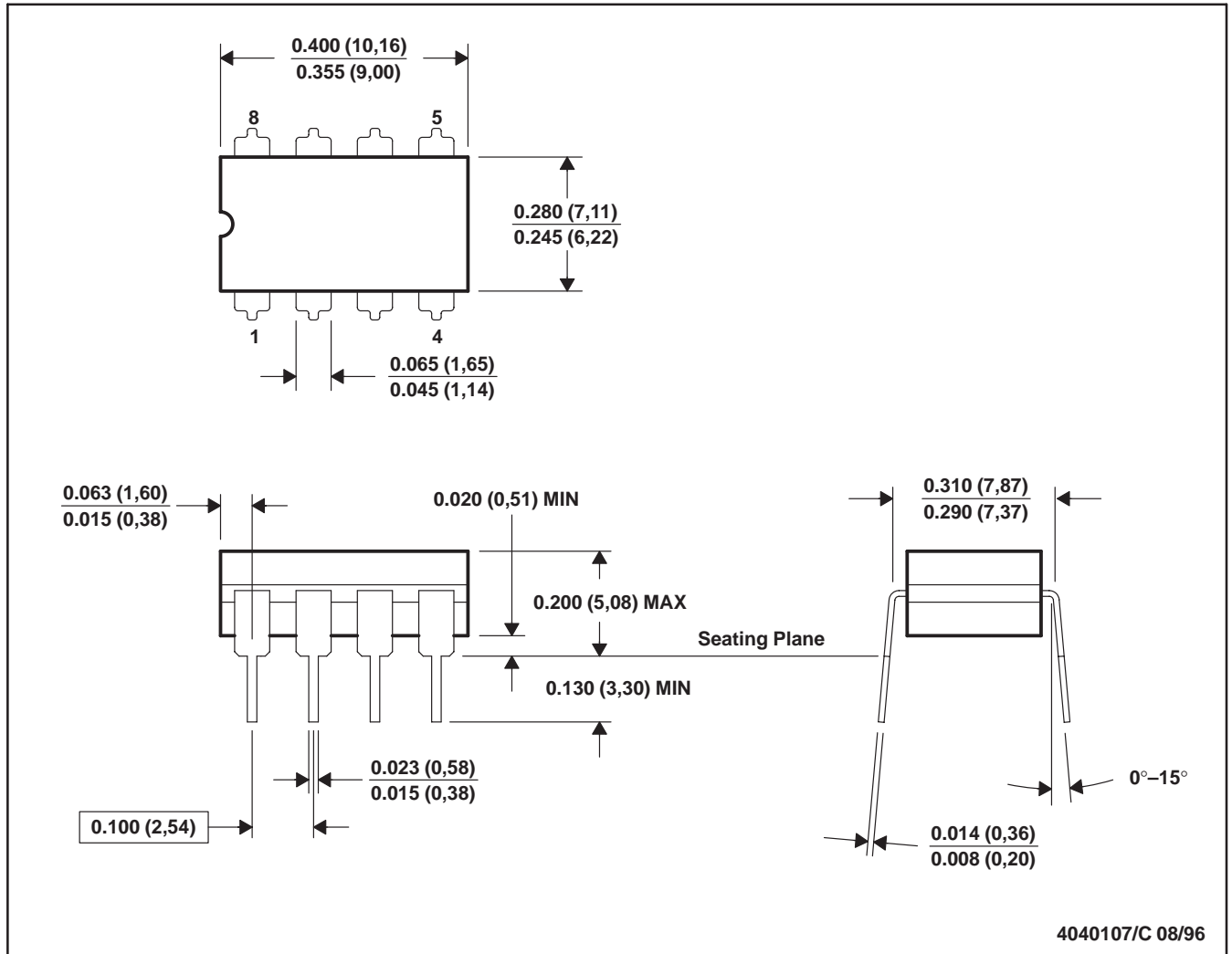
**TAPE AND REEL BOX DIMENSIONS**


\*All dimensions are nominal

Device	Package Type	Package Drawing	Pins	SPQ	Length (mm)	Width (mm)	Height (mm)
TLC2201CDR	SOIC	D	8	2500	340.5	338.1	20.6
TLC2201IDR	SOIC	D	8	2500	340.5	338.1	20.6
TLC2202CDR	SOIC	D	14	2500	346.0	346.0	33.0
TLC2202CPSR	SO	PS	8	2000	346.0	346.0	33.0

JG (R-GDIP-T8)

CERAMIC DUAL-IN-LINE

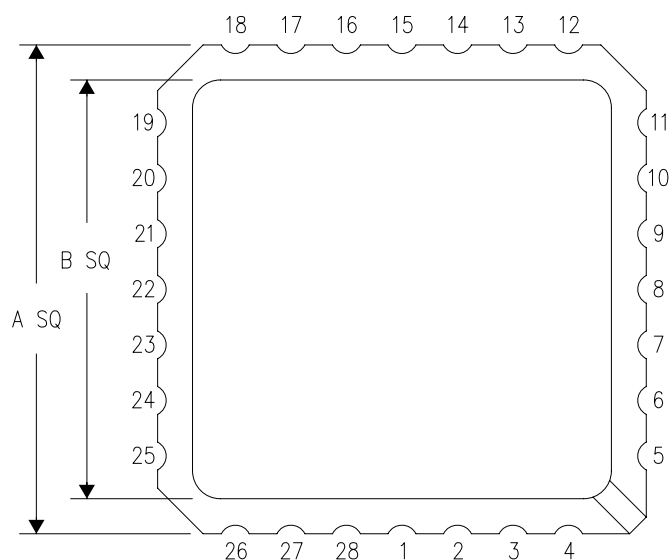


- NOTES: A. All linear dimensions are in inches (millimeters).  
 B. This drawing is subject to change without notice.  
 C. This package can be hermetically sealed with a ceramic lid using glass frit.  
 D. Index point is provided on cap for terminal identification.  
 E. Falls within MIL STD 1835 GDIP1-T8

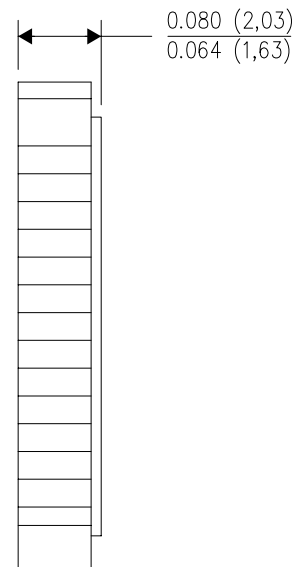
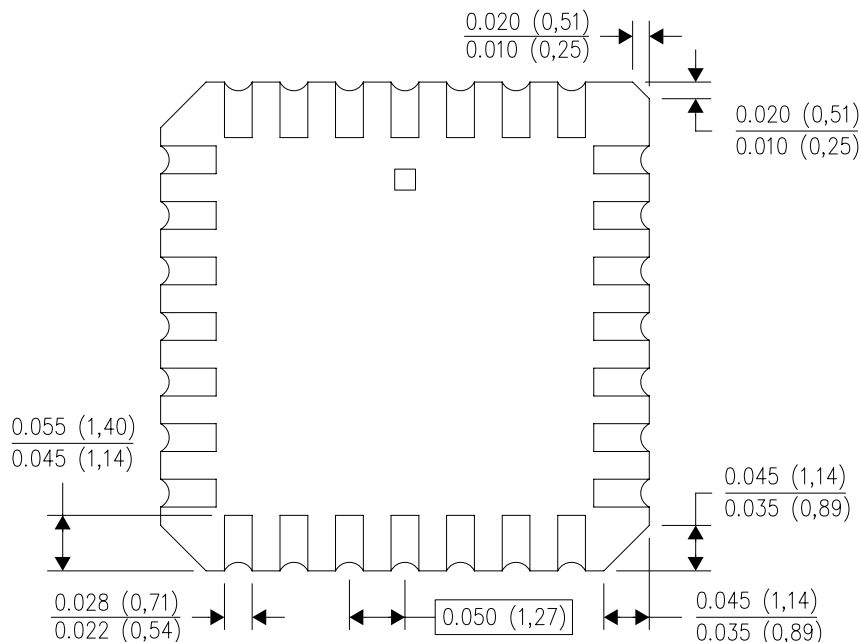
FK (S-CQCC-N\*\*)

LEADLESS CERAMIC CHIP CARRIER

28 TERMINAL SHOWN



NO. OF TERMINALS **	A		B	
	MIN	MAX	MIN	MAX
20	0.342 (8,69)	0.358 (9,09)	0.307 (7,80)	0.358 (9,09)
28	0.442 (11,23)	0.458 (11,63)	0.406 (10,31)	0.458 (11,63)
44	0.640 (16,26)	0.660 (16,76)	0.495 (12,58)	0.560 (14,22)
52	0.740 (18,78)	0.761 (19,32)	0.495 (12,58)	0.560 (14,22)
68	0.938 (23,83)	0.962 (24,43)	0.850 (21,6)	0.858 (21,8)
84	1.141 (28,99)	1.165 (29,59)	1.047 (26,6)	1.063 (27,0)

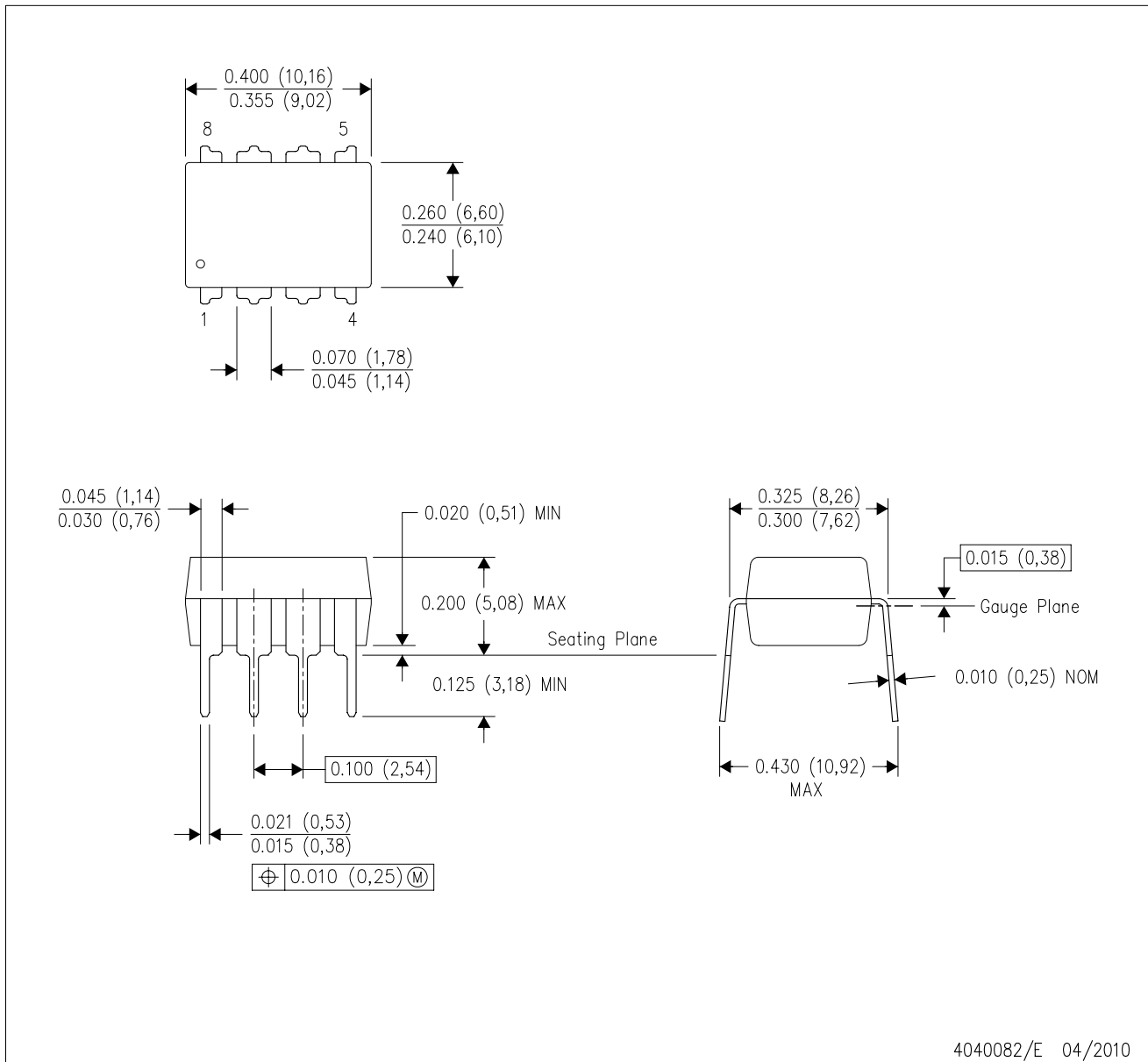


4040140/D 01/11

- NOTES:
- All linear dimensions are in inches (millimeters).
  - This drawing is subject to change without notice.
  - This package can be hermetically sealed with a metal lid.
  - Falls within JEDEC MS-004

P (R-PDIP-T8)

PLASTIC DUAL-IN-LINE PACKAGE

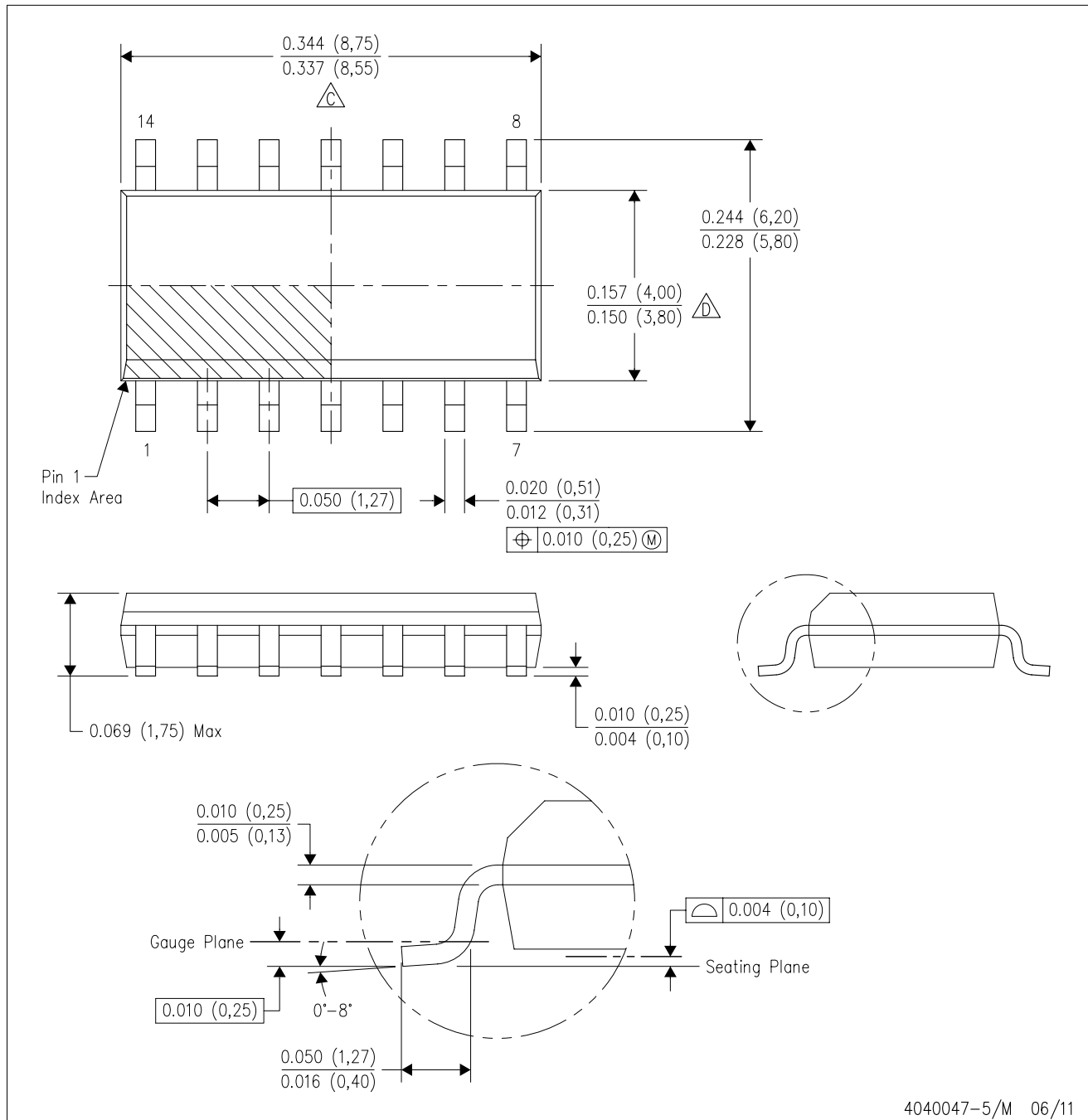




4040082/E 04/2010

- NOTES:
- A. All linear dimensions are in inches (millimeters).
  - B. This drawing is subject to change without notice.
  - C. Falls within JEDEC MS-001 variation BA.

D (R-PDSO-G14)

PLASTIC SMALL OUTLINE

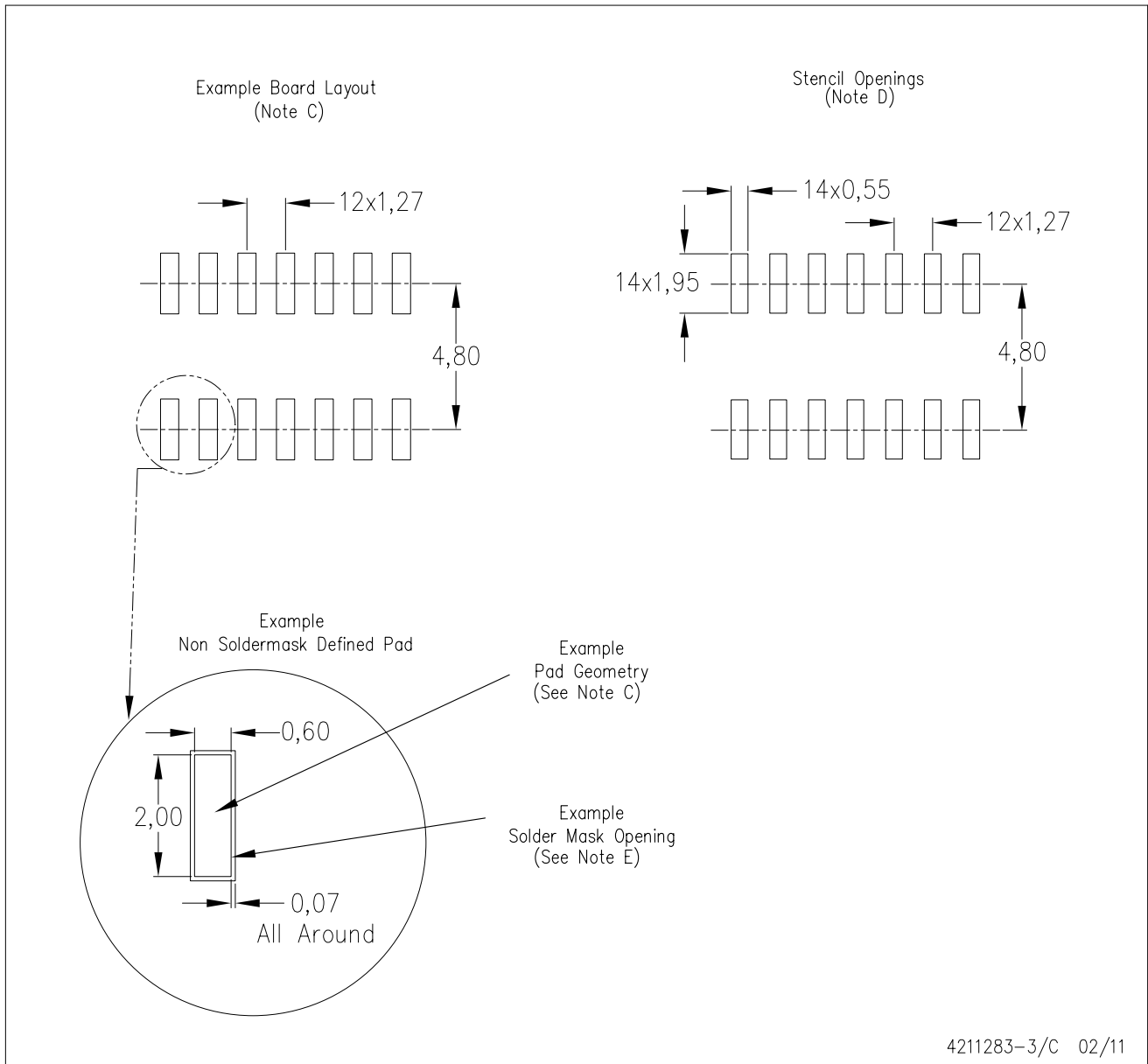


- NOTES:
- A. All linear dimensions are in inches (millimeters).
  - B. This drawing is subject to change without notice.
  -  C. Body length does not include mold flash, protrusions, or gate burrs. Mold flash, protrusions, or gate burrs shall not exceed 0.006 (0,15) each side.
  -  D. Body width does not include interlead flash. Interlead flash shall not exceed 0.017 (0,43) each side.
  - E. Reference JEDEC MS-012 variation AB.



D (R-PDSO-G14)

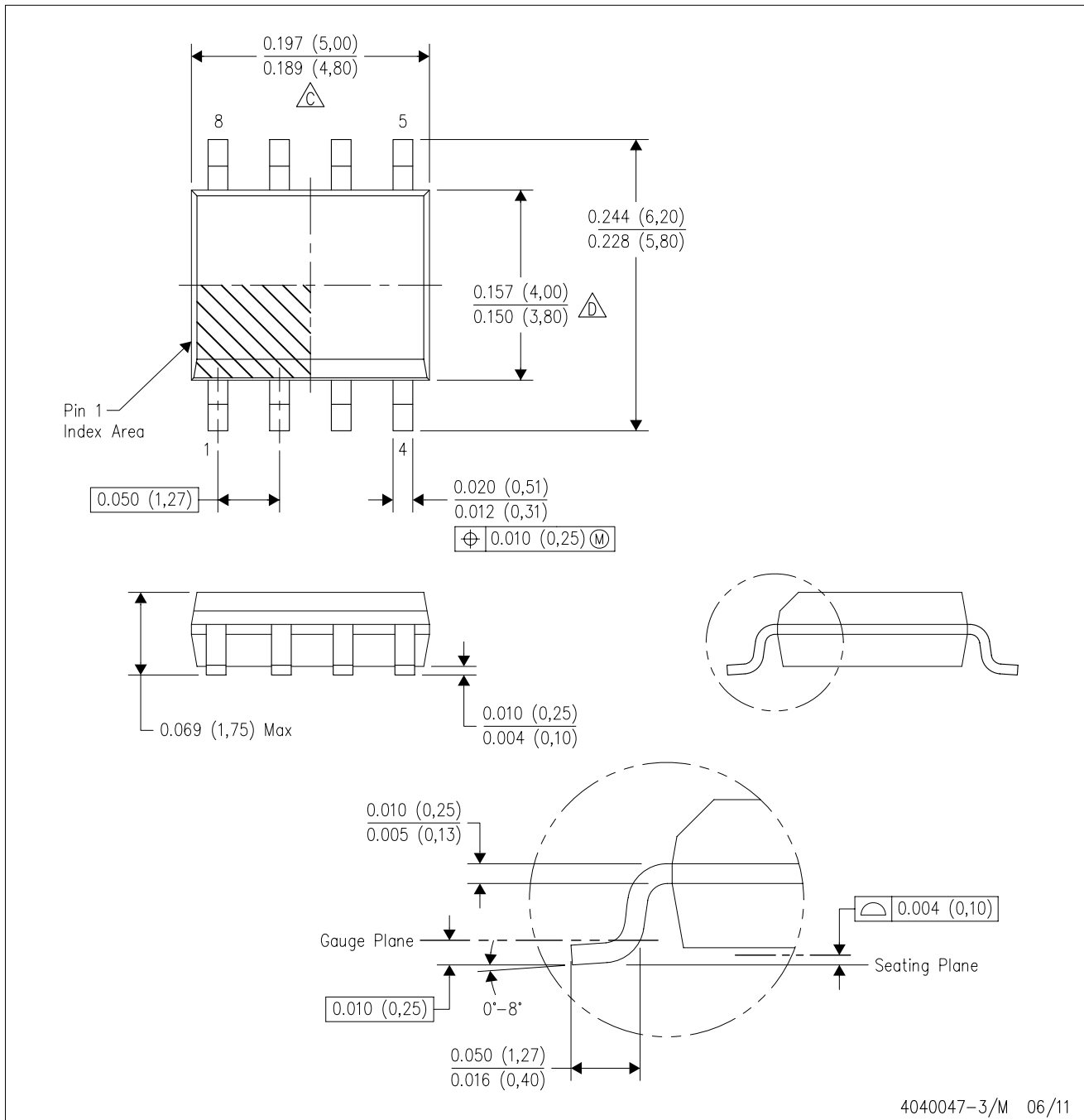
PLASTIC SMALL OUTLINE





- NOTES:
- A. All linear dimensions are in millimeters.
  - B. This drawing is subject to change without notice.
  - C. Publication IPC-7351 is recommended for alternate designs.
  - D. Laser cutting apertures with trapezoidal walls and also rounding corners will offer better paste release. Customers should contact their board assembly site for stencil design recommendations. Refer to IPC-7525 for other stencil recommendations.
  - E. Customers should contact their board fabrication site for solder mask tolerances between and around signal pads.

D (R-PDSO-G8)

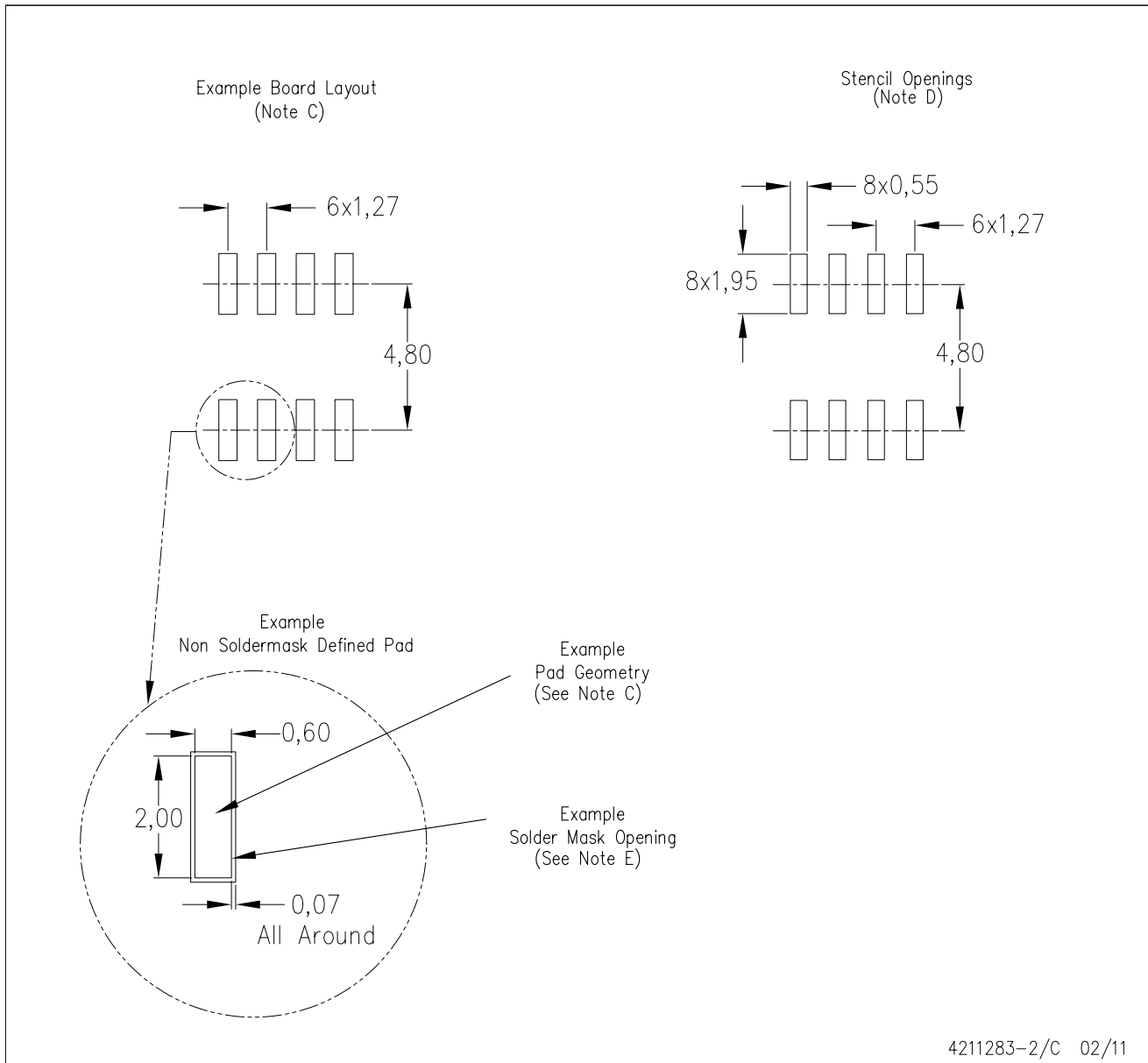
PLASTIC SMALL OUTLINE



- NOTES:
- A. All linear dimensions are in inches (millimeters).
  - B. This drawing is subject to change without notice.
  -  Body length does not include mold flash, protrusions, or gate burrs. Mold flash, protrusions, or gate burrs shall not exceed 0.006 (0,15) each side.
  -  Body width does not include interlead flash. Interlead flash shall not exceed 0.017 (0,43) each side.
  - E. Reference JEDEC MS-012 variation AA.

D (R-PDSO-G8)

PLASTIC SMALL OUTLINE

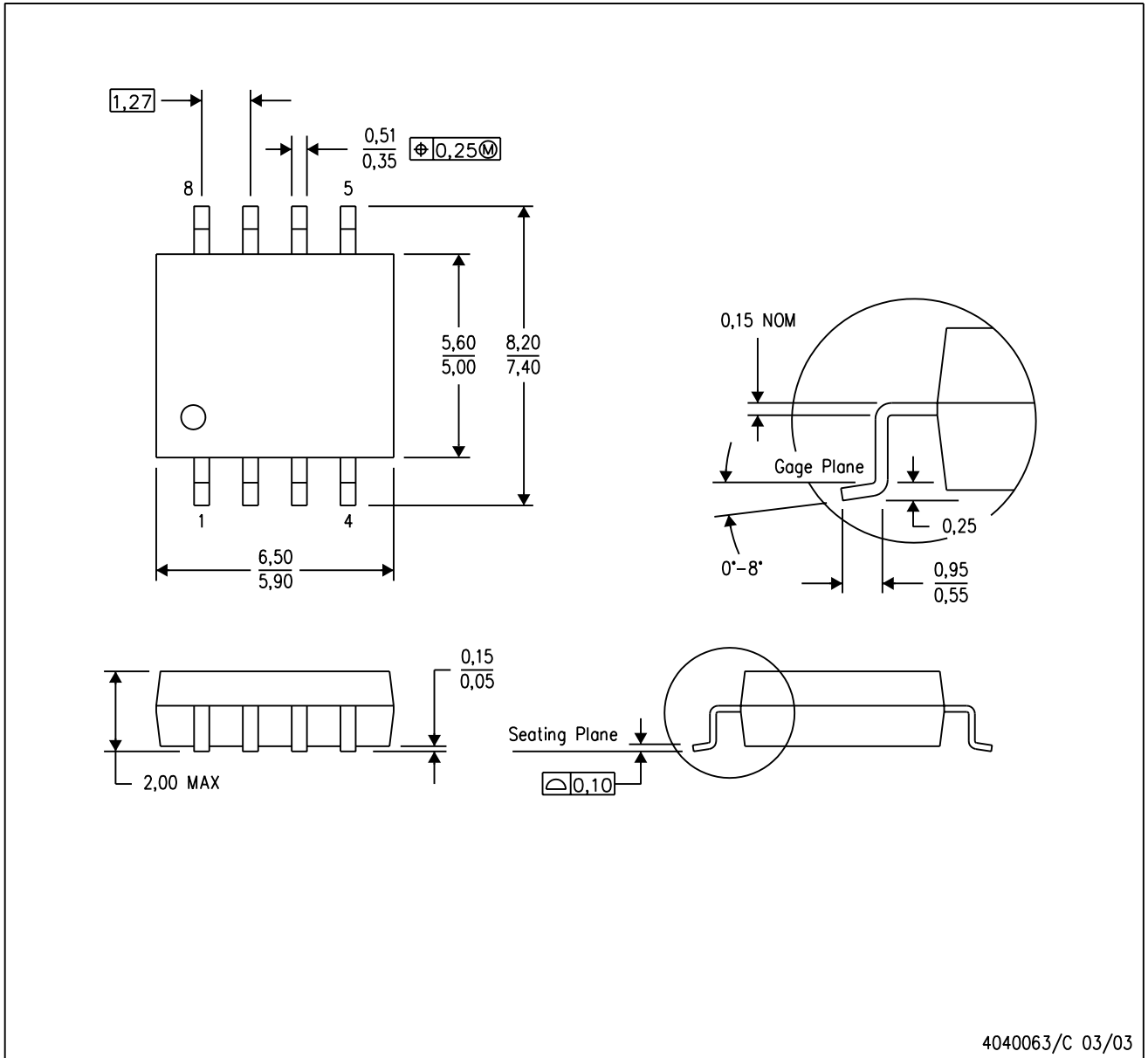


- NOTES:
- All linear dimensions are in millimeters.
  - This drawing is subject to change without notice.
  - Publication IPC-7351 is recommended for alternate designs.
  - Laser cutting apertures with trapezoidal walls and also rounding corners will offer better paste release. Customers should contact their board assembly site for stencil design recommendations. Refer to IPC-7525 for other stencil recommendations.
  - Customers should contact their board fabrication site for solder mask tolerances between and around signal pads.

MECHANICAL DATA

PS (R-PDSO-G8)

PLASTIC SMALL-OUTLINE PACKAGE



- NOTES:
- A. All linear dimensions are in millimeters.
  - B. This drawing is subject to change without notice.
  - C. Body dimensions do not include mold flash or protrusion, not to exceed 0,15.

## IMPORTANT NOTICE

Texas Instruments Incorporated and its subsidiaries (TI) reserve the right to make corrections, modifications, enhancements, improvements, and other changes to its products and services at any time and to discontinue any product or service without notice. Customers should obtain the latest relevant information before placing orders and should verify that such information is current and complete. All products are sold subject to TI's terms and conditions of sale supplied at the time of order acknowledgment.

TI warrants performance of its hardware products to the specifications applicable at the time of sale in accordance with TI's standard warranty. Testing and other quality control techniques are used to the extent TI deems necessary to support this warranty. Except where mandated by government requirements, testing of all parameters of each product is not necessarily performed.

TI assumes no liability for applications assistance or customer product design. Customers are responsible for their products and applications using TI components. To minimize the risks associated with customer products and applications, customers should provide adequate design and operating safeguards.

TI does not warrant or represent that any license, either express or implied, is granted under any TI patent right, copyright, mask work right, or other TI intellectual property right relating to any combination, machine, or process in which TI products or services are used. Information published by TI regarding third-party products or services does not constitute a license from TI to use such products or services or a warranty or endorsement thereof. Use of such information may require a license from a third party under the patents or other intellectual property of the third party, or a license from TI under the patents or other intellectual property of TI.

Reproduction of TI information in TI data books or data sheets is permissible only if reproduction is without alteration and is accompanied by all associated warranties, conditions, limitations, and notices. Reproduction of this information with alteration is an unfair and deceptive business practice. TI is not responsible or liable for such altered documentation. Information of third parties may be subject to additional restrictions.

Resale of TI products or services with statements different from or beyond the parameters stated by TI for that product or service voids all express and any implied warranties for the associated TI product or service and is an unfair and deceptive business practice. TI is not responsible or liable for any such statements.

TI products are not authorized for use in safety-critical applications (such as life support) where a failure of the TI product would reasonably be expected to cause severe personal injury or death, unless officers of the parties have executed an agreement specifically governing such use. Buyers represent that they have all necessary expertise in the safety and regulatory ramifications of their applications, and acknowledge and agree that they are solely responsible for all legal, regulatory and safety-related requirements concerning their products and any use of TI products in such safety-critical applications, notwithstanding any applications-related information or support that may be provided by TI. Further, Buyers must fully indemnify TI and its representatives against any damages arising out of the use of TI products in such safety-critical applications.

TI products are neither designed nor intended for use in military/aerospace applications or environments unless the TI products are specifically designated by TI as military-grade or "enhanced plastic." Only products designated by TI as military-grade meet military specifications. Buyers acknowledge and agree that any such use of TI products which TI has not designated as military-grade is solely at the Buyer's risk, and that they are solely responsible for compliance with all legal and regulatory requirements in connection with such use.

TI products are neither designed nor intended for use in automotive applications or environments unless the specific TI products are designated by TI as compliant with ISO/TS 16949 requirements. Buyers acknowledge and agree that, if they use any non-designated products in automotive applications, TI will not be responsible for any failure to meet such requirements.

Following are URLs where you can obtain information on other Texas Instruments products and application solutions:

### Products

Audio	<a href="http://www.ti.com/audio">www.ti.com/audio</a>
Amplifiers	<a href="http://amplifier.ti.com">amplifier.ti.com</a>
Data Converters	<a href="http://dataconverter.ti.com">dataconverter.ti.com</a>
DLP® Products	<a href="http://www.dlp.com">www.dlp.com</a>
DSP	<a href="http://dsp.ti.com">dsp.ti.com</a>
Clocks and Timers	<a href="http://www.ti.com/clocks">www.ti.com/clocks</a>
Interface	<a href="http://interface.ti.com">interface.ti.com</a>
Logic	<a href="http://logic.ti.com">logic.ti.com</a>
Power Mgmt	<a href="http://power.ti.com">power.ti.com</a>
Microcontrollers	<a href="http://microcontroller.ti.com">microcontroller.ti.com</a>
RFID	<a href="http://www.ti-rfid.com">www.ti-rfid.com</a>
RF/IF and ZigBee® Solutions	<a href="http://www.ti.com/lprf">www.ti.com/lprf</a>

### Applications

Communications and Telecom	<a href="http://www.ti.com/communications">www.ti.com/communications</a>
Computers and Peripherals	<a href="http://www.ti.com/computers">www.ti.com/computers</a>
Consumer Electronics	<a href="http://www.ti.com/consumer-apps">www.ti.com/consumer-apps</a>
Energy and Lighting	<a href="http://www.ti.com/energy">www.ti.com/energy</a>
Industrial	<a href="http://www.ti.com/industrial">www.ti.com/industrial</a>
Medical	<a href="http://www.ti.com/medical">www.ti.com/medical</a>
Security	<a href="http://www.ti.com/security">www.ti.com/security</a>
Space, Avionics and Defense	<a href="http://www.ti.com/space-avionics-defense">www.ti.com/space-avionics-defense</a>
Transportation and Automotive	<a href="http://www.ti.com/automotive">www.ti.com/automotive</a>
Video and Imaging	<a href="http://www.ti.com/video">www.ti.com/video</a>
Wireless	<a href="http://www.ti.com/wireless-apps">www.ti.com/wireless-apps</a>

TI E2E Community Home Page

[e2e.ti.com](http://e2e.ti.com)

Mailing Address: Texas Instruments, Post Office Box 655303, Dallas, Texas 75265  
Copyright © 2011, Texas Instruments Incorporated

[www.BDTIC.com/TI](http://www.BDTIC.com/TI)