

TLC225x, TLC225xA
Advanced LinCMOS™ RAIL-TO-RAIL
VERY LOW-POWER OPERATIONAL AMPLIFIERS

SLOS176D – FEBRUARY 1997 – REVISED MARCH 2001

- **Output Swing Includes Both Supply Rails**
- **Low Noise . . . 19 nV/√Hz Typ at f = 1 kHz**
- **Low Input Bias Current . . . 1 pA Typ**
- **Fully Specified for Both Single-Supply and Split-Supply Operation**
- **Very Low Power . . . 35 μA Per Channel Typ**
- **Common-Mode Input Voltage Range Includes Negative Rail**
- **Low Input Offset Voltage**
850 μV Max at T_A = 25°C (TLC225xA)
- **Macromodel Included**
- **Performance Upgrades for the TS27L2/L4 and TLC27L2/L4**
- **Available in Q-Temp Automotive HighRel Automotive Applications Configuration Control / Print Support Qualification to Automotive Standards**

description

The TLC2252 and TLC2254 are dual and quadruple operational amplifiers from Texas Instruments. Both devices exhibit rail-to-rail output performance for increased dynamic range in single- or split-supply applications. The TLC225x family consumes only 35 μA of supply current per channel. This micropower operation makes them good choices for battery-powered applications. The noise performance has been dramatically improved over previous generations of CMOS amplifiers. Looking at Figure 1, the TLC225x has a noise level of 19 nV/√Hz at 1kHz; four times lower than competitive micropower solutions.

The TLC225x amplifiers, exhibiting high input impedance and low noise, are excellent for small-signal conditioning for high-impedance sources, such as piezoelectric transducers. Because of the micropower dissipation levels, these devices work well in hand-held monitoring and remote-sensing applications. In addition, the rail-to-rail output feature with single or split supplies makes this family a great choice when interfacing with analog-to-digital converters (ADCs). For precision applications, the TLC225xA family is available and has a maximum input offset voltage of 850 μV. This family is fully characterized at 5 V and ±5 V.

The TLC2252/4 also makes great upgrades to the TLC27L2/L4 or TS27L2/L4 in standard designs. They offer increased output dynamic range, lower noise voltage, and lower input offset voltage. This enhanced feature set allows them to be used in a wider range of applications. For applications that require higher output drive and wider input voltage ranges, see the TLV2432 and TLV2442 devices. If the design requires single amplifiers, please see the TLV2211/21/31 family. These devices are single rail-to-rail operational amplifiers in the SOT-23 package. Their small size and low power consumption, make them ideal for high density, battery-powered equipment.

**EQUIVALENT INPUT NOISE VOLTAGE
VS
FREQUENCY**

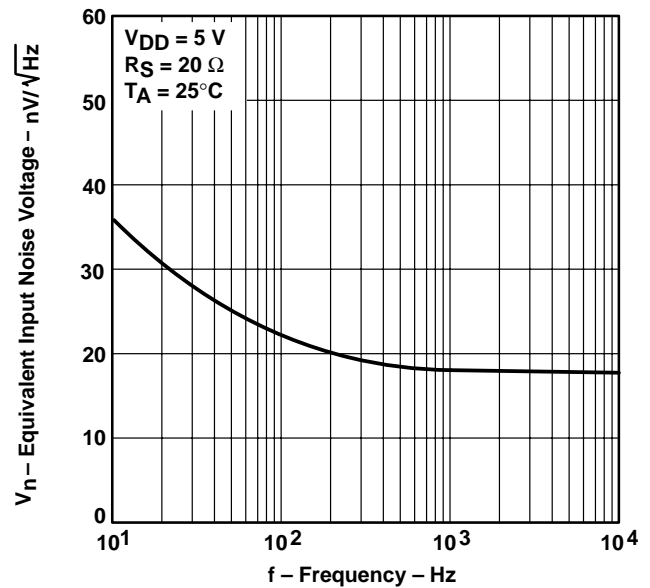

Figure 1



Please be aware that an important notice concerning availability, standard warranty, and use in critical applications of Texas Instruments semiconductor products and disclaimers thereto appears at the end of this data sheet.

Advanced LinCMOS is a trademark of Texas Instruments.

PRODUCTION DATA information is current as of publication date. Products conform to specifications per the terms of Texas Instruments standard warranty. Production processing does not necessarily include testing of all parameters.



www.BDITC.com/TI

POST OFFICE BOX 655303 • DALLAS, TEXAS 75265

Copyright © 2001, Texas Instruments Incorporated
 On products compliant to MIL-PRF-38535, all parameters are tested unless otherwise noted. On all other products, production processing does not necessarily include testing of all parameters.

TLC225x, TLC225xA
Advanced LinCMOS™ RAIL-TO-RAIL
VERY LOW-POWER OPERATIONAL AMPLIFIERS

SLOS176D – FEBRUARY 1997 – REVISED MARCH 2001

TLC2252 AVAILABLE OPTIONS

T _A	V _{IO} max AT 25°C	PACKAGED DEVICES					
		SMALL OUTLINE† (D)	CHIP CARRIER (FK)	CERAMIC DIP (JG)	PLASTIC DIP (P)	TSSOP‡ (PW)	CERAMIC FLATPACK (U)
0°C to 70°C	1500 μV	TLC2252CD	—	—	TLC2252CP	TLC2252CPW	—
–40°C to 125°C	850 μV 1500 μV	TLC2252AID TLC2252ID	— —	— —	TLC2252AIP TLC2252IP	TLC2252AIPW —	— —
–40°C to 125°C	850 μV 1500 μV	TLC2252AQD TLC2252QD	— —	— —	— —	— —	— —
–55°C to 125°C	850 μV 1500 μV	— —	TLC2252AMFK TLC2252MFK	TLC2252AMJG TLC2252MJG	— —	— —	TLC2252AMU TLC2252MU

† The D packages are available taped and reeled. Add R suffix to device type (e.g., TLC2262CDR).

‡ The PW package is available only left-ended taped and reeled.

§ Chip forms are tested at 25°C only.

TLC2254 AVAILABLE OPTIONS

T _A	V _{IO} max AT 25°C	PACKAGED DEVICES					
		SMALL OUTLINE† (D)	CHIP CARRIER (FK)	CERAMIC DIP (J)	PLASTIC DIP (N)	TSSOP‡ (PW)	CERAMIC FLATPACK (W)
0°C to 70°C	1500 μV	TLC2254CD	—	—	TLC2254CN	TLC2254CPW	—
–40°C to 125°C	850 μV 1500 μV	TLC2254AID TLC2254ID	— —	— —	TLC2254AIN TLC2254IN	TLC2254AIPW —	— —
–40°C to 125°C	850 μV 1500 μV	TLC2254AQD TLC2254QD	— —	— —	— —	— —	— —
–55°C to 125°C	850 μV 1500 μV	— —	TLC2254AMFK TLC2254MFK	TLC2254AMJ TLC2254MJ	— —	— —	TLC2254AMW TLC2254MW

† The D packages are available taped and reeled. Add R suffix to the device type (e.g., TLC2254CDR).

‡ The PW package is available only left-end taped and reeled. Chips are tested at 25°C.

§ Chip forms are tested at 25°C only.

TLC225x, TLC225xA
Advanced LinCMOS™ RAIL-TO-RAIL
VERY LOW-POWER OPERATIONAL AMPLIFIERS

SLOS176D – FEBRUARY 1997 – REVISED MARCH 2001

TLC2252C, TLC2252AC
TLC2252I, TLC2252AI
TLC2252Q, TLC2252AQ
D, P, OR PW PACKAGE
(TOP VIEW)

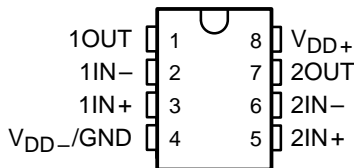

TLC2252M, TLC2252AM ... FK PACKAGE
(TOP VIEW)

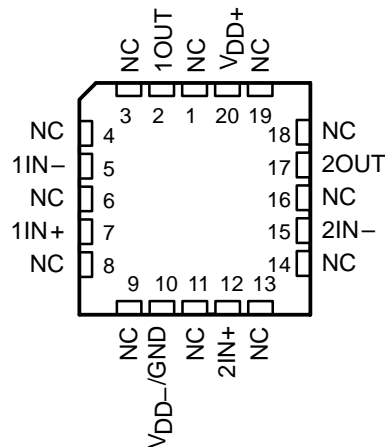

TLC2252M, TLC2252AM ... JG PACKAGE
(TOP VIEW)

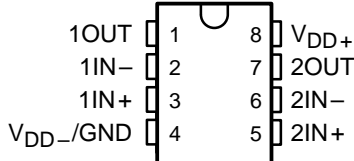

TLC2262M, TLC2252AM ... U PACKAGE
(TOP VIEW)

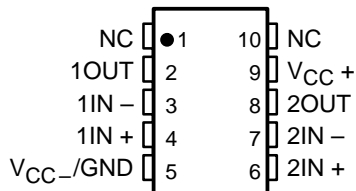

TLC2254C, TLC2254AC
TLC2254I, TLC2254AI
TLC2254Q, TLC2254AQ
D, N, OR PW PACKAGE
(TOP VIEW)

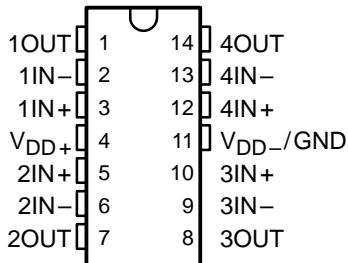

TLC2254M, TLC2254AM
J OR W PACKAGE
(TOP VIEW)

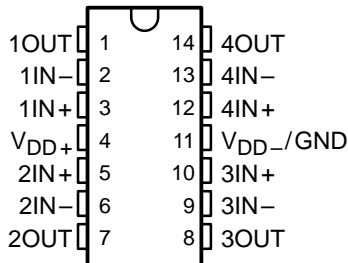

TLC2254M, TLC2254AM
FK PACKAGE
(TOP VIEW)

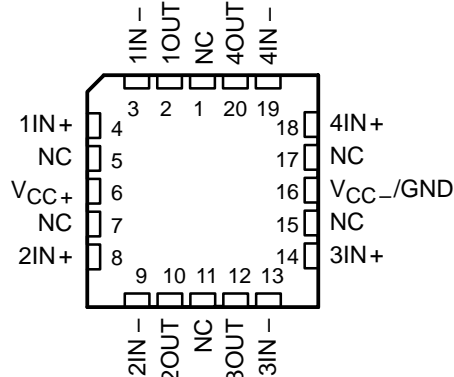

NC – No internal connection

TLC225x, TLC225xA
Advanced LinCMOS™ RAIL-TO-RAIL
VERY LOW-POWER OPERATIONAL AMPLIFIERS

SLOS176D – FEBRUARY 1997 – REVISED MARCH 2001

equivalent schematic (each amplifier)

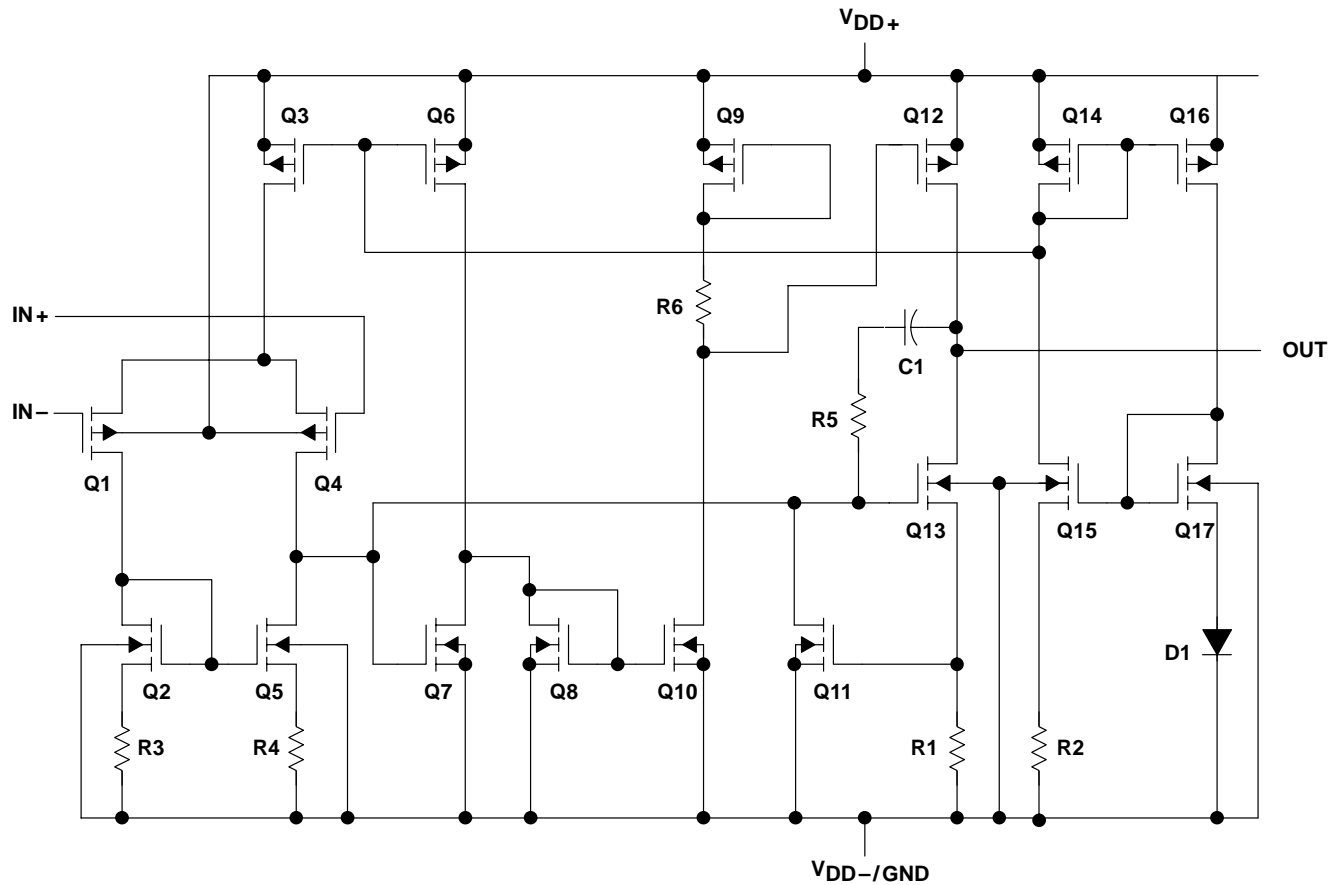

ACTUAL DEVICE COMPONENT COUNT†		
COMPONENT	TLC2252	TLC2254
Transistors	38	76
Resistors	30	56
Diodes	9	18
Capacitors	3	6

† Includes both amplifiers and all ESD, bias, and trim circuitry



absolute maximum ratings over operating free-air temperature range (unless otherwise noted)†

Supply voltage, V_{DD+} (see Note 1)	8 V
Supply voltage, V_{DD-} (see Note 1)	-8 V
Differential input voltage, V_{ID} (see Note 2)	±16 V
Input voltage, V_I (any input, see Note 1)	±8 V
Input current, I_I (each input)	±5 mA
Output current, I_O	±50 mA
Total current into V_{DD+}	±50 mA
Total current out of V_{DD-}	±50 mA
Duration of short-circuit current at (or below) 25°C (see Note 3)	unlimited
Continuous total dissipation	See Dissipation Rating Table
Operating free-air temperature range, T_A : C suffix	0°C to 70°C
I suffix	-40°C to 125°C
Q suffix	-40°C to 125°C
M suffix	-55°C to 125°C
Storage temperature range, T_{stg}	-65°C to 150°C
Lead temperature 1,6 mm (1/16 inch) from case for 10 seconds	260°C

† Stresses beyond those listed under “absolute maximum ratings” may cause permanent damage to the device. These are stress ratings only, and functional operation of the device at these or any other conditions beyond those indicated under “recommended operating conditions” is not implied. Exposure to absolute-maximum-rated conditions for extended periods may affect device reliability.

- NOTES: 1. All voltage values, except differential voltages, are with respect to the midpoint between V_{DD+} and V_{DD-} .
 2. Differential voltages are at $IN+$ with respect to $IN-$. Excessive current flows when input is brought below $V_{DD-} - 0.3$ V.
 3. The output may be shorted to either supply. Temperature and/or supply voltages must be limited to ensure that the maximum dissipation rating is not exceeded.

DISSIPATION RATING TABLE

PACKAGE	$T_A \leq 25^\circ\text{C}$ POWER RATING	DERATING FACTOR ABOVE $T_A = 25^\circ\text{C}$	$T_A = 70^\circ\text{C}$ POWER RATING	$T_A = 85^\circ\text{C}$ POWER RATING	$T_A = 125^\circ\text{C}$ POWER RATING
D-8	724 mW	5.8 mW/°C	464 mW	377 mW	144 mW
D-14	950 mW	7.6 mW/°C	608 mW	450 mW	190 mW
FK	1375 mW	11.0 mW/°C	880 mW	715 mW	275 mW
J	1375 mW	11.0 mW/°C	880 mW	715 mW	275 mW
JG	1050 mW	8.4 mW/°C	672 mW	546 mW	275 mW
N	1150 mW	9.2 mW/°C	736 mW	736 mW	—
P	1000 mW	8.0 mW/°C	640 mW	520 mW	—
PW-8	525 mW	4.2 mW/°C	336 mW	273 mW	—
PW-14	700 mW	5.6 mW/°C	448 mW	448 mW	—
U	700 mW	5.5 mW/°C	246 mW	330 mW	150 mW
W	700 mW	5.5 mW/°C	246 mW	330 mW	150 mW

recommended operating conditions

	C SUFFIX		I SUFFIX		Q SUFFIX		M SUFFIX		UNIT
	MIN	MAX	MIN	MAX	MIN	MAX	MIN	MAX	
Supply voltage, $V_{DD\pm}$	±2.2	±8	±2.2	±8	±2.2	±8	±2.2	±8	V
Input voltage range, V_I	V_{DD-}	$V_{DD+} - 1.5$	V_{DD-}	$V_{DD+} - 1.5$	V_{DD-}	$V_{DD+} - 1.5$	V_{DD-}	$V_{DD+} - 1.5$	V
Common-mode input voltage, V_{IC}	V_{DD-}	$V_{DD+} - 1.5$	V_{DD-}	$V_{DD+} - 1.5$	V_{DD-}	$V_{DD+} - 1.5$	V_{DD-}	$V_{DD+} - 1.5$	V
Operating free-air temperature, T_A	0	70	-40	125	-40	125	-55	125	°C

TLC225x, TLC225xA
Advanced LinCMOS™ RAIL-TO-RAIL
VERY LOW-POWER OPERATIONAL AMPLIFIERS

SLOS176D – FEBRUARY 1997 – REVISED MARCH 2001

electrical characteristics at specified free-air temperature, $V_{DD} = 5\text{ V}$ (unless otherwise noted)

PARAMETER	TEST CONDITIONS	T_A †	TLC2252C			UNIT
			MIN	TYP	MAX	
V_{IO} Input offset voltage	$V_{IC} = 0,$ $V_O = 0,$ $V_{DD} \pm = \pm 2.5\text{ V},$ $R_S = 50\ \Omega$	25°C	200	1500		μV
		Full range			1750	
αV_{IO} Temperature coefficient of input offset voltage		25°C to 70°C	0.5			$\mu\text{V}/^\circ\text{C}$
Input offset voltage long-term drift (see Note 4)		25°C	0.003			$\mu\text{V}/\text{mo}$
I_{IO} Input offset current		25°C	0.5	60		pA
		Full range			100	
I_{IB} Input bias current		25°C	1	60		pA
		Full range			100	
V_{ICR} Common-mode input voltage range	$R_S = 50\ \Omega,$ $ V_{IO} \leq 5\text{ mV}$	25°C	0 to 4	-0.3 to 4.2		V
		Full range	0 to 3.5			
V_{OH} High-level output voltage	$I_{OH} = -20\ \mu\text{A}$	25°C	4.98		V	
	$I_{OH} = -75\ \mu\text{A}$	25°C	4.9	4.94		
	Full range		4.8			
	$I_{OH} = -150\ \mu\text{A}$	25°C	4.8	4.88		
V_{OL} Low-level output voltage	$V_{IC} = 2.5\text{ V},$ $I_{OL} = 50\ \mu\text{A}$	25°C	0.01		V	
	$V_{IC} = 2.5\text{ V},$ $I_{OL} = 500\ \mu\text{A}$	25°C	0.09	0.15		
		Full range		0.15		
	$V_{IC} = 2.5\text{ V},$ $I_{OL} = 1\text{ mA}$	25°C	0.2	0.3		
		Full range		0.3		
	$V_{IC} = 2.5\text{ V},$ $I_{OL} = 4\text{ mA}$	25°C	0.7	1		
		Full range		1.2		
	A_{VD} Large-signal differential voltage amplification	$V_{IC} = 2.5\text{ V},$ $V_O = 1\text{ V to }4\text{ V}$	$R_L = 100\text{ k}\Omega^\ddagger$	25°C		100
$R_L = 1\text{ M}\Omega^\ddagger$			Full range	10		
			25°C		1700	
r_{id} Differential input resistance		25°C	10^{12}		Ω	
r_{ic} Common-mode input resistance		25°C	10^{12}		Ω	
c_{ic} Common-mode input capacitance	$f = 10\text{ kHz},$ P package	25°C	8		pF	
z_o Closed-loop output impedance	$f = 25\text{ kHz},$ $A_V = 10$	25°C	200		Ω	
CMRR Common-mode rejection ratio	$V_{IC} = 0\text{ to }2.7\text{ V},$ $V_O = 2.5\text{ V},$ $R_S = 50\ \Omega$	25°C	70	83	dB	
		Full range	70			
k_{SVR} Supply-voltage rejection ratio ($\Delta V_{DD}/\Delta V_{IO}$)	$V_{DD} = 4.4\text{ V to }16\text{ V},$ $V_{IC} = V_{DD}/2,$ No load	25°C	80	95	dB	
		Full range	80			
I_{DD} Supply current	$V_O = 2.5\text{ V},$ No load	25°C	70	125	μA	
		Full range		150		

† Full range is 0°C to 70°C.

‡ Referenced to 2.5 V

NOTE 4: Typical values are based on the input offset voltage shift observed through 500 hours of operating life test at $T_A = 150^\circ\text{C}$ extrapolated to $T_A = 25^\circ\text{C}$ using the Arrhenius equation and assuming an activation energy of 0.96 eV.

TLC225x, TLC225xA
Advanced LinCMOS™ RAIL-TO-RAIL
VERY LOW-POWER OPERATIONAL AMPLIFIERS

SLOS176D – FEBRUARY 1997 – REVISED MARCH 2001

operating characteristics at specified free-air temperature, $V_{DD} = 5\text{ V}$

PARAMETER		TEST CONDITIONS		T_A †	TLC2252C			UNIT
					MIN	TYP	MAX	
SR	Slew rate at unity gain	$V_O = 1.5\text{ V to }3.5\text{ V}, R_L = 100\text{ k}\Omega^\ddagger,$ $C_L = 100\text{ pF}^\ddagger$		25°C	0.07	0.12	$\text{V}/\mu\text{s}$	
				Full range	0.05			
V_n	Equivalent input noise voltage	f = 10 Hz		25°C	36		$\text{nV}/\sqrt{\text{Hz}}$	
		f = 1 kHz		25°C	19			
$V_{N(PP)}$	Peak-to-peak equivalent input noise voltage	f = 0.1 Hz to 1 Hz		25°C	0.7		μV	
		f = 0.1 Hz to 10 Hz		25°C	1.1			
I_n	Equivalent input noise current			25°C	0.6		$\text{fA}/\sqrt{\text{Hz}}$	
THD + N	Total harmonic distortion plus noise	$V_O = 0.5\text{ V to }2.5\text{ V},$ f = 10 kHz, $R_L = 50\text{ k}\Omega^\ddagger$		25°C	$A_V = 1$			
					$A_V = 10$			
Gain-bandwidth product		f = 10 kHz, $C_L = 100\text{ pF}^\ddagger$	$R_L = 50\text{ k}\Omega^\ddagger,$	25°C	0.2		MHz	
BOM	Maximum output-swing bandwidth	$V_{O(PP)} = 2\text{ V},$ $R_L = 50\text{ k}\Omega^\ddagger,$	$A_V = 1,$ $C_L = 100\text{ pF}^\ddagger$	25°C	30		kHz	
ϕ_m	Phase margin at unity gain	$R_L = 50\text{ k}\Omega^\ddagger,$	$C_L = 100\text{ pF}^\ddagger$	25°C	63°			
	Gain margin			25°C	15		dB	

† Full range is 0°C to 70°C.

‡ Referenced to 2.5 V

TLC225x, TLC225xA
Advanced LinCMOS™ RAIL-TO-RAIL
VERY LOW-POWER OPERATIONAL AMPLIFIERS

SLOS176D – FEBRUARY 1997 – REVISED MARCH 2001

electrical characteristics at specified free-air temperature, $V_{DD\pm} = \pm 5\text{ V}$ (unless otherwise specified)

PARAMETER	TEST CONDITIONS	T _A †	TLC2252C			UNIT
			MIN	TYP	MAX	
V _{IO} Input offset voltage	V _{IC} = 0, V _O = 0, R _S = 50 Ω	25°C	200	1500		μV
		Full range		1750		
αV _{IO} Temperature coefficient of input offset voltage		25°C to 70°C	0.5			μV/°C
Input offset voltage long-term drift (see Note 4)		25°C	0.003			μV/mo
I _{IO} Input offset current		25°C	0.5	60		pA
		Full range		100		
I _{IB} Input bias current		25°C	1	60		pA
		Full range		100		
V _{ICR} Common-mode input voltage range	V _{IO} ≤ 5 mV, R _S = 50 Ω	25°C	-5 to 4	-5.3 to 4.2		V
		Full range	-5 to 3.5			
V _{OM+} Maximum positive peak output voltage	I _O = -20 μA	25°C	4.98		V	
	I _O = -100 μA	25°C	4.9	4.93		
		Full range	4.7			
	I _O = -200 μA	25°C	4.8	4.86		
V _{OM-} Maximum negative peak output voltage	V _{IC} = 0, I _O = 50 μA	25°C	-4.99		V	
		25°C	-4.85	-4.91		
	V _{IC} = 0, I _O = 500 μA	Full range	-4.85			
		25°C	-4.7	-4.8		
	V _{IC} = 0, I _O = 1 mA	Full range	-4.7			
		25°C	-4	-4.3		
	V _{IC} = 0, I _O = 4 mA	Full range	-3.8			
		25°C	45	650		V/mV
A _{VD} Large-signal differential voltage amplification	V _O = ±4 V	R _L = 100 kΩ	Full range	10		
		R _L = 1 MΩ	25°C	3000		
r _{id} Differential input resistance		25°C	10 ¹²	Ω		
r _{ic} Common-mode input resistance		25°C	10 ¹²	Ω		
c _{ic} Common-mode input capacitance	f = 10 kHz, P package	25°C	8	pF		
z _o Closed-loop output impedance	f = 25 kHz, A _V = 10	25°C	190	Ω		
CMRR Common-mode rejection ratio	V _{IC} = -5 V to 2.7 V, V _O = 0, R _S = 50 Ω	25°C	75	88	dB	
		Full range	75			
k _{SVR} Supply-voltage rejection ratio (ΔV _{DD±} /ΔV _{IO})	V _{DD±} = 2.2 V to ±8 V, V _{IC} = 0, No load	25°C	80	95	dB	
		Full range	80			
I _{DD} Supply current	V _O = 0, No load	25°C	80	125	μA	
		Full range		150		

† Full range is 0°C to 70°C.

NOTE 4: Typical values are based on the input offset voltage shift observed through 500 hours of operating life test at T_A = 150°C extrapolated to T_A = 25°C using the Arrhenius equation and assuming an activation energy of 0.96 eV.

TLC225x, TLC225xA
Advanced LinCMOS™ RAIL-TO-RAIL
VERY LOW-POWER OPERATIONAL AMPLIFIERS

SLOS176D – FEBRUARY 1997 – REVISED MARCH 2001

operating characteristics at specified free-air temperature, $V_{DD\pm} = \pm 5\text{ V}$

PARAMETER		TEST CONDITIONS		T_A †	TLC2252C			UNIT
					MIN	TYP	MAX	
SR	Slew rate at unity gain	$V_O = \pm 1.9\text{ V}$, $C_L = 100\text{ pF}$	$R_L = 100\text{ k}\Omega$	25°C	0.07	0.12	V/ μ s	
				Full range	0.05			
V_n	Equivalent input noise voltage	f = 10 Hz		25°C	38		nV/ $\sqrt{\text{Hz}}$	
		f = 1 kHz		25°C	19			
$V_{N(PP)}$	Peak-to-peak equivalent input noise voltage	f = 0.1 Hz to 1 Hz		25°C	0.8		μ V	
		f = 0.1 Hz to 10 Hz		25°C	1.1			
I_n	Equivalent input noise current			25°C	0.6		fA/ $\sqrt{\text{Hz}}$	
THD + N	Total harmonic distortion pulse duration	$V_O = \pm 2.3\text{ V}$, f = 10 kHz, $R_L = 50\text{ k}\Omega$	$A_V = 1$	25°C	0.2%			
			$A_V = 10$		1%			
Gain-bandwidth product		f = 10 kHz, $C_L = 100\text{ pF}$	$R_L = 50\text{ k}\Omega$	25°C	0.21		MHz	
B_{OM}	Maximum output-swing bandwidth	$V_{O(PP)} = 4.6\text{ V}$, $R_L = 50\text{ k}\Omega$	$A_V = 1$, $C_L = 100\text{ pF}$	25°C	14		kHz	
ϕ_m	Phase margin at unity gain	$R_L = 50\text{ k}\Omega$	$C_L = 100\text{ pF}$	25°C	63°			
	Gain margin			25°C	15		dB	

† Full range is 0°C to 70°C.

TLC225x, TLC225xA
Advanced LinCMOS™ RAIL-TO-RAIL
VERY LOW-POWER OPERATIONAL AMPLIFIERS

SLOS176D – FEBRUARY 1997 – REVISED MARCH 2001

electrical characteristics at specified free-air temperature, $V_{DD} = 5\text{ V}$ (unless otherwise noted)

PARAMETER	TEST CONDITIONS	T_A †	TLC2254C			UNIT
			MIN	TYP	MAX	
V_{IO} Input offset voltage	$V_{IC} = 0,$ $V_O = 0,$ $V_{DD\pm} = \pm 2.5\text{ V},$ $R_S = 50\ \Omega$	25°C	200	1500		μV
		Full range		1750		
$\alpha_{V_{IO}}$ Temperature coefficient of input offset voltage		25°C to 70°C	0.5			$\mu\text{V}/^\circ\text{C}$
Input offset voltage long-term drift (see Note 4)		25°C	0.003			$\mu\text{V}/\text{mo}$
I_{IO} Input offset current		25°C	0.5	60		pA
		Full range		100		
I_{IB} Input bias current		25°C	1	60		pA
		Full range		100		
V_{ICR} Common-mode input voltage range	$R_S = 50\ \Omega,$ $ V_{IO} \leq 5\text{ mV}$	25°C	0 to 4	-0.3 to 4.2		V
		Full range	0 to 3.5			
V_{OH} High-level output voltage	$I_{OH} = -20\ \mu\text{A}$	25°C		4.98		V
	$I_{OH} = -75\ \mu\text{A}$	25°C	4.9	4.94		
	Full range		4.8			
	$I_{OH} = -150\ \mu\text{A}$	25°C	4.8	4.88		
V_{OL} Low-level output voltage	$V_{IC} = 2.5\text{ V}, I_{OL} = 50\ \mu\text{A}$	25°C	0.01			V
	$V_{IC} = 2.5\text{ V}, I_{OL} = 500\ \mu\text{A}$	25°C	0.09	0.15		
		Full range		0.15		
	$V_{IC} = 2.5\text{ V}, I_{OL} = 1\text{ mA}$	25°C	0.2	0.3		
		Full range		0.3		
	$V_{IC} = 2.5\text{ V}, I_{OL} = 4\text{ mA}$	25°C	0.7	1		
Full range			1.2			
A_{VD} Large-signal differential voltage amplification	$V_{IC} = 2.5\text{ V},$ $V_O = 1\text{ V to }4\text{ V}$	$R_L = 100\text{ k}\Omega$ ‡	25°C	100	350	V/mV
		$R_L = 1\text{ M}\Omega$ ‡	Full range	10		
			25°C		1700	
$r_{i(d)}$ Differential input resistance		25°C		10^{12}	Ω	
$r_{i(c)}$ Common-mode input resistance		25°C		10^{12}	Ω	
$c_{i(c)}$ Common-mode input capacitance	$f = 10\text{ kHz},$ N package	25°C		8	pF	
z_o Closed-loop output impedance	$f = 25\text{ kHz},$ $A_V = 10$	25°C		200	Ω	
CMRR Common-mode rejection ratio	$V_{IC} = 0\text{ to }2.7\text{ V},$ $V_O = 2.5\text{ V},$ $R_S = 50\ \Omega$	25°C	70	83		dB
		Full range	70			
k_{SVR} Supply-voltage rejection ratio ($\Delta V_{DD}/\Delta V_{IO}$)	$V_{DD} = 4.4\text{ V to }16\text{ V},$ $V_{IC} = V_{DD}/2,$ No load	25°C	80	95		dB
		Full range	80			
I_{DD} Supply current (four amplifiers)	$V_O = 2.5\text{ V},$ No load	25°C	140	250		μA
		Full range		300		

† Full range is 0°C to 70°C.

‡ Referenced to 2.5 V

NOTE 4: Typical values are based on the input offset voltage shift observed through 500 hours of operating life test at $T_A = 150^\circ\text{C}$ extrapolated to $T_A = 25^\circ\text{C}$ using the Arrhenius equation and assuming an activation energy of 0.96 eV.

TLC225x, TLC225xA
Advanced LinCMOS™ RAIL-TO-RAIL
VERY LOW-POWER OPERATIONAL AMPLIFIERS

SLOS176D – FEBRUARY 1997 – REVISED MARCH 2001

operating characteristics at specified free-air temperature, $V_{DD} = 5\text{ V}$

PARAMETER		TEST CONDITIONS		T_A †	TLC2254C			UNIT
					MIN	TYP	MAX	
SR	Slew rate at unity gain	$V_O = 1.4\text{ V to }2.6\text{ V}$ $R_L = 100\text{ k}\Omega$ ‡, $C_L = 100\text{ pF}$ ‡		25°C	0.07	0.12	V/ μ s	
				Full range	0.05			
V_n	Equivalent input noise voltage			25°C	36		nV/ $\sqrt{\text{Hz}}$	
				25°C	19			
$V_{N(PP)}$	Peak-to-peak equivalent input noise voltage			25°C	0.7		μ V	
				25°C	1.1			
I_n	Equivalent input noise current			25°C	0.6		fA/ $\sqrt{\text{Hz}}$	
THD + N	Total harmonic distortion plus noise	$V_O = 0.5\text{ V to }2.5\text{ V}$, $f = 10\text{ kHz}$, $R_L = 50\text{ k}\Omega$ ‡		25°C	$A_V = 1$			
					$A_V = 10$			
	Gain-bandwidth product	$f = 10\text{ kHz}$, $C_L = 100\text{ pF}$ ‡	$R_L = 50\text{ k}\Omega$ ‡,	25°C	0.2		MHz	
BOM	Maximum output-swing bandwidth	$V_{O(PP)} = 2\text{ V}$, $R_L = 50\text{ k}\Omega$ ‡,	$A_V = 1$, $C_L = 100\text{ pF}$ ‡	25°C	30		kHz	
ϕ_m	Phase margin at unity gain	$R_L = 50\text{ k}\Omega$ ‡,	$C_L = 100\text{ pF}$ ‡	25°C	63°			
	Gain margin			25°C	15		dB	

† Full range is 0°C to 70°C.

‡ Referenced to 2.5 V

TLC225x, TLC225xA
Advanced LinCMOS™ RAIL-TO-RAIL
VERY LOW-POWER OPERATIONAL AMPLIFIERS

SLOS176D – FEBRUARY 1997 – REVISED MARCH 2001

electrical characteristics at specified free-air temperature, $V_{DD\pm} = \pm 5\text{ V}$ (unless otherwise specified)

PARAMETER	TEST CONDITIONS	T _A †	TLC2254C			UNIT
			MIN	TYP	MAX	
V _{IO} Input offset voltage	V _{IC} = 0, V _O = 0, R _S = 50 Ω	25°C	200	1500	μV	
		Full range	1750			
α _{VIO} Temperature coefficient of input offset voltage		25°C to 70°C	0.5		μV/°C	
Input offset voltage long-term drift (see Note 4)		25°C	0.003		μV/mo	
I _{IO} Input offset current		25°C	0.5	60	pA	
		Full range	100			
I _{IB} Input bias current		25°C	1	60	pA	
		Full range	100			
V _{ICR} Common-mode input voltage range	V _{IO} ≤ 5 mV, R _S = 50 Ω	25°C	-5 to 4	-5.3 to 4.2	V	
		Full range	-5 to 3.5			
V _{OM+} Maximum positive peak output voltage	I _O = -20 μA	25°C	4.98		V	
	I _O = -100 μA	25°C	4.9	4.93		
		Full range	4.7			
	I _O = -200 μA	25°C	4.8	4.86		
V _{OM-} Maximum negative peak output voltage	V _{IC} = 0, I _O = 50 μA	25°C	-4.99		V	
		Full range	-4.85			
	V _{IC} = 0, I _O = 500 μA	25°C	-4.85	-4.91		
		Full range	-4.85			
	V _{IC} = 0, I _O = 1 mA	25°C	-4.7	-4.8		
		Full range	-4.7			
	V _{IC} = 0, I _O = 4 mA	25°C	-4	-4.3		
		Full range	-3.8			
A _{VD} Large-signal differential voltage amplification	V _O = ±4 V	R _L = 100 kΩ	25°C	40	150	V/mV
			Full range	10		
		R _L = 1 MΩ	25°C	3000		
r _{i(d)} Differential input resistance		25°C	10 ¹²		Ω	
r _{i(c)} Common-mode input resistance		25°C	10 ¹²		Ω	
c _{i(c)} Common-mode input capacitance	f = 10 kHz, N package	25°C	8		pF	
z _O Closed-loop output impedance	f = 25 kHz, A _V = 10	25°C	190		Ω	
CMRR Common-mode rejection ratio	V _{IC} = -5 V to 2.7 V, V _O = 0, R _S = 50 Ω	25°C	75	88	dB	
		Full range	75			
k _{SVR} Supply-voltage rejection ratio (ΔV _{DD±} /ΔV _{IO})	V _{DD±} = ±2.2 V to ±8 V, V _{IC} = 0, No load	25°C	80	95	dB	
		Full range	80			
I _{DD} Supply current (four amplifiers)	V _O = 0, No load	25°C	160	250	μA	
		Full range	300			

† Full range is 0°C to 70°C.

NOTE 4: Typical values are based on the input offset voltage shift observed through 500 hours of operating life test at T_A = 150°C extrapolated to T_A = 25°C using the Arrhenius equation and assuming an activation energy of 0.96 eV.

TLC225x, TLC225xA
Advanced LinCMOS™ RAIL-TO-RAIL
VERY LOW-POWER OPERATIONAL AMPLIFIERS

SLOS176D – FEBRUARY 1997 – REVISED MARCH 2001

operating characteristics at specified free-air temperature, $V_{DD\pm} = \pm 5\text{ V}$

PARAMETER		TEST CONDITIONS		T_A †	TLC2254C			UNIT
					MIN	TYP	MAX	
SR	Slew rate at unity gain	$V_O = \pm 1.9\text{ V}$, $C_L = 100\text{ pF}$	$R_L = 100\text{ k}\Omega$	25°C	0.07	0.12	$\text{V}/\mu\text{s}$	
				Full range	0.05			
V_n	Equivalent input noise voltage			25°C	38		$\text{nV}/\sqrt{\text{Hz}}$	
				25°C	19			
$V_{N(PP)}$	Peak-to-peak equivalent input noise voltage			25°C	0.8		μV	
				25°C	1.1			
I_n	Equivalent input noise current			25°C	0.6		$\text{fA}/\sqrt{\text{Hz}}$	
THD + N	Total harmonic distortion plus noise	$V_O = \pm 2.3\text{ V}$, $f = 20\text{ kHz}$, $R_L = 50\text{ k}\Omega$		25°C	$A_V = 1$			
					$A_V = 10$			
	Gain-bandwidth product	$f = 10\text{ kHz}$, $C_L = 100\text{ pF}$	$R_L = 50\text{ k}\Omega$	25°C	0.21		MHz	
B_{OM}	Maximum output-swing bandwidth	$V_{O(PP)} = 4.6\text{ V}$, $R_L = 50\text{ k}\Omega$	$A_V = 1$, $C_L = 100\text{ pF}$	25°C	14		kHz	
ϕ_m	Phase margin at unity gain	$R_L = 50\text{ k}\Omega$	$C_L = 100\text{ pF}$	25°C	63°			
	Gain margin			25°C	15		dB	

† Full range is 0°C to 70°C.

TLC225x, TLC225xA
Advanced LinCMOS™ RAIL-TO-RAIL
VERY LOW-POWER OPERATIONAL AMPLIFIERS

SLOS176D – FEBRUARY 1997 – REVISED MARCH 2001

electrical characteristics at specified free-air temperature, $V_{DD} = 5\text{ V}$ (unless otherwise noted)

PARAMETER	TEST CONDITIONS	T_A †	TLC2252I			TLC2252AI			UNIT
			MIN	TYP	MAX	MIN	TYP	MAX	
V_{IO} Input offset voltage	$V_{DD\pm} = \pm 2.5\text{ V}$, $V_O = 0$, $V_{IC} = 0$, $R_S = 50\ \Omega$	25°C	200	1500		200	850	μV	
		Full range		1750		1000			
α_{VIO} Temperature coefficient of input offset voltage		25°C to 85°C	0.5			0.5			$\mu\text{V}/^\circ\text{C}$
Input offset voltage long-term drift (see Note 4)		25°C	0.003			0.003			$\mu\text{V}/\text{mo}$
I_{IO} Input offset current		25°C	0.5	60		0.5	60	pA	
		Full range		1000		1000			
I_{IB} Input bias current	25°C	1	60		1	60	pA		
	Full range		1000		1000				
V_{ICR} Common-mode input voltage range	$R_S = 50\ \Omega$, $ V_{IO} \leq 5\text{ mV}$	25°C	0 to 4	-0.3 to 4.2		0 to 4	-0.3 to 4.2	V	
		Full range	0 to 3.5		0 to 3.5				
V_{OH} High-level output voltage	$I_{OH} = -20\ \mu\text{A}$	25°C	4.98			4.98			V
	$I_{OH} = -75\ \mu\text{A}$	25°C	4.9	4.94		4.9	4.94		
	Full range	4.8			4.8				
V_{OL} Low-level output voltage	$V_{IC} = 2.5\text{ V}$, $I_{OL} = 50\ \mu\text{A}$	25°C	0.01			0.01			V
	$V_{IC} = 2.5\text{ V}$, $I_{OL} = 500\ \mu\text{A}$	25°C	0.09	0.15		0.09	0.15		
		Full range		0.15		0.15			
	$V_{IC} = 2.5\text{ V}$, $I_{OL} = 4\text{ mA}$	25°C	0.8	1		0.7	1		
Full range			1.2		1.2				
A_{VD} Large-signal differential voltage amplification	$V_{IC} = 2.5\text{ V}$, $V_O = 1\text{ V to }4\text{ V}$	$R_L = 100\text{ k}\Omega$ ‡	25°C	100	350		100	350	V/mV
			Full range	10			10		
		$R_L = 1\text{ M}\Omega$ ‡	25°C	1700			1700		
r_{id} Differential input resistance		25°C	10^{12}			10^{12}			Ω
r_{ic} Common-mode input resistance		25°C	10^{12}			10^{12}			Ω
C_{ic} Common-mode input capacitance	$f = 10\text{ kHz}$, P package	25°C	8			8			pF
z_o Closed-loop output impedance	$f = 25\text{ kHz}$, $A_V = 10$	25°C	200			200			Ω
CMRR Common-mode rejection ratio	$V_{IC} = 0\text{ to }2.7\text{ V}$, $V_O = 2.5\text{ V}$, $R_S = 50\ \Omega$	25°C	70	83		70	83	dB	
		Full range	70			70			
kSVR Supply-voltage rejection ratio ($\Delta V_{DD}/\Delta V_{IO}$)	$V_{DD} = 4.4\text{ V to }16\text{ V}$, $V_{IC} = V_{DD}/2$, No load	25°C	80	95		80	95	dB	
		Full range	80			80			
I_{DD} Supply current	$V_O = 2.5\text{ V}$, No load	25°C	70	125		70	125	μA	
		Full range		150		150			

† Full range is -40°C to 125°C .

‡ Referenced to 2.5 V

NOTE 4: Typical values are based on the input offset voltage shift observed through 500 hours of operating life test at $T_A = 150^\circ\text{C}$ extrapolated to $T_A = 25^\circ\text{C}$ using the Arrhenius equation and assuming an activation energy of 0.96 eV.

TLC225x, TLC225xA
Advanced LinCMOS™ RAIL-TO-RAIL
VERY LOW-POWER OPERATIONAL AMPLIFIERS

SLOS176D – FEBRUARY 1997 – REVISED MARCH 2001

operating characteristics at specified free-air temperature, $V_{DD} = 5\text{ V}$

PARAMETER	TEST CONDITIONS	T_A †	TLC2252I			TLC2252AI			UNIT		
			MIN	TYP	MAX	MIN	TYP	MAX			
SR	Slew rate at unity gain $V_O = 1.5\text{ V to }3.5\text{ V}$, $R_L = 100\text{ k}\Omega$ ‡, $C_L = 100\text{ pF}$ ‡	25°C	0.07	0.12		0.07	0.12		V/ μs		
		Full range	0.05			0.05					
V_n	Equivalent input noise voltage	f = 10 Hz	36			36			nV/ $\sqrt{\text{Hz}}$		
		f = 1 kHz	19			19					
$V_{N(PP)}$	Peak-to-peak equivalent input noise voltage	f = 0.1 Hz to 1 Hz	0.7			0.7			μV		
		f = 0.1 Hz to 10 Hz	1.1			1.1					
I_n	Equivalent input noise current	25°C	0.6			0.6			fA/ $\sqrt{\text{Hz}}$		
THD + N	Total harmonic distortion plus noise $V_O = 0.5\text{ V to }2.5\text{ V}$, f = 10 kHz, $R_L = 50\text{ k}\Omega$ ‡	$A_V = 1$	0.2%			0.2%					
		$A_V = 10$	1%			1%					
	Gain-bandwidth product	f = 50 kHz, $C_L = 100\text{ pF}$ ‡	$R_L = 50\text{ k}\Omega$ ‡,	25°C	0.2			0.2			MHz
BOM	Maximum output-swing bandwidth	$V_{O(PP)} = 2\text{ V}$, $R_L = 50\text{ k}\Omega$ ‡,	$A_V = 1$, $R_L = 50\text{ k}\Omega$ ‡,	25°C	30			30			kHz
ϕ_m	Phase margin at unity gain	$R_L = 50\text{ k}\Omega$ ‡,	$C_L = 100\text{ pF}$ ‡	25°C	63°			63°			
				25°C	15			15			dB

† Full range is –40°C to 125°C.

‡ Referenced to 2.5 V

TLC225x, TLC225xA
Advanced LinCMOS™ RAIL-TO-RAIL
VERY LOW-POWER OPERATIONAL AMPLIFIERS

SLOS176D – FEBRUARY 1997 – REVISED MARCH 2001

electrical characteristics at specified free-air temperature, $V_{DD\pm} = \pm 5$ V (unless otherwise noted)

PARAMETER	TEST CONDITIONS	T_A †	TLC2252I			TLC2252AI			UNIT
			MIN	TYP	MAX	MIN	TYP	MAX	
V_{IO} Input offset voltage	$V_{IC} = 0, V_O = 0, R_S = 50 \Omega$	25°C	200	1500		200	850	μV	
		Full range			1750		1000		
α_{VIO} Temperature coefficient of input offset voltage		25°C to 85°C	0.5			0.5		$\mu V/^\circ C$	
Input offset voltage long-term drift (see Note 4)		25°C	0.003			0.003		$\mu V/mo$	
I_{IO} Input offset current		25°C	0.5	60		0.5	60	pA	
		Full range			1000		1000		
I_{IB} Input bias current	25°C	1	60		1	60	pA		
	Full range			1000		1000			
V_{ICR} Common-mode input voltage range	$R_S = 50 \Omega, V_{IO} \leq 5 mV$	25°C	-5 to 4	-5.3 to 4.2		-5 to 4	-5.3 to 4.2	V	
		Full range	-5 to 3.5			-5 to 3.5			
V_{OM+} Maximum positive peak output voltage	$I_O = -20 \mu A$	25°C		4.98			4.98	V	
	$I_O = -100 \mu A$	25°C	4.9	4.93		4.9	4.93		
		Full range		4.7			4.7		
	$I_O = -200 \mu A$	25°C	4.8	4.86		4.8	4.86		
V_{OM-} Maximum negative peak output voltage	$V_{IC} = 0, I_O = 50 \mu A$	25°C		-4.99			-4.99	V	
	$V_{IC} = 0, I_O = 500 \mu A$	25°C	-4.85	-4.91		-4.85	-4.91		
		Full range		-4.85			-4.85		
	$V_{IC} = 0, I_O = 4 mA$	25°C	-4	-4.3		-4	-4.3		
AVD Large-signal differential voltage amplification	$V_O = \pm 4 V$	$R_L = 50 k\Omega$	25°C	40	150		40	150	V/mV
			Full range		10			10	
			$R_L = 1 M\Omega$	25°C		3000			
r_{id} Differential input resistance		25°C		1012			1012	Ω	
r_{ic} Common-mode input resistance		25°C		1012			1012	Ω	
C_{ic} Common-mode input capacitance	$f = 10 kHz, P$ package	25°C		8			8	pF	
Z_o Closed-loop output impedance	$f = 25 kHz, A_V = 10$	25°C		190			190	Ω	
CMRR Common-mode rejection ratio	$V_{IC} = -5 V$ to 2.7 V, $V_O = 0, R_S = 50 \Omega$	25°C	75	88		75	88	dB	
		Full range		75			75		
k_{SVR} Supply-voltage rejection ratio ($\Delta V_{DD\pm} / \Delta V_{IO}$)	$V_{DD} = 4.4 V$ to 16 V, $V_{IC} = V_{DD}/2$, No load	25°C	80	95		80	95	dB	
		Full range		80			80		
I_{DD} Supply current	$V_O = 2.5 V$, No load	25°C	80	125		80	125	μA	
		Full range			150				150

† Full range is -40°C to 125°C.

NOTE 4: Typical values are based on the input offset voltage shift observed through 500 hours of operating life test at $T_A = 150^\circ C$ extrapolated to $T_A = 25^\circ C$ using the Arrhenius equation and assuming an activation energy of 0.96 eV.

TLC225x, TLC225xA
Advanced LinCMOS™ RAIL-TO-RAIL
VERY LOW-POWER OPERATIONAL AMPLIFIERS

SLOS176D – FEBRUARY 1997 – REVISED MARCH 2001

operating characteristics at specified free-air temperature, $V_{DD\pm} = \pm 5\text{ V}$

PARAMETER	TEST CONDITIONS	T_A †	TLC2252I			TLC2252AI			UNIT	
			MIN	TYP	MAX	MIN	TYP	MAX		
SR	Slew rate at unity gain $V_O = \pm 1.9\text{ V}$, $R_L = 100\text{ k}\Omega$, $C_L = 100\text{ pF}$	25°C	0.07	0.12		0.07	0.12		V/ μs	
		Full range	0.05			0.05				
V_n	Equivalent input noise voltage	f = 10 Hz	25°C			38			nV/ $\sqrt{\text{Hz}}$	
		f = 1 kHz	25°C			19				
$V_{N(PP)}$	Peak-to-peak equivalent input noise voltage	f = 0.1 Hz to 1 Hz	25°C			0.8			μV	
		f = 0.1 Hz to 10 Hz	25°C			1.1				
I_n	Equivalent input noise current	25°C	0.6			0.6			fA/ $\sqrt{\text{Hz}}$	
THD + N	Total harmonic distortion plus noise	$V_O = \pm 2.3\text{ V}$, $R_L = 50\text{ k}\Omega$, f = 10 kHz	$A_V = 1$	25°C			0.2%			
			$A_V = 10$	25°C			1%			
	Gain-bandwidth product	f = 10 kHz, $C_L = 100\text{ pF}$, $R_L = 50\text{ k}\Omega$	25°C			0.21			MHz	
BOM	Maximum output-swing bandwidth	$V_{O(PP)} = 4.6\text{ V}$, $A_V = 1$, $R_L = 50\text{ k}\Omega$, $C_L = 100\text{ pF}$	25°C			14			kHz	
ϕ_m	Phase margin at unity gain	$R_L = 50\text{ k}\Omega$, $C_L = 100\text{ pF}$	25°C			63°				
	Gain margin		25°C			15			dB	

† Full range is -40°C to 125°C .

TLC225x, TLC225xA
Advanced LinCMOS™ RAIL-TO-RAIL
VERY LOW-POWER OPERATIONAL AMPLIFIERS

SLOS176D – FEBRUARY 1997 – REVISED MARCH 2001

electrical characteristics at specified free-air temperature, $V_{DD} = 5\text{ V}$ (unless otherwise noted)

PARAMETER	TEST CONDITIONS	T_A †	TLC2254I			TLC2254AI			UNIT
			MIN	TYP	MAX	MIN	TYP	MAX	
V_{IO} Input offset voltage		25°C	200	1500		200	850	μV	
		Full range			1750		1000		
α_{VIO} Temperature coefficient of input offset voltage	$V_{DD} \pm = \pm 2.5\text{ V}$, $V_{IC} = 0$, $V_O = 0$, $R_S = 50\ \Omega$	25°C to 125°C	0.5			0.5			$\mu\text{V}/^\circ\text{C}$
Input offset voltage long-term drift (see Note 4)		25°C	0.003			0.003			$\mu\text{V}/\text{mo}$
I_{IO} Input offset current		25°C	0.5	60		0.5	60	pA	
	Full range			1000		1000			
I_{IB} Input bias current	25°C	1	60		1	60	pA		
	Full range			1000		1000			
V_{ICR} Common-mode input voltage range	$R_S = 50\ \Omega$, $ V_{IO} \leq 5\text{ mV}$	25°C	0 to 4	-0.3 to 4.2		0 to 4	-0.3 to 4.2	V	
		Full range	0 to 3.5		0 to 3.5				
V_{OH} High-level output voltage	$I_{OH} = -20\ \mu\text{A}$	25°C	4.98			4.98			V
		25°C	4.9	4.94		4.9	4.94		
		Full range	4.8			4.8			
V_{OL} Low-level output voltage	$V_{IC} = 2.5\text{ V}$, $I_{OL} = 50\ \mu\text{A}$	25°C	0.01			0.01			V
		25°C	0.09	0.15		0.09	0.15		
	Full range	0.15			0.15				
		$V_{IC} = 2.5\text{ V}$, $I_{OL} = 500\ \mu\text{A}$	25°C	0.8	1		0.7	1	
Full range	1.2			1.2					
A_{VD} Large-signal differential voltage amplification	$V_{IC} = 2.5\text{ V}$, $V_O = 1\text{ V to }4\text{ V}$	$R_L = 100\ \text{k}\Omega \ddagger$	25°C	100	350		100	350	V/mV
			Full range	10			10		
		$R_L = 1\ \text{M}\Omega \ddagger$	25°C	1700			1700		
$r_{i(d)}$ Differential input resistance		25°C	10^{12}			10^{12}			Ω
$r_{i(c)}$ Common-mode input resistance		25°C	10^{12}			10^{12}			Ω
$C_{i(c)}$ Common-mode input capacitance	$f = 10\ \text{kHz}$, N package	25°C	8			8			pF
Z_o Closed-loop output impedance	$f = 25\ \text{kHz}$, $A_V = 10$	25°C	200			200			Ω
CMRR Common-mode rejection ratio	$V_{IC} = 0\text{ to }2.7\text{ V}$, $V_O = 2.5\text{ V}$, $R_S = 50\ \Omega$	25°C	70	83		70	83	dB	
		Full range	70			70			
k_{SVR} Supply-voltage rejection ratio ($\Delta V_{DD}/\Delta V_{IO}$)	$V_{DD} = 4.4\text{ V to }16\text{ V}$, $V_{IC} = V_{DD}/2$, No load	25°C	80	95		80	95	dB	
		Full range	80			80			
I_{DD} Supply current (four amplifiers)	$V_O = 2.5\text{ V}$, No load	25°C	140	250		140	250	μA	
		Full range	300			300			

† Full range is -40°C to 125°C .

‡ Referenced to 2.5 V

NOTE 4: Typical values are based on the input offset voltage shift observed through 500 hours of operating life test at $T_A = 150^\circ\text{C}$ extrapolated to $T_A = 25^\circ\text{C}$ using the Arrhenius equation and assuming an activation energy of 0.96 eV.

TLC225x, TLC225xA
Advanced LinCMOS™ RAIL-TO-RAIL
VERY LOW-POWER OPERATIONAL AMPLIFIERS

SLOS176D – FEBRUARY 1997 – REVISED MARCH 2001

operating characteristics at specified free-air temperature, $V_{DD} = 5\text{ V}$

PARAMETER	TEST CONDITIONS	T_A †	TLC2254I			TLC2254AI			UNIT
			MIN	TYP	MAX	MIN	TYP	MAX	
SR	Slew rate at unity gain $V_O = 1.4\text{ V to }2.6\text{ V}$, $R_L = 100\text{ k}\Omega$ ‡, $C_L = 100\text{ pF}$ ‡	25°C	0.07	0.12		0.07	0.12		V/ μs
		Full range	0.05			0.05			
V_n	Equivalent input noise voltage $f = 10\text{ Hz}$ $f = 1\text{ kHz}$	25°C	36			36			nV/ $\sqrt{\text{Hz}}$
		25°C	19			19			
$V_{N(PP)}$	Peak-to-peak equivalent input noise voltage $f = 0.1\text{ Hz to }1\text{ Hz}$ $f = 0.1\text{ Hz to }10\text{ Hz}$	25°C	0.7			0.7			μV
		25°C	1.1			1.1			
I_n	Equivalent input noise current	25°C	0.6			0.6			fA/ $\sqrt{\text{Hz}}$
THD + N	Total harmonic distortion plus noise $V_O = 0.5\text{ V to }2.5\text{ V}$, $f = 20\text{ kHz}$, $R_L = 50\text{ k}\Omega$ ‡	25°C	$A_V = 1$			0.2%			
			$A_V = 10$			1%			
	Gain-bandwidth product $f = 50\text{ kHz}$, $C_L = 100\text{ pF}$ ‡	25°C	$R_L = 50\text{ k}\Omega$ ‡			0.2			MHz
BOM	Maximum output-swing bandwidth $V_{O(PP)} = 2\text{ V}$, $R_L = 50\text{ k}\Omega$ ‡	25°C	$A_V = 1$, $C_L = 100\text{ pF}$ ‡			30			kHz
ϕ_m	Phase margin at unity gain $R_L = 50\text{ k}\Omega$ ‡	25°C	$C_L = 100\text{ pF}$ ‡			63°			
	Gain margin	25°C				15			dB

† Full range is -40°C to 125°C .

‡ Referenced to 2.5 V

TLC225x, TLC225xA
Advanced LinCMOS™ RAIL-TO-RAIL
VERY LOW-POWER OPERATIONAL AMPLIFIERS

SLOS176D – FEBRUARY 1997 – REVISED MARCH 2001

electrical characteristics at specified free-air temperature, $V_{DD\pm} = \pm 5$ V (unless otherwise noted)

PARAMETER	TEST CONDITIONS	T_A †	TLC2254I			TLC2254AI			UNIT
			MIN	TYP	MAX	MIN	TYP	MAX	
V_{IO} Input offset voltage	$V_{IC} = 0, V_O = 0, R_S = 50 \Omega$	25°C	200	1500		200	850	μV	
		Full range			1750		1000		
α_{VIO} Temperature coefficient of input offset voltage		25°C to 125°C	0.5			0.5		$\mu V/^\circ C$	
Input offset voltage long-term drift (see Note 4)		25°C	0.003			0.003		$\mu V/mo$	
I_{IO} Input offset current		25°C	0.5	60		0.5	60	pA	
		Full range			1000		1000		
I_{IB} Input bias current	25°C	1	60		1	60	pA		
	Full range			1000		1000			
V_{ICR} Common-mode input voltage range	$R_S = 50 \Omega, V_{IO} \leq 5$ mV	25°C	-5 to 4	-5.3 to 4.2		-5 to 4	-5.3 to 4.2	V	
		Full range	-5 to 3.5			-5 to 3.5			
V_{OM+} Maximum positive peak output voltage	$I_O = -20 \mu A$	25°C		4.98			4.98	V	
	$I_O = -100 \mu A$	25°C	4.9	4.93		4.9	4.93		
		Full range		4.7			4.7		
	$I_O = -200 \mu A$	25°C	4.8	4.86		4.8	4.86		
V_{OM-} Maximum negative peak output voltage	$V_{IC} = 0, I_O = 50 \mu A$	25°C		-4.99			-4.99	V	
	$V_{IC} = 0, I_O = 500 \mu A$	25°C	-4.85	-4.91		-4.85	-4.91		
		Full range		-4.85			-4.85		
	$V_{IC} = 0, I_O = 4$ mA	25°C	-4	-4.3		-4	-4.3		
A_{VD} Large-signal differential voltage amplification	$V_O = \pm 4$ V	$R_L = 100$ k Ω	25°C	40	150		40	150	V/mV
			Full range		10			10	
		$R_L = 1$ M Ω	25°C		3000			3000	
$r_{i(d)}$ Differential input resistance		25°C		10^{12}			10^{12}	Ω	
$r_{i(c)}$ Common-mode input resistance		25°C		10^{12}			10^{12}	Ω	
$C_{i(c)}$ Common-mode input capacitance	$f = 10$ kHz, N package	25°C		8			8	pF	
z_o Closed-loop output impedance	$f = 25$ kHz, $A_V = 10$	25°C		190			190	Ω	
CMRR Common-mode rejection ratio	$V_{IC} = -5$ V to 2.7 V, $V_O = 0, R_S = 50 \Omega$	25°C	75	88		75	88	dB	
		Full range		75			75		
k_{SVR} Supply-voltage rejection ratio ($\Delta V_{DD\pm}/\Delta V_{IO}$)	$V_{DD\pm} = \pm 2.2$ V to ± 8 V, $V_{IC} = V_{DD}/2$, No load	25°C	80	95		80	95	dB	
		Full range		80			80		
I_{DD} Supply current (four amplifiers)	$V_O = 0$, No load	25°C	160	250		160	250	μA	
		Full range			300		300		

† Full range is -40°C to 125°C.

NOTE 4: Typical values are based on the input offset voltage shift observed through 500 hours of operating life test at $T_A = 150^\circ C$ extrapolated to $T_A = 25^\circ C$ using the Arrhenius equation and assuming an activation energy of 0.96 eV.

TLC225x, TLC225xA
Advanced LinCMOS™ RAIL-TO-RAIL
VERY LOW-POWER OPERATIONAL AMPLIFIERS

SLOS176D – FEBRUARY 1997 – REVISED MARCH 2001

operating characteristics at specified free-air temperature, $V_{DD\pm} = \pm 5\text{ V}$

PARAMETER	TEST CONDITIONS	T_A †	TLC2254I			TLC2254AI			UNIT
			MIN	TYP	MAX	MIN	TYP	MAX	
SR	Slew rate at unity gain $V_O = \pm 1.9\text{ V}$, $C_L = 100\text{ pF}$, $R_L = 100\text{ k}\Omega$	25°C	0.07	0.12		0.07	0.12		V/ μs
		Full range	0.05			0.05			
V_n	Equivalent input noise voltage	25°C	38			38			nV/ $\sqrt{\text{Hz}}$
		25°C	19			19			
$V_{N(PP)}$	Peak-to-peak equivalent input noise voltage	25°C	0.8			0.8			μV
		25°C	1.1			1.1			
I_n	Equivalent input noise current	25°C	0.6			0.6			fA/ $\sqrt{\text{Hz}}$
THD + N	Total harmonic distortion plus noise $V_O = \pm 2.3\text{ V}$, $R_L = 50\text{ k}\Omega$, $f = 20\text{ kHz}$	25°C	0.2%			0.2%			
			1%			1%			
	Gain-bandwidth product $f = 10\text{ kHz}$, $C_L = 100\text{ pF}$, $R_L = 50\text{ k}\Omega$	25°C	0.21			0.21			MHz
BOM	Maximum output-swing bandwidth $V_{O(PP)} = 4.6\text{ V}$, $R_L = 50\text{ k}\Omega$, $A_V = 1$, $C_L = 100\text{ pF}$	25°C	14			14			kHz
ϕ_m	Phase margin at unity gain $R_L = 50\text{ k}\Omega$, $C_L = 100\text{ pF}$	25°C	63°			63°			
		25°C	15			15			

† Full range is -40°C to 125°C .

TLC225x, TLC225xA
Advanced LinCMOS™ RAIL-TO-RAIL
VERY LOW-POWER OPERATIONAL AMPLIFIERS

SLOS176D – FEBRUARY 1997 – REVISED MARCH 2001

electrical characteristics at specified free-air temperature, $V_{DD} = 5\text{ V}$ (unless otherwise noted)

PARAMETER	TEST CONDITIONS	T_A †	TLC2252Q TLC2252M			TLC2252AQ TLC2252AM			UNIT
			MIN	TYP	MAX	MIN	TYP	MAX	
V_{IO} Input offset voltage	$V_{DD\pm} = \pm 2.5\text{ V}$, $V_O = 0$, $V_{IC} = 0$, $R_S = 50\ \Omega$	25°C	200	1500		200	850	μV	
		Full range		1750		1000			
α_{VIO} Temperature coefficient of input offset voltage		25°C to 125°C	0.5			0.5		$\mu\text{V}/^\circ\text{C}$	
Input offset voltage long-term drift (see Note 4)		25°C	0.003			0.003		$\mu\text{V}/\text{mo}$	
I_{IO} Input offset current		25°C	0.5	60		0.5	60	pA	
		Full range		1000		1000			
I_{IB} Input bias current	25°C	1	60		1	60	pA		
	Full range		1000		1000				
V_{ICR} Common-mode input voltage range	$R_S = 50\ \Omega$, $ V_{IO} \leq 5\text{ mV}$	25°C	0 to 4	-0.3 to 4.2		0 to 4	-0.3 to 4.2	V	
		Full range	0 to 3.5			0 to 3.5			
V_{OH} High-level output voltage	$I_{OH} = -20\ \mu\text{A}$ $I_{OH} = -75\ \mu\text{A}$ $I_{OH} = -150\ \mu\text{A}$	25°C	4.98			4.98		V	
		25°C	4.9	4.94		4.9	4.94		
		Full range	4.8			4.8			
		25°C	4.8	4.88		4.8	4.88		
V_{OL} Low-level output voltage	$V_{IC} = 2.5\text{ V}$, $I_{OL} = 50\ \mu\text{A}$ $I_{OL} = 500\ \mu\text{A}$ $I_{OL} = 4\text{ mA}$	25°C	0.01			0.01		V	
		25°C	0.09	0.15		0.09	0.15		
		Full range		0.15			0.15		
		25°C	0.8	1		0.7	1		
		Full range		1.2			1.2		
		25°C	100	350		100	350		
AVD Large-signal differential voltage amplification	$V_{IC} = 2.5\text{ V}$, $V_O = 1\text{ V to }4\text{ V}$	$R_L = 100\text{ k}\Omega$ ‡	25°C	10			10	V/mV	
			Full range	10			10		
		$R_L = 1\text{ M}\Omega$ ‡	25°C	1700			1700		
r_{id} Differential input resistance		25°C	10 ¹²			10 ¹²	Ω		
r_{ic} Common-mode input resistance		25°C	10 ¹²			10 ¹²	Ω		
c_{ic} Common-mode input capacitance	$f = 10\text{ kHz}$, $f = 10\text{ kHz}$	25°C	8			8	pF		
z_o Closed-loop output impedance	$f = 25\text{ kHz}$, $A_V = 10$	25°C	200			200	Ω		
CMRR Common-mode rejection ratio	$V_{IC} = 0\text{ to }2.7\text{ V}$, $R_S = 50\ \Omega$, $V_O = 2.5\text{ V}$	25°C	70	83		70	83	dB	
		Full range	70			70			
k_{SVR} Supply-voltage rejection ratio ($\Delta V_{DD}/\Delta V_{IO}$)	$V_{DD} = 4.4\text{ V to }16\text{ V}$, $V_{IC} = V_{DD}/2$, No load	25°C	80	95		80	95	dB	
		Full range	80			80			
I_{DD} Supply current	$V_O = 2.5\text{ V}$, No load	25°C	70	125		70	125	μA	
		Full range		150			150		

† Full range is -40°C to 125°C for Q suffix, -55°C to 125°C for M suffix.

‡ Referenced to 2.5 V

NOTE 4: Typical values are based on the input offset voltage shift observed through 500 hours of operating life test at $T_A = 150^\circ\text{C}$ extrapolated to $T_A = 25^\circ\text{C}$ using the Arrhenius equation and assuming an activation energy of 0.96 eV.

TLC225x, TLC225xA
Advanced LinCMOS™ RAIL-TO-RAIL
VERY LOW-POWER OPERATIONAL AMPLIFIERS

SLOS176D – FEBRUARY 1997 – REVISED MARCH 2001

operating characteristics at specified free-air temperature, $V_{DD} = 5\text{ V}$

PARAMETER	TEST CONDITIONS	T_A †	TLC2252Q TLC2252M			TLC2252AQ TLC2252AM			UNIT
			MIN	TYP	MAX	MIN	TYP	MAX	
SR	Slew rate at unity gain $V_O = 0.5\text{ V to }3.5\text{ V}$, $R_L = 100\text{ k}\Omega$ ‡, $C_L = 100\text{ pF}$ ‡	25°C	0.07	0.12		0.07	0.12		$\text{V}/\mu\text{s}$
		Full range	0.05			0.05			
V_n	Equivalent input noise voltage $f = 10\text{ Hz}$ $f = 1\text{ kHz}$	25°C	36			36			$\text{nV}/\sqrt{\text{Hz}}$
		25°C	19			19			
$V_{N(PP)}$	Peak-to-peak equivalent input noise voltage $f = 0.1\text{ Hz to }1\text{ Hz}$ $f = 0.1\text{ Hz to }10\text{ Hz}$	25°C	0.7			0.7			μV
		25°C	1.1			1.1			
I_n	Equivalent input noise current	25°C	0.6			0.6			$\text{fA}/\sqrt{\text{Hz}}$
THD + N	Total harmonic distortion plus noise $V_O = 0.5\text{ V to }2.5\text{ V}$, $f = 10\text{ kHz}$, $R_L = 50\text{ k}\Omega$ ‡	25°C	$A_V = 1$			0.2%			
			$A_V = 10$			1%			
	Gain-bandwidth product $f = 50\text{ kHz}$, $C_L = 100\text{ pF}$ ‡	25°C	$R_L = 50\text{ k}\Omega$ ‡			0.2			MHz
B_{OM}	Maximum output-swing bandwidth $V_{O(PP)} = 2\text{ V}$, $R_L = 50\text{ k}\Omega$ ‡	25°C	$A_V = 1$, $C_L = 100\text{ pF}$ ‡			30			kHz
ϕ_m	Phase margin at unity gain $R_L = 50\text{ k}\Omega$ ‡, $C_L = 100\text{ pF}$ ‡	25°C	63°			63°			
		25°C	15			15			dB

† Full range is – 40°C to 125°C for Q suffix, – 55°C to 125°C for M suffix.

‡ Referenced to 2.5 V

TLC225x, TLC225xA
Advanced LinCMOS™ RAIL-TO-RAIL
VERY LOW-POWER OPERATIONAL AMPLIFIERS

SLOS176D – FEBRUARY 1997 – REVISED MARCH 2001

electrical characteristics at specified free-air temperature, $V_{DD\pm} = \pm 5$ V (unless otherwise noted)

PARAMETER	TEST CONDITIONS	T_A †	TLC2252Q TLC2252M			TLC2252AQ TLC2252AM			UNIT
			MIN	TYP	MAX	MIN	TYP	MAX	
V_{IO} Input offset voltage	$V_{IC} = 0, V_O = 0, R_S = 50 \Omega$	25°C	200	1500		200	850	μV	
		Full range			1750		1000		
αV_{IO} Temperature coefficient of input offset voltage		25°C to 125°C	0.5			0.5		$\mu V/^\circ C$	
Input offset voltage long-term drift (see Note 4)		25°C	0.003			0.003		$\mu V/mo$	
I_{IO} Input offset current		25°C	0.5	60		0.5	60	pA	
		Full range			1000		1000		
I_{IB} Input bias current	25°C	1	60		1	60	pA		
	Full range			1000		1000			
V_{ICR} Common-mode input voltage range	$R_S = 50 \Omega, V_{IO} \leq 5 mV$	25°C	-5 to 4	-5.3 to 4.2		-5 to 4	-5.3 to 4.2	V	
		Full range	-5 to 3.5			-5 to 3.5			
V_{OM+} Maximum positive peak output voltage	$I_O = -20 \mu A$	25°C	4.98			4.98	V		
		25°C	4.9	4.93		4.9		4.93	
		Full range	4.7			4.7			
		25°C	4.8	4.86		4.8		4.86	
V_{OM-} Maximum negative peak output voltage	$V_{IC} = 0, I_O = 50 \mu A$	25°C	-4.99			-4.99	V		
		25°C	-4.85	-4.91		-4.85		-4.91	
	Full range	-4.85			-4.85				
	$V_{IC} = 0, I_O = 500 \mu A$	25°C	-4	-4.3		-4		-4.3	
		Full range	-3.8			-3.8			
	$V_{IC} = 0, I_O = 4 mA$	25°C							
Full range									
25°C									
AVD Large-signal differential voltage amplification	$V_O = \pm 4 V$	$R_L = 100 k\Omega$	25°C	40	150		40	150	V/mV
			Full range	10			10		
		$R_L = 1 M\Omega$	25°C	3000			3000		
r_{id} Differential input resistance		25°C	10^{12}			10^{12}	Ω		
r_{ic} Common-mode input resistance		25°C	10^{12}			10^{12}	Ω		
c_{ic} Common-mode input capacitance	$f = 10 kHz, P$ package	25°C	8			8	pF		
z_o Closed-loop output impedance	$f = 25 kHz, A_V = 10$	25°C	190			190	Ω		
CMRR Common-mode rejection ratio	$V_{IC} = -5 V$ to 2.7 V, $V_O = 0, R_S = 50 \Omega$	25°C	75	88		75	88	dB	
		Full range	75			75			
k_{SVR} Supply-voltage rejection ratio ($\Delta V_{DD\pm} / \Delta V_{IO}$)	$V_{DD} = \pm 2.2 V$ to $\pm 8 V, V_{IC} = 0, No$ load	25°C	80	95		80	95	dB	
		Full range	80			80			
I_{DD} Supply current	$V_O = 2.5 V, No$ load	25°C	80	125		80	125	μA	
		Full range			150		150		

† Full range is -40°C to 125°C for Q suffix, -55°C to 125°C for M suffix.

NOTE 4: Typical values are based on the input offset voltage shift observed through 500 hours of operating life test at $T_A = 150^\circ C$ extrapolated to $T_A = 25^\circ C$ using the Arrhenius equation and assuming an activation energy of 0.96 eV.

TLC225x, TLC225xA
Advanced LinCMOS™ RAIL-TO-RAIL
VERY LOW-POWER OPERATIONAL AMPLIFIERS

SLOS176D – FEBRUARY 1997 – REVISED MARCH 2001

operating characteristics at specified free-air temperature, $V_{DD\pm} = \pm 5\text{ V}$

PARAMETER	TEST CONDITIONS	T_A †	TLC2252Q TLC2252M			TLC2252AQ TLC2252AM			UNIT
			MIN	TYP	MAX	MIN	TYP	MAX	
SR	Slew rate at unity gain $V_O = \pm 2\text{ V}$, $C_L = 100\text{ pF}$, $R_L = 100\text{ k}\Omega$	25°C	0.07	0.12		0.07	0.12		$\text{V}/\mu\text{s}$
		Full range	0.05			0.05			
V_n	Equivalent input noise voltage	25°C		38			38		$\text{nV}/\sqrt{\text{Hz}}$
		25°C		19			19		
$V_{N(PP)}$	Peak-to-peak equivalent input noise voltage	25°C		0.8			0.8		μV
		25°C		1.1			1.1		
I_n	Equivalent input noise current	25°C		0.6			0.6	$\text{fA}/\sqrt{\text{Hz}}$	
THD + N	Total harmonic distortion plus noise $V_O = \pm 2.3\text{ V}$, $R_L = 50\text{ k}\Omega$, $f = 10\text{ kHz}$	25°C		0.2%			0.2%		
				1%			1%		
	Gain-bandwidth product $f = 10\text{ kHz}$, $C_L = 100\text{ pF}$, $R_L = 50\text{ k}\Omega$	25°C		0.21			0.21	MHz	
BOM	Maximum output-swing bandwidth $V_{O(PP)} = 4.6\text{ V}$, $R_L = 50\text{ k}\Omega$, $A_V = 1$, $C_L = 100\text{ pF}$	25°C		14			14	kHz	
ϕ_m	Phase margin at unity gain $R_L = 50\text{ k}\Omega$, $C_L = 100\text{ pF}$	25°C		63°			63°		
		25°C		15			15	dB	

† Full range is – 40°C to 125°C for Q suffix, – 55°C to 125°C for M suffix.

TLC225x, TLC225xA
Advanced LinCMOS™ RAIL-TO-RAIL
VERY LOW-POWER OPERATIONAL AMPLIFIERS

SLOS176D – FEBRUARY 1997 – REVISED MARCH 2001

electrical characteristics at specified free-air temperature, $V_{DD} = 5\text{ V}$ (unless otherwise noted)

PARAMETER	TEST CONDITIONS	T_A †	TLC2254Q TLC2254M			TLC2254AQ TLC2254AM			UNIT	
			MIN	TYP	MAX	MIN	TYP	MAX		
V_{IO} Input offset voltage		25°C	200	1500		200	850	μV		
		Full range		1750		1000				
αV_{IO} Temperature coefficient of input offset voltage		25°C to 125°C	0.5			0.5			$\mu\text{V}/^\circ\text{C}$	
Input offset voltage long-term drift (see Note 4)	$V_{DD\pm} = \pm 2.5\text{ V}$, $V_O = 0$, $V_{IC} = 0$, $R_S = 50\ \Omega$	25°C	0.003			0.003			$\mu\text{V}/\text{mo}$	
I_{IO} Input offset current		25°C	0.5	60		0.5	60	pA		
		125°C	1000			1000				
I_{IB} Input bias current		25°C	1	60		1	60	pA		
		125°C	1000			1000				
V_{ICR} Common-mode input voltage range	$R_S = 50\ \Omega$, $ V_{IO} \leq 5\text{ mV}$	25°C	0 to 4	-0.3 to 4.2		0 to 4	-0.3 to 4.2	V		
		Full range	0 to 3.5		0 to 3.5					
V_{OH} High-level output voltage	$I_{OH} = -20\ \mu\text{A}$	25°C	4.98			4.98			V	
	$I_{OH} = -75\ \mu\text{A}$	25°C	4.9	4.94		4.9	4.94			
		Full range	4.8			4.8				
	$I_{OH} = -150\ \mu\text{A}$	25°C	4.8	4.88		4.8	4.88			
V_{OL} Low-level output voltage	$V_{IC} = 2.5\text{ V}$, $I_{OL} = 50\ \mu\text{A}$	25°C	0.01			0.01			V	
	$V_{IC} = 2.5\text{ V}$, $I_{OL} = 500\ \mu\text{A}$	25°C	0.09	0.15		0.09	0.15			
		Full range	0.15			0.15				
	$V_{IC} = 2.5\text{ V}$, $I_{OL} = 4\text{ mA}$	25°C	0.8	1		0.7	1			
		Full range	1.2			1.2				
A_{VD} Large-signal differential voltage amplification	$V_{IC} = 2.5\text{ V}$, $V_O = 1\text{ V to } 4\text{ V}$	$R_L = 100\text{ k}\Omega$ ‡	25°C	100	350		100	350	V/mV	
			Full range	10			10			
		$R_L = 1\text{ M}\Omega$ ‡	25°C	1700			1700			
$r_{i(d)}$ Differential input resistance		25°C	1012			1012			Ω	
$r_{i(c)}$ Common-mode input resistance		25°C	1012			1012			Ω	
$C_{i(c)}$ Common-mode input capacitance	$f = 10\text{ kHz}$, N package	25°C	8			8			pF	
z_o Closed-loop output impedance	$f = 25\text{ kHz}$, $A_V = 10$	25°C	200			200			Ω	
CMRR Common-mode rejection ratio	$V_{IC} = 0\text{ to } 2.7\text{ V}$, $V_O = 2.5\text{ V}$, $R_S = 50\ \Omega$	25°C	70	83		70	83	dB		
		Full range	70			70				
k_{SVR} Supply-voltage rejection ratio ($\Delta V_{DD}/\Delta V_{IO}$)	$V_{DD} = 4.4\text{ V to } 16\text{ V}$, $V_{IC} = V_{DD}/2$, No load	25°C	80	95		80	95	dB		
		Full range	80			80				
I_{DD} Supply current (four amplifiers)	$V_O = 2.5\text{ V}$, No load	25°C	140	250		140	250	μA		
		Full range	300			300				

† Full range is -40°C to 125°C for Q suffix, -55°C to 125°C for M suffix.

‡ Referenced to 2.5 V

NOTE 4: Typical values are based on the input offset voltage shift observed through 500 hours of operating life test at $T_A = 150^\circ\text{C}$ extrapolated to $T_A = 25^\circ\text{C}$ using the Arrhenius equation and assuming an activation energy of 0.96 eV.

TLC225x, TLC225xA
Advanced LinCMOS™ RAIL-TO-RAIL
VERY LOW-POWER OPERATIONAL AMPLIFIERS

SLOS176D – FEBRUARY 1997 – REVISED MARCH 2001

operating characteristics at specified free-air temperature, $V_{DD} = 5\text{ V}$

PARAMETER	TEST CONDITIONS	T_A †	TLC2254Q TLC2254M			TLC2254AQ TLC2254AM			UNIT
			MIN	TYP	MAX	MIN	TYP	MAX	
SR	Slew rate at unity gain $V_O = 0.5\text{ V to }3.5\text{ V}$, $R_L = 100\text{ k}\Omega$ ‡, $C_L = 100\text{ pF}$ ‡	25°C	0.07	0.12		0.07	0.12		$\text{V}/\mu\text{s}$
		Full range	0.05			0.05			
V_n	Equivalent input noise voltage $f = 10\text{ Hz}$ $f = 1\text{ kHz}$	25°C	36			36			$\text{nV}/\sqrt{\text{Hz}}$
		25°C	19			19			
$V_{N(PP)}$	Peak-to-peak equivalent input noise voltage $f = 0.1\text{ Hz to }1\text{ Hz}$ $f = 0.1\text{ Hz to }10\text{ Hz}$	25°C	0.7			0.7			μV
		25°C	1.1			1.1			
I_n	Equivalent input noise current	25°C	0.6			0.6			$\text{fA}/\sqrt{\text{Hz}}$
THD + N	Total harmonic distortion plus noise $V_O = 0.5\text{ V to }2.5\text{ V}$, $f = 20\text{ kHz}$, $R_L = 50\text{ k}\Omega$ ‡	$A_V = 1$	0.2%			0.2%			
		$A_V = 10$	1%			1%			
	Gain-bandwidth product $f = 50\text{ kHz}$, $C_L = 100\text{ pF}$ ‡	$R_L = 50\text{ k}\Omega$ ‡, 25°C	0.2			0.2			MHz
B_{OM}	Maximum output-swing bandwidth $V_{O(PP)} = 2\text{ V}$, $R_L = 50\text{ k}\Omega$ ‡, $A_V = 1$, $C_L = 100\text{ pF}$ ‡	25°C	30			30			kHz
ϕ_m	Phase margin at unity gain $R_L = 50\text{ k}\Omega$ ‡, $C_L = 100\text{ pF}$ ‡	25°C	63°			63°			
		25°C	15			15			dB

† Full range is – 40°C to 125°C for Q suffix, – 55°C to 125°C for M suffix.

‡ Referenced to 2.5 V

TLC225x, TLC225xA
Advanced LinCMOS™ RAIL-TO-RAIL
VERY LOW-POWER OPERATIONAL AMPLIFIERS

SLOS176D – FEBRUARY 1997 – REVISED MARCH 2001

electrical characteristics at specified free-air temperature, $V_{DD\pm} = \pm 5$ V (unless otherwise noted)

PARAMETER	TEST CONDITIONS	T_A †	TLC2254Q TLC2254M			TLC2254AQ TLC2254AM			UNIT
			MIN	TYP	MAX	MIN	TYP	MAX	
V_{IO} Input offset voltage	$V_{IC} = 0, V_O = 0, R_S = 50 \Omega$	25°C	200	1500		200	850	μV	
		Full range			1750		1000		
αV_{IO} Temperature coefficient of input offset voltage		25°C to 125°C	0.5			0.5		$\mu V/^\circ C$	
Input offset voltage long-term drift (see Note 4)		25°C	0.003			0.003		$\mu V/mo$	
I_{IO} Input offset current		25°C	0.5	60		0.5	60	pA	
		125°C			1000		1000		
I_{IB} Input bias current	25°C	1	60		1	60	pA		
	125°C			1000		1000			
V_{ICR} Common-mode input voltage range	$R_S = 50 \Omega, V_{IO} \leq 5 mV$	25°C	-5 to 4	-5.3 to 4.2		-5 to 4	-5.3 to 4.2	V	
		Full range	-5 to 3.5			-5 to 3.5			
V_{OM+} Maximum positive peak output voltage	$I_O = -20 \mu A$	25°C	4.98			4.98	V		
	$I_O = -100 \mu A$	25°C	4.9	4.93		4.9		4.93	
		Full range	4.7			4.7			
V_{OM-} Maximum negative peak output voltage	$I_O = -200 \mu A$	25°C	4.8	4.86		4.8	4.86	V	
	$V_{IC} = 0, I_O = 50 \mu A$	25°C	-4.99			-4.99			
		Full range	-4.85	-4.91		-4.85	-4.91		
	$V_{IC} = 0, I_O = 500 \mu A$	25°C	-4.85	-4.91		-4.85	-4.91		
		Full range	-4.85			-4.85			
$V_{IC} = 0, I_O = 4 mA$	25°C	-4	-4.3		-4	-4.3			
	Full range	-3.8			-3.8				
AVD Large-signal differential voltage amplification	$V_O = \pm 4 V$	$R_L = 100 k\Omega$	25°C	40	150		40	150	V/mV
			Full range	10			10		
		$R_L = 1 M\Omega$	25°C	3000			3000		
$r_{i(d)}$ Differential input resistance		25°C	1012			1012	Ω		
$r_{i(c)}$ Common-mode input resistance		25°C	1012			1012	Ω		
$c_{i(c)}$ Common-mode input capacitance	$f = 10 kHz, N$ package	25°C	8			8	pF		
z_o Closed-loop output impedance	$f = 25 kHz, A_V = 10$	25°C	190			190	Ω		
CMRR Common-mode rejection ratio	$V_{IC} = -5 V$ to 2.7 V, $V_O = 0, R_S = 50 \Omega$	25°C	75	88		75	88	dB	
		Full range	75			75			
k_{SVR} Supply-voltage rejection ratio ($\Delta V_{DD\pm} / \Delta V_{IO}$)	$V_{DD\pm} = \pm 2.2 V$ to $\pm 8 V, V_{IC} = V_{DD}/2, No load$	25°C	80	95		80	95	dB	
		Full range	80			80			
I_{DD} Supply current (four amplifiers)	$V_O = 0, No load$	25°C	160	250		160	250	μA	
		Full range			300		300		

† Full range is -40°C to 125°C for Q suffix, -55°C to 125°C for M suffix.

NOTE 4: Typical values are based on the input offset voltage shift observed through 500 hours of operating life test at $T_A = 150^\circ C$ extrapolated to $T_A = 25^\circ C$ using the Arrhenius equation and assuming an activation energy of 0.96 eV.

TLC225x, TLC225xA
Advanced LinCMOS™ RAIL-TO-RAIL
VERY LOW-POWER OPERATIONAL AMPLIFIERS

SLOS176D – FEBRUARY 1997 – REVISED MARCH 2001

operating characteristics at specified free-air temperature, $V_{DD\pm} = \pm 5\text{ V}$

PARAMETER	TEST CONDITIONS		T_A †	TLC2254Q TLC2254M			TLC2254AQ TLC2254AM			UNIT
				MIN	TYP	MAX	MIN	TYP	MAX	
SR Slew rate at unity gain	$V_O = \pm 2\text{ V}$, $C_L = 100\text{ pF}$	$R_L = 100\text{ k}\Omega$,	25°C	0.07	0.12		0.07	0.12	$\text{V}/\mu\text{s}$	
			Full range	0.05			0.05			
V_n Equivalent input noise voltage	$f = 10\text{ Hz}$		25°C	38			38			$\text{nV}/\sqrt{\text{Hz}}$
	$f = 1\text{ kHz}$		25°C	19			19			
$V_{N(PP)}$ Peak-to-peak equivalent input noise voltage	$f = 0.1\text{ Hz to }1\text{ Hz}$		25°C	0.8			0.8			μV
	$f = 0.1\text{ Hz to }10\text{ Hz}$		25°C	1.1			1.1			
I_n Equivalent input noise current			25°C	0.6			0.6			$\text{fA}/\sqrt{\text{Hz}}$
THD + N Total harmonic distortion plus noise	$V_O = \pm 2.3\text{ V}$, $R_L = 50\text{ k}\Omega$, $f = 20\text{ kHz}$	$A_V = 1$	25°C	0.2%			0.2%			
		$A_V = 10$		1%			1%			
Gain-bandwidth product	$f = 10\text{ kHz}$, $C_L = 100\text{ pF}$	$R_L = 50\text{ k}\Omega$,	25°C	0.21			0.21			MHz
B_{OM} Maximum output-swing bandwidth	$V_{O(PP)} = 4.6\text{ V}$, $R_L = 50\text{ k}\Omega$,	$A_V = 1$, $C_L = 100\text{ pF}$	25°C	14			14			kHz
ϕ_m Phase margin at unity gain	$R_L = 50\text{ k}\Omega$,	$C_L = 100\text{ pF}$	25°C	63°			63°			
			Gain margin	25°C	15			15		

† Full range is – 40°C to 125°C for Q suffix, – 55°C to 125°C for M suffix.

TLC225x, TLC225xA
Advanced LinCMOS™ RAIL-TO-RAIL
VERY LOW-POWER OPERATIONAL AMPLIFIERS

SLOS176D – FEBRUARY 1997 – REVISED MARCH 2001

TYPICAL CHARACTERISTICS

Table of Graphs

		FIGURE
V_{IO}	Input offset voltage	Distribution vs Common-mode input voltage 2 – 5 6, 7
αV_{IO}	Input offset voltage temperature coefficient	Distribution 8 – 11
I_{IB}/I_{IO}	Input bias and input offset currents	vs Free-air temperature 12
V_I	Input voltage range	vs Supply voltage vs Free-air temperature 13 14
V_{OH}	High-level output voltage	vs High-level output current 15
V_{OL}	Low-level output voltage	vs Low-level output current 16, 17
V_{OM+}	Maximum positive peak output voltage	vs Output current 18
V_{OM-}	Maximum negative peak output voltage	vs Output current 19
$V_{O(PP)}$	Maximum peak-to-peak output voltage	vs Frequency 20
I_{OS}	Short-circuit output current	vs Supply voltage vs Free-air temperature 21 22
V_O	Output voltage	vs Differential input voltage 23, 24
	Differential gain	vs Load resistance 25
A_{VD}	Large-signal differential voltage amplification	vs Frequency vs Free-air temperature 26, 27 28, 29
z_o	Output impedance	vs Frequency 30, 31
CMRR	Common-mode rejection ratio	vs Frequency vs Free-air temperature 32 33
k_{SVR}	Supply-voltage rejection ratio	vs Frequency vs Free-air temperature 34, 35 36
I_{DD}	Supply current	vs Supply voltage vs Free-air temperature 37 38
SR	Slew rate	vs Load capacitance vs Free-air temperature 39 40
V_O	Inverting large-signal pulse response	41, 42
V_O	Voltage-follower large-signal pulse response	43, 44
V_O	Inverting small-signal pulse response	45, 46
V_O	Voltage-follower small-signal pulse response	47, 48
V_n	Equivalent input noise voltage	vs Frequency 49, 50
	Noise voltage (referred to input)	Over a 10-second period 51
	Integrated noise voltage	vs Frequency 52
THD + N	Total harmonic distortion plus noise	vs Frequency 53
	Gain-bandwidth product	vs Free-air temperature vs Supply voltage 54 55
ϕ_m	Phase margin	vs Frequency vs Load capacitance 26, 27 56
A_m	Gain margin	vs Load capacitance 57
B_1	Unity-gain bandwidth	vs Load capacitance 58
	Overestimation of phase margin	vs Load capacitance 59



TYPICAL CHARACTERISTICS

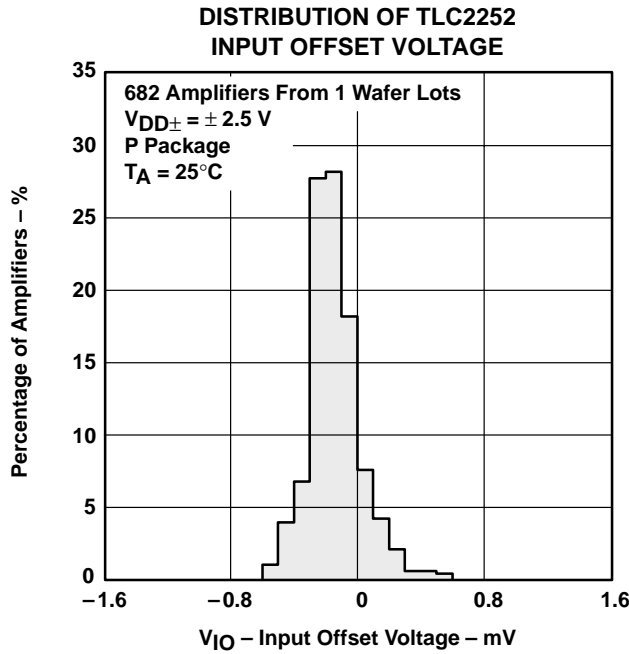

Figure 2

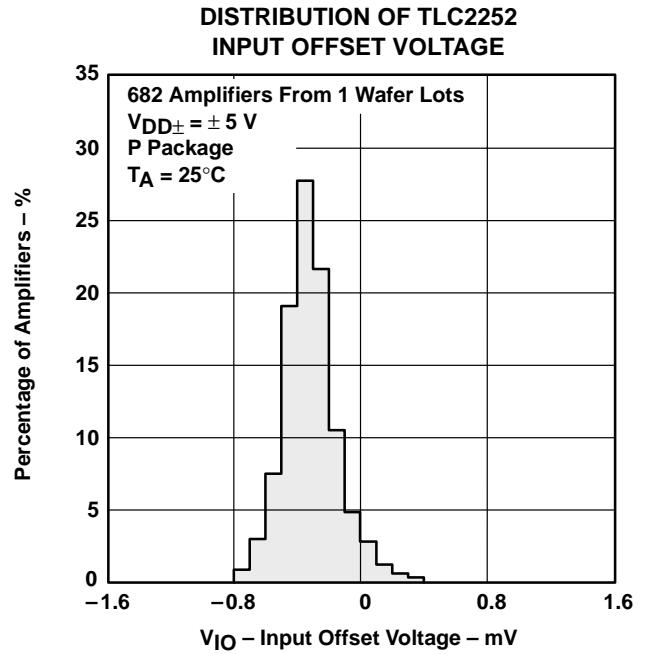

Figure 3

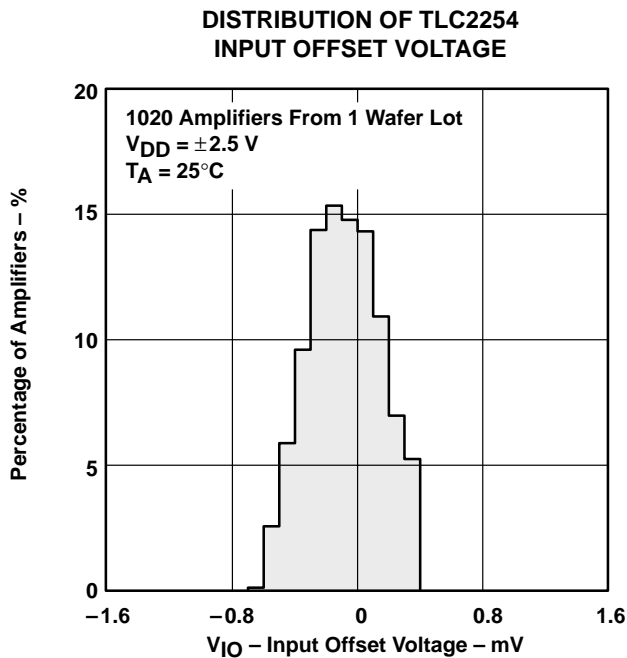

Figure 4

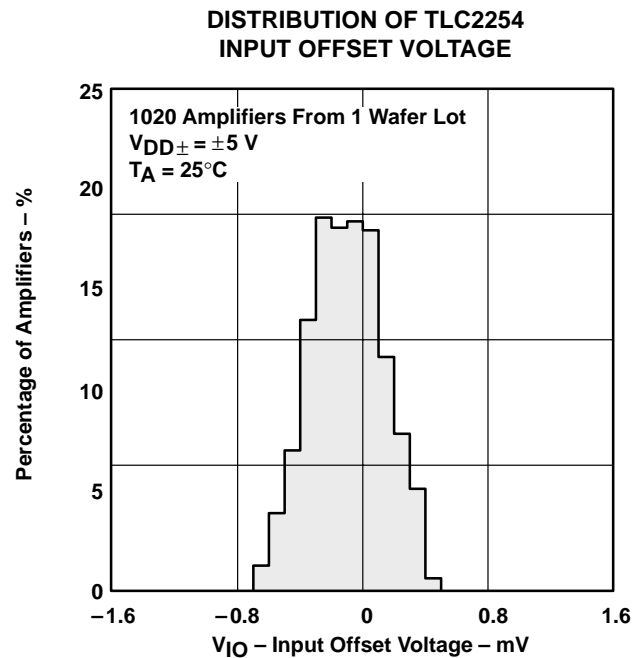

Figure 5

TYPICAL CHARACTERISTICS

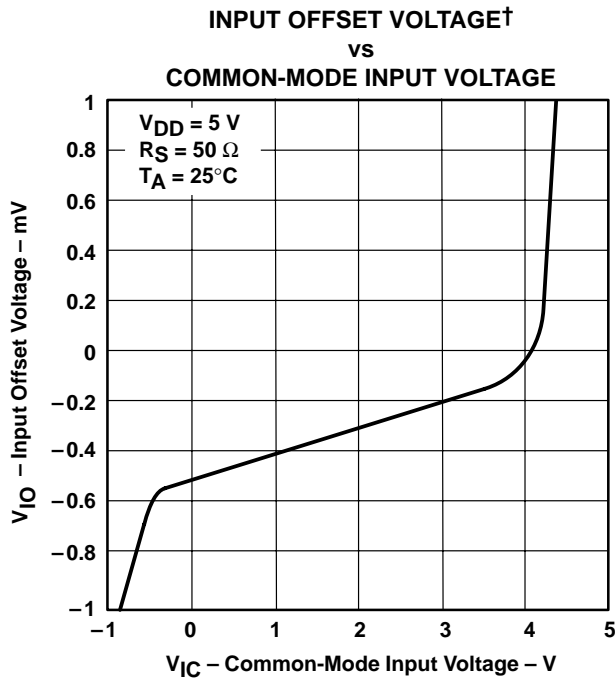

Figure 6

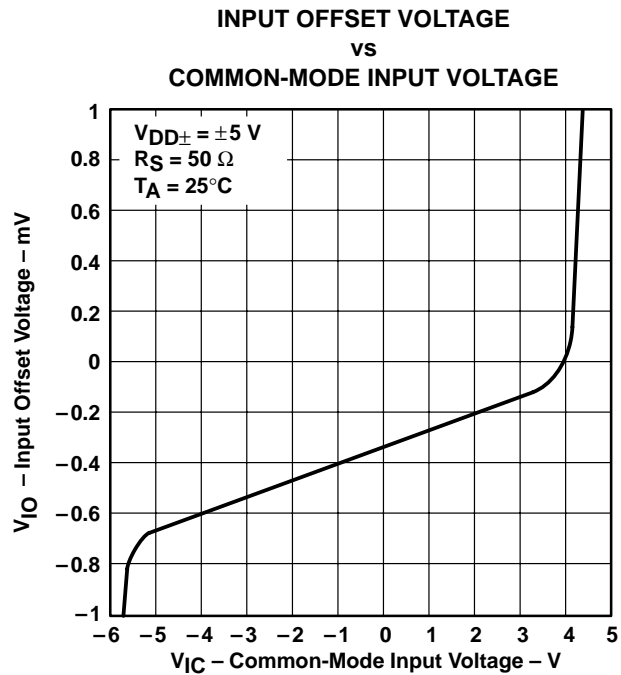

Figure 7

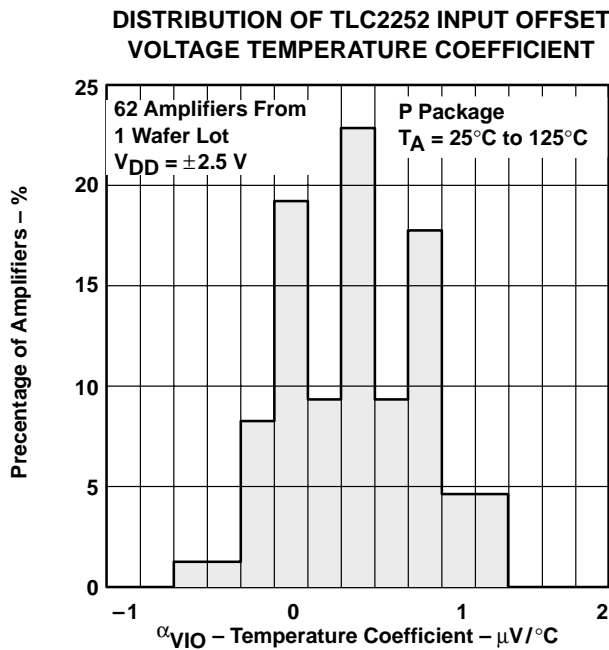

Figure 8

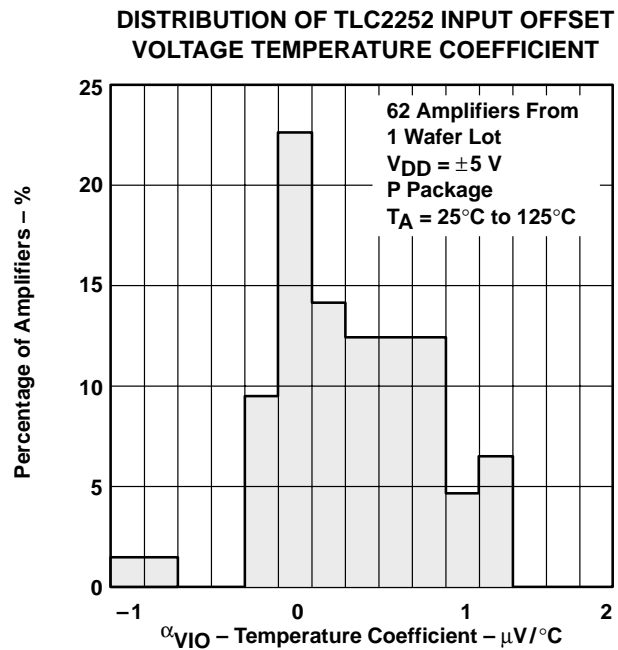

Figure 9

† For curves where $V_{DD} = 5\text{ V}$, all loads are referenced to 2.5 V.

TYPICAL CHARACTERISTICS

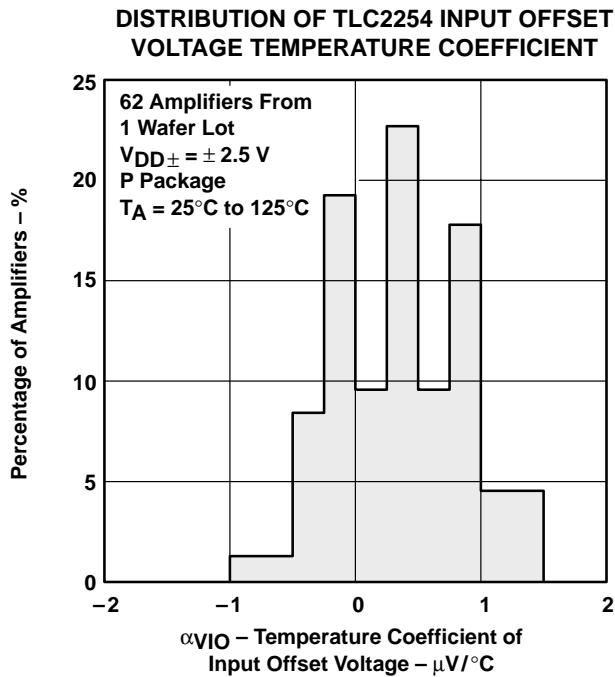

Figure 10

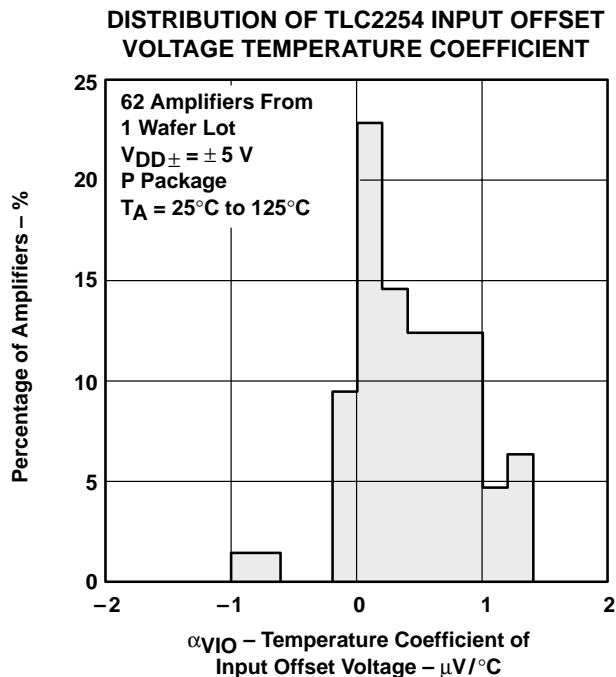

Figure 11

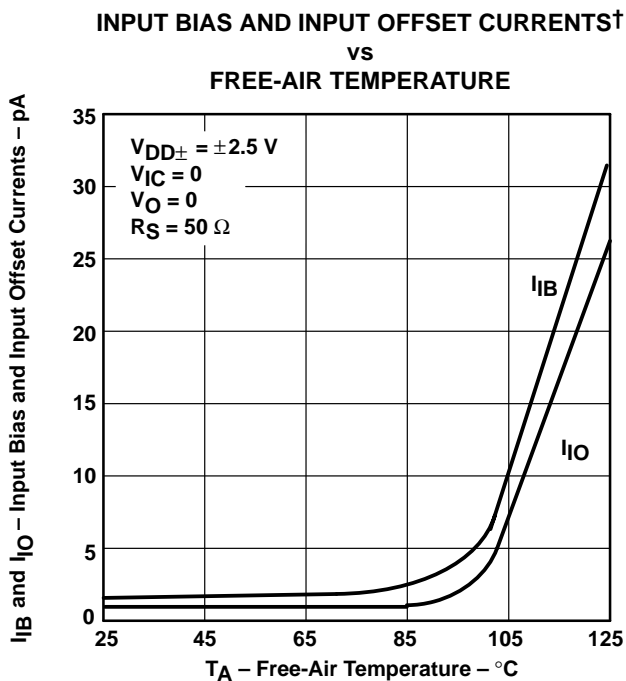

Figure 12

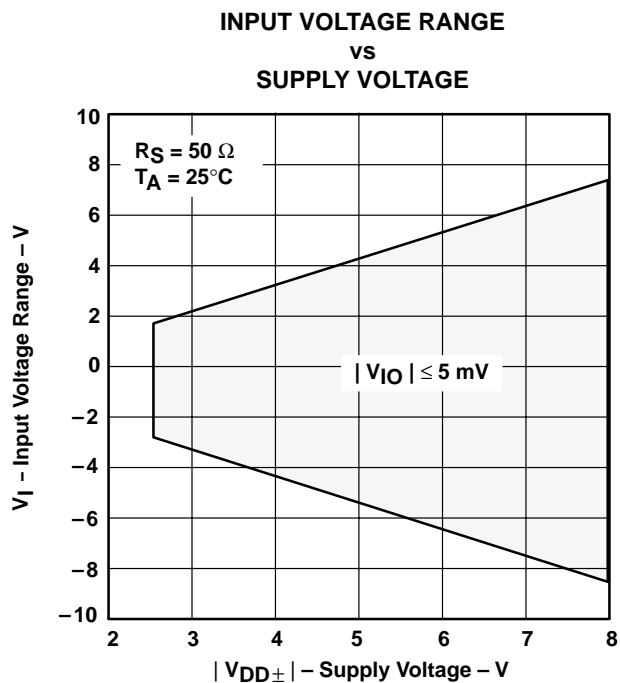
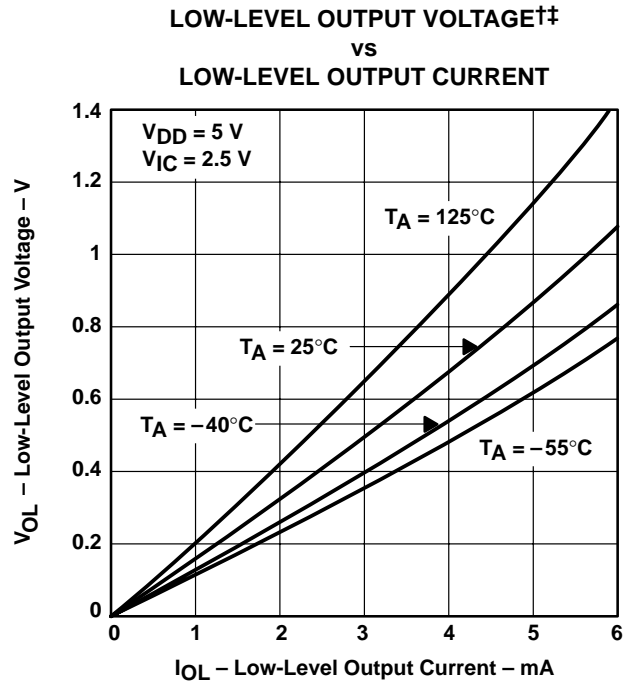
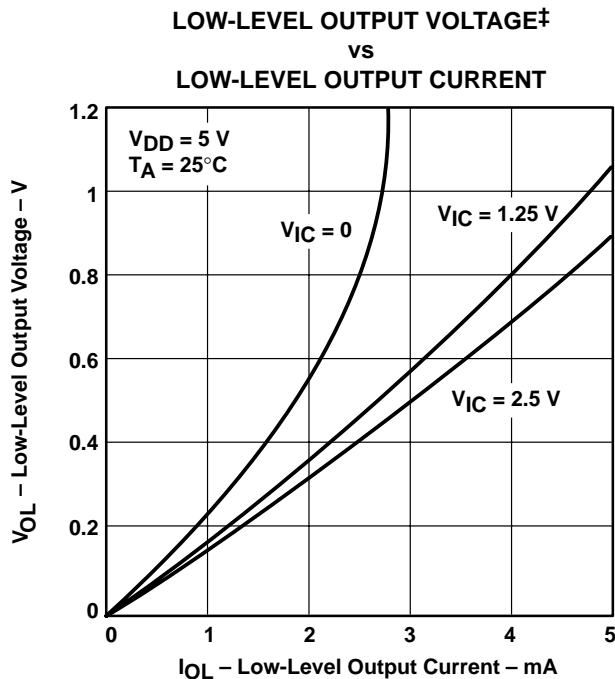
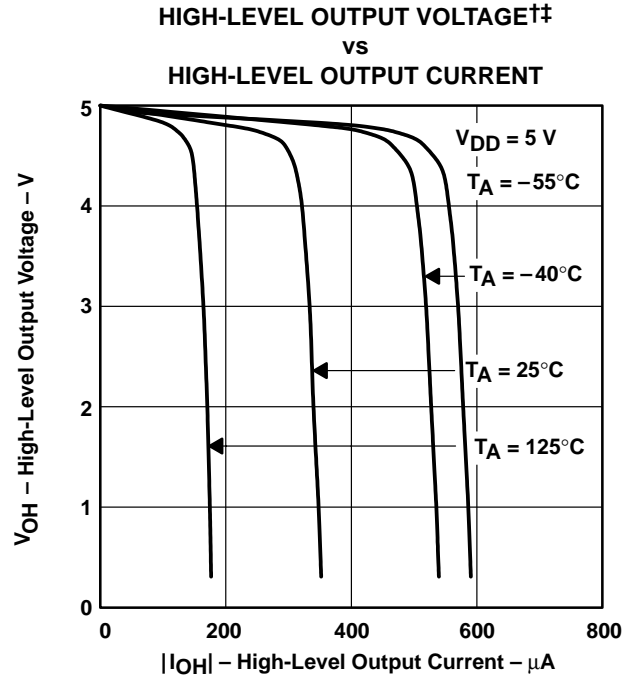
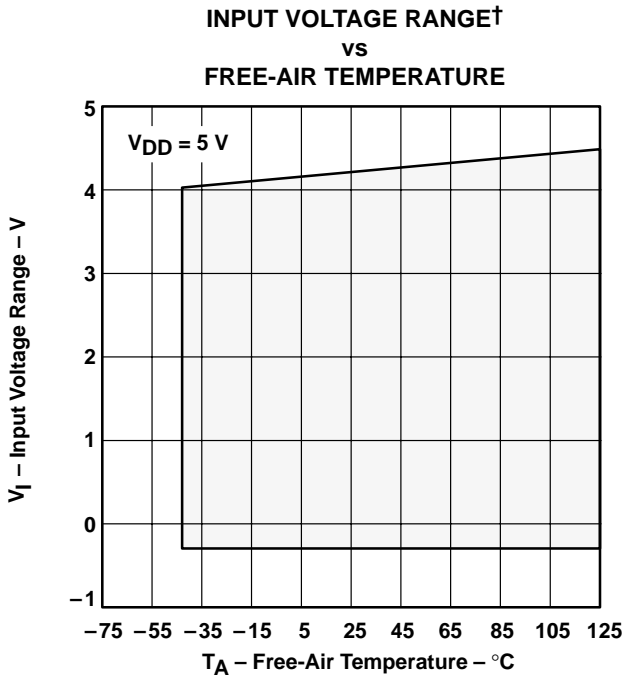

Figure 13

† Data at high and low temperatures are applicable only within the rated operating free-air temperature ranges of the various devices.

TYPICAL CHARACTERISTICS



† Data at high and low temperatures are applicable only within the rated operating free-air temperature ranges of the various devices.

‡ For curves where $V_{DD} = 5\text{ V}$, all loads are referenced to 2.5 V.

TYPICAL CHARACTERISTICS

MAXIMUM POSITIVE PEAK OUTPUT VOLTAGE†
 vs
 OUTPUT CURRENT

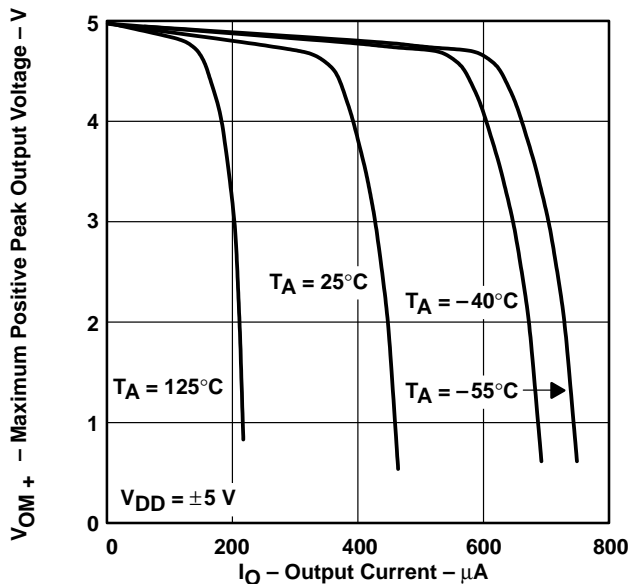

Figure 18

MAXIMUM NEGATIVE PEAK OUTPUT VOLTAGE†
 vs
 OUTPUT CURRENT

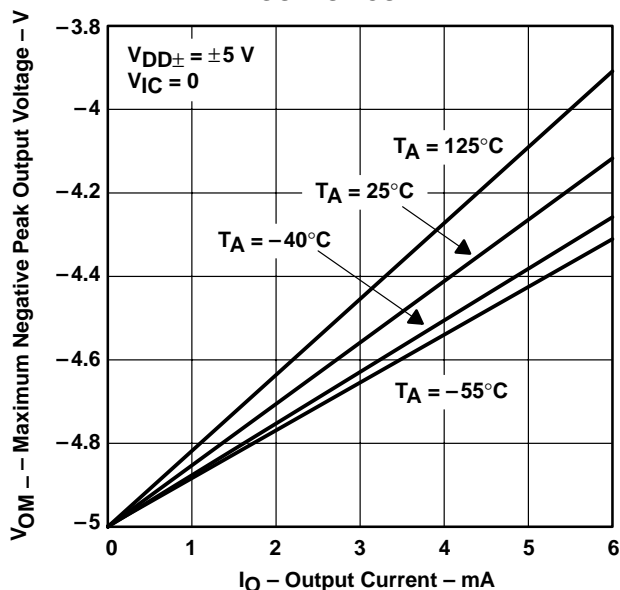

Figure 19

MAXIMUM PEAK-TO-PEAK OUTPUT VOLTAGE‡
 vs
 FREQUENCY

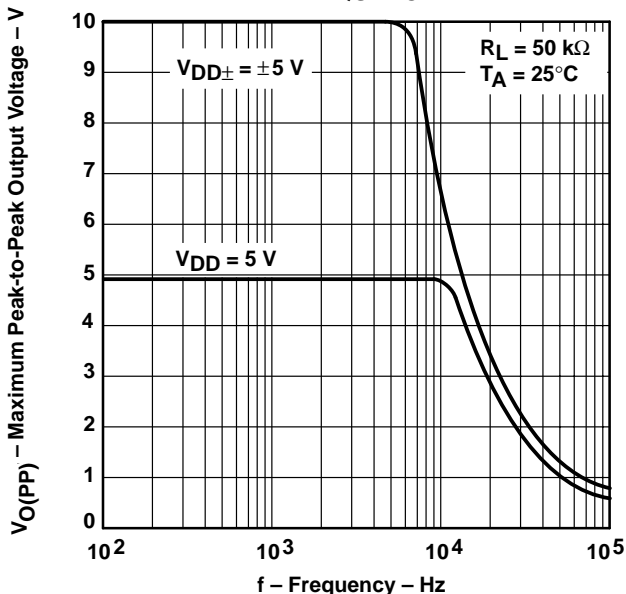

Figure 20

SHORT-CIRCUIT OUTPUT CURRENT
 vs
 SUPPLY VOLTAGE

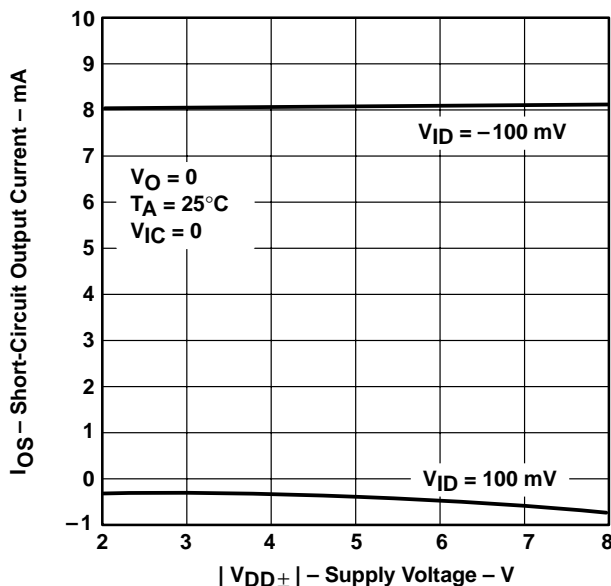

Figure 21

† Data at high and low temperatures are applicable only within the rated operating free-air temperature ranges of the various devices.
 ‡ For curves where $V_{DD} = 5\text{ V}$, all loads are referenced to 2.5 V .

TYPICAL CHARACTERISTICS

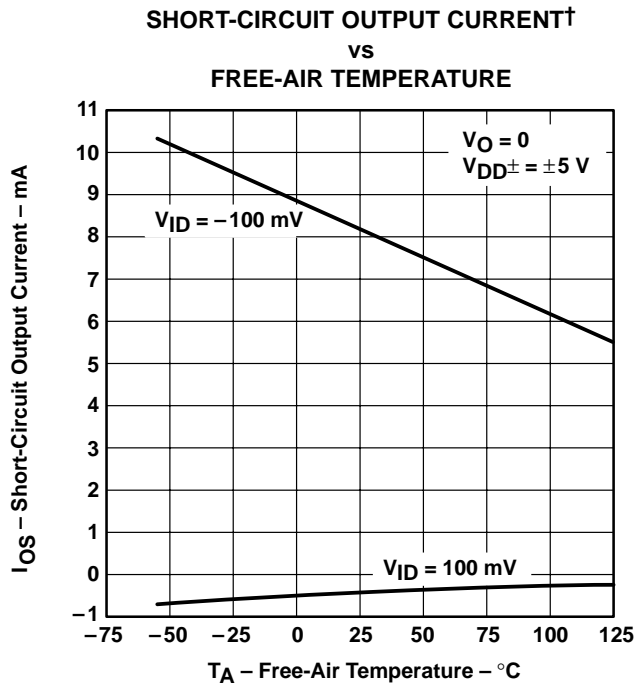

Figure 22

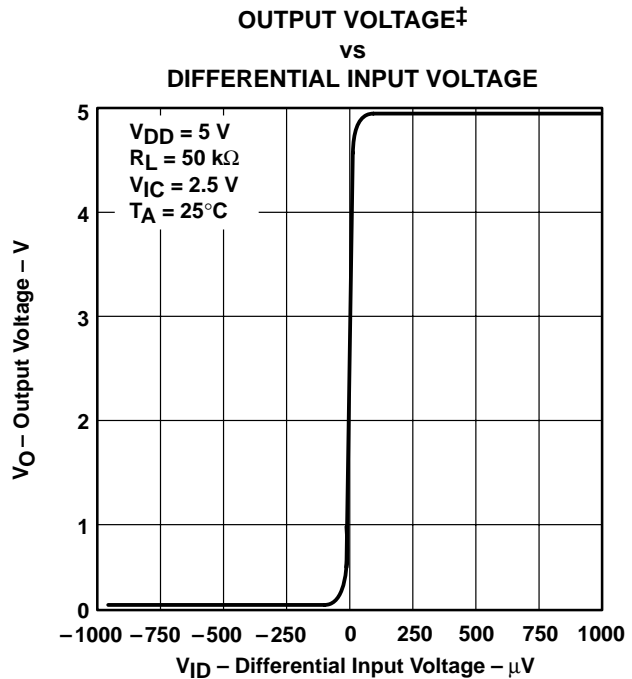

Figure 23

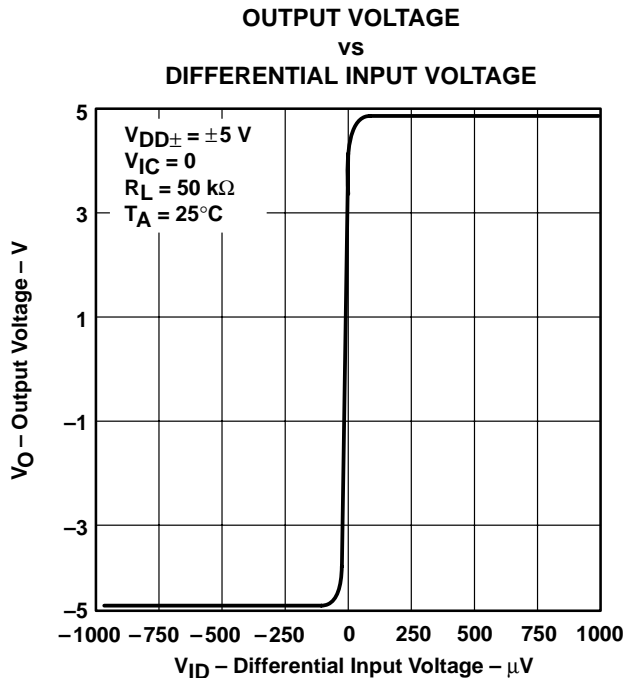

Figure 24

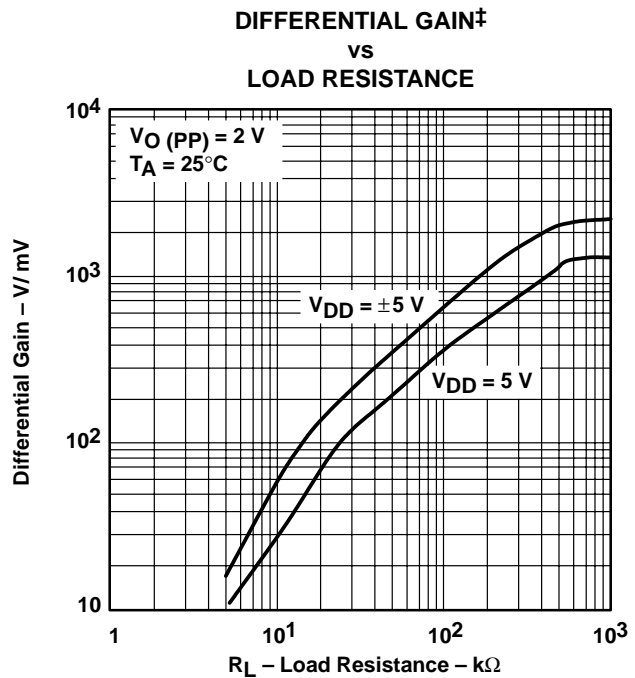

Figure 25

† Data at high and low temperatures are applicable only within the rated operating free-air temperature ranges of the various devices.
 ‡ For curves where $V_{DD} = 5\text{ V}$, all loads are referenced to 2.5 V.



TYPICAL CHARACTERISTICS

LARGE-SIGNAL DIFFERENTIAL VOLTAGE
 AMPLIFICATION AND PHASE MARGIN†
 VS
 FREQUENCY

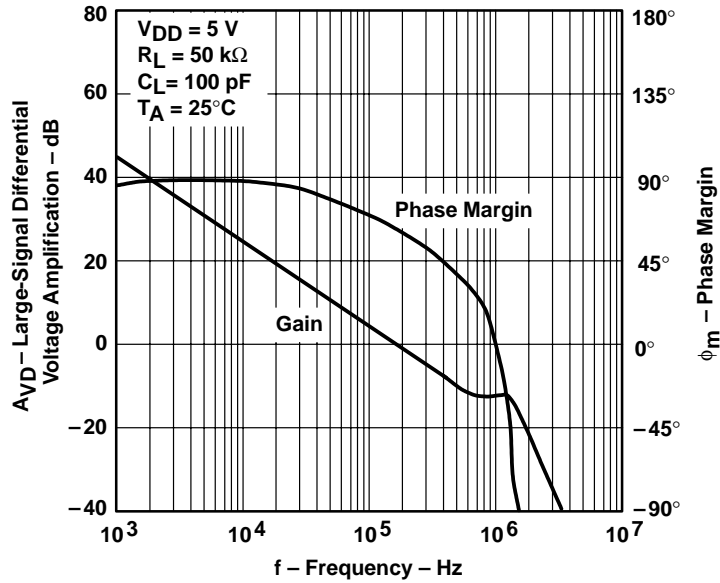

Figure 26

LARGE-SIGNAL DIFFERENTIAL VOLTAGE
 AMPLIFICATION AND PHASE MARGIN
 VS
 FREQUENCY

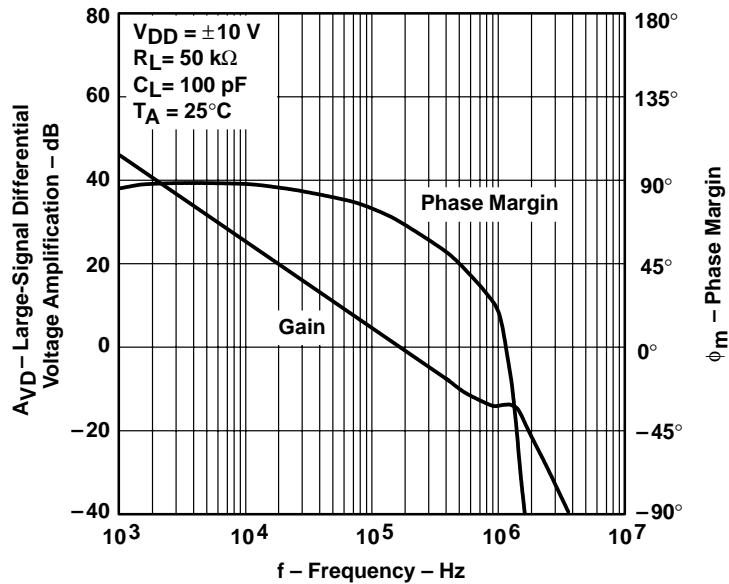
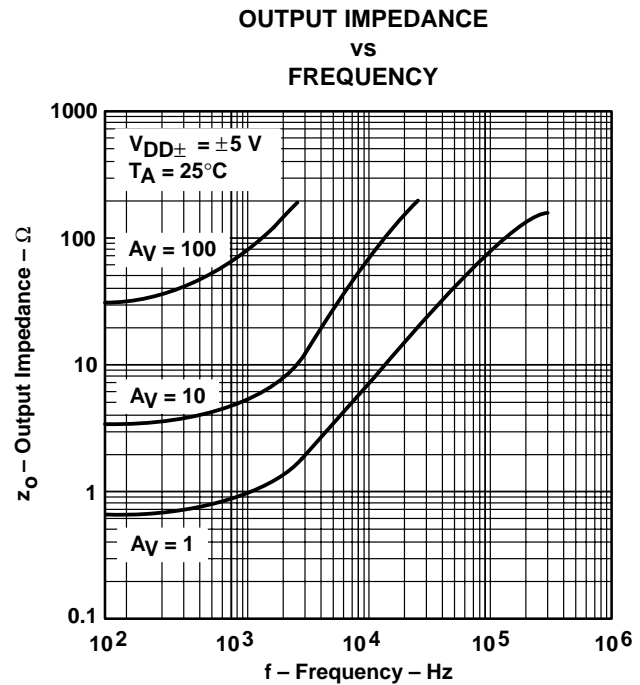
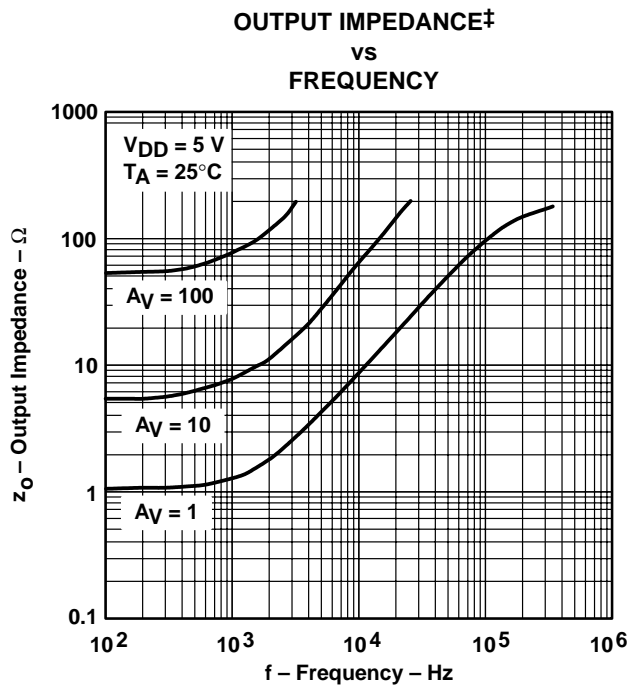
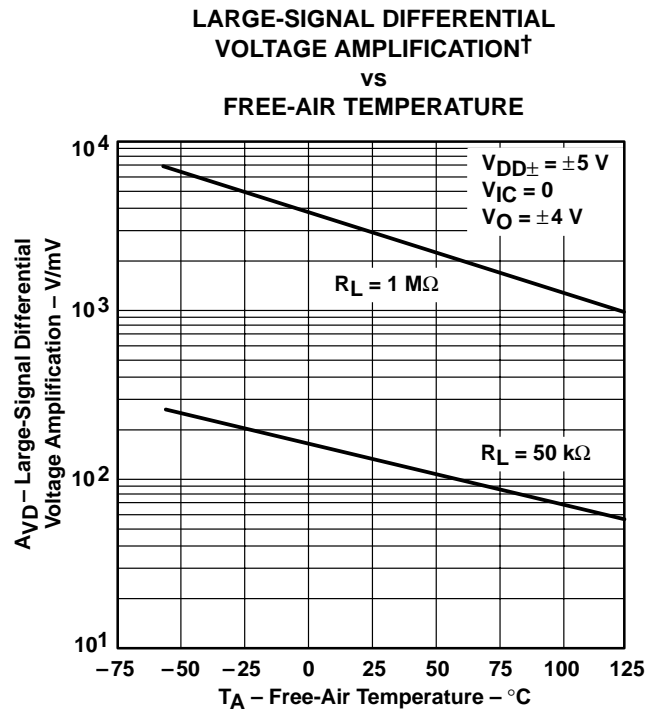
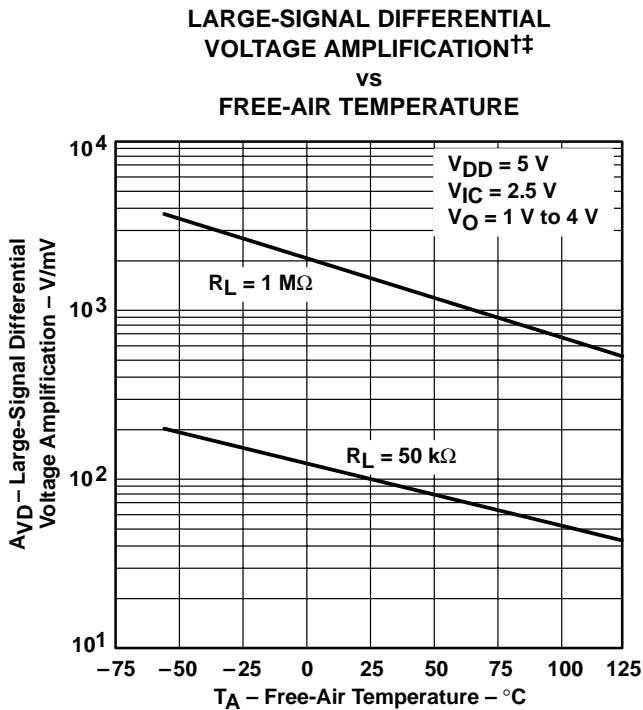

Figure 27

† For curves where $V_{DD} = 5\text{ V}$, all loads are referenced to 2.5 V.

TYPICAL CHARACTERISTICS



† Data at high and low temperatures are applicable only within the rated operating free-air temperature ranges of the various devices.
 ‡ For curves where $V_{DD} = 5\text{ V}$, all loads are referenced to 2.5 V.

TYPICAL CHARACTERISTICS

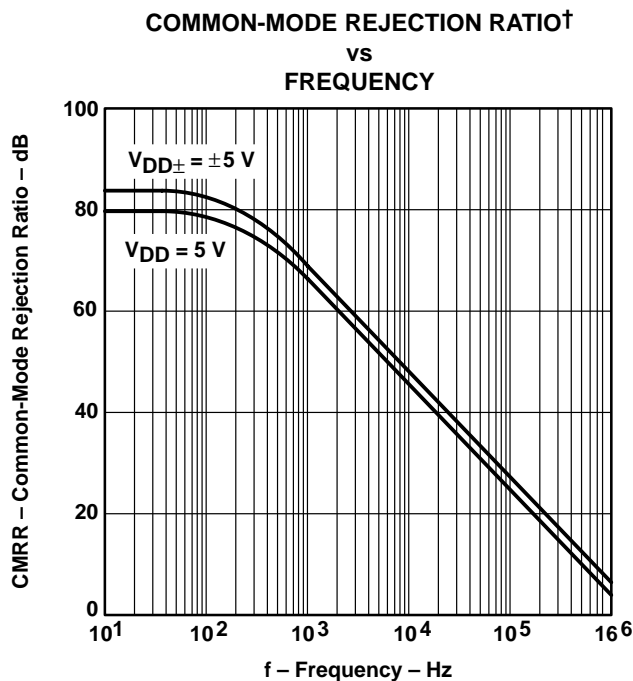

Figure 32

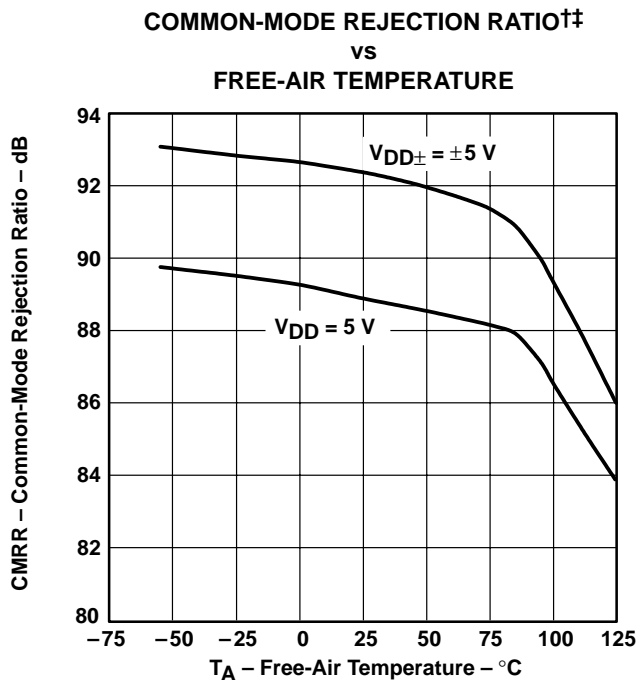

Figure 33

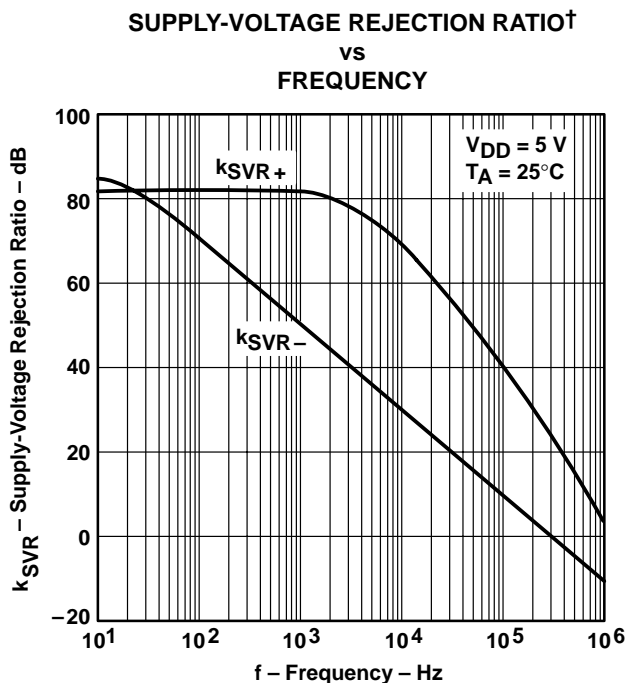

Figure 34

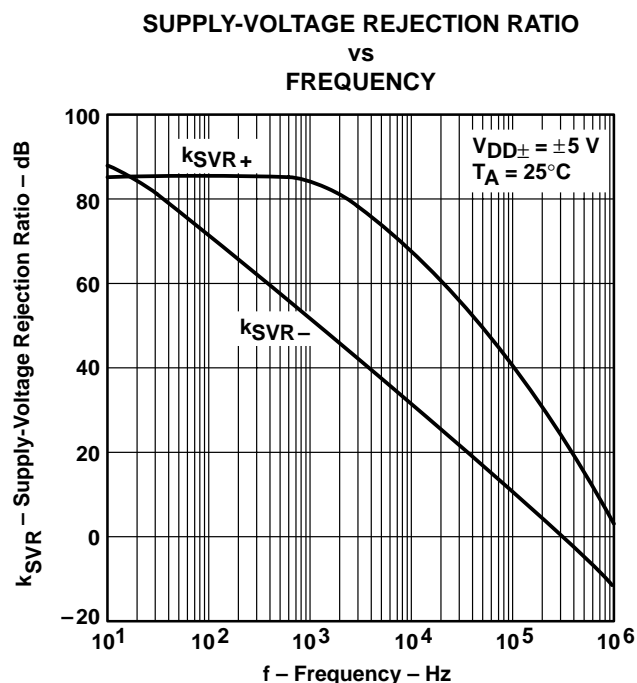

Figure 35

† For curves where $V_{DD} = 5\text{ V}$, all loads are referenced to 2.5 V.

†† Data at high and low temperatures are applicable only within the rated operating free-air temperature ranges of the various devices.

TYPICAL CHARACTERISTICS

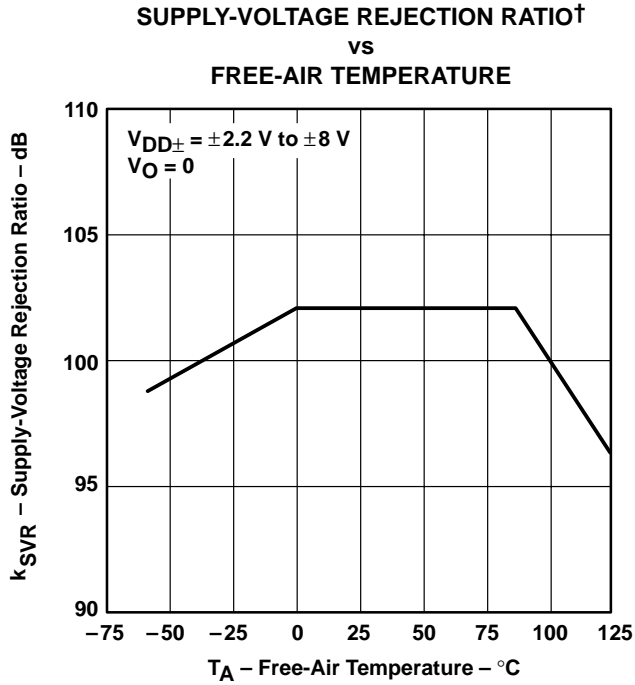

Figure 36

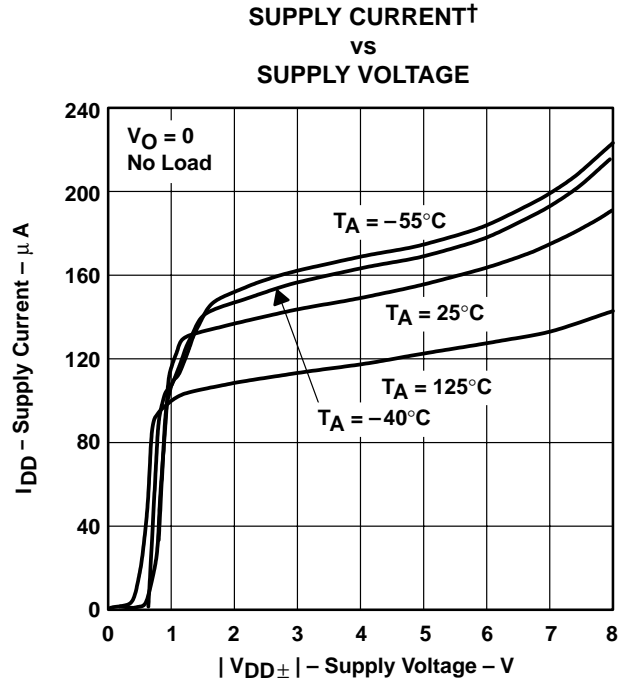

Figure 37

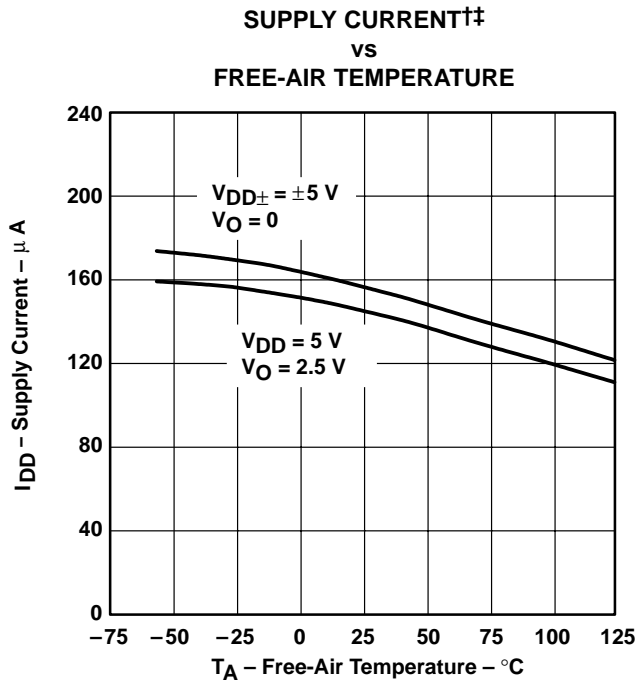

Figure 38

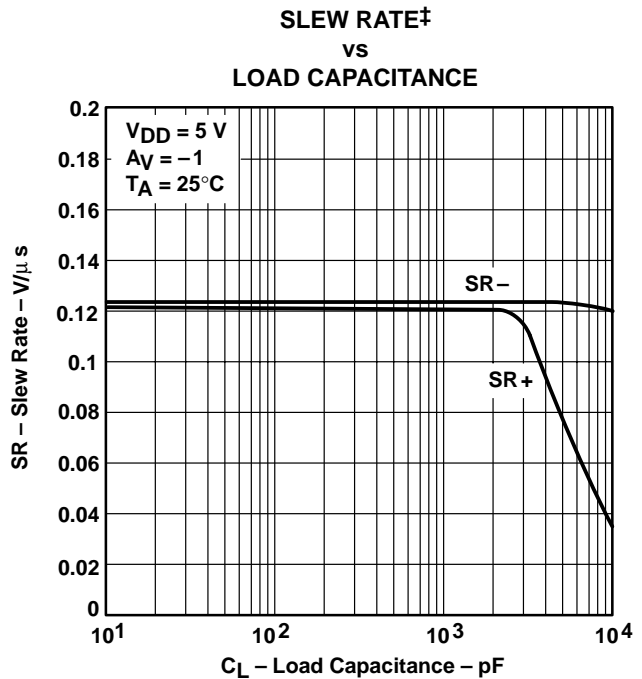

Figure 39

† Data at high and low temperatures are applicable only within the rated operating free-air temperature ranges of the various devices.

‡ For curves where $V_{DD} = 5 \text{ V}$, all loads are referenced to 2.5 V.



TYPICAL CHARACTERISTICS

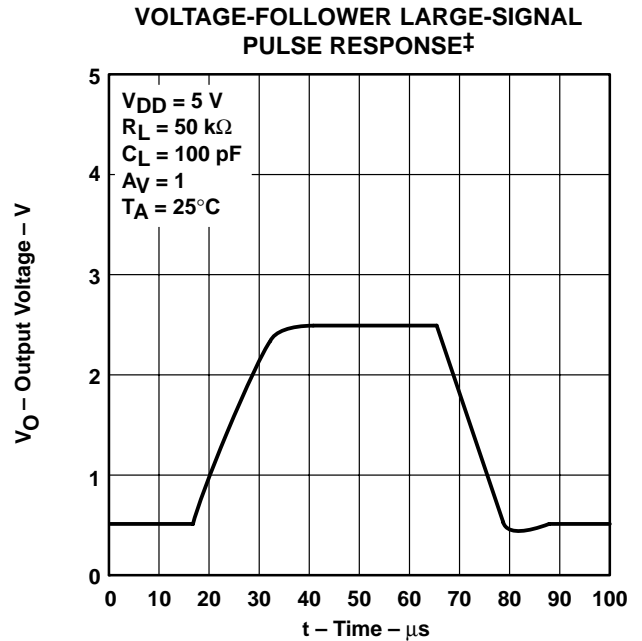
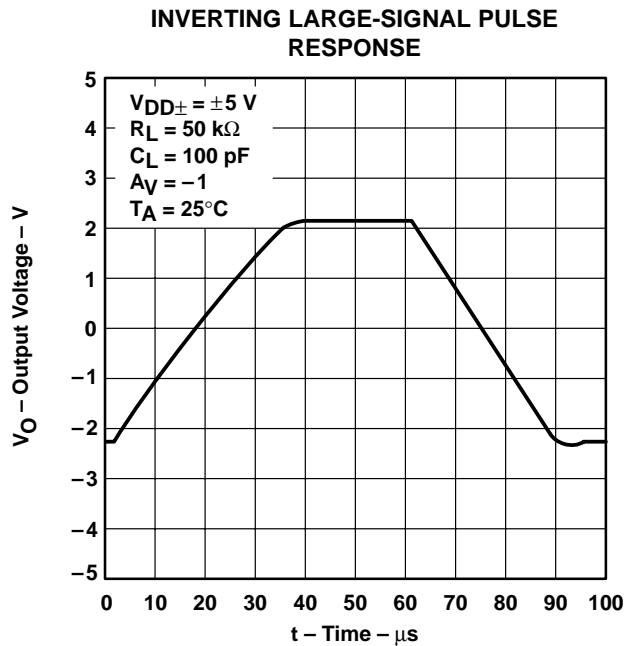
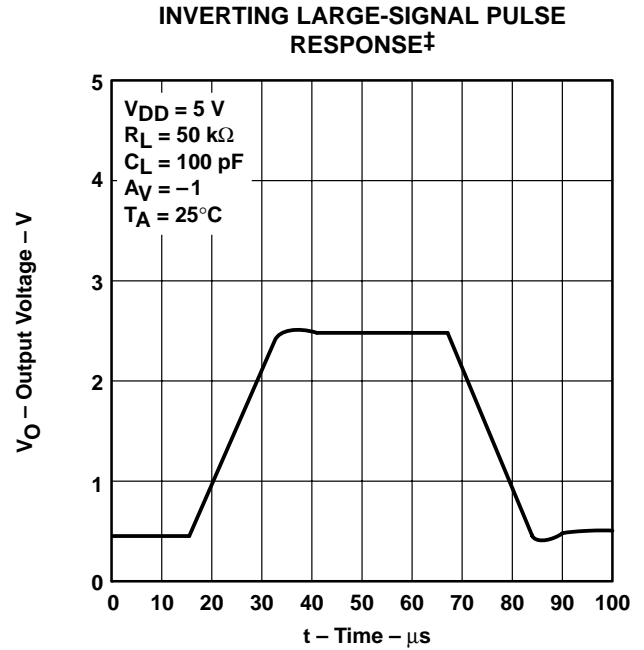
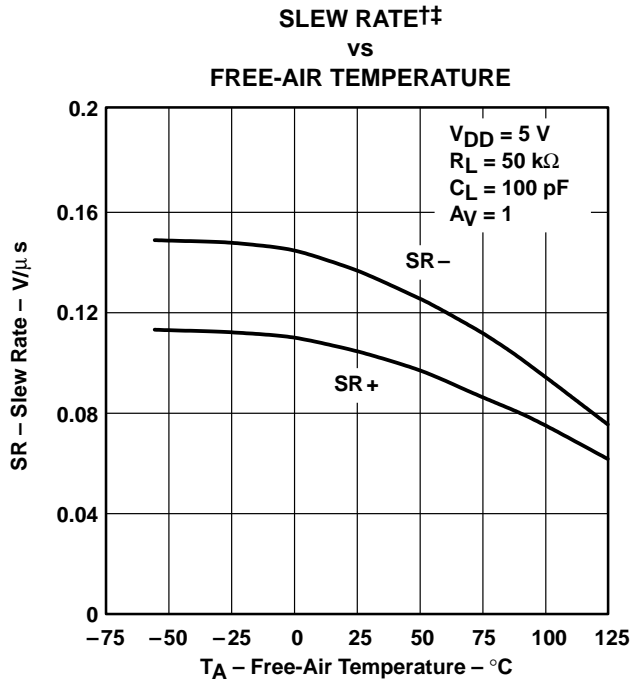

† Data at high and low temperatures are applicable only within the rated operating free-air temperature ranges of the various devices.

‡ For curves where $V_{DD} = 5\text{ V}$, all loads are referenced to 2.5 V.

TYPICAL CHARACTERISTICS

VOLTAGE-FOLLOWER LARGE-SIGNAL PULSE RESPONSE

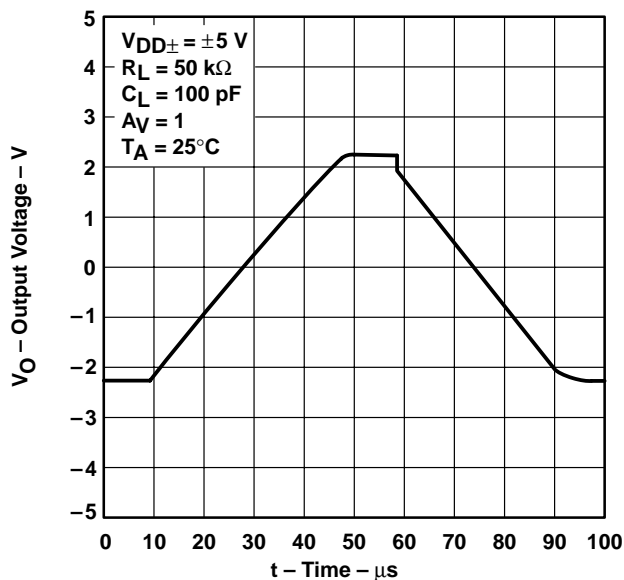

Figure 44

INVERTING SMALL-SIGNAL PULSE RESPONSE†

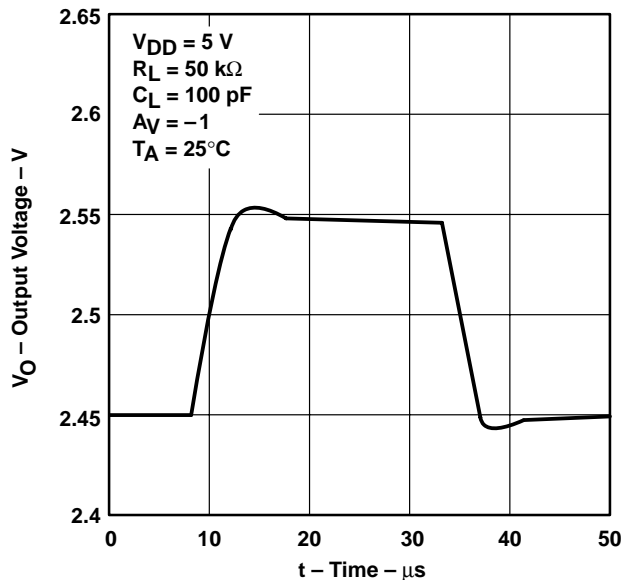

Figure 45

INVERTING SMALL-SIGNAL PULSE RESPONSE

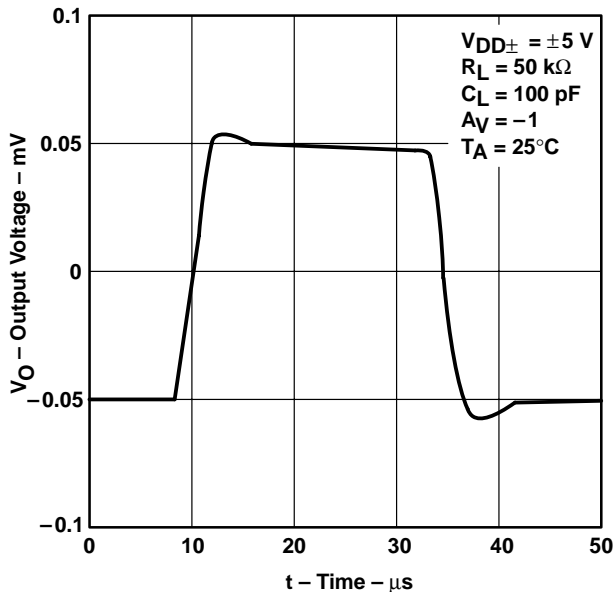

Figure 46

VOLTAGE-FOLLOWER SMALL-SIGNAL PULSE RESPONSE†

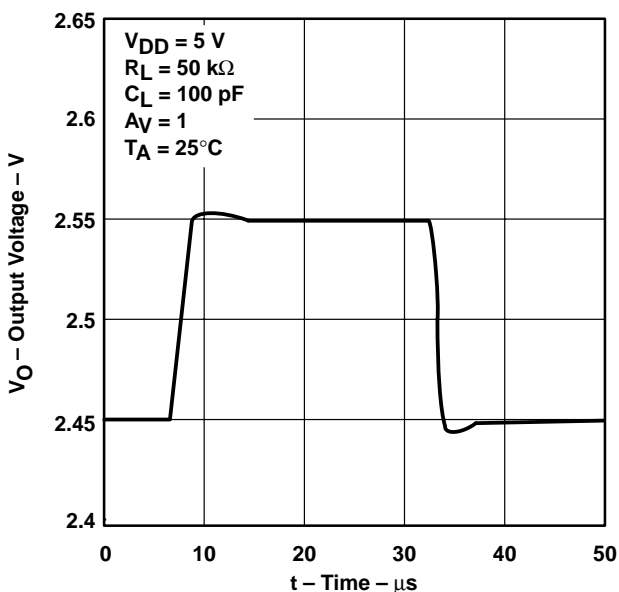

Figure 47

† For curves where $V_{DD} = 5$ V, all loads are referenced to 2.5 V.

TYPICAL CHARACTERISTICS

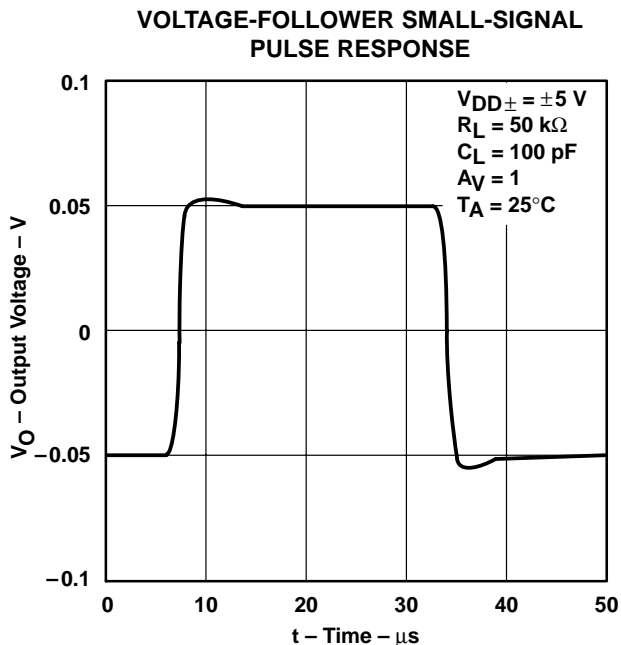

Figure 48

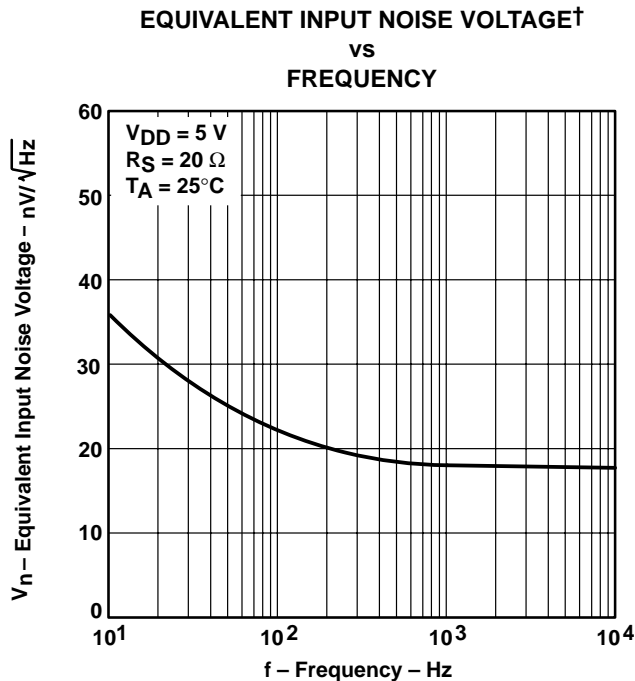

Figure 49

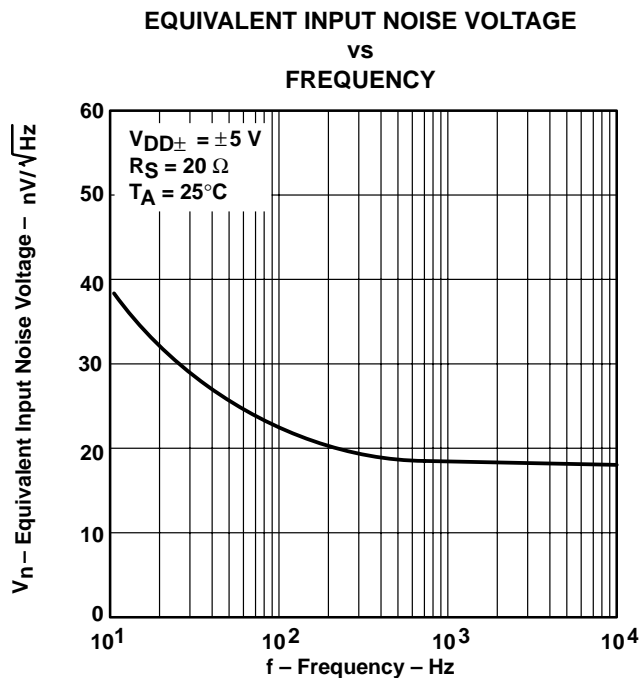

Figure 50

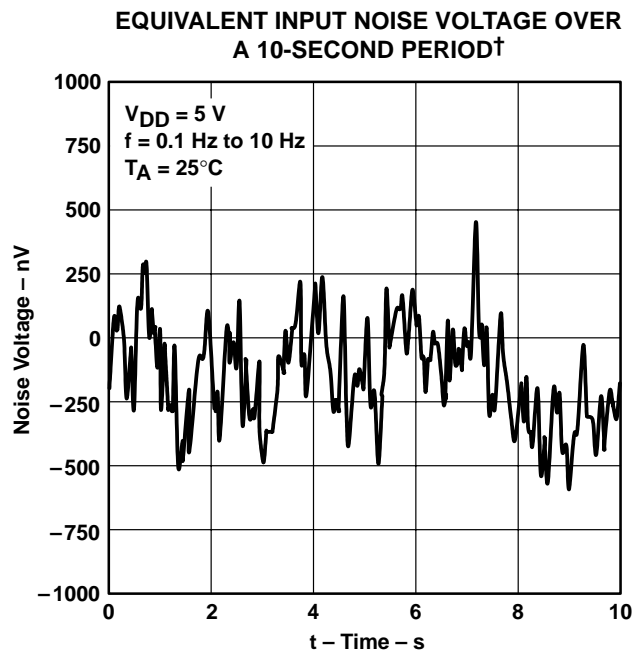

Figure 51

† For curves where $V_{DD} = 5 \text{ V}$, all loads are referenced to 2.5 V.

TYPICAL CHARACTERISTICS

INTEGRATED NOISE VOLTAGE
 VS
 FREQUENCY

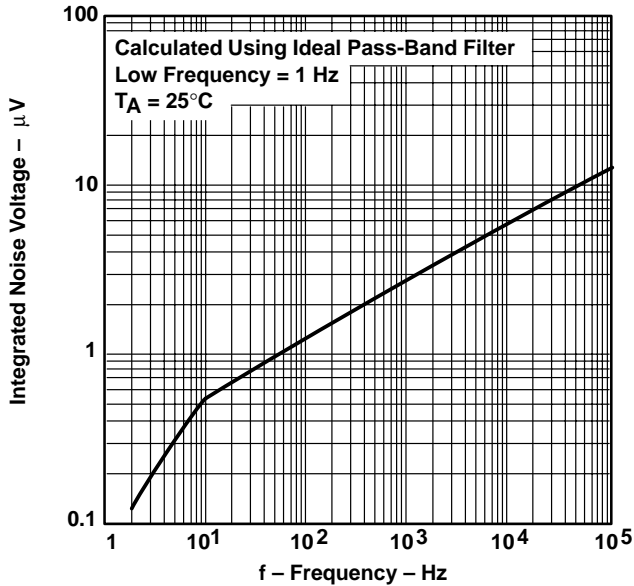

Figure 52

TOTAL HARMONIC DISTORTION PLUS NOISE†
 VS
 FREQUENCY

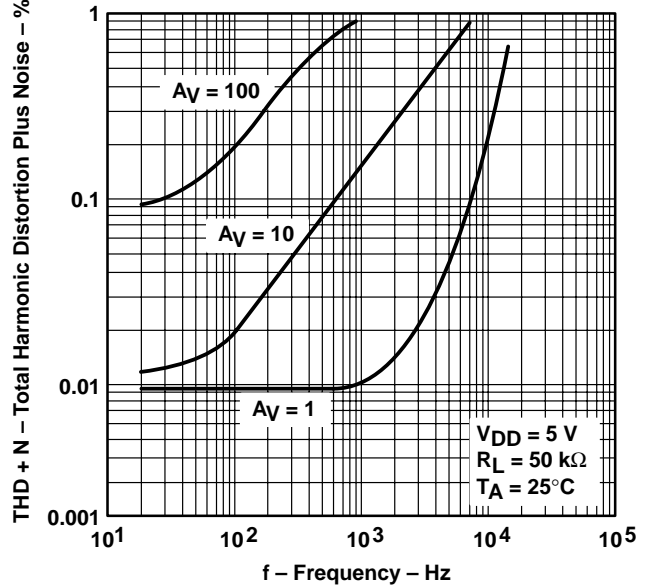

Figure 53

GAIN-BANDWIDTH PRODUCT‡
 VS
 FREE-AIR TEMPERATURE

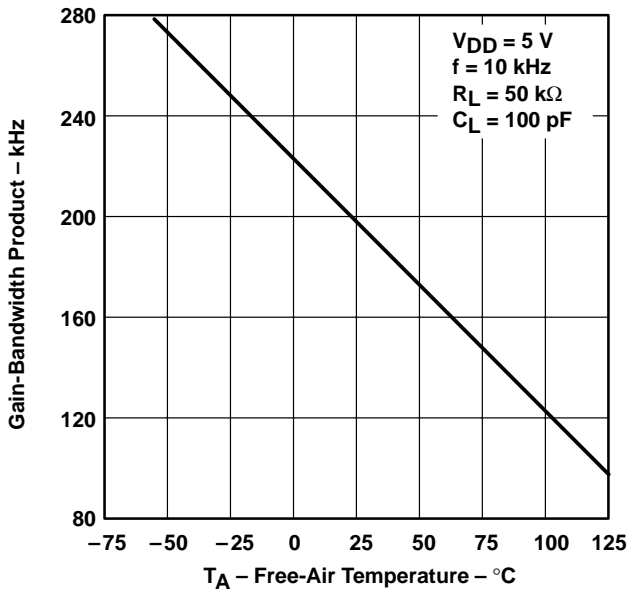

Figure 54

GAIN-BANDWIDTH PRODUCT
 VS
 SUPPLY VOLTAGE

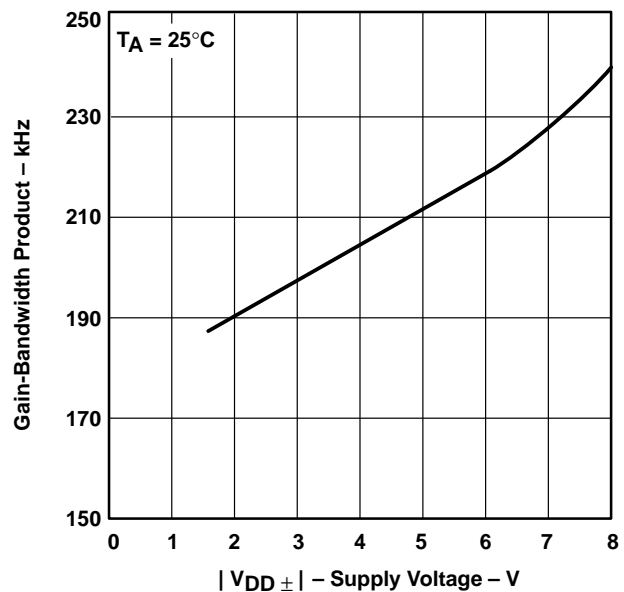

Figure 55

† For curves where $V_{DD} = 5\text{ V}$, all loads are referenced to 2.5 V .

‡ Data at high and low temperatures are applicable only within the rated operating free-air temperature ranges of the various devices.

TYPICAL CHARACTERISTICS

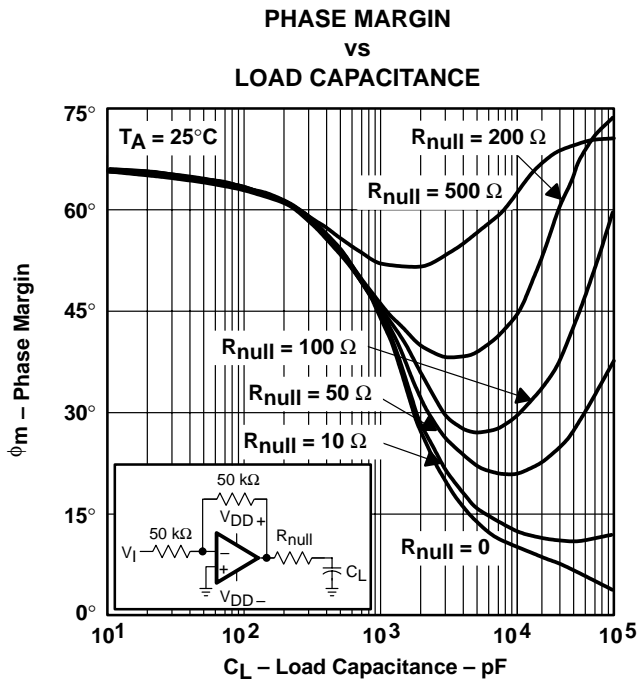

Figure 56

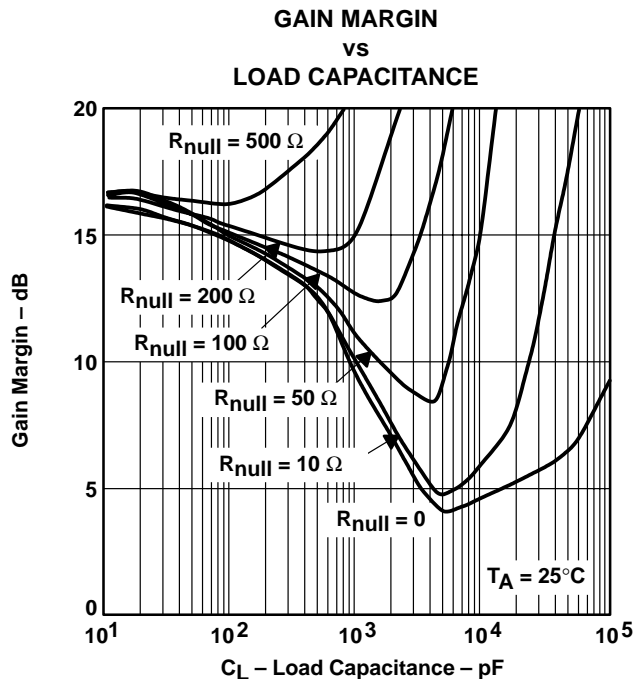

Figure 57

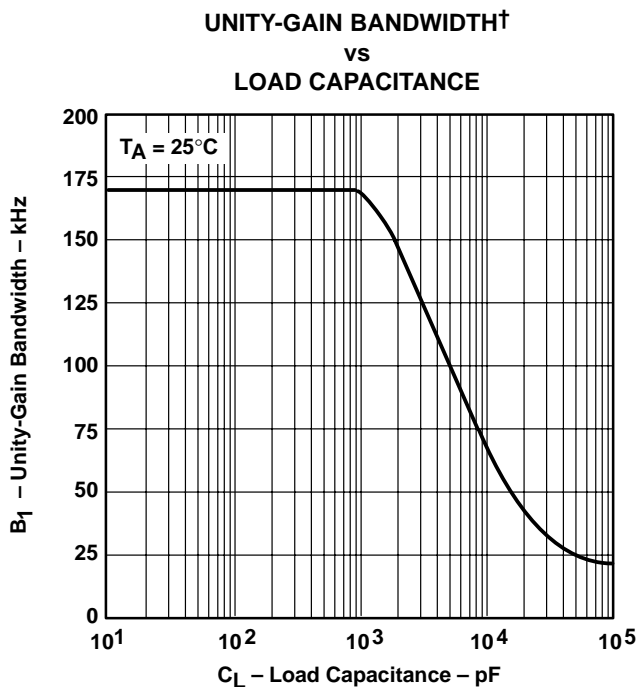

Figure 58

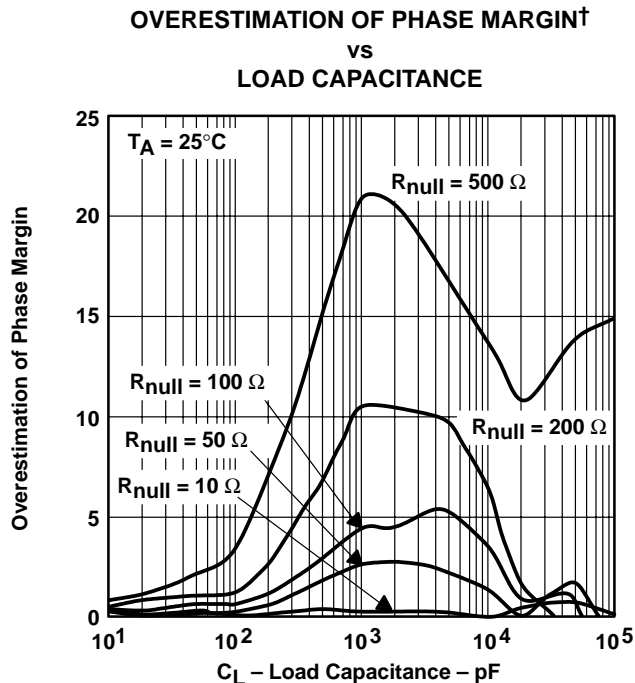

Figure 59

† See application information

APPLICATION INFORMATION

driving large capacitive loads

The TLC225x is designed to drive larger capacitive loads than most CMOS operational amplifiers. Figure 56 and Figure 57 illustrate its ability to drive loads up to 1000 pF while maintaining good gain and phase margins ($R_{null} = 0$).

A smaller series resistor (R_{null}) at the output of the device (see Figure 60) improves the gain and phase margins when driving large capacitive loads. Figure 56 and Figure 57 show the effects of adding series resistances of 10 Ω , 50 Ω , 100 Ω , 200 Ω , and 500 Ω . The addition of this series resistor has two effects: the first is that it adds a zero to the transfer function and the second is that it reduces the frequency of the pole associated with the output load in the transfer function.

The zero introduced to the transfer function is equal to the series resistance times the load capacitance. To calculate the improvement in phase margin, equation 1 can be used.

$$\Delta\phi_{m1} = \tan^{-1} \left(2 \times \pi \times \text{UGBW} \times R_{null} \times C_L \right) \tag{1}$$

Where :

- $\Delta\phi_{m1}$ = Improvement in phase margin
- UGBW = Unity-gain bandwidth frequency
- R_{null} = Output series resistance
- C_L = Load capacitance

The unity-gain bandwidth (UGBW) frequency decreases as the capacitive load increases (see Figure 58). To use equation 1, UGBW must be approximated from Figure 58.

Using equation 1 alone overestimates the improvement in phase margin, as illustrated in Figure 59. The overestimation is caused by the decrease in the frequency of the pole associated with the load, thus providing additional phase shift and reducing the overall improvement in phase margin.

Using Figure 60, with equation 1 enables the designer to choose the appropriate output series resistance to optimize the design of circuits driving large capacitance loads.

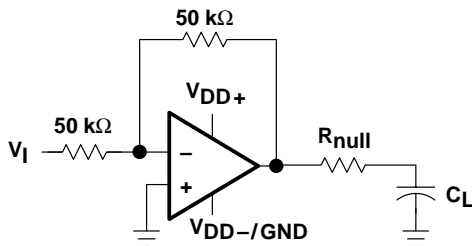

Figure 60. Series-Resistance Circuit

APPLICATION INFORMATION

macromodel information

Macromodel information provided was derived using MicroSim *Parts*™, the model generation software used with MicroSim *PSpice*™. The Boyle macromodel (see Note 5) and subcircuit in Figure 61 are generated using the TLC225x typical electrical and operating characteristics at $T_A = 25^\circ\text{C}$. Using this information, output simulations of the following key parameters can be generated to a tolerance of 20% (in most cases):

- Maximum positive output voltage swing
- Maximum negative output voltage swing
- Slew rate
- Quiescent power dissipation
- Input bias current
- Open-loop voltage amplification
- Unity-gain frequency
- Common-mode rejection ratio
- Phase margin
- DC output resistance
- AC output resistance
- Short-circuit output current limit

NOTE 5: G. R. Boyle, B. M. Cohn, D. O. Pederson, and J. E. Solomon, "Macromodeling of Integrated Circuit Operational Amplifiers", *IEEE Journal of Solid-State Circuits*, SC-9, 353 (1974).

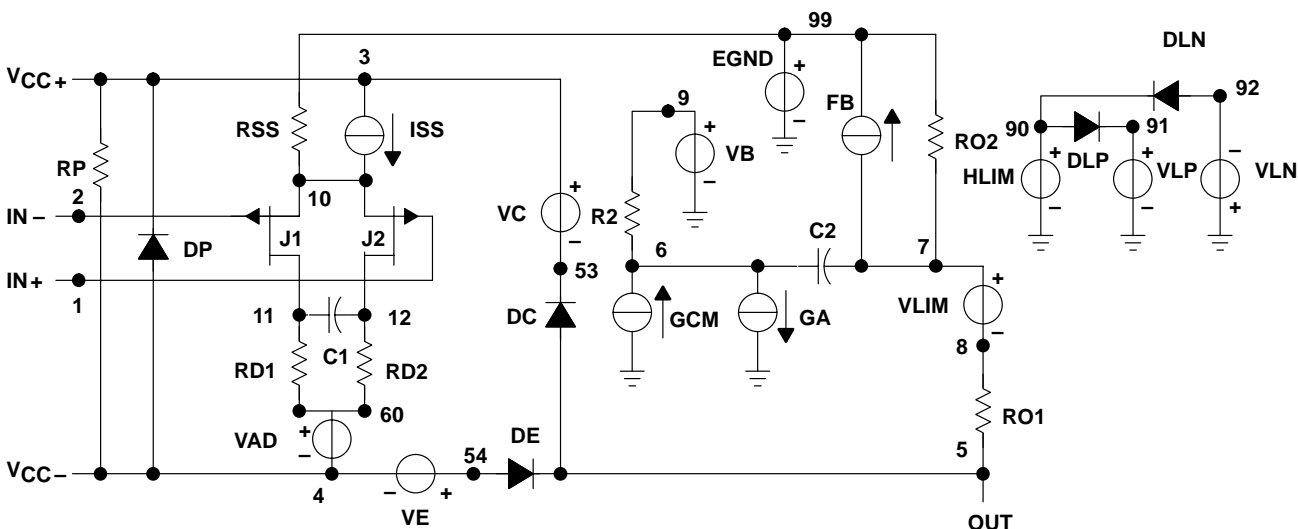

<pre>.SUBCKT TLC225x 1 2 3 4 5 C1 11 12 6.369E-12 C2 6 7 25.00E-12 DC 5 53 DX DE 54 5 DX DLP 90 91 DX DLN 92 90 DX DP 4 3 DX EGND 99 0 POLY (2) (3,0) (4,0) 0 .5 .5 FB 7 99 POLY (5) VB VC VE VLP + VLN 0 57.62E6 -60E6 60E6 60E6 -60E6 GA 6 0 11 12 26.86E-6 GCM 0 6 10 99 2.686E-9 ISS 3 10 DC 3.1E-6 HLIM 90 0 VLIM 1K J1 11 2 10 JX J2 12 1 10 JX R2 6 9 100.0E3</pre>	<pre>RD1 60 11 37.23E3 RD2 60 12 37.23E3 R01 8 5 84 R02 7 99 84 RP 3 4 71.43E3 RSS 10 99 64.52E6 VAD 60 4 -5 VB 9 0 DC 0 VC 3 53 DC .605 VE 54 4 DC .605 VLIM 7 8 DC 0 VLP 91 0 DC -.235 VLN 0 92 DC 7.5 .MODEL DX D (IS=800.0E-18) .MODEL JX PJF (IS=500.0E-15 BETA=139E-6 + VTO=-.05) .ENDS</pre>
---	---

Figure 61. Boyle Macromodel and Subcircuit

PSpice and *Parts* are trademarks of MicroSim Corporation.

PACKAGING INFORMATION

Orderable Device	Status ⁽¹⁾	Package Type	Package Drawing	Pins	Package Qty	Eco Plan ⁽²⁾	Lead/ Ball Finish	MSL Peak Temp ⁽³⁾	Samples (Requires Login)
5962-9564001NXD	ACTIVE	SOIC	D	8	2500	Green (RoHS & no Sb/Br)	CU NIPDAU	Level-1-260C-UNLIM	
5962-9564001NXDR	ACTIVE	SOIC	D	8	2500	Green (RoHS & no Sb/Br)	CU NIPDAU	Level-1-260C-UNLIM	
5962-9564001Q2A	ACTIVE	LCCC	FK	20	1	TBD	Call TI	Call TI	
5962-9564001QHA	ACTIVE	CFP	U	10	1	TBD	Call TI	Call TI	
5962-9564001QPA	ACTIVE	CDIP	JG	8	1	TBD	Call TI	Call TI	
5962-9564002NYDR	ACTIVE	SOIC	D	14	2500	Green (RoHS & no Sb/Br)	CU NIPDAU	Level-1-260C-UNLIM	
5962-9564002Q2A	ACTIVE	LCCC	FK	20	1	TBD	Call TI	Call TI	
5962-9564002QCA	ACTIVE	CDIP	J	14	1	TBD	Call TI	Call TI	
5962-9564002QDA	ACTIVE	CFP	W	14	1	TBD	Call TI	Call TI	
5962-9564003NXD	ACTIVE	SOIC	D	8	2500	Green (RoHS & no Sb/Br)	CU NIPDAU	Level-1-260C-UNLIM	
5962-9564003NXDR	ACTIVE	SOIC	D	8	2500	Green (RoHS & no Sb/Br)	CU NIPDAU	Level-1-260C-UNLIM	
5962-9564003Q2A	ACTIVE	LCCC	FK	20	1	TBD	Call TI	Call TI	
5962-9564003QHA	ACTIVE	CFP	U	10	1	TBD	Call TI	Call TI	
5962-9564003QPA	ACTIVE	CDIP	JG	8	1	TBD	Call TI	Call TI	
5962-9564004NYDR	ACTIVE	SOIC	D	14	2500	Green (RoHS & no Sb/Br)	CU NIPDAU	Level-1-260C-UNLIM	
5962-9564004Q2A	ACTIVE	LCCC	FK	20	1	TBD	Call TI	Call TI	
5962-9564004QCA	ACTIVE	CDIP	J	14	1	TBD	Call TI	Call TI	
5962-9564004QDA	ACTIVE	CFP	W	14	1	TBD	Call TI	Call TI	
TLC2252AID	ACTIVE	SOIC	D	8	75	Green (RoHS & no Sb/Br)	CU NIPDAU	Level-1-260C-UNLIM	
TLC2252AIDG4	ACTIVE	SOIC	D	8	75	Green (RoHS & no Sb/Br)	CU NIPDAU	Level-1-260C-UNLIM	
TLC2252AIDR	ACTIVE	SOIC	D	8	2500	Green (RoHS & no Sb/Br)	CU NIPDAU	Level-1-260C-UNLIM	
TLC2252AIDRG4	ACTIVE	SOIC	D	8	2500	Green (RoHS & no Sb/Br)	CU NIPDAU	Level-1-260C-UNLIM	

Orderable Device	Status ⁽¹⁾	Package Type	Package Drawing	Pins	Package Qty	Eco Plan ⁽²⁾	Lead/ Ball Finish	MSL Peak Temp ⁽³⁾	Samples (Requires Login)
TLC2252AIP	ACTIVE	PDIP	P	8	50	Pb-Free (RoHS)	CU NIPDAU	N / A for Pkg Type	
TLC2252AIP4E4	ACTIVE	PDIP	P	8	50	Pb-Free (RoHS)	CU NIPDAU	N / A for Pkg Type	
TLC2252AIPW	ACTIVE	TSSOP	PW	8	150	Green (RoHS & no Sb/Br)	CU NIPDAU	Level-1-260C-UNLIM	
TLC2252AIPWG4	ACTIVE	TSSOP	PW	8	150	Green (RoHS & no Sb/Br)	CU NIPDAU	Level-1-260C-UNLIM	
TLC2252AIPWLE	OBSOLETE	TSSOP	PW	8		TBD	Call TI	Call TI	
TLC2252AIPWR	ACTIVE	TSSOP	PW	8	2000	Green (RoHS & no Sb/Br)	CU NIPDAU	Level-1-260C-UNLIM	
TLC2252AIPWRG4	ACTIVE	TSSOP	PW	8	2000	Green (RoHS & no Sb/Br)	CU NIPDAU	Level-1-260C-UNLIM	
TLC2252AMFKB	ACTIVE	LCCC	FK	20	1	TBD	POST-PLATE	N / A for Pkg Type	
TLC2252AMJGB	ACTIVE	CDIP	JG	8	1	TBD	A42	N / A for Pkg Type	
TLC2252AMUB	ACTIVE	CFP	U	10	1	TBD	A42	N / A for Pkg Type	
TLC2252AQD	ACTIVE	SOIC	D	8	75	Green (RoHS & no Sb/Br)	CU NIPDAU	Level-1-260C-UNLIM	
TLC2252AQDG4	ACTIVE	SOIC	D	8	75	Green (RoHS & no Sb/Br)	CU NIPDAU	Level-1-260C-UNLIM	
TLC2252AQDR	ACTIVE	SOIC	D	8	2500	Green (RoHS & no Sb/Br)	CU NIPDAU	Level-1-260C-UNLIM	
TLC2252AQDRG4	ACTIVE	SOIC	D	8	2500	Green (RoHS & no Sb/Br)	CU NIPDAU	Level-1-260C-UNLIM	
TLC2252CD	ACTIVE	SOIC	D	8	75	Green (RoHS & no Sb/Br)	CU NIPDAU	Level-1-260C-UNLIM	
TLC2252CDG4	ACTIVE	SOIC	D	8	75	Green (RoHS & no Sb/Br)	CU NIPDAU	Level-1-260C-UNLIM	
TLC2252CDR	ACTIVE	SOIC	D	8	2500	Green (RoHS & no Sb/Br)	CU NIPDAU	Level-1-260C-UNLIM	
TLC2252CDRG4	ACTIVE	SOIC	D	8	2500	Green (RoHS & no Sb/Br)	CU NIPDAU	Level-1-260C-UNLIM	
TLC2252CP	ACTIVE	PDIP	P	8	50	Pb-Free (RoHS)	CU NIPDAU	N / A for Pkg Type	
TLC2252CPE4	ACTIVE	PDIP	P	8	50	Pb-Free (RoHS)	CU NIPDAU	N / A for Pkg Type	
TLC2252CPW	ACTIVE	TSSOP	PW	8	150	Green (RoHS & no Sb/Br)	CU NIPDAU	Level-1-260C-UNLIM	

Orderable Device	Status ⁽¹⁾	Package Type	Package Drawing	Pins	Package Qty	Eco Plan ⁽²⁾	Lead/ Ball Finish	MSL Peak Temp ⁽³⁾	Samples (Requires Login)
TLC2252CPWG4	ACTIVE	TSSOP	PW	8	150	Green (RoHS & no Sb/Br)	CU NIPDAU	Level-1-260C-UNLIM	
TLC2252CPWLE	OBSOLETE	TSSOP	PW	8		TBD	Call TI	Call TI	
TLC2252CPWR	ACTIVE	TSSOP	PW	8	2000	Green (RoHS & no Sb/Br)	CU NIPDAU	Level-1-260C-UNLIM	
TLC2252CPWRG4	ACTIVE	TSSOP	PW	8	2000	Green (RoHS & no Sb/Br)	CU NIPDAU	Level-1-260C-UNLIM	
TLC2252ID	ACTIVE	SOIC	D	8	75	Green (RoHS & no Sb/Br)	CU NIPDAU	Level-1-260C-UNLIM	
TLC2252IDG4	ACTIVE	SOIC	D	8	75	Green (RoHS & no Sb/Br)	CU NIPDAU	Level-1-260C-UNLIM	
TLC2252IDR	ACTIVE	SOIC	D	8	2500	Green (RoHS & no Sb/Br)	CU NIPDAU	Level-1-260C-UNLIM	
TLC2252IDRG4	ACTIVE	SOIC	D	8	2500	Green (RoHS & no Sb/Br)	CU NIPDAU	Level-1-260C-UNLIM	
TLC2252IP	ACTIVE	PDIP	P	8	50	Pb-Free (RoHS)	CU NIPDAU	N / A for Pkg Type	
TLC2252IPE4	ACTIVE	PDIP	P	8	50	Pb-Free (RoHS)	CU NIPDAU	N / A for Pkg Type	
TLC2252MFKB	ACTIVE	LCCC	FK	20	1	TBD	POST-PLATE	N / A for Pkg Type	
TLC2252MJGB	ACTIVE	CDIP	JG	8	1	TBD	A42	N / A for Pkg Type	
TLC2252MUB	ACTIVE	CFP	U	10	1	TBD	A42	N / A for Pkg Type	
TLC2252QD	ACTIVE	SOIC	D	8	75	Green (RoHS & no Sb/Br)	CU NIPDAU	Level-1-260C-UNLIM	
TLC2252QDG4	ACTIVE	SOIC	D	8	75	Green (RoHS & no Sb/Br)	CU NIPDAU	Level-1-260C-UNLIM	
TLC2252QDR	ACTIVE	SOIC	D	8	2500	Green (RoHS & no Sb/Br)	CU NIPDAU	Level-1-260C-UNLIM	
TLC2252QDRG4	ACTIVE	SOIC	D	8	2500	Green (RoHS & no Sb/Br)	CU NIPDAU	Level-1-260C-UNLIM	
TLC2254AID	ACTIVE	SOIC	D	14	50	Green (RoHS & no Sb/Br)	CU NIPDAU	Level-1-260C-UNLIM	
TLC2254AIDG4	ACTIVE	SOIC	D	14	50	Green (RoHS & no Sb/Br)	CU NIPDAU	Level-1-260C-UNLIM	
TLC2254AIDR	ACTIVE	SOIC	D	14	2500	Green (RoHS & no Sb/Br)	CU NIPDAU	Level-1-260C-UNLIM	

Orderable Device	Status ⁽¹⁾	Package Type	Package Drawing	Pins	Package Qty	Eco Plan ⁽²⁾	Lead/ Ball Finish	MSL Peak Temp ⁽³⁾	Samples (Requires Login)
TLC2254AIDRG4	ACTIVE	SOIC	D	14	2500	Green (RoHS & no Sb/Br)	CU NIPDAU	Level-1-260C-UNLIM	
TLC2254AIN	ACTIVE	PDIP	N	14	25	Pb-Free (RoHS)	CU NIPDAU	N / A for Pkg Type	
TLC2254AINE4	ACTIVE	PDIP	N	14	25	Pb-Free (RoHS)	CU NIPDAU	N / A for Pkg Type	
TLC2254AIPW	ACTIVE	TSSOP	PW	14	90	Green (RoHS & no Sb/Br)	CU NIPDAU	Level-1-260C-UNLIM	
TLC2254AIPWG4	ACTIVE	TSSOP	PW	14	90	Green (RoHS & no Sb/Br)	CU NIPDAU	Level-1-260C-UNLIM	
TLC2254AIPWLE	OBSOLETE	TSSOP	PW	14		TBD	Call TI	Call TI	
TLC2254AIPWR	ACTIVE	TSSOP	PW	14	2000	Green (RoHS & no Sb/Br)	CU NIPDAU	Level-1-260C-UNLIM	
TLC2254AIPWRG4	ACTIVE	TSSOP	PW	14	2000	Green (RoHS & no Sb/Br)	CU NIPDAU	Level-1-260C-UNLIM	
TLC2254AMFKB	ACTIVE	LCCC	FK	20	1	TBD	POST-PLATE	N / A for Pkg Type	
TLC2254AMJB	ACTIVE	CDIP	J	14	1	TBD	A42	N / A for Pkg Type	
TLC2254AMWB	ACTIVE	CFP	W	14	1	TBD	A42	N / A for Pkg Type	
TLC2254AQD	ACTIVE	SOIC	D	14	50	TBD	CU NIPDAU	Level-1-220C-UNLIM	
TLC2254AQDG4	ACTIVE	SOIC	D	14	50	Green (RoHS & no Sb/Br)	CU NIPDAU	Level-1-260C-UNLIM	
TLC2254AQDR	ACTIVE	SOIC	D	14	2500	TBD	CU NIPDAU	Level-1-220C-UNLIM	
TLC2254AQDRG4	ACTIVE	SOIC	D	14	2500	Green (RoHS & no Sb/Br)	CU NIPDAU	Level-1-260C-UNLIM	
TLC2254CD	ACTIVE	SOIC	D	14	50	Green (RoHS & no Sb/Br)	Call TI	Level-1-260C-UNLIM	
TLC2254CDG4	ACTIVE	SOIC	D	14	50	Green (RoHS & no Sb/Br)	Call TI	Level-1-260C-UNLIM	
TLC2254CDR	ACTIVE	SOIC	D	14	2500	Green (RoHS & no Sb/Br)	Call TI	Level-1-260C-UNLIM	
TLC2254CDRG4	ACTIVE	SOIC	D	14	2500	Green (RoHS & no Sb/Br)	Call TI	Level-1-260C-UNLIM	
TLC2254CN	ACTIVE	PDIP	N	14	25	Pb-Free (RoHS)	CU NIPDAU	N / A for Pkg Type	
TLC2254CNE4	ACTIVE	PDIP	N	14	25	Pb-Free (RoHS)	CU NIPDAU	N / A for Pkg Type	
TLC2254CPW	ACTIVE	TSSOP	PW	14	90	Green (RoHS & no Sb/Br)	CU NIPDAU	Level-1-260C-UNLIM	

Orderable Device	Status ⁽¹⁾	Package Type	Package Drawing	Pins	Package Qty	Eco Plan ⁽²⁾	Lead/ Ball Finish	MSL Peak Temp ⁽³⁾	Samples (Requires Login)
TLC2254CPWG4	ACTIVE	TSSOP	PW	14	90	Green (RoHS & no Sb/Br)	CU NIPDAU	Level-1-260C-UNLIM	
TLC2254CPWLE	OBSOLETE	TSSOP	PW	14		TBD	Call TI	Call TI	
TLC2254CPWR	ACTIVE	TSSOP	PW	14	2000	Green (RoHS & no Sb/Br)	CU NIPDAU	Level-1-260C-UNLIM	
TLC2254CPWRG4	ACTIVE	TSSOP	PW	14	2000	Green (RoHS & no Sb/Br)	CU NIPDAU	Level-1-260C-UNLIM	
TLC2254ID	ACTIVE	SOIC	D	14	50	Green (RoHS & no Sb/Br)	CU NIPDAU	Level-1-260C-UNLIM	
TLC2254IDG4	ACTIVE	SOIC	D	14	50	Green (RoHS & no Sb/Br)	CU NIPDAU	Level-1-260C-UNLIM	
TLC2254IDR	ACTIVE	SOIC	D	14	2500	Green (RoHS & no Sb/Br)	CU NIPDAU	Level-1-260C-UNLIM	
TLC2254IDRG4	ACTIVE	SOIC	D	14	2500	Green (RoHS & no Sb/Br)	CU NIPDAU	Level-1-260C-UNLIM	
TLC2254IN	ACTIVE	PDIP	N	14	25	Pb-Free (RoHS)	CU NIPDAU	N / A for Pkg Type	
TLC2254INE4	ACTIVE	PDIP	N	14	25	Pb-Free (RoHS)	CU NIPDAU	N / A for Pkg Type	
TLC2254MFKB	ACTIVE	LCCC	FK	20	1	TBD	POST-PLATE	N / A for Pkg Type	
TLC2254MJB	ACTIVE	CDIP	J	14	1	TBD	A42	N / A for Pkg Type	
TLC2254MWB	ACTIVE	CFP	W	14	1	TBD	A42	N / A for Pkg Type	
TLC2254QD	ACTIVE	SOIC	D	14	50	TBD	CU NIPDAU	Level-1-220C-UNLIM	
TLC2254QDG4	ACTIVE	SOIC	D	14	50	Green (RoHS & no Sb/Br)	CU NIPDAU	Level-1-260C-UNLIM	
TLC2254QDR	ACTIVE	SOIC	D	14	2500	TBD	CU NIPDAU	Level-1-220C-UNLIM	
TLC2254QDRG4	ACTIVE	SOIC	D	14	2500	Green (RoHS & no Sb/Br)	CU NIPDAU	Level-1-260C-UNLIM	

⁽¹⁾ The marketing status values are defined as follows:

ACTIVE: Product device recommended for new designs.

LIFEBUY: TI has announced that the device will be discontinued, and a lifetime-buy period is in effect.

NRND: Not recommended for new designs. Device is in production to support existing customers, but TI does not recommend using this part in a new design.

PREVIEW: Device has been announced but is not in production. Samples may or may not be available.

OBSOLETE: TI has discontinued the production of the device.

⁽²⁾ Eco Plan - The planned eco-friendly classification: Pb-Free (RoHS), Pb-Free (RoHS Exempt), or Green (RoHS & no Sb/Br) - please check <http://www.ti.com/productcontent> for the latest availability information and additional product content details.

TBD: The Pb-Free/Green conversion plan has not been defined.

Pb-Free (RoHS): TI's terms "Lead-Free" or "Pb-Free" mean semiconductor products that are compatible with the current RoHS requirements for all 6 substances, including the requirement that lead not exceed 0.1% by weight in homogeneous materials. Where designed to be soldered at high temperatures, TI Pb-Free products are suitable for use in specified lead-free processes.

Pb-Free (RoHS Exempt): This component has a RoHS exemption for either 1) lead-based flip-chip solder bumps used between the die and package, or 2) lead-based die adhesive used between the die and leadframe. The component is otherwise considered Pb-Free (RoHS compatible) as defined above.

Green (RoHS & no Sb/Br): TI defines "Green" to mean Pb-Free (RoHS compatible), and free of Bromine (Br) and Antimony (Sb) based flame retardants (Br or Sb do not exceed 0.1% by weight in homogeneous material)

⁽³⁾ MSL, Peak Temp. -- The Moisture Sensitivity Level rating according to the JEDEC industry standard classifications, and peak solder temperature.

Important Information and Disclaimer:The information provided on this page represents TI's knowledge and belief as of the date that it is provided. TI bases its knowledge and belief on information provided by third parties, and makes no representation or warranty as to the accuracy of such information. Efforts are underway to better integrate information from third parties. TI has taken and continues to take reasonable steps to provide representative and accurate information but may not have conducted destructive testing or chemical analysis on incoming materials and chemicals. TI and TI suppliers consider certain information to be proprietary, and thus CAS numbers and other limited information may not be available for release.

In no event shall TI's liability arising out of such information exceed the total purchase price of the TI part(s) at issue in this document sold by TI to Customer on an annual basis.

OTHER QUALIFIED VERSIONS OF TLC2252, TLC2252A, TLC2252AM, TLC2252M, TLC2254, TLC2254A, TLC2254AM, TLC2254M :

- Catalog: [TLC2252A](#), [TLC2252](#), [TLC2254A](#), [TLC2254](#)
- Automotive: [TLC2252-Q1](#), [TLC2252A-Q1](#), [TLC2252A-Q1](#), [TLC2252-Q1](#), [TLC2254-Q1](#), [TLC2254A-Q1](#), [TLC2254A-Q1](#), [TLC2254-Q1](#)
- Enhanced Product: [TLC2252-EP](#), [TLC2252A-EP](#), [TLC2252A-EP](#), [TLC2252-EP](#), [TLC2254-EP](#), [TLC2254A-EP](#), [TLC2254A-EP](#), [TLC2254-EP](#)
- Military: [TLC2252M](#), [TLC2252AM](#), [TLC2254M](#), [TLC2254AM](#)

NOTE: Qualified Version Definitions:

- Catalog - TI's standard catalog product
- Automotive - Q100 devices qualified for high-reliability automotive applications targeting zero defects
- Enhanced Product - Supports Defense, Aerospace and Medical Applications
- Military - QML certified for Military and Defense Applications

TAPE AND REEL INFORMATION

QUADRANT ASSIGNMENTS FOR PIN 1 ORIENTATION IN TAPE

*All dimensions are nominal

Device	Package Type	Package Drawing	Pins	SPQ	Reel Diameter (mm)	Reel Width W1 (mm)	A0 (mm)	B0 (mm)	K0 (mm)	P1 (mm)	W (mm)	Pin1 Quadrant
5962-9564001NXDR	SOIC	D	8	2500	330.0	12.4	6.4	5.2	2.1	8.0	12.0	Q1
5962-9564002NYDR	SOIC	D	14	2500	330.0	16.4	6.5	9.0	2.1	8.0	16.0	Q1
5962-9564003NXDR	SOIC	D	8	2500	330.0	12.4	6.4	5.2	2.1	8.0	12.0	Q1
5962-9564004NYDR	SOIC	D	14	2500	330.0	16.4	6.5	9.0	2.1	8.0	16.0	Q1
TLC2252AIDR	SOIC	D	8	2500	330.0	12.4	6.4	5.2	2.1	8.0	12.0	Q1
TLC2252AIPWR	TSSOP	PW	8	2000	330.0	12.4	7.0	3.6	1.6	8.0	12.0	Q1
TLC2252CDR	SOIC	D	8	2500	330.0	12.4	6.4	5.2	2.1	8.0	12.0	Q1
TLC2252CPWR	TSSOP	PW	8	2000	330.0	12.4	7.0	3.6	1.6	8.0	12.0	Q1
TLC2252IDR	SOIC	D	8	2500	330.0	12.4	6.4	5.2	2.1	8.0	12.0	Q1
TLC2254AIDR	SOIC	D	14	2500	330.0	16.4	6.5	9.0	2.1	8.0	16.0	Q1
TLC2254AIPWR	TSSOP	PW	14	2000	330.0	12.4	6.9	5.6	1.6	8.0	12.0	Q1
TLC2254AQDR	SOIC	D	14	2500	330.0	16.4	6.5	9.0	2.1	8.0	16.0	Q1
TLC2254CDR	SOIC	D	14	2500	330.0	16.4	6.5	9.0	2.1	8.0	16.0	Q1
TLC2254CPWR	TSSOP	PW	14	2000	330.0	12.4	6.9	5.6	1.6	8.0	12.0	Q1
TLC2254IDR	SOIC	D	14	2500	330.0	16.4	6.5	9.0	2.1	8.0	16.0	Q1
TLC2254QDR	SOIC	D	14	2500	330.0	16.4	6.5	9.0	2.1	8.0	16.0	Q1

TAPE AND REEL BOX DIMENSIONS

*All dimensions are nominal

Device	Package Type	Package Drawing	Pins	SPQ	Length (mm)	Width (mm)	Height (mm)
5962-9564001NXDR	SOIC	D	8	2500	346.0	346.0	29.0
5962-9564002NYDR	SOIC	D	14	2500	346.0	346.0	33.0
5962-9564003NXDR	SOIC	D	8	2500	346.0	346.0	29.0
5962-9564004NYDR	SOIC	D	14	2500	346.0	346.0	33.0
TLC2252AIDR	SOIC	D	8	2500	340.5	338.1	20.6
TLC2252AIPWR	TSSOP	PW	8	2000	346.0	346.0	29.0
TLC2252CDR	SOIC	D	8	2500	340.5	338.1	20.6
TLC2252CPWR	TSSOP	PW	8	2000	346.0	346.0	29.0
TLC2252IDR	SOIC	D	8	2500	340.5	338.1	20.6
TLC2254AIDR	SOIC	D	14	2500	346.0	346.0	33.0
TLC2254AIPWR	TSSOP	PW	14	2000	346.0	346.0	29.0
TLC2254AQDR	SOIC	D	14	2500	346.0	346.0	33.0
TLC2254CDR	SOIC	D	14	2500	346.0	346.0	33.0
TLC2254CPWR	TSSOP	PW	14	2000	346.0	346.0	29.0
TLC2254IDR	SOIC	D	14	2500	346.0	346.0	33.0
TLC2254QDR	SOIC	D	14	2500	346.0	346.0	33.0

JG (R-GDIP-T8)

CERAMIC DUAL-IN-LINE

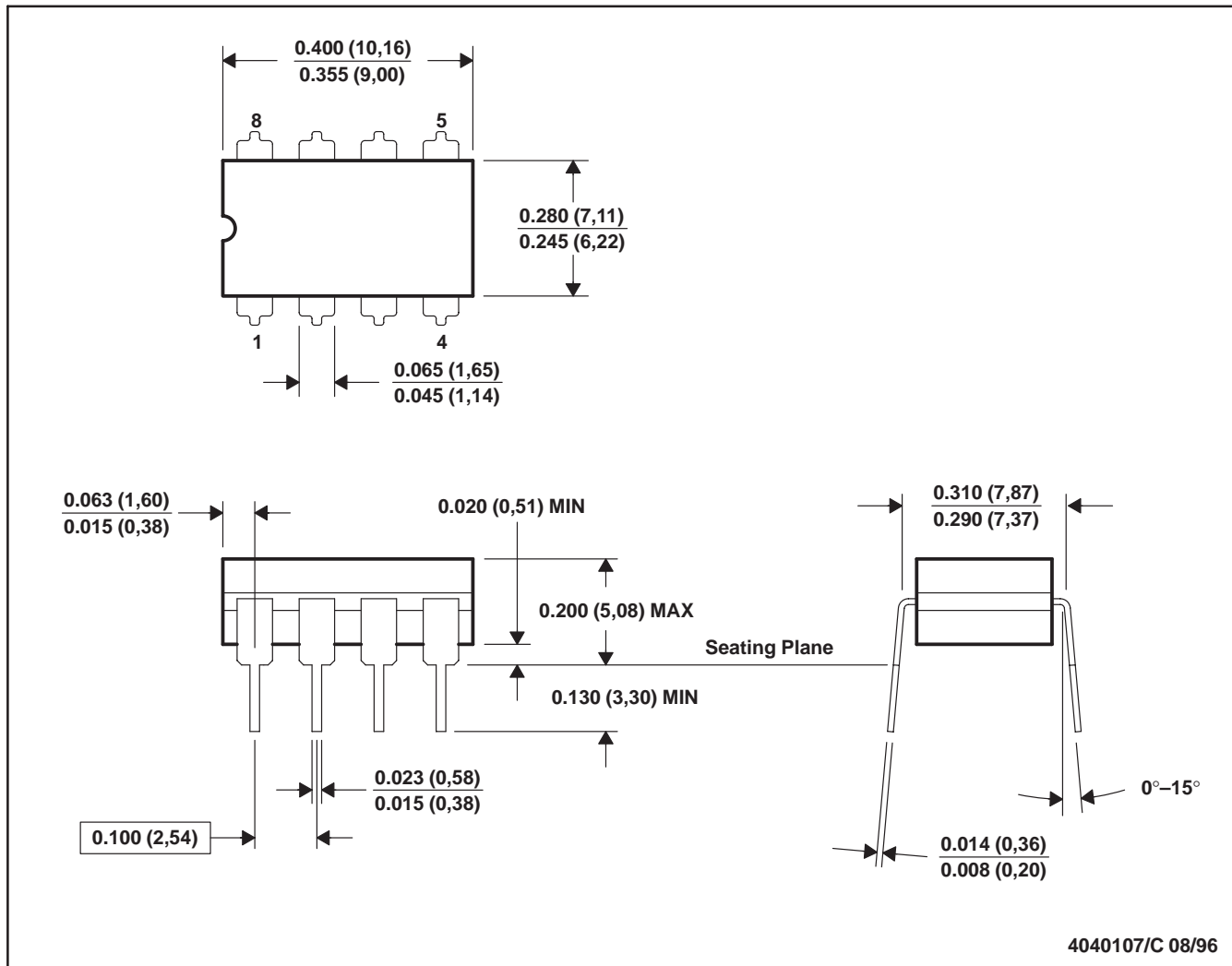

- NOTES: A. All linear dimensions are in inches (millimeters).
 B. This drawing is subject to change without notice.
 C. This package can be hermetically sealed with a ceramic lid using glass frit.
 D. Index point is provided on cap for terminal identification.
 E. Falls within MIL STD 1835 GDIP1-T8

J (R-GDIP-T**)
14 LEADS SHOWN

CERAMIC DUAL IN-LINE PACKAGE

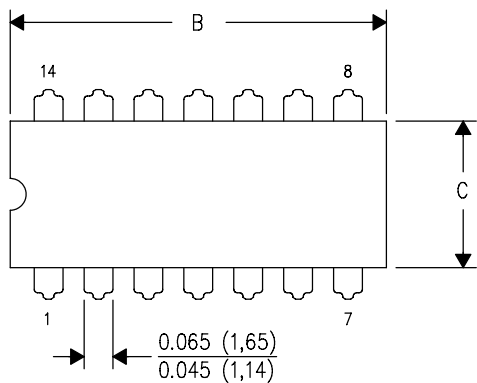

DIM \ PINS **	14	16	18	20
A	0.300 (7,62) BSC	0.300 (7,62) BSC	0.300 (7,62) BSC	0.300 (7,62) BSC
B MAX	0.785 (19,94)	.840 (21,34)	0.960 (24,38)	1.060 (26,92)
B MIN	—	—	—	—
C MAX	0.300 (7,62)	0.300 (7,62)	0.310 (7,87)	0.300 (7,62)
C MIN	0.245 (6,22)	0.245 (6,22)	0.220 (5,59)	0.245 (6,22)

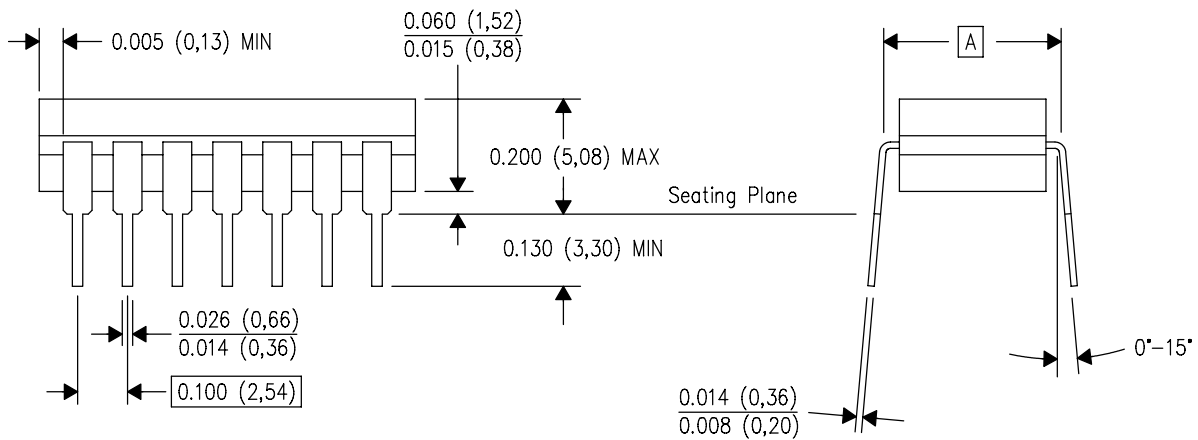

4040083/F 03/03

- NOTES:
- All linear dimensions are in inches (millimeters).
 - This drawing is subject to change without notice.
 - This package is hermetically sealed with a ceramic lid using glass frit.
 - Index point is provided on cap for terminal identification only on press ceramic glass frit seal only.
 - Falls within MIL STD 1835 GDIP1-T14, GDIP1-T16, GDIP1-T18 and GDIP1-T20.

U (S-GDFP-F10)

CERAMIC DUAL FLATPACK

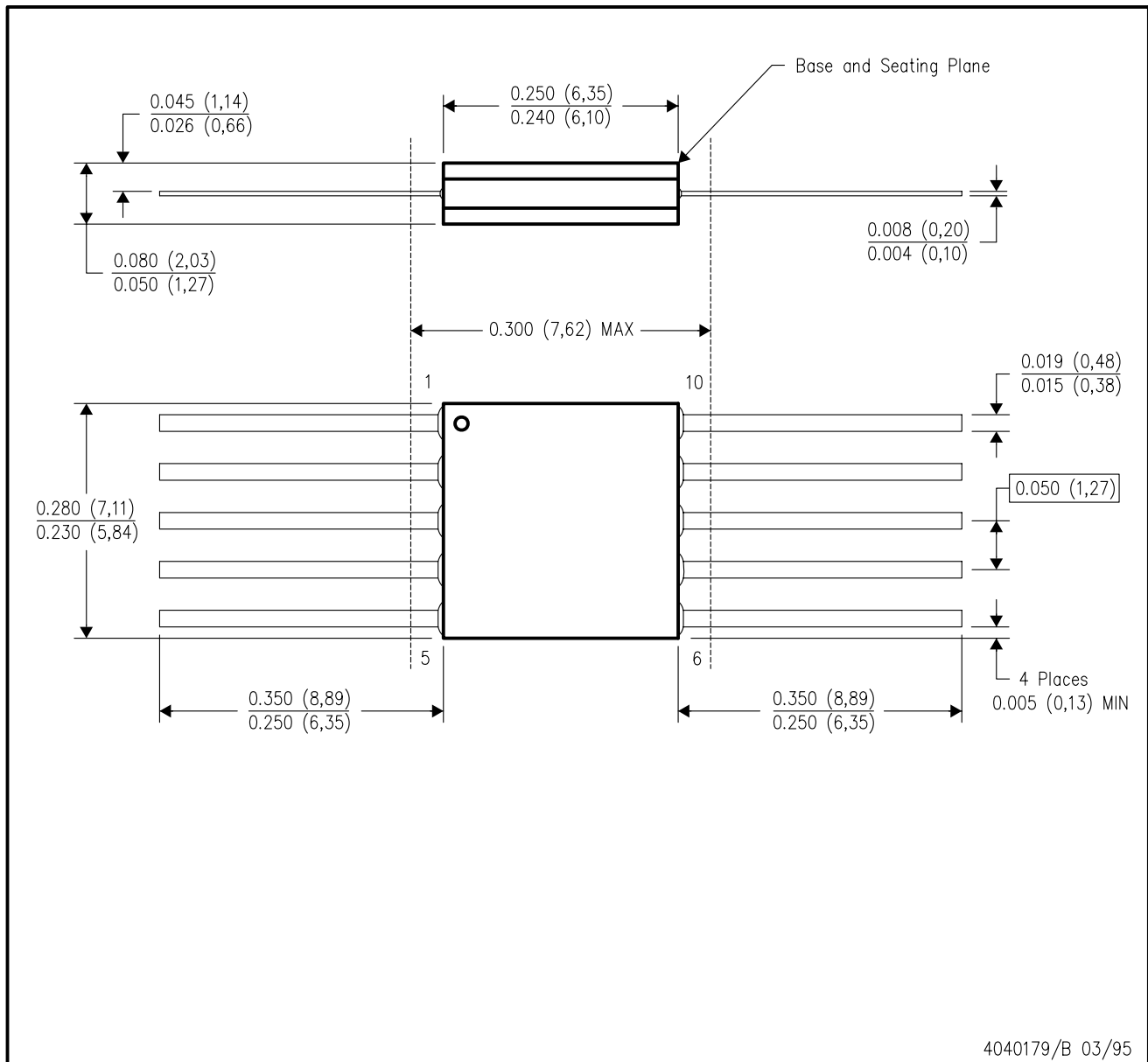

- NOTES:
- A. All linear dimensions are in inches (millimeters).
 - B. This drawing is subject to change without notice.
 - C. This package can be hermetically sealed with a ceramic lid using glass frit.
 - D. Index point is provided on cap for terminal identification only.
 - E. Falls within MIL STD 1835 GDFP1-F10 and JEDEC MO-092AA

W (R-GDFP-F14)

CERAMIC DUAL FLATPACK

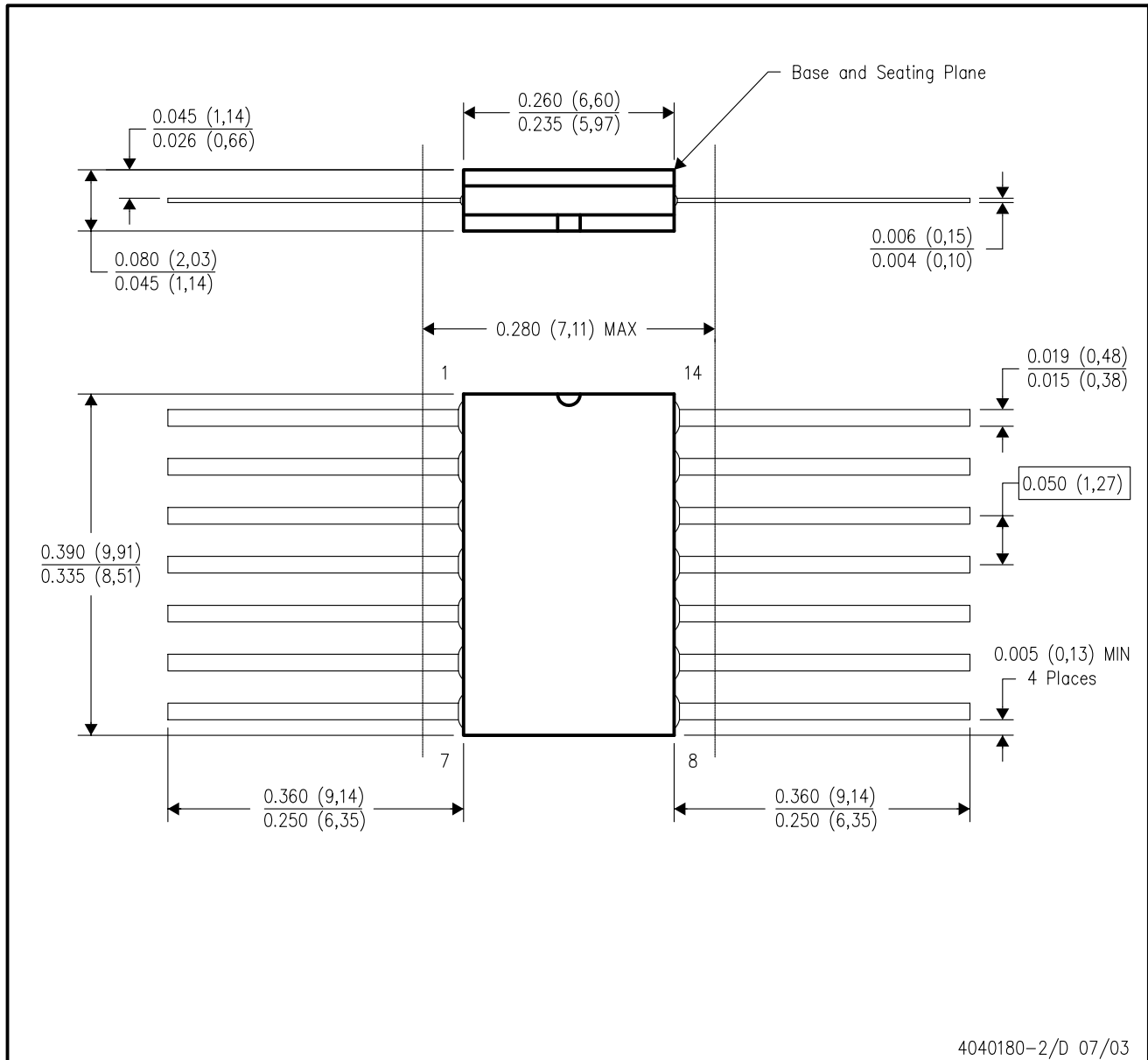

- NOTES:
- A. All linear dimensions are in inches (millimeters).
 - B. This drawing is subject to change without notice.
 - C. This package can be hermetically sealed with a ceramic lid using glass frit.
 - D. Index point is provided on cap for terminal identification only.
 - E. Falls within MIL STD 1835 GDFP1-F14 and JEDEC MO-092AB

FK (S-CQCC-N**)

LEADLESS CERAMIC CHIP CARRIER

28 TERMINAL SHOWN

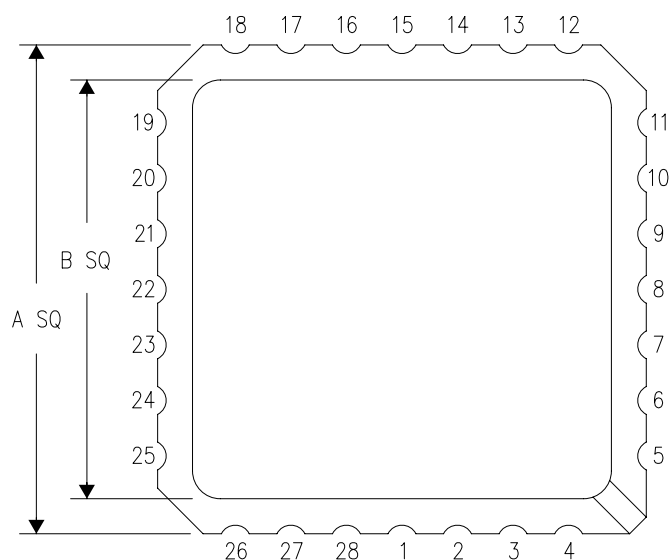

NO. OF TERMINALS **	A		B	
	MIN	MAX	MIN	MAX
20	0.342 (8,69)	0.358 (9,09)	0.307 (7,80)	0.358 (9,09)
28	0.442 (11,23)	0.458 (11,63)	0.406 (10,31)	0.458 (11,63)
44	0.640 (16,26)	0.660 (16,76)	0.495 (12,58)	0.560 (14,22)
52	0.740 (18,78)	0.761 (19,32)	0.495 (12,58)	0.560 (14,22)
68	0.938 (23,83)	0.962 (24,43)	0.850 (21,6)	0.858 (21,8)
84	1.141 (28,99)	1.165 (29,59)	1.047 (26,6)	1.063 (27,0)

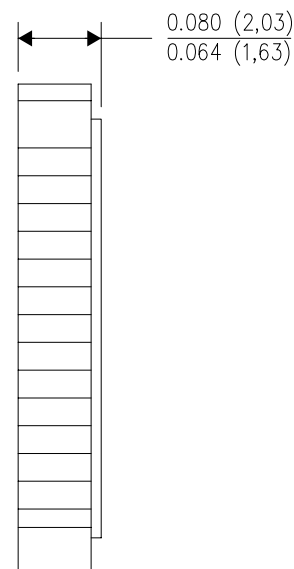
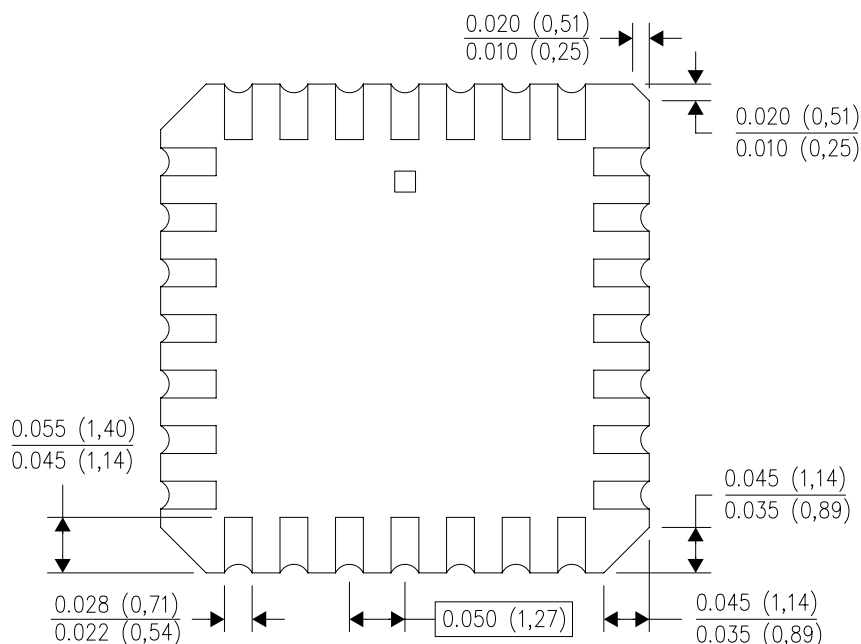

4040140/D 01/11

- NOTES:
- A. All linear dimensions are in inches (millimeters).
 - B. This drawing is subject to change without notice.
 - C. This package can be hermetically sealed with a metal lid.
 - D. Falls within JEDEC MS-004

P (R-PDIP-T8)

PLASTIC DUAL-IN-LINE PACKAGE

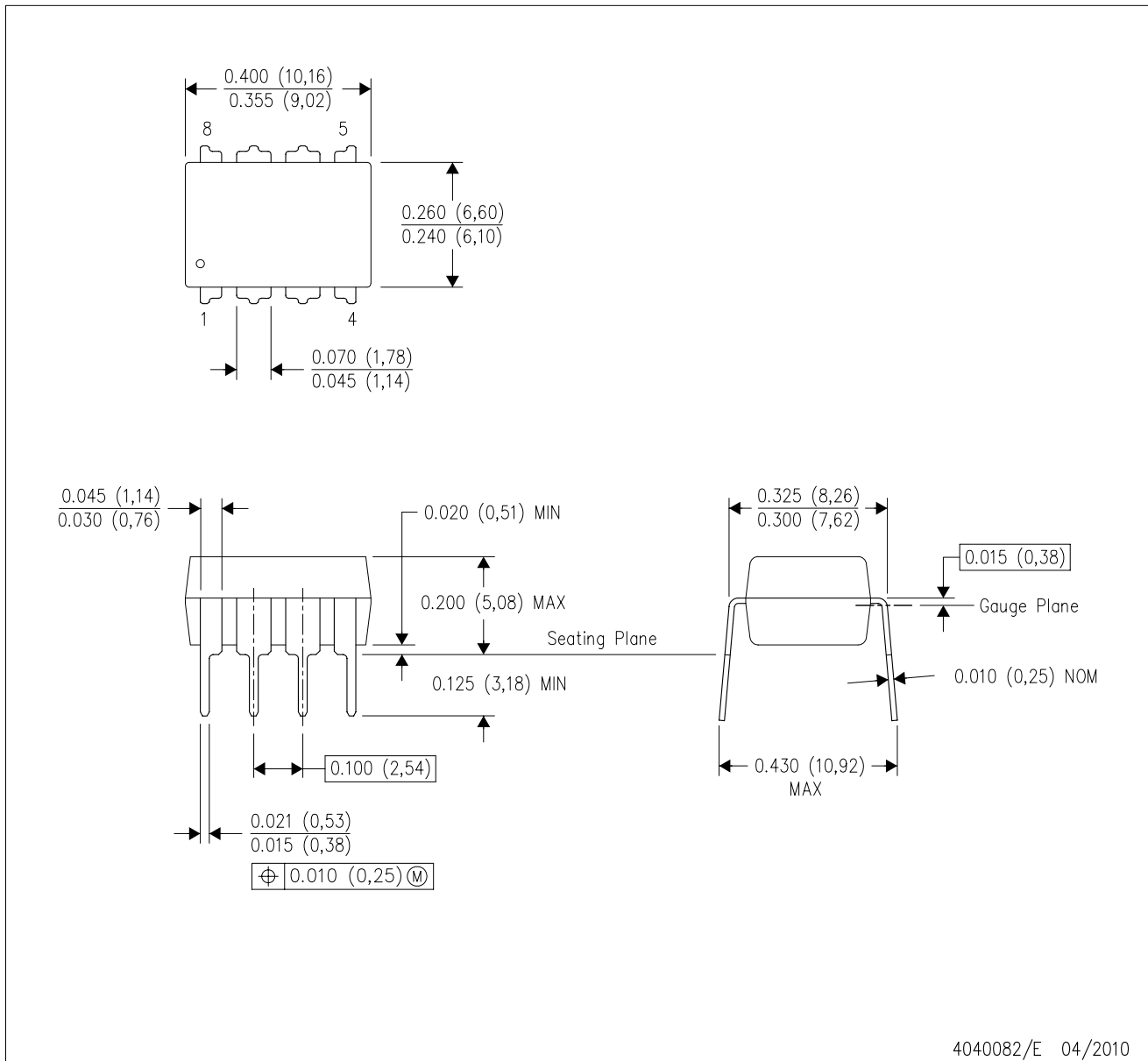



4040082/E 04/2010

- NOTES:
- A. All linear dimensions are in inches (millimeters).
 - B. This drawing is subject to change without notice.
 - C. Falls within JEDEC MS-001 variation BA.

D (R-PDSO-G14)

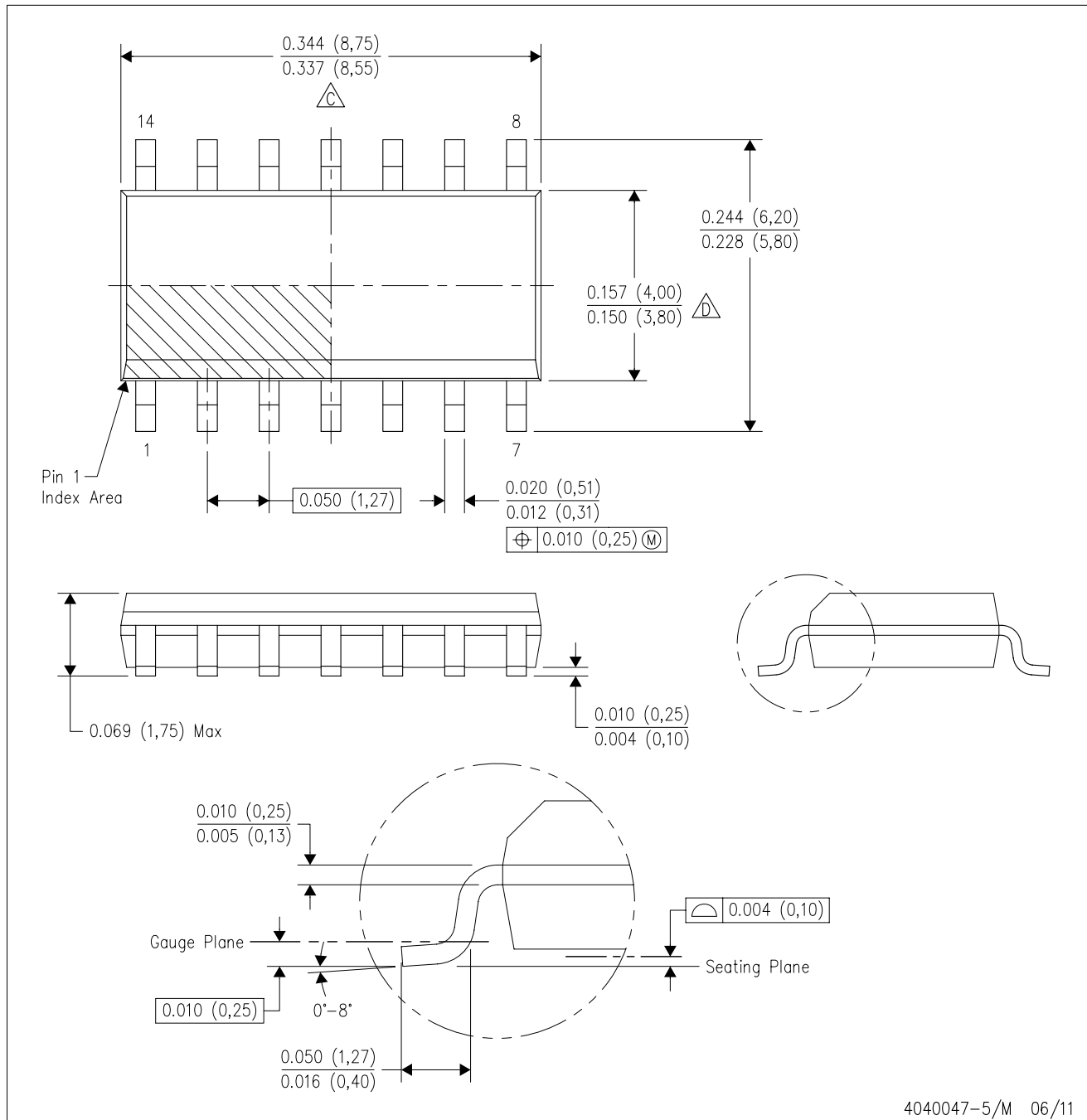
PLASTIC SMALL OUTLINE





- NOTES:
- A. All linear dimensions are in inches (millimeters).
 - B. This drawing is subject to change without notice.
 -  Body length does not include mold flash, protrusions, or gate burrs. Mold flash, protrusions, or gate burrs shall not exceed 0.006 (0,15) each side.
 -  Body width does not include interlead flash. Interlead flash shall not exceed 0.017 (0,43) each side.
 - E. Reference JEDEC MS-012 variation AB.

PW (R-PDSO-G14)

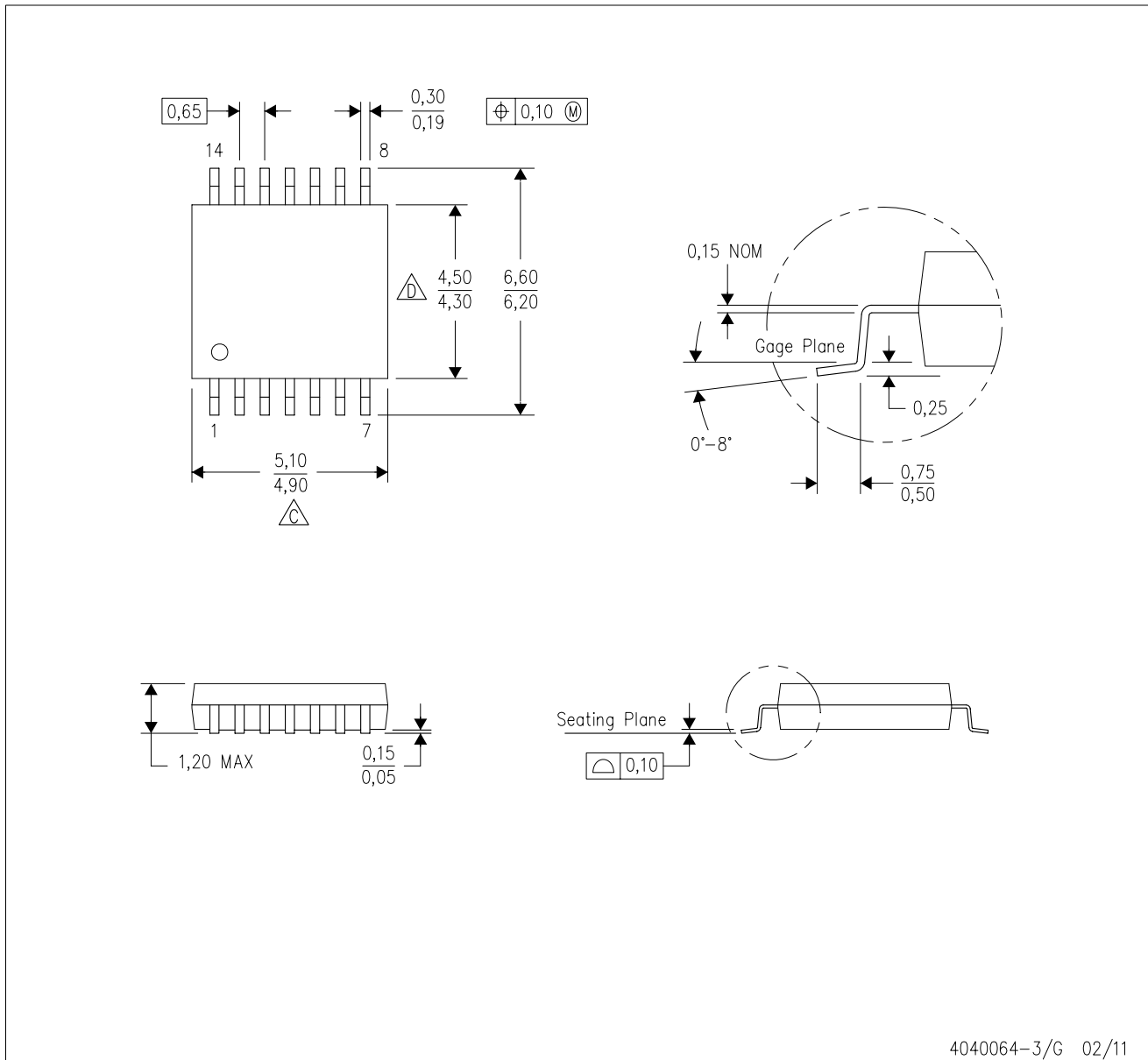
PLASTIC SMALL OUTLINE



4040064-3/G 02/11

- NOTES:
- A. All linear dimensions are in millimeters. Dimensioning and tolerancing per ASME Y14.5M-1994.
 - B. This drawing is subject to change without notice.
 -  C. Body length does not include mold flash, protrusions, or gate burrs. Mold flash, protrusions, or gate burrs shall not exceed 0,15 each side.
 -  D. Body width does not include interlead flash. Interlead flash shall not exceed 0,25 each side.
 - E. Falls within JEDEC MO-153

PW (R-PDSO-G14)

PLASTIC SMALL OUTLINE

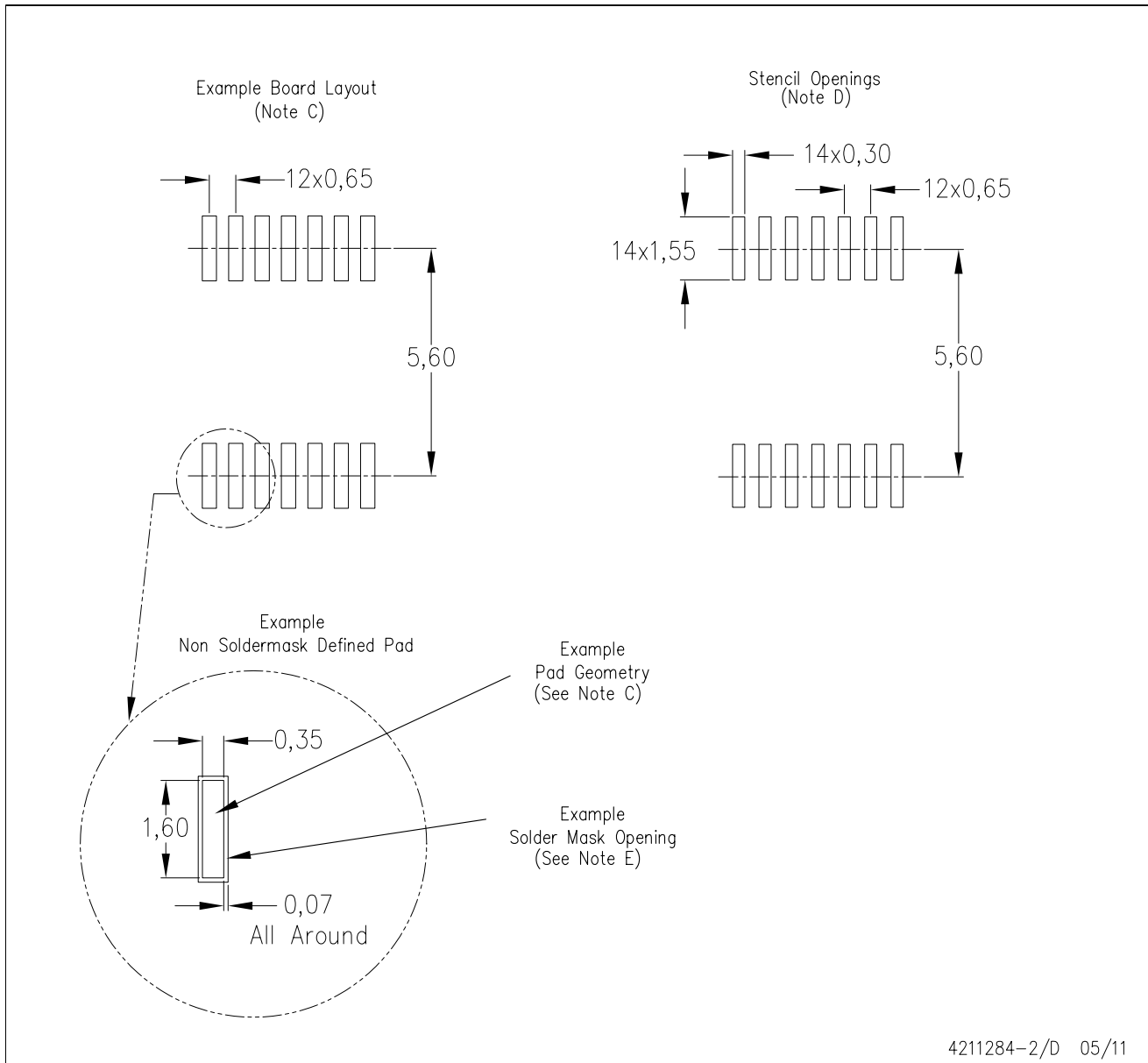

- NOTES:
- All linear dimensions are in millimeters.
 - This drawing is subject to change without notice.
 - Publication IPC-7351 is recommended for alternate designs.
 - Laser cutting apertures with trapezoidal walls and also rounding corners will offer better paste release. Customers should contact their board assembly site for stencil design recommendations. Refer to IPC-7525 for other stencil recommendations.
 - Customers should contact their board fabrication site for solder mask tolerances between and around signal pads.

PW (R-PDSO-G28)

PLASTIC SMALL OUTLINE

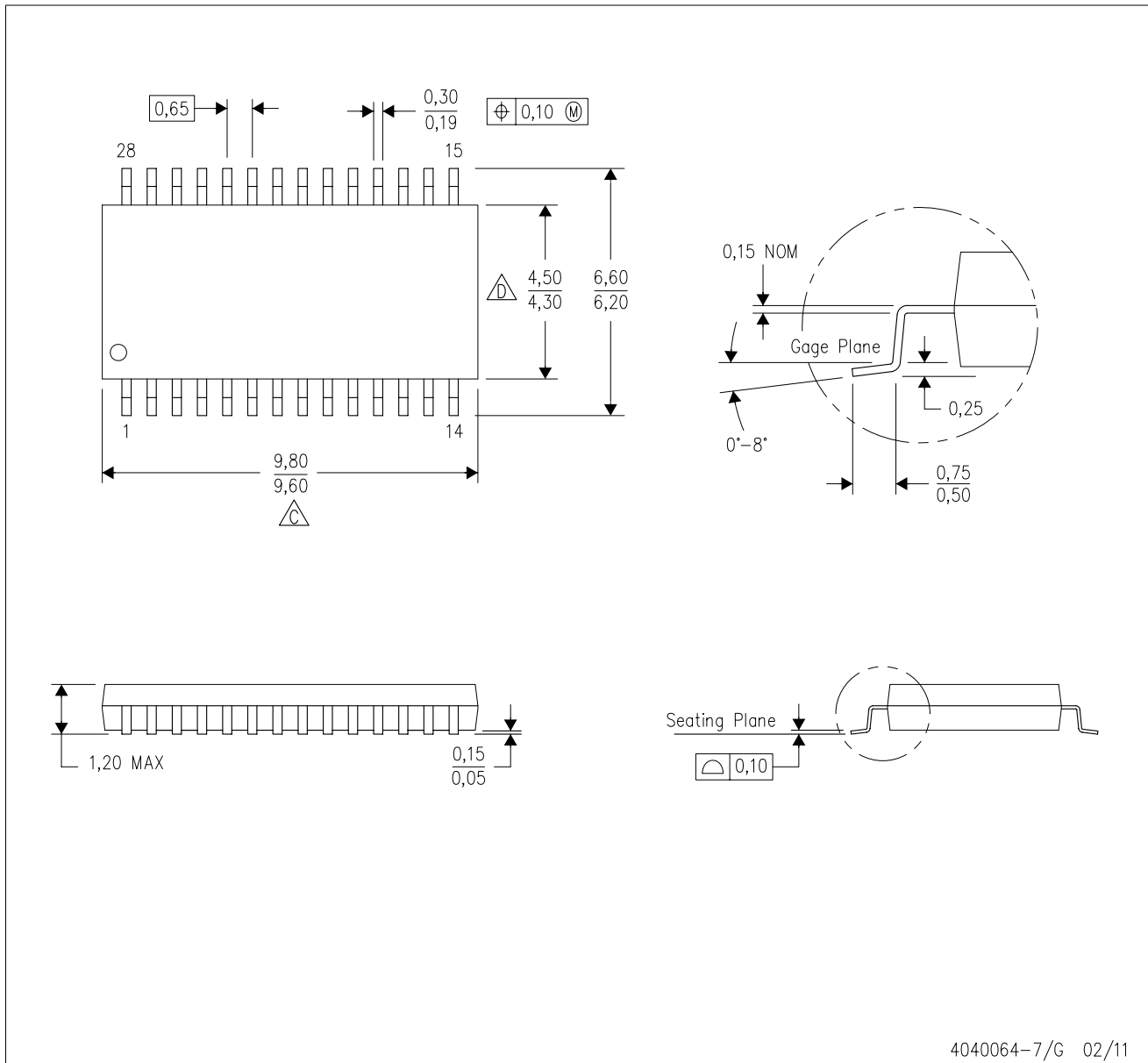

4040064-7/G 02/11

- NOTES:
- A. All linear dimensions are in millimeters. Dimensioning and tolerancing per ASME Y14.5M-1994.
 - B. This drawing is subject to change without notice.
 - C. Body length does not include mold flash, protrusions, or gate burrs. Mold flash, protrusions, or gate burrs shall not exceed 0,15 each side.
 - D. Body width does not include interlead flash. Interlead flash shall not exceed 0,25 each side.
 - E. Falls within JEDEC MO-153

D (R-PDSO-G8)

PLASTIC SMALL OUTLINE

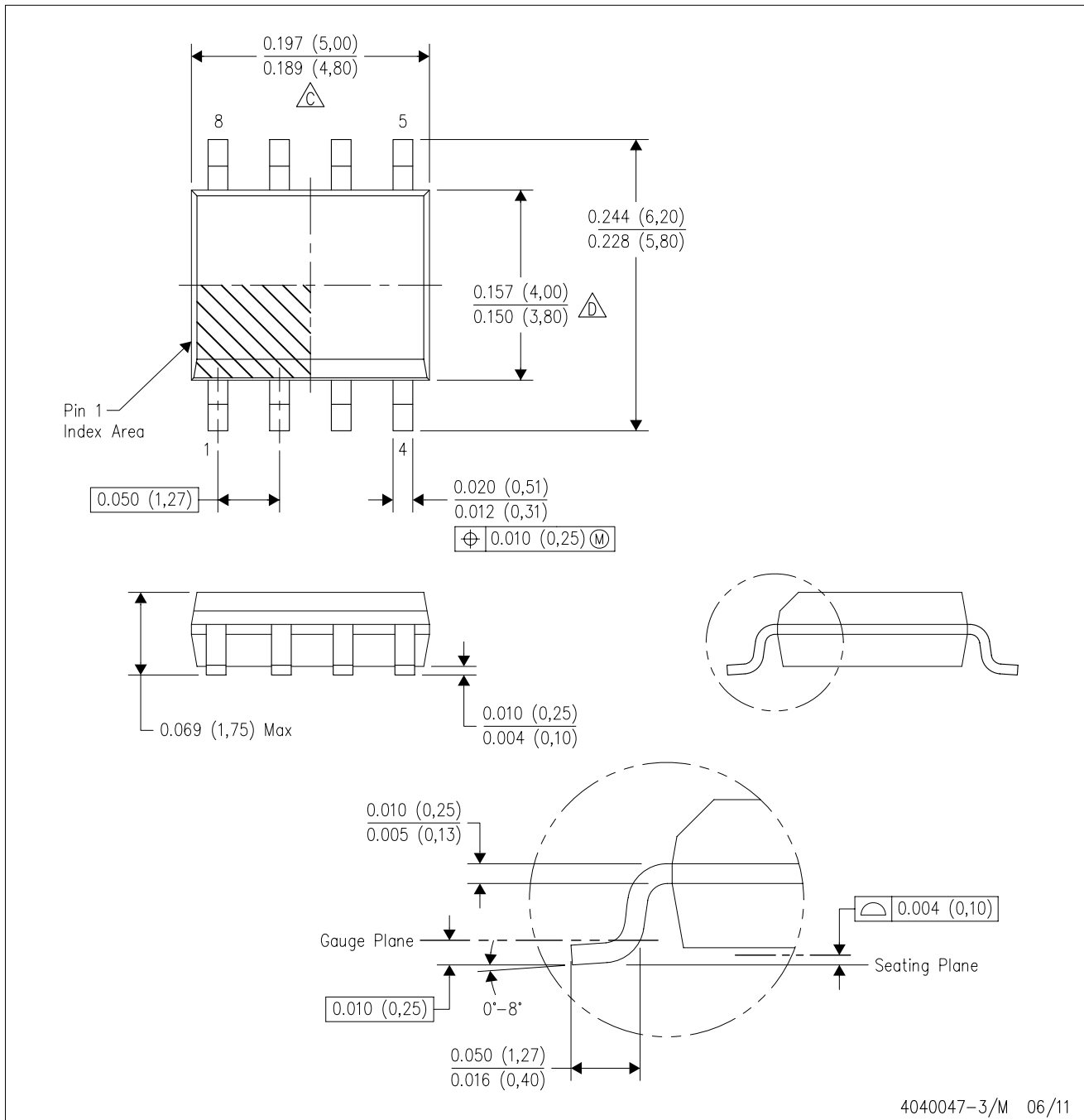

NOTES: A. All linear dimensions are in inches (millimeters).
 B. This drawing is subject to change without notice.
 C. Body length does not include mold flash, protrusions, or gate burrs. Mold flash, protrusions, or gate burrs shall not exceed 0.006 (0,15) each side.
 D. Body width does not include interlead flash. Interlead flash shall not exceed 0.017 (0,43) each side.
 E. Reference JEDEC MS-012 variation AA.

D (R-PDSO-G8)

PLASTIC SMALL OUTLINE

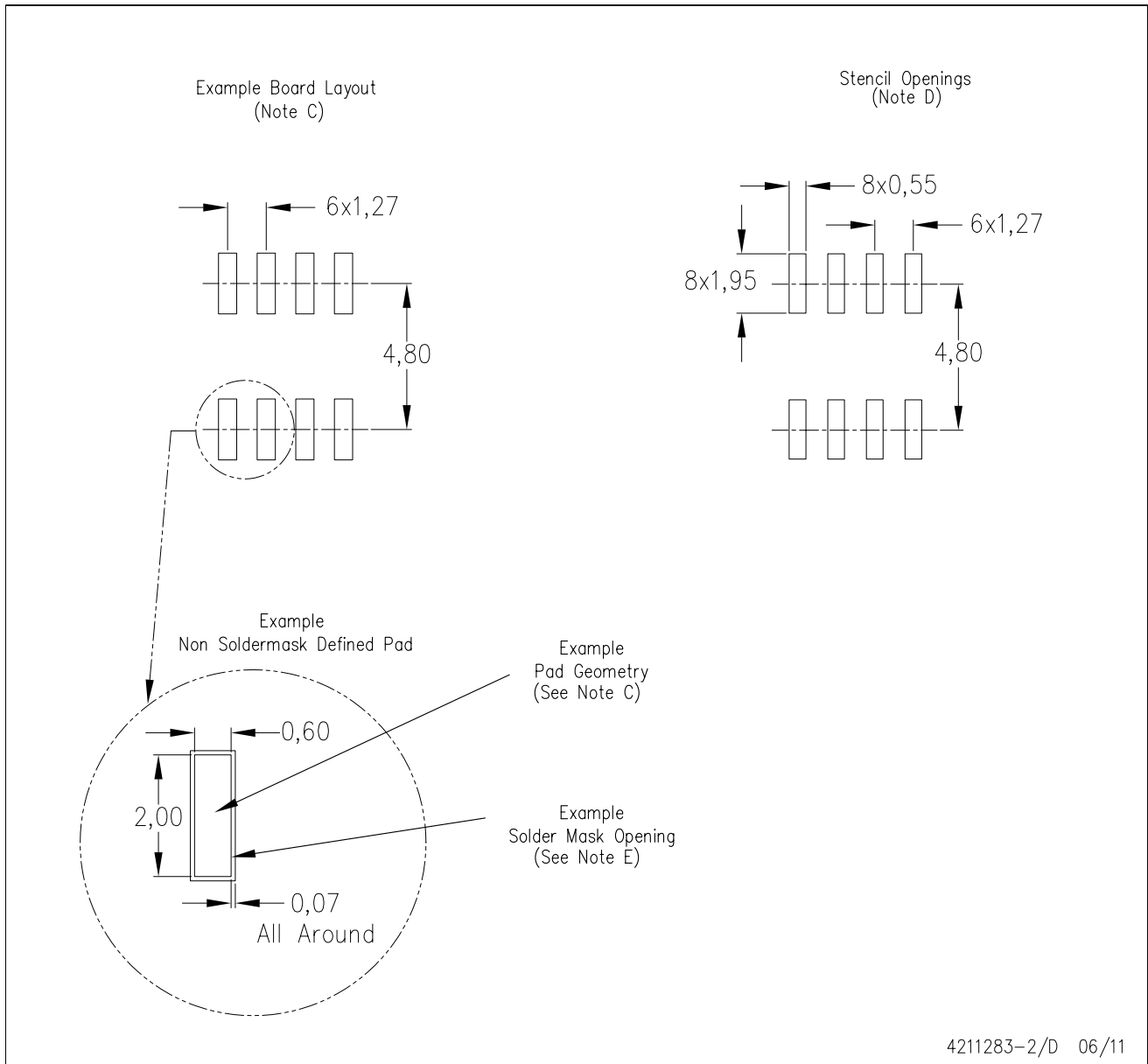

- NOTES:
- A. All linear dimensions are in millimeters.
 - B. This drawing is subject to change without notice.
 - C. Publication IPC-7351 is recommended for alternate designs.
 - D. Laser cutting apertures with trapezoidal walls and also rounding corners will offer better paste release. Customers should contact their board assembly site for stencil design recommendations. Refer to IPC-7525 for other stencil recommendations.
 - E. Customers should contact their board fabrication site for solder mask tolerances between and around signal pads.

PW (R-PDSO-G8)

PLASTIC SMALL OUTLINE

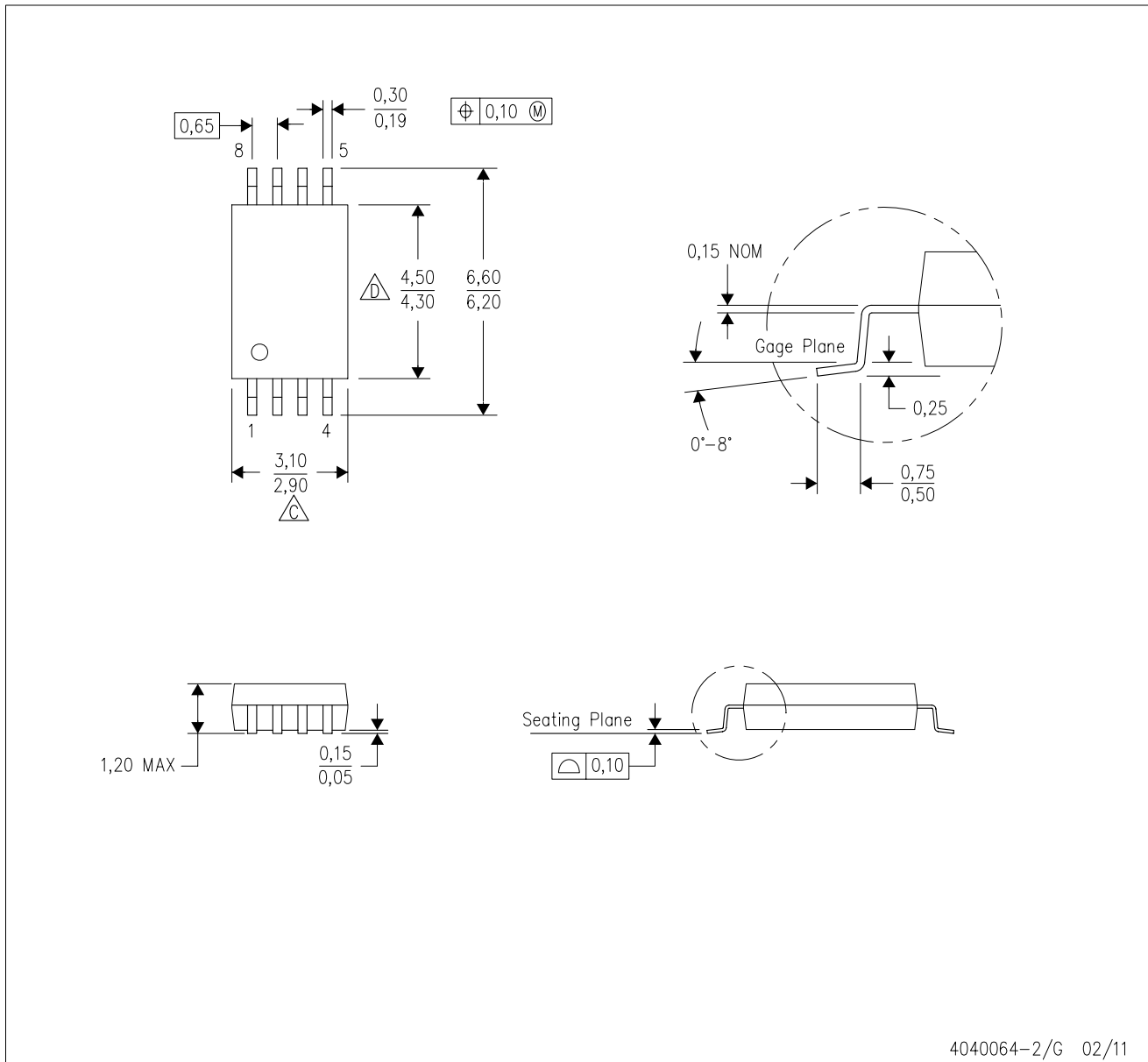

4040064-2/G 02/11

- NOTES:
- A. All linear dimensions are in millimeters. Dimensioning and tolerancing per ASME Y14.5M-1994.
 - B. This drawing is subject to change without notice.
 - C. Body length does not include mold flash, protrusions, or gate burrs. Mold flash, protrusions, or gate burrs shall not exceed 0,15 each side.
 - D. Body width does not include interlead flash. Interlead flash shall not exceed 0,25 each side.
 - E. Falls within JEDEC MO-153

IMPORTANT NOTICE

Texas Instruments Incorporated and its subsidiaries (TI) reserve the right to make corrections, modifications, enhancements, improvements, and other changes to its products and services at any time and to discontinue any product or service without notice. Customers should obtain the latest relevant information before placing orders and should verify that such information is current and complete. All products are sold subject to TI's terms and conditions of sale supplied at the time of order acknowledgment.

TI warrants performance of its hardware products to the specifications applicable at the time of sale in accordance with TI's standard warranty. Testing and other quality control techniques are used to the extent TI deems necessary to support this warranty. Except where mandated by government requirements, testing of all parameters of each product is not necessarily performed.

TI assumes no liability for applications assistance or customer product design. Customers are responsible for their products and applications using TI components. To minimize the risks associated with customer products and applications, customers should provide adequate design and operating safeguards.

TI does not warrant or represent that any license, either express or implied, is granted under any TI patent right, copyright, mask work right, or other TI intellectual property right relating to any combination, machine, or process in which TI products or services are used. Information published by TI regarding third-party products or services does not constitute a license from TI to use such products or services or a warranty or endorsement thereof. Use of such information may require a license from a third party under the patents or other intellectual property of the third party, or a license from TI under the patents or other intellectual property of TI.

Reproduction of TI information in TI data books or data sheets is permissible only if reproduction is without alteration and is accompanied by all associated warranties, conditions, limitations, and notices. Reproduction of this information with alteration is an unfair and deceptive business practice. TI is not responsible or liable for such altered documentation. Information of third parties may be subject to additional restrictions.

Resale of TI products or services with statements different from or beyond the parameters stated by TI for that product or service voids all express and any implied warranties for the associated TI product or service and is an unfair and deceptive business practice. TI is not responsible or liable for any such statements.

TI products are not authorized for use in safety-critical applications (such as life support) where a failure of the TI product would reasonably be expected to cause severe personal injury or death, unless officers of the parties have executed an agreement specifically governing such use. Buyers represent that they have all necessary expertise in the safety and regulatory ramifications of their applications, and acknowledge and agree that they are solely responsible for all legal, regulatory and safety-related requirements concerning their products and any use of TI products in such safety-critical applications, notwithstanding any applications-related information or support that may be provided by TI. Further, Buyers must fully indemnify TI and its representatives against any damages arising out of the use of TI products in such safety-critical applications.

TI products are neither designed nor intended for use in military/aerospace applications or environments unless the TI products are specifically designated by TI as military-grade or "enhanced plastic." Only products designated by TI as military-grade meet military specifications. Buyers acknowledge and agree that any such use of TI products which TI has not designated as military-grade is solely at the Buyer's risk, and that they are solely responsible for compliance with all legal and regulatory requirements in connection with such use.

TI products are neither designed nor intended for use in automotive applications or environments unless the specific TI products are designated by TI as compliant with ISO/TS 16949 requirements. Buyers acknowledge and agree that, if they use any non-designated products in automotive applications, TI will not be responsible for any failure to meet such requirements.

Following are URLs where you can obtain information on other Texas Instruments products and application solutions:

Products

Audio	www.ti.com/audio
Amplifiers	amplifier.ti.com
Data Converters	dataconverter.ti.com
DLP® Products	www.dlp.com
DSP	dsp.ti.com
Clocks and Timers	www.ti.com/clocks
Interface	interface.ti.com
Logic	logic.ti.com
Power Mgmt	power.ti.com
Microcontrollers	microcontroller.ti.com
RFID	www.ti-rfid.com
OMAP Mobile Processors	www.ti.com/omap
Wireless Connectivity	www.ti.com/wirelessconnectivity

Applications

Communications and Telecom	www.ti.com/communications
Computers and Peripherals	www.ti.com/computers
Consumer Electronics	www.ti.com/consumer-apps
Energy and Lighting	www.ti.com/energy
Industrial	www.ti.com/industrial
Medical	www.ti.com/medical
Security	www.ti.com/security
Space, Avionics and Defense	www.ti.com/space-avionics-defense
Transportation and Automotive	www.ti.com/automotive
Video and Imaging	www.ti.com/video

TI E2E Community Home Page

e2e.ti.com

Mailing Address: Texas Instruments, Post Office Box 655303, Dallas, Texas 75265
Copyright © 2011, Texas Instruments Incorporated

www.BDTIC.com/TI